



LTCC SURFACE MOUNT

Low Pass Filter

LFCG-2750+

50Ω DC to 2750 MHz

THE BIG DEAL

- Insertion Loss, Typ. 1.2 dB
- Stopband Rejection, Typ. 50 dB
- Passband Return Loss, Typ. 16 dB
- 0805 Surface Mount Footprint
- Power Handling: 4.5 Watts



Generic photo used for illustration purposes only

APPLICATIONS

- Harmonic Rejection
- Military Radar Applications
- Test and Measurement Equipment
- Telecommunications & Broadband Wireless Application

FUNCTIONAL DIAGRAM

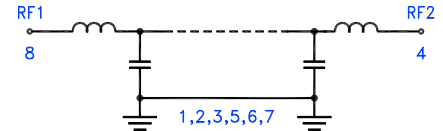

PRODUCT OVERVIEW

Mini-Circuits' LFCG-2750+ is a miniature low temperature co-fired ceramic (LTCC) low pass filter with a DC to 2750 MHz passband supporting a variety of applications. This model provides 1.2 dB typical insertion loss over a wide band due to its rugged monolithic construction. Housed in an 0805 ceramic form factor which is ideal for dense signal chain PCB layouts where it complements MMIC size and performance. The LTCC fabrication process assures minimal RF performance variation while delivering a product that is well suited for environmental extremes of high humidity and temperature.

KEY FEATURES

Features	Advantages
Ultra-wide Stopband	The LTCC lowpass filter provides a very good stopband rejection until 16 GHz suitable for wide band applications.
LTCC Construction	Provides repeatable performance in a rugged, ceramic package well suited for tough environments such as high humidity and temperature extremes.
Small Size, 0805	Saves space in dense circuit board layouts and minimizes the effects of parasitics.
Rugged Power Handling, 4.5 Watts	Handles up to 4.5 Watts in a small 0805 package.



ELECTRICAL SPECIFICATIONS^{1,2,3} AT +25°C

Parameter		F#	Frequency (MHz)	Min.	Typ.	Max.	Units
Passband	Insertion Loss	DC-F1	DC - 2750	—	1.2	2.0	dB
	Freq. Cut-Off ⁴	Fc	3150	—	3.0	—	dB
	Return Loss	DC-F1	DC - 2750	—	16	—	dB
Stopband	Rejection	F2-F3	4000 - 4350	20	50	—	dB
		F3-F4	4350 - 7200	38	50	—	
		F4-F5	7200 - 10000	—	30	—	
		F5-F6	10000 - 16000	—	25	—	

1. Tested in Evaluation Board P/N TB-LFCG-2750+.
2. This filter is bi-directional, RF1 and RF2 ports may be interchanged. See S-Parameters for actual performance.
3. In applications where DC voltage and/or current is present at either the input or output ports, external DC blocking capacitors are required.
4. Typical variation ± 5%.

ABSOLUTE MAXIMUM RATINGS⁵

Parameter	Ratings
Operating Temperature	-55°C to +125°C
Storage Temperature	-55°C to +125°C
Input Power ⁶	4.5 W @ +25°C

5. Permanent damage may occur if any of these limits are exceeded.
6. Power rating applies only to signals within the passband. Power rating above +25°C operating temperature decreases linearly to 1 W at +125°C.

TYPICAL FREQUENCY RESPONSE AT +25°C

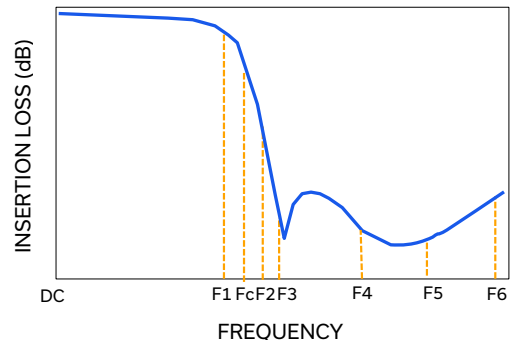



TYPICAL PERFORMANCE GRAPHS

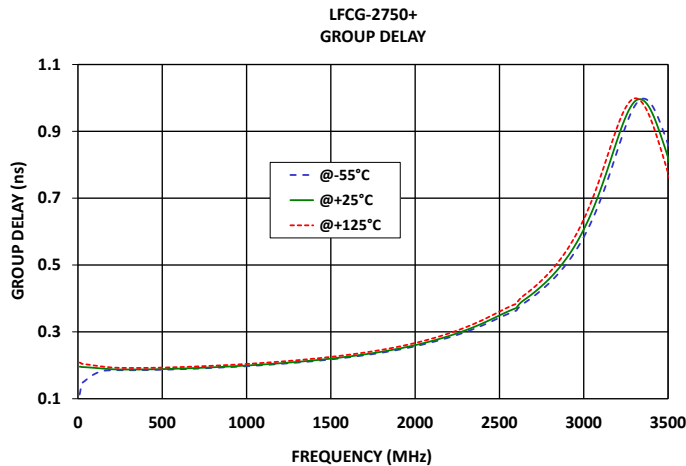
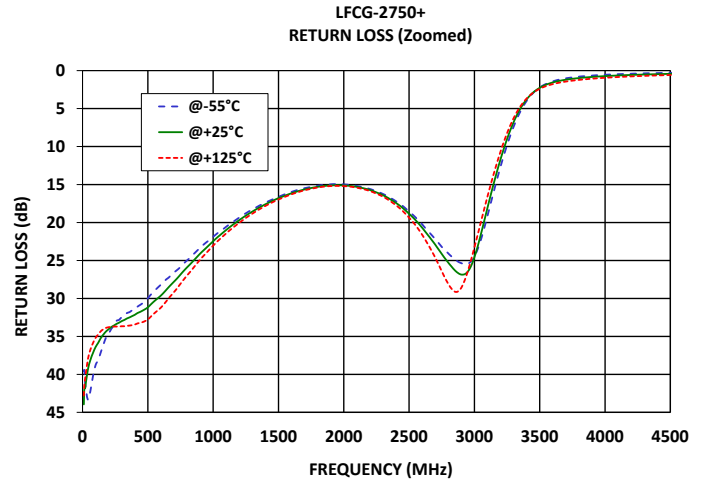
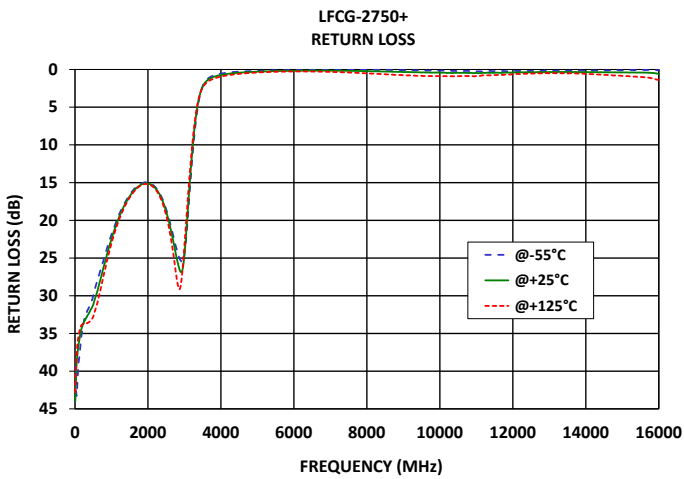
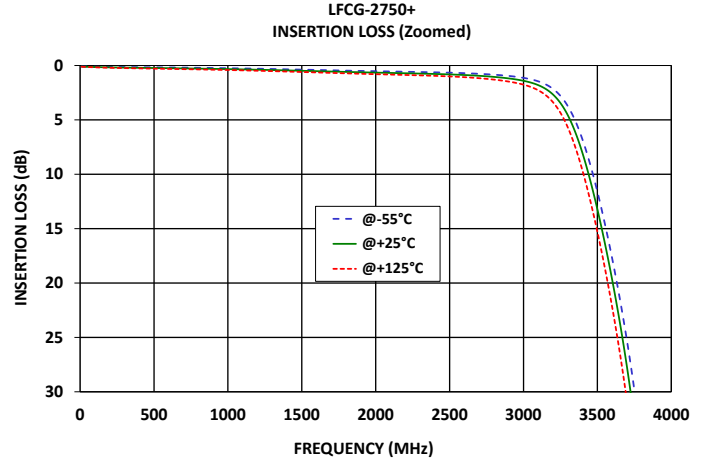
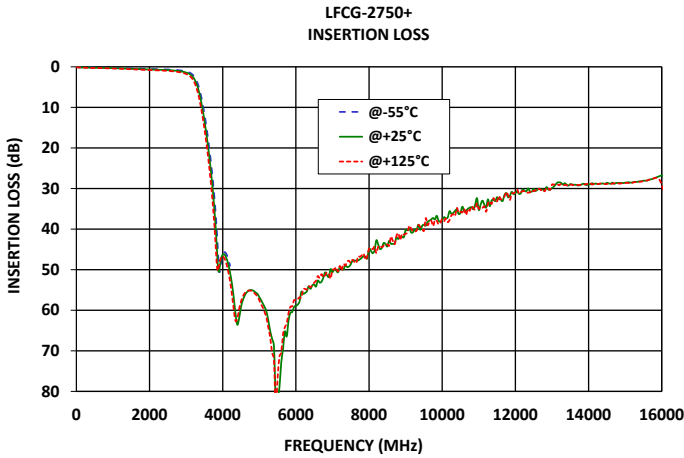



FUNCTIONAL DIAGRAM

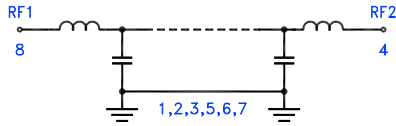
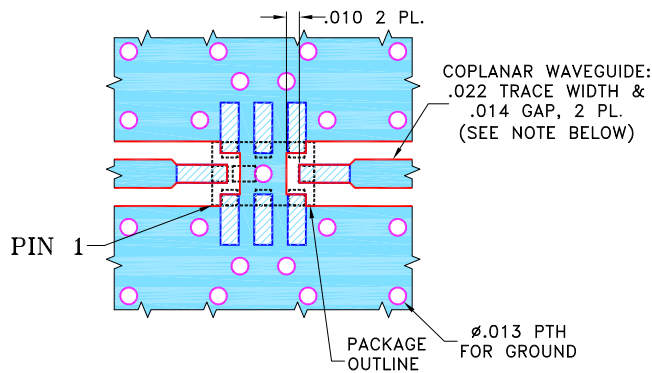

Figure 1. LFCG-2750+ Functional Diagram

PAD DESCRIPTION

Function	Pad Number	Description
RF1 ²	8	Connects to RF Input Port
RF2 ²	4	Connects to RF Output Port
GROUND	1,2,3,5,6,7	Connects to Ground on PCB, (See drawing PL-429)

SUGGESTED PCB LAYOUT (PL-429)



NOTES:

1. COPLANAR WAVEGUIDE IS SHOWN FOR ROGERS R04350B WITH DIELECTRIC THICKNESS .010" ± .001". COPPER: 1/2 OZ. EACH SIDE. FOR OTHER MATERIALS TRACE WIDTH AND GAP MAY NEED TO BE MODIFIED.
2. BOTTOM SIDE OF THE PCB IS CONTINUOUS GROUND PLANE.

- DENOTES PCB COPPER LAYOUT WITH SMOBC (SOLDER MASK OVER BARE COPPER).
- DENOTES COPPER LAND PATTERN FREE OF SOLDER MASK.

Figure 2. Suggested PCB Layout PL-429

CASE STYLE DRAWING

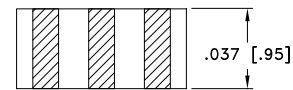
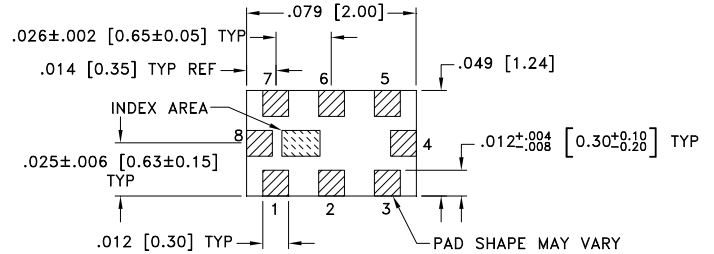

Weight: .008 grams

Dimensions are in inches (mm). Tolerances: 2Pl. ± .01; 3 Pl. ± .005

PRODUCT MARKING*: MB

*Marking may contain other features or characters for internal lot control.



LTCC SURFACE MOUNT

Low Pass Filter

LFCG-2750+

Mini-Circuits

50Ω DC to 2750 MHz

ADDITIONAL DETAILED INFORMATION IS AVAILABLE ON OUR DASHBOARD.

[CLICK HERE](#)

Performance Data and Graphs	Data
	Graphs
	S-Parameter (S2P Files) Data Set (.zip file) De-embedded to device pads
Case Style	GE0805C-2 Lead Finish: Tin over Nickel plating
RoHS Status	Compliant
Tape and Reel	F114
Suggested Layout for PCB Design	PL-429
Evaluation Board	TB-LFCG-2750+
	Gerber File
Environmental Rating	ENV06

NOTES

- A. Performance and quality attributes and conditions not expressly stated in this specification document are intended to be excluded and do not form a part of this specification document.
- B. Electrical specifications and performance data contained in this specification document are based on Mini-Circuits' applicable established test performance criteria and measurement instructions.
- C. The parts covered by this specification document are subject to Mini-Circuits' standard limited warranty and terms and conditions (collectively, "Standard Terms"); Purchasers of this part are entitled to the rights and benefits contained therein. For a full statement of the standard terms and the exclusive rights and remedies thereunder, please visit Mini-Circuits' website at www.minicircuits.com/terms/viewterm.html



Typical Performance Data

FREQ. (MHz)	INSERTION LOSS			INPUT RETURN LOSS			OUTPUT RETURN LOSS		
	(dB)			(dB)			(dB)		
	@-55°C	@+25°C	@+125°C	@-55°C	@+25°C	@+125°C	@-55°C	@+25°C	@+125°C
10	0.09	0.10	0.11	39.57	43.95	42.79	38.52	42.20	41.13
40	0.09	0.11	0.13	43.30	39.45	38.10	44.30	39.72	38.43
100	0.11	0.14	0.17	38.77	36.40	35.19	37.52	35.51	34.42
160	0.12	0.16	0.19	36.09	34.75	34.06	34.65	33.34	32.67
200	0.13	0.17	0.21	34.66	34.05	33.79	32.75	32.15	31.77
280	0.14	0.19	0.23	32.82	33.19	33.71	30.27	30.20	30.19
300	0.14	0.19	0.24	32.45	32.99	33.66	29.87	29.78	29.81
400	0.15	0.21	0.26	31.45	32.16	33.44	28.11	27.88	27.96
460	0.16	0.22	0.28	30.63	31.60	33.12	27.03	26.87	26.95
520	0.17	0.23	0.29	29.55	30.84	32.45	25.92	25.86	25.91
580	0.18	0.24	0.31	28.51	29.92	31.52	24.95	24.97	25.05
640	0.19	0.25	0.32	27.50	28.89	30.40	24.01	24.05	24.14
700	0.19	0.27	0.33	26.59	27.80	29.17	23.23	23.26	23.37
760	0.20	0.28	0.35	25.64	26.65	27.84	22.42	22.44	22.55
820	0.21	0.29	0.36	24.69	25.57	26.58	21.71	21.74	21.83
880	0.22	0.30	0.38	23.66	24.47	25.31	21.00	21.05	21.11
940	0.24	0.32	0.40	22.72	23.45	24.15	20.36	20.42	20.46
1000	0.25	0.33	0.41	21.88	22.47	23.05	19.74	19.78	19.80
1060	0.26	0.35	0.43	21.06	21.55	22.05	19.22	19.21	19.21
1120	0.28	0.36	0.45	20.30	20.71	21.13	18.67	18.65	18.63
1180	0.29	0.38	0.47	19.59	19.93	20.30	18.16	18.15	18.11
1240	0.30	0.40	0.50	18.89	19.21	19.52	17.68	17.68	17.61
1300	0.32	0.42	0.52	18.28	18.56	18.84	17.27	17.26	17.17
1360	0.34	0.44	0.54	17.72	17.96	18.20	16.87	16.85	16.74
2000	0.52	0.65	0.80	14.98	15.12	15.21	15.09	15.07	14.91
2500	0.66	0.82	1.00	18.55	18.85	19.36	17.73	17.92	18.36
2750	0.80	0.99	1.23	23.21	24.14	26.41	20.36	20.51	20.90
2800	0.84	1.05	1.30	24.07	25.29	28.09	20.78	20.83	20.92
2900	0.96	1.19	1.48	25.36	26.86	28.58	21.20	20.79	20.03
3000	1.13	1.41	1.76	24.48	24.57	23.27	19.71	18.78	17.44
3150	1.73	2.15	2.73	15.82	14.73	13.47	13.17	12.23	11.17
3200	2.15	2.67	3.38	12.65	11.67	10.66	10.74	9.91	9.07
3220	2.38	2.95	3.73	11.47	10.55	9.64	9.83	9.05	8.30
3600	17.75	19.71	22.22	1.41	1.56	1.78	2.27	2.58	2.99
3605	18.09	20.07	22.61	1.39	1.53	1.75	2.26	2.56	2.98
3730	27.95	30.56	34.01	0.94	1.12	1.36	2.01	2.33	2.71
4000	46.30	46.28	46.70	0.54	0.72	0.94	1.42	1.65	1.89
4200	49.03	50.68	52.82	0.41	0.57	0.76	1.02	1.20	1.38
4300	54.48	56.78	59.61	0.36	0.51	0.69	0.87	1.03	1.18
4350	58.32	60.83	62.67	0.34	0.49	0.66	0.80	0.96	1.11
5000	56.18	56.74	57.51	0.18	0.29	0.40	0.35	0.47	0.58
5500	78.35	81.70	76.74	0.11	0.22	0.30	0.23	0.35	0.48
6000	57.79	58.93	57.53	0.06	0.17	0.26	0.17	0.30	0.48
6200	56.43	55.93	54.75	0.05	0.16	0.26	0.15	0.30	0.49
6400	55.20	54.72	54.32	0.04	0.15	0.27	0.15	0.30	0.52
6550	52.01	54.16	52.71	0.03	0.15	0.28	0.15	0.31	0.53
6600	53.16	52.68	51.57	0.02	0.15	0.28	0.15	0.31	0.54
6850	51.02	51.37	50.64	0.02	0.15	0.30	0.14	0.32	0.57
7000	51.66	50.61	50.03	0.01	0.16	0.32	0.14	0.32	0.59
7200	49.99	49.40	49.08	0.02	0.16	0.35	0.15	0.34	0.62
7300	49.73	49.99	48.58	0.02	0.17	0.37	0.15	0.34	0.63
7500	47.37	48.68	48.32	0.02	0.18	0.40	0.16	0.36	0.65
8000	45.13	44.83	44.82	0.04	0.22	0.51	0.16	0.38	0.69
10000	36.67	37.83	37.53	0.16	0.42	0.89	0.07	0.24	0.41
12000	30.70	31.16	30.79	0.20	0.38	0.64	0.02	0.15	0.33
13000	29.79	29.86	29.01	0.16	0.33	0.51	0.02	0.25	0.64
14000	28.74	28.95	28.92	0.15	0.36	0.58	0.08	0.21	0.66
15000	28.46	28.55	28.70	0.11	0.39	0.86	0.09	0.22	0.76
15500	28.09	28.06	28.17	0.07	0.41	0.99	0.10	0.24	0.79
16000	26.87	26.80	29.17	0.11	0.61	1.36	0.08	0.31	0.87

Typical Performance Data

FREQ. (MHz)	GROUP DELAY		
	(nsec)		
	@-55°C	@+25°C	@+125°C
10	0.11	0.20	0.21
80	0.17	0.19	0.20
100	0.17	0.19	0.20
200	0.19	0.19	0.19
260	0.19	0.19	0.19
320	0.19	0.19	0.19
380	0.19	0.19	0.19
440	0.19	0.19	0.19
500	0.19	0.19	0.19
560	0.19	0.19	0.19
620	0.19	0.19	0.19
680	0.19	0.19	0.20
740	0.19	0.19	0.20
800	0.19	0.19	0.20
860	0.19	0.20	0.20
920	0.20	0.20	0.20
980	0.20	0.20	0.20
1000	0.20	0.20	0.20
1100	0.20	0.20	0.21
1160	0.20	0.20	0.21
1200	0.20	0.21	0.21
1280	0.21	0.21	0.21
1300	0.21	0.21	0.22
1400	0.21	0.21	0.22
1460	0.22	0.22	0.22
1500	0.22	0.22	0.23
1580	0.22	0.22	0.23
1600	0.22	0.23	0.23
1700	0.23	0.23	0.24
1760	0.23	0.24	0.24
1800	0.24	0.24	0.25
1880	0.24	0.25	0.25
1900	0.25	0.25	0.26
2000	0.26	0.26	0.27
2100	0.27	0.27	0.28
2200	0.28	0.29	0.30
2300	0.30	0.31	0.31
2400	0.32	0.33	0.34
2500	0.34	0.35	0.36
2700	0.41	0.42	0.43
2750	0.43	0.44	0.45

Typical Performance Curves

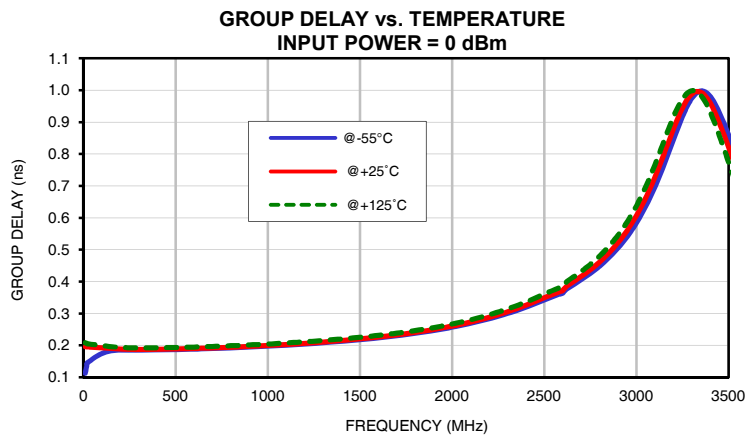
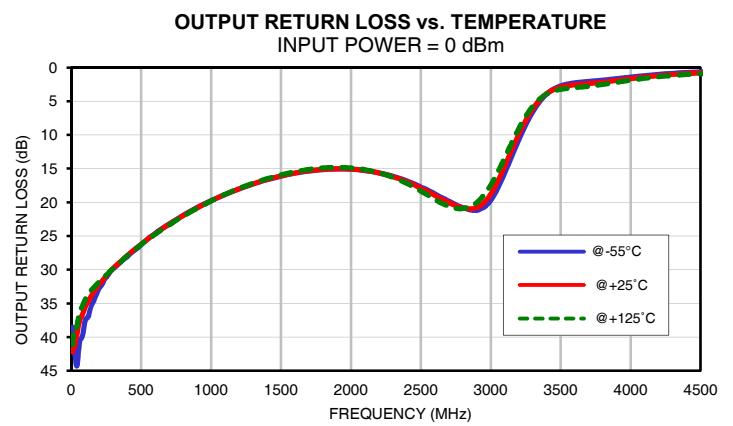
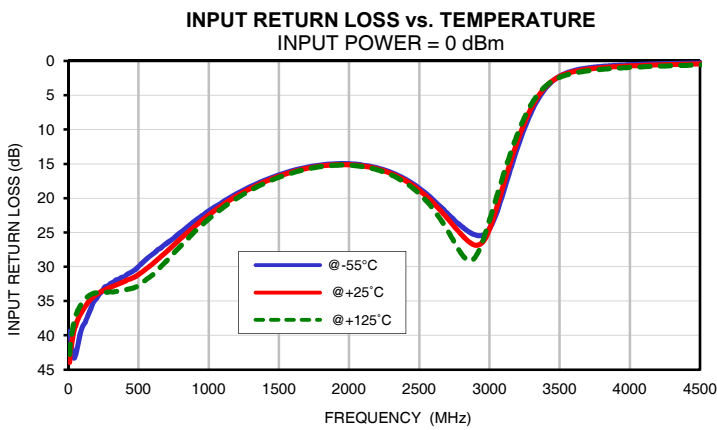
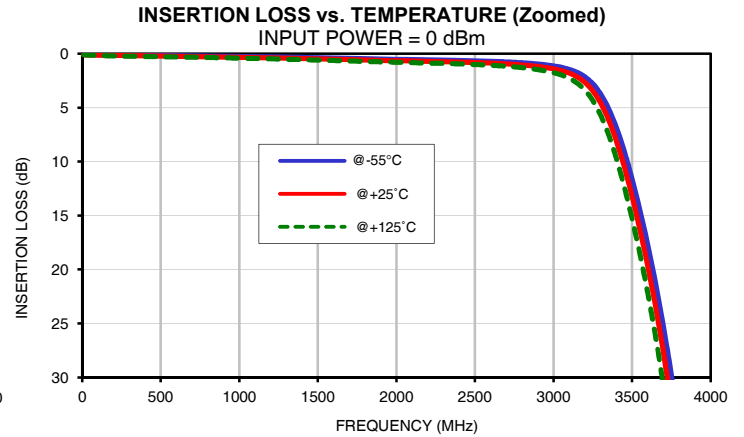
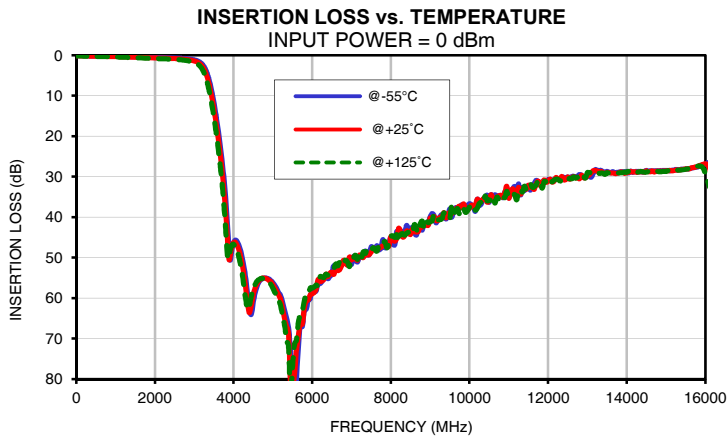

Outline Dimensions

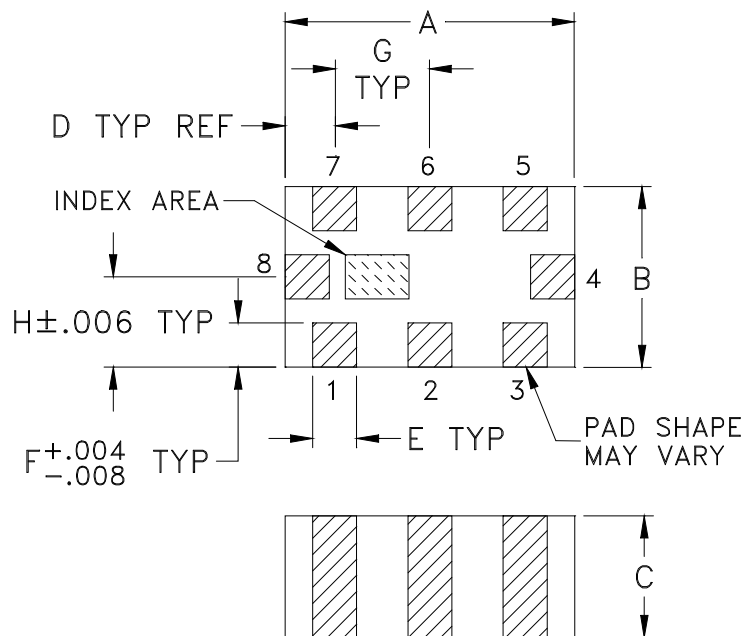

PCB Land Pattern

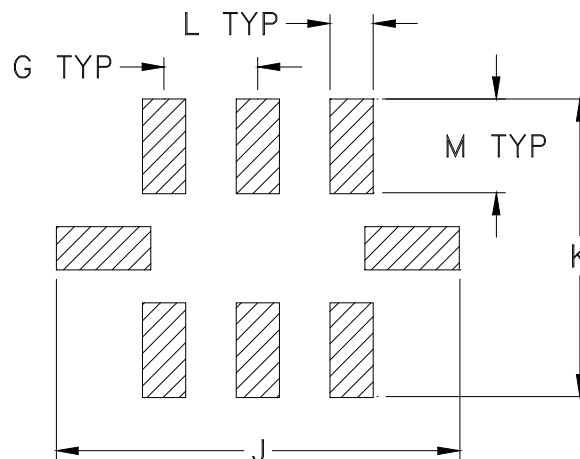

Suggested Layout,
Tolerance to be within $\pm.002$

CASE #	A	B	C	D	E	F	G	H	J	K	L
GE0805C-2	.079 (2.00)	.049 (1.25)	.037 (0.95)	.014 (0.35)	.012 (0.30)	.012 (0.30)	.026 (0.65)	.025 (0.63)	.134 (3.40)	.110 (2.80)	.014 (0.35)

CASE #	M	WT. GRAM
GE0805C-2	.039 (1.00)	.008

Dimensions are in inches (mm). Tolerances: 2Pl. $\pm .01$; 3 Pl. $\pm .005$

Notes:

1. Open style, ceramic base.
2. Termination finish: For RoHS Case Styles: Tin plate over Nickel plate. All models, (+) suffix.
For RoHS-5 Case Styles: Tin-Lead plate over Nickel plate. All models, no (+) suffix.
3. Pad tolerance to be non-cumulative. Minimum spacing between each pad is .004 (0.1).



P.O. Box 350166, Brooklyn, New York 11235-0003 (718) 934-4500 Fax (718) 332-4661 For detailed performance specs & shopping online see Mini-Circuits web site



Provides ACTUAL Data Instantly From MINI-CIRCUITS At: www.minicircuits.com

RF/IF MICROWAVE COMPONENTS

Tape & Reel Packaging TR-F114

DEVICE ORIENTATION IN T&R



ILLUSTRATION 1

Applicable Case Styles	
GE0805C	JC0603C
GE0805C-1	JC0603C-4
GE0805C-1AP	JC0603C-6
GE0805C-7	
GE0805C-9	
GE0805C-10	
GE0805C-11	
GE0805C-12	

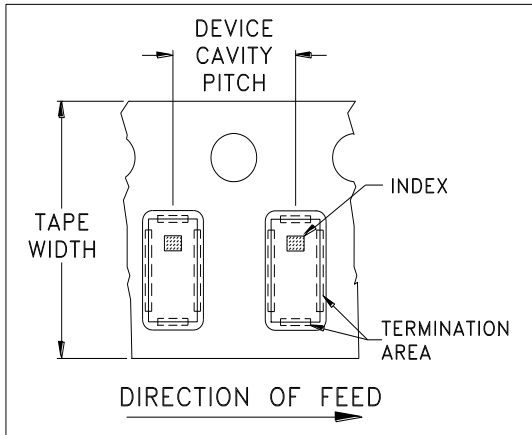

ILLUSTRATION 2

Applicable Case Styles	
GE0805C-2	JC0603C-1
GE0805C-3	JC0603C-2
GE0805C-4	JC0603C-3
GE0805C-5	JC0603C-5
GE0805C-6	JC0603C-7
GE0805C-8	
GE0805C-15	

Tape Width, mm	Device Cavity Pitch, mm	Reel Size, inches	Devices per Reel	
8	4	7	Small quantity standards (see note)	20
				50
				100
				200
				500
				1000
			Standard	4000

Note: Please Consult individual model data sheet to determine device per reel availability.

Mini-Circuits carrier tape materials provide protection from ESD (Electro-Static Discharge) during handling and transportation. Tapes are static dissipative and comply with industry standards EIA-481/EIA-541.

Go to: www.minicircuits.com/pages/pdfs/tape.pdf



INTERNET <http://www.minicircuits.com>

P.O. Box 350166, Brooklyn, New York 11235-0003 (718) 934-4500 Fax (718) 332-4661

Distribution Centers NORTH AMERICA 800-654-7949 • 417-335-5935 • Fax 417-335-5945 • EUROPE 44-1252-832600 • Fax 44-1252-837010

Mini-Circuits ISO 9001 & ISO 14001 Certified

THIRD ANGLE PROJECTION

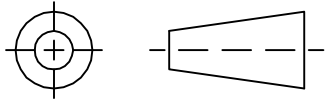

REVISIONS

REV	ECN No.	DESCRIPTION	DATE	DR	AUTH
OR	M148457	NEW RELEASE	10/14/14	GF	MY

SUGGESTED MOUNTING CONFIGURATION
FOR GE0805C-4 CASE STYLE, "08FL07" PIN CODE

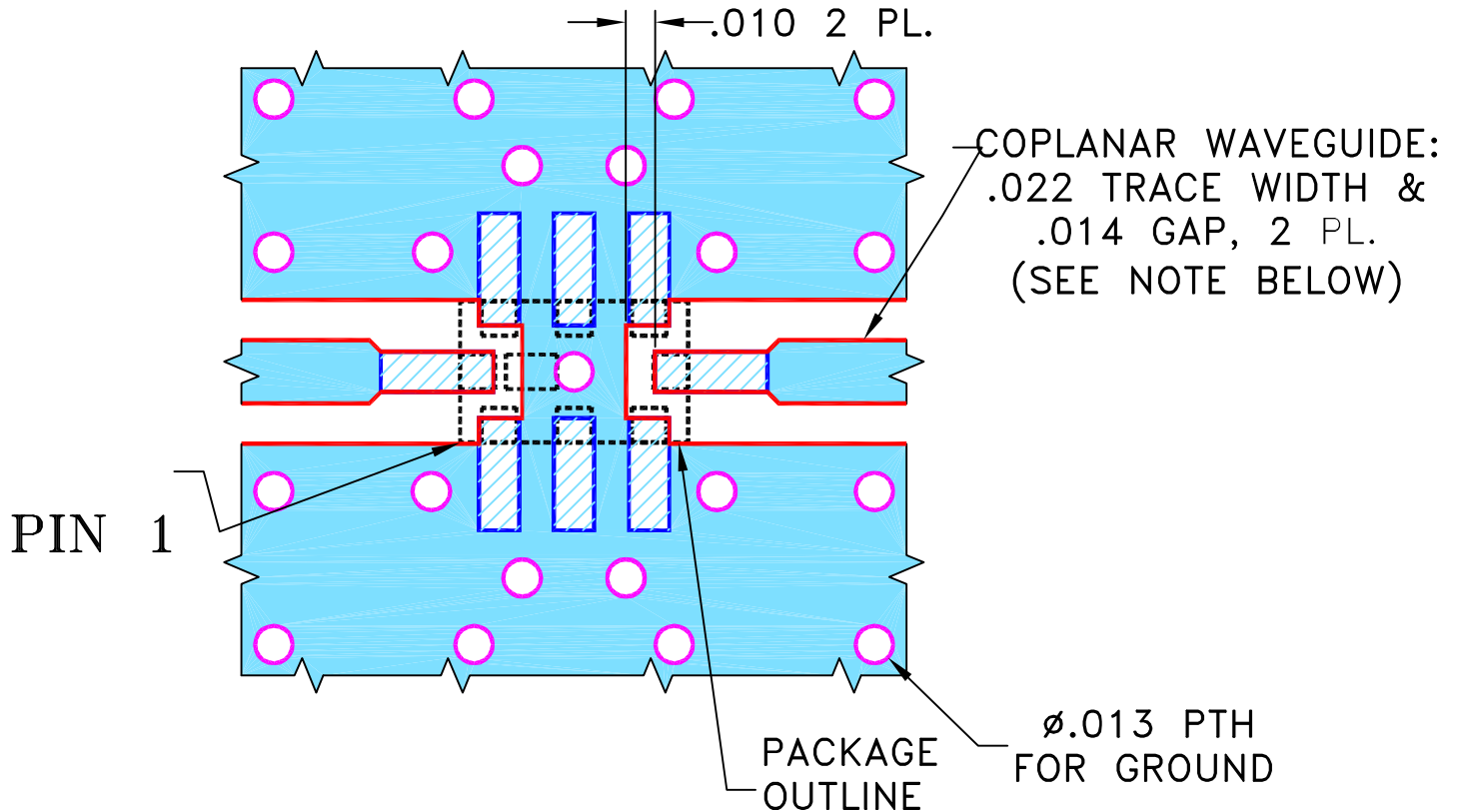

NOTES:

1. COPLANAR WAVEGUIDE IS SHOWN FOR ROGERS R04350B WITH DIELECTRIC THICKNESS .010" ± .001". COPPER: 1/2 OZ. EACH SIDE. FOR OTHER MATERIALS TRACE WIDTH AND GAP MAY NEED TO BE MODIFIED.
2. BOTTOM SIDE OF THE PCB IS CONTINUOUS GROUND PLANE.

 DENOTES PCB COPPER LAYOUT WITH SMOBC (SOLDER MASK OVER BARE COPPER).

 DENOTES COPPER LAND PATTERN FREE OF SOLDER MASK.

UNLESS OTHERWISE SPECIFIED	INITIALS	DATE
DIMENSIONS ARE IN INCHES	DRAWN GF	10/01/14
TOLERANCES ON:	CHECKED IL	10/14/14
2 PL DECIMALS ±	APPROVED MY	10/14/14
3 PL DECIMALS ± .005		
ANGLES ±		
FRACTIONS ±		

 **Mini-Circuits®** 13 Neptune Avenue
Brooklyn NY 11235

PL, 08FL07, GE0805C-4, TB-799+

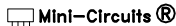
 Mini-Circuits®
THIS DOCUMENT AND ITS CONTENTS ARE THE PROPERTY OF MINI-CIRCUITS. EXCEPT FOR USE EXPRESSLY GRANTED, IN WRITING, TO ITS VENDORS, VENDEE AND THE UNITED STATES GOVERNMENT, MINI-CIRCUITS RESERVES ALL PROPRIETARY DESIGN, USE, MANUFACTURING AND REPRODUCTION RIGHTS THERETO. THESE CONTENTS SHALL NOT BE USED, DUPLICATED OR DISCLOSED TO ANY OUTSIDE PARTY, IN WHOLE OR IN PART, WITHOUT WRITTEN PERMISSION OF MINI-CIRCUITS.

SIZE	CODE IDENT	DRAWING NO:	REV:
A	15542	98-PL-429	OR
FILE:	98PL429	SCALE: 15:1	SHEET: 1 OF 1

Evaluation Board and Circuit

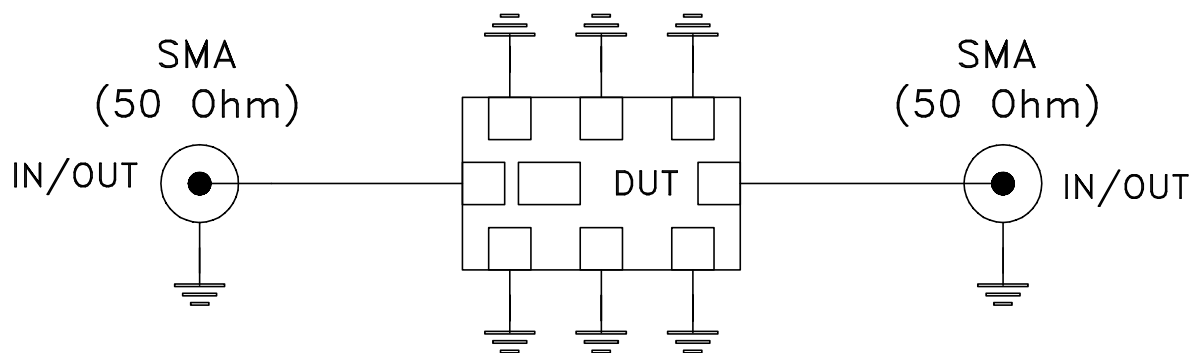
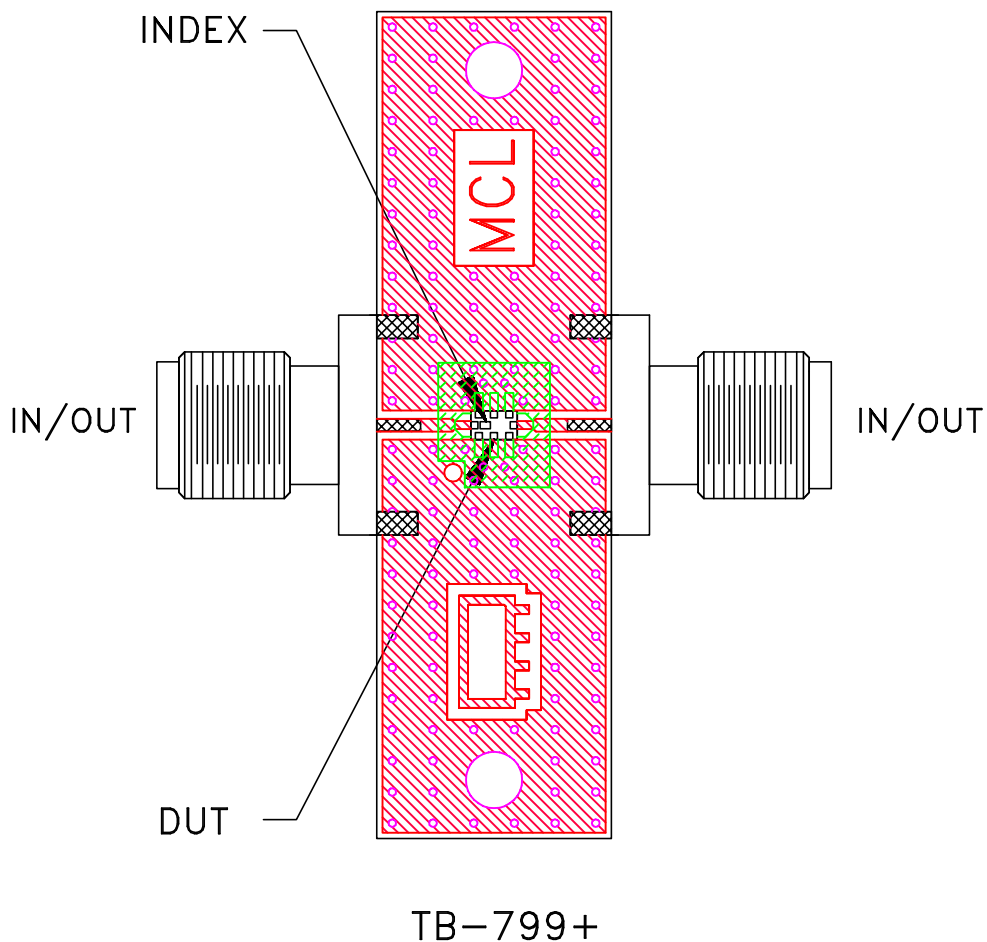

Schematic Diagram

Notes:

1. 50 Ohm SMA Female connectors.
2. PCB Material: R04350 or equivalent,
Dielectric Constant=3.5, Thickness=.010 inch.

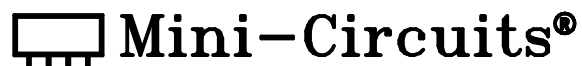

All Mini-Circuits products are manufactured under exacting quality assurance and control standards, and are capable of meeting published specifications after being subjected to any or all of the following physical and environmental test.

Specification	Test/Inspection Condition	Reference/Spec
Operating Temperature	-55° to 100°C Ambient Environment	Individual Model Data Sheet
Storage Temperature	-55° to 100° C Ambient Environment	Individual Model Data Sheet
Humidity	90 to 95% RH, 240 hours, 50°C	MIL-STD-202, Method 103, Condition A, Except 50°C and end-point electrical test done within 12 hours
Solder Reflow Heat	Sn-Pb Eutetic Process: 225°C peak Pb-Free Process 245° - 250°C peak	J-STD-020, Table 4-1, 4-2 and 5-2, Figure 5-1
Solderability	10X Magnification	J-STD-002, Para 4.2.5, Test S, 95% Coverage
Vibration (High Frequency)	20g peak, 10-2000 Hz, 12 times in each of three perpendicular directions (total 36)	MIL-STD-202, Method 204, Condition D
Mechanical Shock	50g, 11 ms, 1/2-sine, 18 shocks: 3 each direction, each of 3 axes	MIL-STD-202, Method 213, Condition A