

Ceramic Low Pass Filter

LFCG-3000+

50Ω DC to 3000 MHz



Generic photo used for illustration purposes only
CASE STYLE: GE0805C-2

The Big Deal

- Very good rejection, 50 dB typical
- Rugged, ceramic construction
- Tiny size, 0.079 x 0.049 x 0.037" (0805)
- Excellent power handling, 4.5W

Product Overview

Mini-Circuits' LFCG-3000+ is an LTCC low pass filter with a passband from DC to 3000 MHz, supporting a variety of applications. This model provides 1.1 dB typical passband insertion loss and provides a very good stopband rejection due to strategically constructed layout with minimal interaction between components. It handles up to 4.5W RF input power and provides a wide operating temperature range from -55 to +125°C. Housed in a tiny 0805 ceramic form factor with wraparound terminations, the filter is ideal for dense PCB layouts and with minimal performance variation due to parasitics.

Key Features

Feature	Advantages
Ultra-wide stopband	The LTCC lowpass filter provides a very good stopband rejection until 15 GHz suitable for high end applications.
LTCC Construction	Provides repeatable performance in a rugged, ceramic package well suited for tough environments such as high humidity and temperature extremes.
Tiny size (0.079 x 0.049 x 0.037")	Saves space in dense circuit board layouts and minimizes the effects of parasitics.
Excellent power handling, 4.5W	Supports a wide range of system power requirements.
Wrap-around terminations	Provides excellent solderability and easy visual inspection

Notes

- A. Performance and quality attributes and conditions not expressly stated in this specification document are intended to be excluded and do not form a part of this specification document.
B. Electrical specifications and performance data contained in this specification document are based on Mini-Circuit's applicable established test performance criteria and measurement instructions.
C. The parts covered by this specification document are subject to Mini-Circuits standard limited warranty and terms and conditions (collectively, "Standard Terms"); Purchasers of this part are entitled to the rights and benefits contained therein. For a full statement of the Standard Terms and the exclusive rights and remedies thereunder, please visit Mini-Circuits' website at www.minicircuits.com/MCLStore/terms.jsp



Low Pass Filter

50Ω DC to 3000 MHz

LFCG-3000+



Generic photo used for illustration purposes only

CASE STYLE: GE0805C-2

+RoHS Compliant

The +Suffix identifies RoHS Compliance. See our web site for RoHS Compliance methodologies and qualifications

Features

- Low loss, 1.1 dB typical
- High rejection 50 dB typical
- Excellent power handling, 4.5W
- Extremely small size 0805 (2.0 mm x 1.25 mm)
- Temperature stable
- LTCC construction

Applications

- Harmonic Rejection
- VHF/UHF transmitters / receivers
- Military radar applications
- Test and measurement
- Telecommunications & broadband wireless applications

Functional Schematic

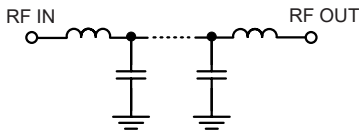

Electrical Specifications^{1,2} at 25°C

Parameter		F#	Frequency (MHz)	Min.	Typ.	Max.	Unit
Pass Band	Insertion Loss	DC-F1	DC-3000	—	1.1	2.2	dB
	Freq. Cut-Off	F2	3460	—	3.0	—	dB
	Return Loss	DC-F1	DC-3000	—	18	—	dB
Stop Band	Rejection Loss	F3-F4	4550-4800	20	50	—	dB
		F4-F5	4800-7000	38	50	—	dB
		F5-F6	7000-11000	—	30	—	dB
		F6-F7	11000-15000	—	25	—	dB

1 In Applications where DC voltage and/or current is present at either input or output ports, DC de-coupling capacitors are required. If DC pass from IN-OUT is required, please contact Mini-Circuits for alternatives.

2 Measured on Mini-Circuits Characterization Test Board TB-799+

Maximum Ratings

Operating Temperature	-55°C to 125°C
Storage Temperature	-55°C to 125°C
RF Power Input*	4.5W max. @25°C

*Passband rating, derate linearly to 1W at 125°C ambient

Permanent damage may occur if any of these limits are exceeded.

Typical Performance Data at 25°C

Frequency (MHz)	Insertion Loss (dB)	Return Loss (dB)
10	0.10	44.32
100	0.12	38.27
1000	0.33	24.69
1400	0.45	19.16
1800	0.59	16.47
2020	0.67	16.00
2500	0.84	17.98
2600	0.88	19.09
3000	1.23	24.56
3460	3.10	11.45
3480	3.35	10.56
3900	22.39	1.46
4030	32.10	1.09
4550	60.43	0.55
4800	54.97	0.44
7000	54.31	0.16
9000	40.72	0.21
11000	32.42	0.34
12000	31.15	0.32
15000	24.85	0.63

Typical Frequency Response

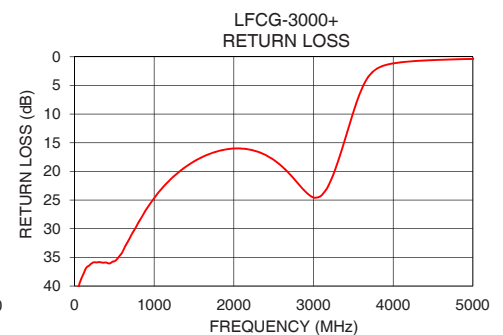
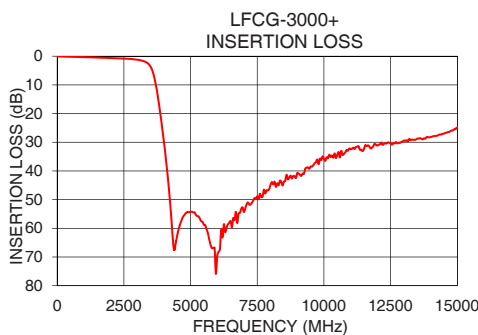
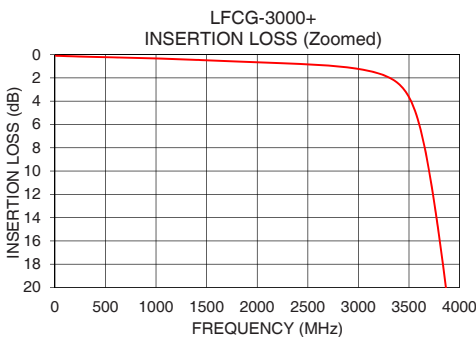
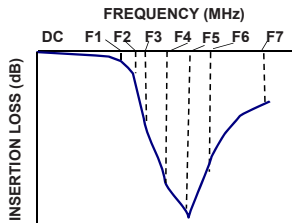

Notes

- Performance and quality attributes and conditions not expressly stated in this specification document are intended to be excluded and do not form a part of this specification document.
- Electrical specifications and performance data contained in this specification document are based on Mini-Circuit's applicable established test performance criteria and measurement instructions.
- The parts covered by this specification document are subject to Mini-Circuits standard limited warranty and terms and conditions (collectively, "Standard Terms"); Purchasers of this part are entitled to the rights and benefits contained therein. For a full statement of the Standard Terms and the exclusive rights and remedies thereunder, please visit Mini-Circuits' website at www.minicircuits.com/MCLStore/terms.jsp



Pad Connections

INPUT	8
OUTPUT	4
GROUND	1,2,3,5,6,7

Product Marking: LK

Demo Board MCL P/N: TB-799+
Suggested PCB Layout (PL-429)

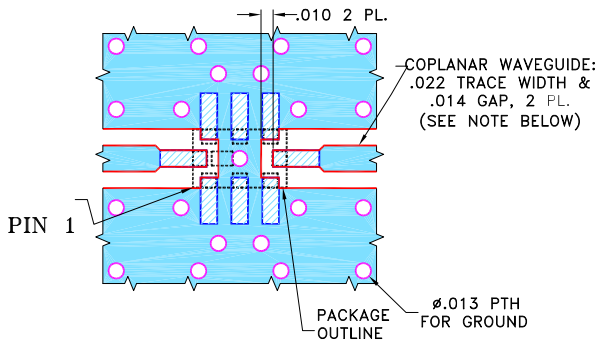

NOTES:

1. COPLANAR WAVEGUIDE IS SHOWN FOR ROGERS R04350B WITH DIELECTRIC THICKNESS $.010" \pm .001"$. COPPER: 1/2 OZ. EACH SIDE. FOR OTHER MATERIALS TRACE WIDTH AND GAP MAY NEED TO BE MODIFIED.
2. BOTTOM SIDE OF THE PCB IS CONTINUOUS GROUND PLANE.

- DENOTES PCB COPPER LAYOUT WITH SMOBC (SOLDER MASK OVER BARE COPPER).
- DENOTES COPPER LAND PATTERN FREE OF SOLDER MASK.

Outline Drawing

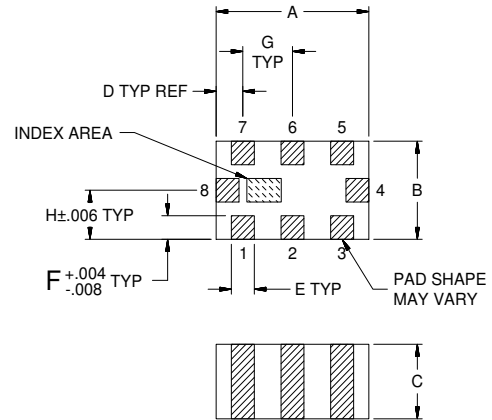

Outline Dimensions (inch / mm)

A	B	C	D	E	F	G	Wt.
.079	.049	.037	.014	.012	.012	.026	grams
2.00	1.25	0.95	0.35	0.30	0.30	0.65	.008

Note: Please refer to case style drawing for details

Notes

- A. Performance and quality attributes and conditions not expressly stated in this specification document are intended to be excluded and do not form a part of this specification document.
 B. Electrical specifications and performance data contained in this specification document are based on Mini-Circuit's applicable established test performance criteria and measurement instructions.
 C. The parts covered by this specification document are subject to Mini-Circuits standard limited warranty and terms and conditions (collectively, "Standard Terms"); Purchasers of this part are entitled to the rights and benefits contained therein. For a full statement of the Standard Terms and the exclusive rights and remedies thereunder, please visit Mini-Circuits' website at www.minicircuits.com/MCLStore/terms.jsp

Typical Performance Data

FREQ. (MHz)	INSERTION LOSS			INPUT RETURN LOSS			OUTPUT RETURN LOSS		
	(dB)			(dB)			(dB)		
	@-40°C	@+25°C	@+85°C	@-40°C	@+25°C	@+85°C	@-40°C	@+25°C	@+85°C
10	0.08	0.10	0.11	45.15	44.32	42.02	45.77	43.29	42.28
40	0.09	0.11	0.12	45.09	41.10	37.91	44.15	42.13	38.86
100	0.10	0.12	0.14	42.79	38.27	34.49	40.45	38.40	35.48
160	0.11	0.14	0.16	35.47	36.64	34.61	34.76	35.65	35.01
220	0.13	0.16	0.18	31.52	35.98	36.63	30.99	33.58	34.23
280	0.14	0.17	0.20	30.64	35.89	38.63	29.74	32.03	32.53
340	0.15	0.19	0.21	31.89	35.88	40.69	29.45	30.65	30.89
400	0.15	0.20	0.23	33.75	35.91	42.88	28.73	29.34	29.59
460	0.16	0.21	0.25	34.03	35.93	46.70	27.67	28.18	28.45
520	0.17	0.22	0.26	33.31	35.51	47.08	26.99	27.16	27.46
580	0.18	0.24	0.27	32.92	34.52	42.63	26.60	26.16	26.43
640	0.19	0.25	0.29	32.41	32.99	37.62	25.97	25.18	25.27
700	0.20	0.26	0.30	31.41	31.47	34.21	25.06	24.30	24.21
760	0.21	0.27	0.32	29.77	30.02	31.75	24.06	23.57	23.39
820	0.22	0.29	0.34	27.95	28.53	29.72	23.06	22.77	22.62
880	0.23	0.30	0.35	26.41	27.10	27.98	22.19	22.00	21.85
940	0.24	0.32	0.37	25.24	25.85	26.41	21.53	21.36	21.16
1000	0.26	0.33	0.39	24.18	24.69	24.97	20.92	20.75	20.46
1060	0.27	0.35	0.41	23.15	23.57	23.70	20.30	20.12	19.80
1120	0.29	0.36	0.43	22.18	22.62	22.63	19.70	19.58	19.22
1180	0.30	0.38	0.45	21.21	21.76	21.69	19.11	19.10	18.74
1240	0.32	0.40	0.47	20.29	20.94	20.86	18.52	18.62	18.27
1300	0.34	0.42	0.49	19.54	20.22	20.15	17.97	18.17	17.83
1360	0.35	0.44	0.51	18.93	19.57	19.48	17.60	17.80	17.46
1500	0.39	0.49	0.56	17.91	18.26	18.15	17.07	17.03	16.72
1600	0.42	0.52	0.60	17.20	17.53	17.47	16.61	16.62	16.30
1780	0.47	0.58	0.66	16.47	16.56	16.60	16.30	16.12	15.91
2000	0.54	0.66	0.75	15.99	16.00	16.13	16.28	16.03	15.92
2100	0.57	0.69	0.79	16.06	16.03	16.19	16.55	16.27	16.25
2200	0.59	0.73	0.82	16.25	16.21	16.41	16.94	16.66	16.74
3000	1.02	1.23	1.41	24.90	24.56	23.72	27.71	28.84	28.75
3400	2.10	2.53	2.90	15.42	14.21	13.38	16.45	15.48	14.72
3460	2.56	3.10	3.58	12.59	11.45	10.73	14.15	13.19	12.60
3480	2.76	3.35	3.88	11.66	10.56	9.89	13.41	12.46	11.94
3900	20.08	22.39	24.34	1.35	1.46	1.59	2.74	2.87	2.97
4030	29.41	32.10	34.35	0.95	1.09	1.22	1.98	2.10	2.18
4550	62.04	60.43	59.38	0.43	0.55	0.64	0.80	0.90	0.95
4700	56.99	56.28	55.98	0.36	0.48	0.55	0.65	0.76	0.80
4800	55.32	54.97	54.90	0.33	0.44	0.51	0.58	0.70	0.74
5650	60.26	61.71	62.35	0.15	0.25	0.31	0.29	0.43	0.52
5800	64.03	66.85	69.44	0.12	0.23	0.29	0.26	0.40	0.51
5950	70.30	75.84	70.84	0.10	0.22	0.28	0.22	0.38	0.50
6000	68.62	69.47	70.92	0.11	0.22	0.29	0.22	0.38	0.51
6250	59.46	58.57	57.33	0.08	0.20	0.28	0.18	0.36	0.52
6400	59.79	58.63	56.82	0.05	0.18	0.27	0.14	0.34	0.50
6550	59.91	59.59	57.74	0.04	0.18	0.27	0.12	0.33	0.51
6600	57.32	56.45	55.35	0.04	0.18	0.28	0.12	0.33	0.52
6850	55.76	54.61	55.16	0.02	0.17	0.29	0.09	0.33	0.54
7000	53.48	54.31	52.71	0.00	0.16	0.29	0.07	0.31	0.54
7150	51.77	50.97	51.01	0.02	0.16	0.32	0.06	0.31	0.57
7300	49.63	51.10	51.41	0.01	0.17	0.33	0.07	0.33	0.58
7450	50.59	49.78	48.83	0.03	0.16	0.35	0.04	0.30	0.58
7500	48.75	48.86	48.84	0.04	0.16	0.35	0.04	0.30	0.58
7600	48.70	47.97	46.61	0.05	0.16	0.36	0.02	0.29	0.58
8000	45.88	44.78	44.93	0.06	0.17	0.41	0.00	0.29	0.59
9000	40.60	40.72	41.25	0.05	0.21	0.53	0.12	0.13	0.40
10000	35.99	35.73	35.68	0.05	0.27	0.55	0.21	0.06	0.08
11000	33.71	32.42	32.97	0.16	0.34	0.57	0.24	0.13	0.06
12000	31.36	31.15	30.79	0.16	0.32	0.45	0.27	0.12	0.01
15000	25.12	24.85	25.17	0.07	0.63	1.42	0.05	0.19	0.48

Typical Performance Data

FREQ. (MHz)	GROUP DELAY		
	(nsec)		
	@-40°C	@+25°C	@+85°C
10	0.22	0.19	0.22
80	0.20	0.19	0.19
140	0.20	0.19	0.18
200	0.19	0.19	0.18
260	0.19	0.18	0.18
320	0.19	0.18	0.18
380	0.19	0.18	0.18
440	0.19	0.18	0.18
500	0.19	0.18	0.18
560	0.19	0.19	0.18
620	0.19	0.19	0.18
680	0.20	0.19	0.18
740	0.20	0.19	0.18
800	0.20	0.19	0.18
860	0.20	0.19	0.18
920	0.20	0.19	0.19
980	0.20	0.19	0.19
1040	0.20	0.19	0.19
1100	0.21	0.20	0.19
1160	0.21	0.20	0.19
1220	0.21	0.20	0.19
1280	0.21	0.20	0.20
1340	0.21	0.20	0.20
1400	0.22	0.21	0.20
1460	0.22	0.21	0.20
1520	0.22	0.21	0.21
1580	0.22	0.21	0.21
1640	0.23	0.22	0.21
1700	0.23	0.22	0.22
1760	0.23	0.22	0.22
1820	0.24	0.23	0.22
1880	0.24	0.23	0.23
1940	0.25	0.24	0.23
2000	0.25	0.24	0.24
2060	0.26	0.25	0.24
2120	0.26	0.25	0.25
2180	0.27	0.26	0.26
2240	0.28	0.27	0.26
2500	0.31	0.31	0.30
2700	0.35	0.35	0.35
3000	0.44	0.44	0.44

Typical Performance Curves

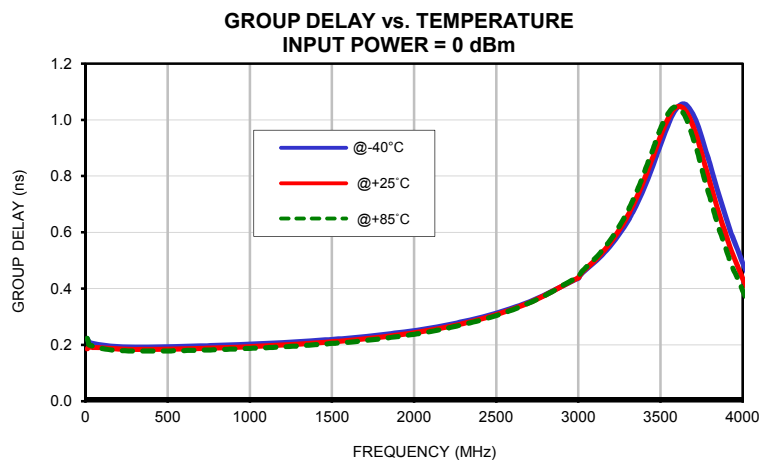
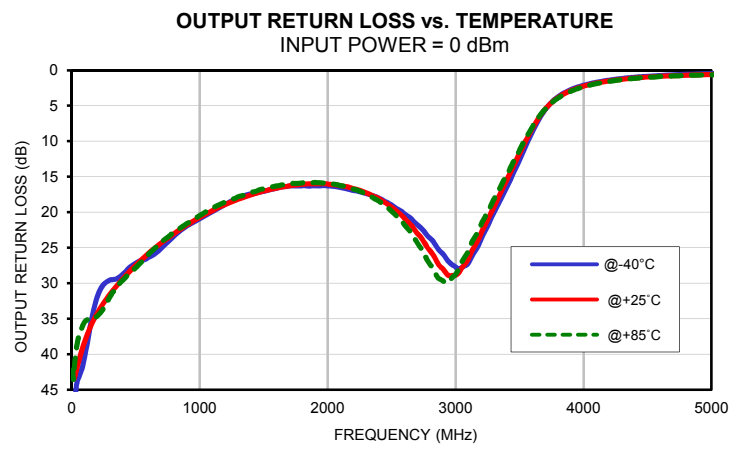
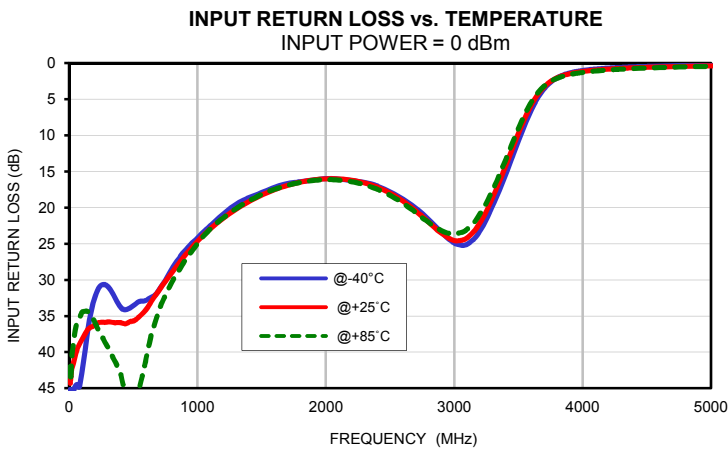
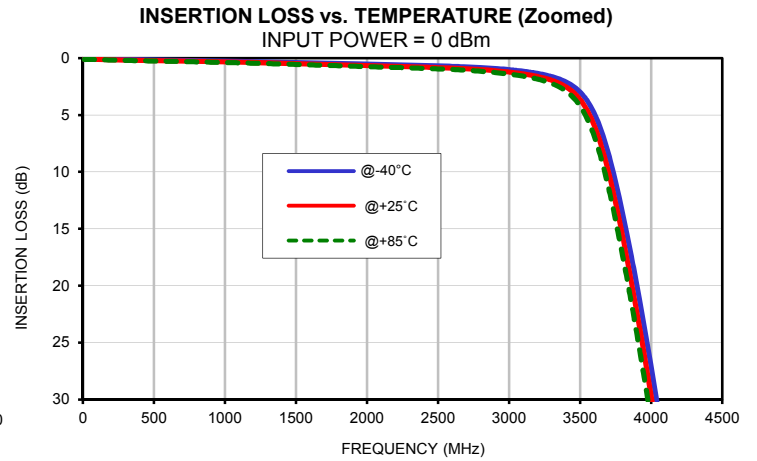
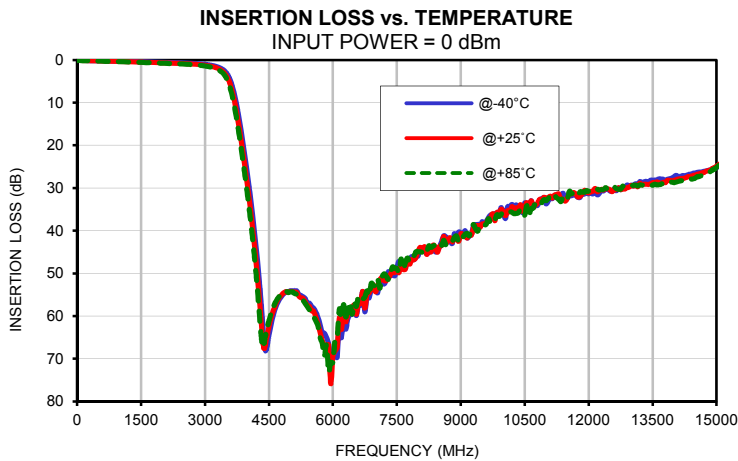

Outline Dimensions

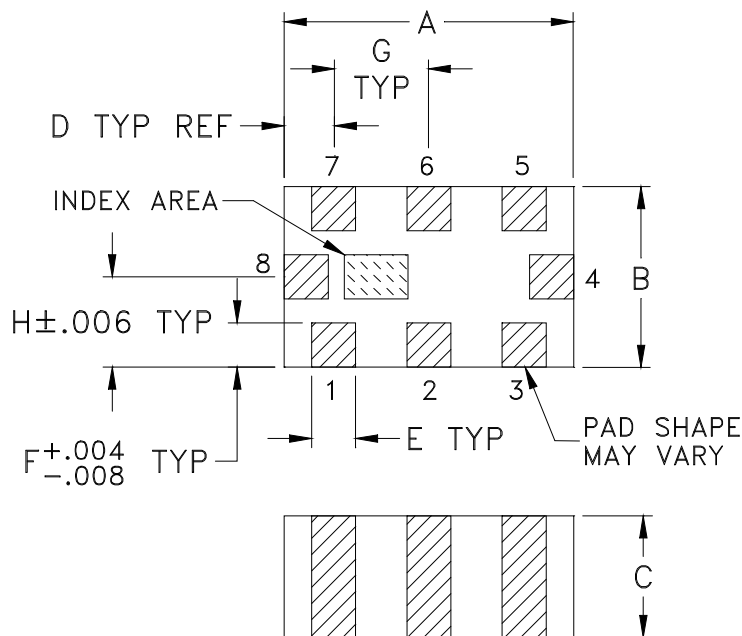

PCB Land Pattern

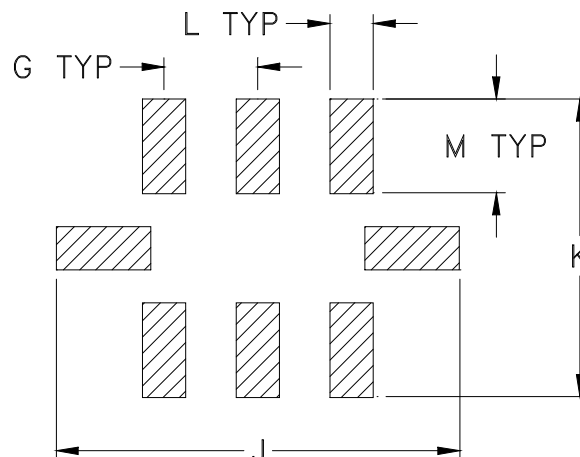

Suggested Layout,
Tolerance to be within $\pm.002$

CASE #	A	B	C	D	E	F	G	H	J	K	L
GE0805C-2	.079 (2.00)	.049 (1.25)	.037 (0.95)	.014 (0.35)	.012 (0.30)	.012 (0.30)	.026 (0.65)	.025 (0.63)	.134 (3.40)	.110 (2.80)	.014 (0.35)

CASE #	M	WT. GRAM
GE0805C-2	.039 (1.00)	.008

Dimensions are in inches (mm). Tolerances: 2Pl. $\pm .01$; 3 Pl. $\pm .005$

Notes:

- Open style, ceramic base.
- Termination finish: For RoHS Case Styles: Tin plate over Nickel plate. All models, (+) suffix.
For RoHS-5 Case Styles: Tin-Lead plate over Nickel plate. All models, no (+) suffix.
- Pad tolerance to be non-cumulative. Minimum spacing between each pad is .004 (0.1).



P.O. Box 350166, Brooklyn, New York 11235-0003 (718) 934-4500 Fax (718) 332-4661 For detailed performance specs & shopping online see Mini-Circuits web site



The Design Engineers Search Engine Provides ACTUAL Data Instantly From MINI-CIRCUITS At: www.minicircuits.com

RF/IF MICROWAVE COMPONENTS

Tape & Reel Packaging TR-F114

DEVICE ORIENTATION IN T&R



ILLUSTRATION 1

Applicable Case Styles	
GE0805C	JC0603C
GE0805C-1	JC0603C-4
GE0805C-1AP	JC0603C-6
GE0805C-7	
GE0805C-9	
GE0805C-10	
GE0805C-11	
GE0805C-12	

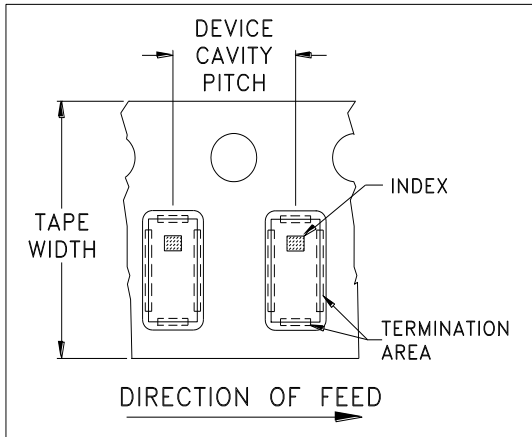

ILLUSTRATION 2

Applicable Case Styles	
GE0805C-2	JC0603C-1
GE0805C-3	JC0603C-2
GE0805C-4	JC0603C-3
GE0805C-5	JC0603C-5
GE0805C-6	JC0603C-7
GE0805C-8	
GE0805C-15	

Tape Width, mm	Device Cavity Pitch, mm	Reel Size, inches	Devices per Reel	
8	4	7	Small quantity standards (see note)	20
				50
				100
				200
				500
			Standard	4000

Note: Please Consult individual model data sheet to determine device per reel availability.

Mini-Circuits carrier tape materials provide protection from ESD (Electro-Static Discharge) during handling and transportation. Tapes are static dissipative and comply with industry standards EIA-481/EIA-541.

Go to: www.minicircuits.com/pages/pdfs/tape.pdf



INTERNET <http://www.minicircuits.com>

P.O. Box 350166, Brooklyn, New York 11235-0003 (718) 934-4500 Fax (718) 332-4661

Distribution Centers NORTH AMERICA 800-654-7949 • 417-335-5935 • Fax 417-335-5945 • EUROPE 44-1252-832600 • Fax 44-1252-837010

Mini-Circuits ISO 9001 & ISO 14001 Certified

THIRD ANGLE PROJECTION

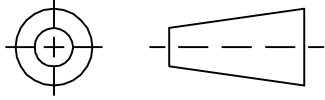

REVISIONS

REV	ECN No.	DESCRIPTION	DATE	DR	AUTH
OR	M148457	NEW RELEASE	10/14/14	GF	MY

SUGGESTED MOUNTING CONFIGURATION
FOR GE0805C-4 CASE STYLE, "08FL07" PIN CODE

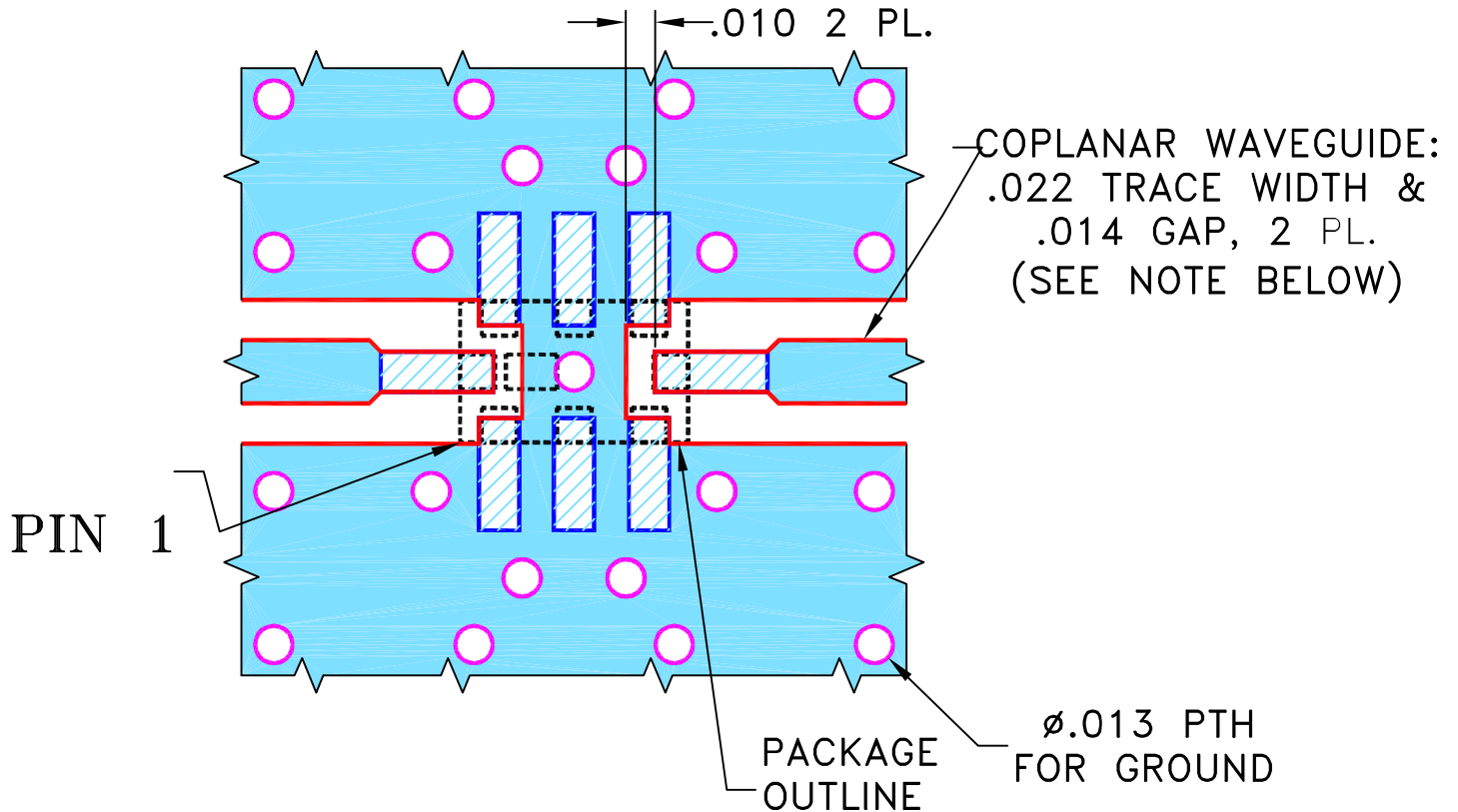

NOTES:

1. COPLANAR WAVEGUIDE IS SHOWN FOR ROGERS R04350B WITH DIELECTRIC THICKNESS .010" ± .001". COPPER: 1/2 OZ. EACH SIDE. FOR OTHER MATERIALS TRACE WIDTH AND GAP MAY NEED TO BE MODIFIED.
2. BOTTOM SIDE OF THE PCB IS CONTINUOUS GROUND PLANE.

 DENOTES PCB COPPER LAYOUT WITH SMOBC (SOLDER MASK OVER BARE COPPER).

 DENOTES COPPER LAND PATTERN FREE OF SOLDER MASK.

UNLESS OTHERWISE SPECIFIED	INITIALS	DATE
DIMENSIONS ARE IN INCHES	DRAWN GF	10/01/14
TOLERANCES ON:	CHECKED IL	10/14/14
2 PL DECIMALS ±	APPROVED MY	10/14/14
3 PL DECIMALS ± .005		
ANGLES ±		
FRACTIONS ±		

 **Mini-Circuits®** 13 Neptune Avenue
Brooklyn NY 11235

PL, 08FL07, GE0805C-4, TB-799+

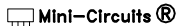
 Mini-Circuits®
THIS DOCUMENT AND ITS CONTENTS ARE THE PROPERTY OF MINI-CIRCUITS. EXCEPT FOR USE EXPRESSLY GRANTED, IN WRITING, TO ITS VENDORS, VENDEE AND THE UNITED STATES GOVERNMENT, MINI-CIRCUITS RESERVES ALL PROPRIETARY DESIGN, USE, MANUFACTURING AND REPRODUCTION RIGHTS THERETO. THESE CONTENTS SHALL NOT BE USED, DUPLICATED OR DISCLOSED TO ANY OUTSIDE PARTY, IN WHOLE OR IN PART, WITHOUT WRITTEN PERMISSION OF MINI-CIRCUITS.

SIZE	CODE IDENT	DRAWING NO:	REV:
A	15542	98-PL-429	OR
FILE:	98PL429	SCALE:	SHEET:
		15:1	1 OF 1

Evaluation Board and Circuit

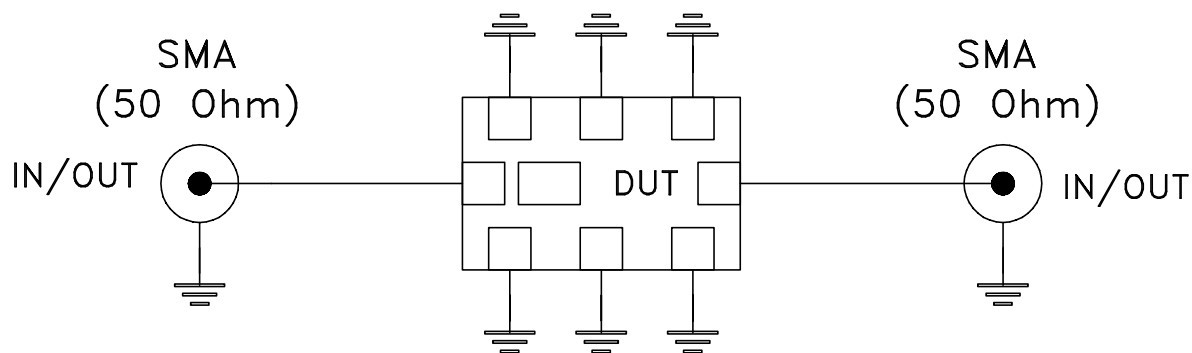
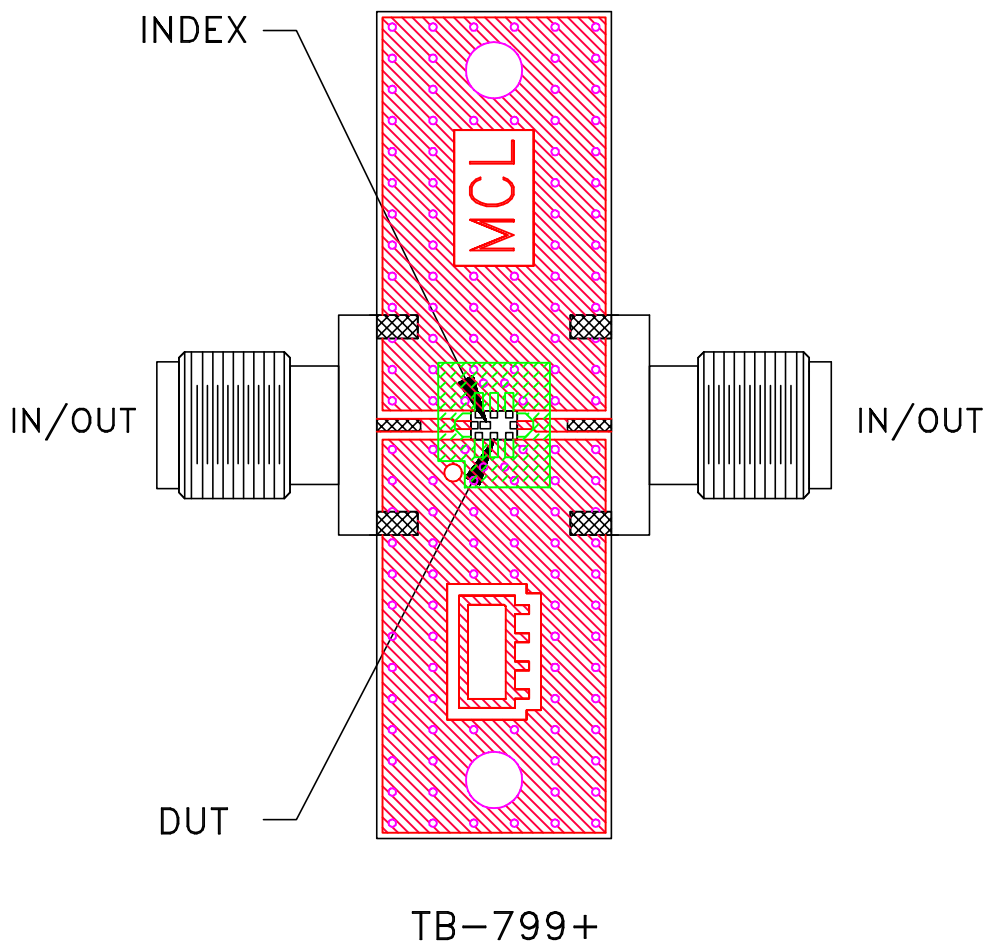

Notes:

1. 50 Ohm SMA Female connectors.
2. PCB Material: R04350 or equivalent,
Dielectric Constant=3.5, Thickness=.010 inch.

 **Mini-Circuits®**

All Mini-Circuits products are manufactured under exacting quality assurance and control standards, and are capable of meeting published specifications after being subjected to any or all of the following physical and environmental test.

Specification	Test/Inspection Condition	Reference/Spec
Operating Temperature	-55° to 100°C Ambient Environment	Individual Model Data Sheet
Storage Temperature	-55° to 100° C Ambient Environment	Individual Model Data Sheet
Humidity	90 to 95% RH, 240 hours, 50°C	MIL-STD-202, Method 103, Condition A, Except 50°C and end-point electrical test done within 12 hours
Solder Reflow Heat	Sn-Pb Eutetic Process: 225°C peak Pb-Free Process 245° - 250°C peak	J-STD-020, Table 4-1, 4-2 and 5-2, Figure 5-1
Solderability	10X Magnification	J-STD-002, Para 4.2.5, Test S, 95% Coverage
Vibration (High Frequency)	20g peak, 10-2000 Hz, 12 times in each of three perpendicular directions (total 36)	MIL-STD-202, Method 204, Condition D
Mechanical Shock	50g, 11 ms, 1/2-sine, 18 shocks: 3 each direction, each of 3 axes	MIL-STD-202, Method 213, Condition A