

Ceramic

Low Pass Filter

50Ω 4900 to 6100 MHz

LFCG-612+



Generic photo used for illustration purposes only
CASE STYLE: GE0805C-4

Features

- Low loss, 1 dB typ.
- Small size 0805 (2.0 x 1.25 mm)
- Temperature stable
- LTCC construction

Applications

- ISM band filtering
- Harmonic Rejection
- C band transmitters / receivers
- Lab use

+RoHS Compliant
The +Suffix identifies RoHS Compliance. See our web site for RoHS Compliance methodologies and qualifications



Available Tape and Reel
at no extra cost

Reel Size	Devices/Reel
7"	20, 50, 100, 200, 500, 1000, 4000

Electrical Specifications^{1,2} at 25°C

Parameter	F#	Frequency (MHz)	Min.	Typ.	Max.	Unit	
Pass Band	Insertion Loss	F0 - F1	4900 - 6100	—	1.0	1.2	dB
	Freq. cut-off	F2	7500	—	3.0	—	dB
	VSWR	F0- F1	4900 - 6100	—	1.7	—	:1
Stop Band	Rejection Loss	F3	8200	—	20	—	dB
		F4 - F5	9800 - 12200	33	40	—	dB
		F6	14700 - 18300	25	33	—	dB

¹ In Application where DC voltage is present at either input or output port, coupling capacitors are required.

² Measured on Mini-Circuits Characterization Test Board TB-799+

Maximum Ratings

Operating Temperature	-55°C to +100°C
Storage Temperature	-55°C to +100°C
RF Power Input*	1W at 25°C

*Passband rating, derate linearly to 0.5W at 100°C ambient
Permanent damage may occur if any of these limits are exceeded.

Typical Performance Data at 25°C

Frequency (MHz)	Insertion Loss (dB)	VSWR (:1)
10	0.16	1.01
200	0.16	1.26
600	0.63	1.96
1000	1.39	2.90
3000	3.72	6.22
4900	0.78	1.52
6100	0.78	1.24
7500	2.55	1.64
8200	22.02	22.66
9800	43.00	53.85
12200	41.19	74.67
14700	47.48	32.13
16000	52.06	36.96
17000	56.18	124.20
18300	62.88	30.30
20000	44.34	105.03

Specification Definition

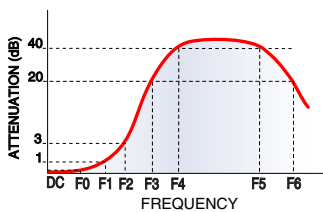

Functional Schematic

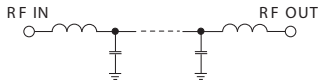

Top View

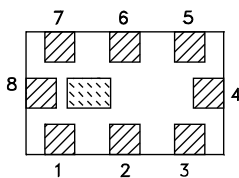

Pad Connections

Input	8
Output	4
Ground	1,2,3,5,6,7

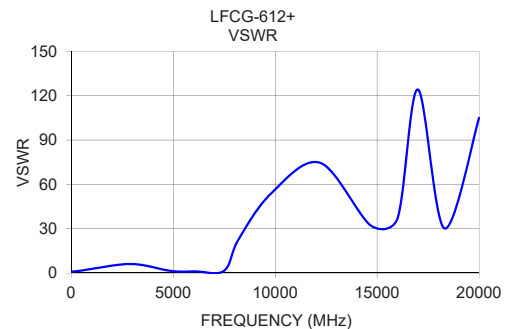
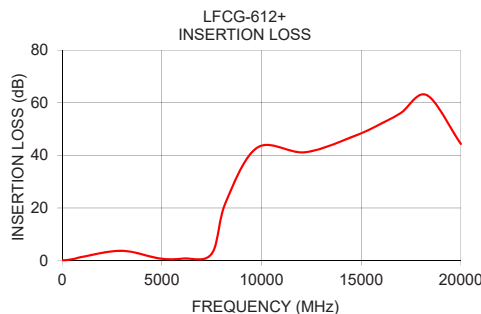

Low Pass Filter

LFCG-612+

Outline Drawing

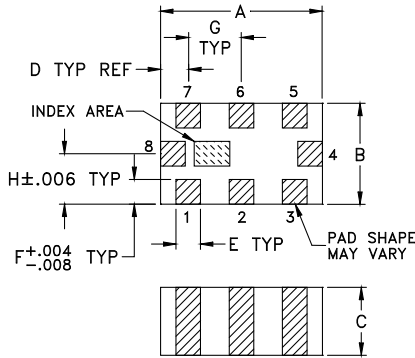

Pad Connections

Input	8
Output	4
Ground	1,2,3,5,6,7

Outline Dimensions (inch/mm)

A	B	C	D	E	F	G
.079	.049	.027	.014	.012	.012	.026
2.01	1.24	0.69	0.36	0.30	0.30	0.66
H	J	K	L	M		wt
.025	.134	.110	.014	.039		grams
0.64	3.40	2.80	0.36	0.99		.008

PCB Land Pattern

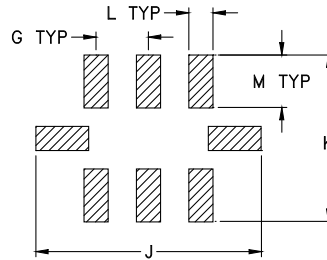

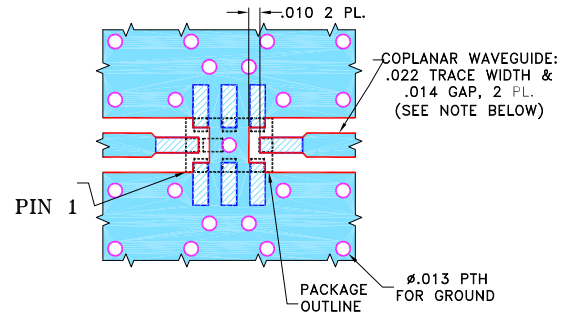

Suggested Layout,
Tolerance to be within ±.002

Demo Board MCL P/N: TB-799+ Suggested PCB Layout (PL-429)



NOTES:

1. COPLANAR WAVEGUIDE IS SHOWN FOR ROGERS R04350B WITH DIELECTRIC THICKNESS .010" ± .001". COPPER: 1/2 OZ. EACH SIDE. FOR OTHER MATERIALS TRACE WIDTH AND GAP MAY NEED TO BE MODIFIED.
2. BOTTOM SIDE OF THE PCB IS CONTINUOUS GROUND PLANE.
 -  DENOTES PCB COPPER LAYOUT WITH SMOBC (SOLDER MASK OVER BARE COPPER).
 -  DENOTES COPPER LAND PATTERN FREE OF SOLDER MASK.

Additional Notes

- A. Performance and quality attributes and conditions not expressly stated in this specification document are intended to be excluded and do not form a part of this specification document.
- B. Electrical specifications and performance data contained in this specification document are based on Mini-Circuit's applicable established test performance criteria and measurement instructions.
- C. The parts covered by this specification document are subject to Mini-Circuits standard limited warranty and terms and conditions (collectively, "Standard Terms"); Purchasers of this part are entitled to the rights and benefits contained therein. For a full statement of the Standard Terms and the exclusive rights and remedies thereunder, please visit Mini-Circuits' website at www.minicircuits.com/MCLStore/terms.jsp



Ceramic Low Pass Filter

LF CG-612+

Typical Performance Data

FREQUENCY (MHz)	INSERTION LOSS (dB)	VSWR (:1)
10.0	0.16	1.01
50.0	0.05	1.06
100.0	0.11	1.12
200.0	0.16	1.26
400.0	0.35	1.58
600.0	0.63	1.96
800.0	0.99	2.40
1000.0	1.39	2.90
1200.0	1.81	3.44
1400.0	2.22	3.98
1600.0	2.60	4.51
1800.0	2.94	5.03
2000.0	3.23	5.49
3000.0	3.72	6.22
4000.0	2.42	3.80
4900.0	0.78	1.52
5000.0	0.69	1.36
6000.0	0.77	1.28
6100.0	0.78	1.24
7000.0	1.54	1.70
7500.0	2.55	1.64
8200.0	22.02	22.66
8500.0	29.94	30.60
9000.0	39.03	42.82
9500.0	42.50	55.06
9800.0	43.00	53.85
10000.0	43.07	51.70
10500.0	42.53	43.36
11000.0	41.91	41.88
11500.0	41.46	44.13
12000.0	41.25	56.62
12200.0	41.19	74.67
12500.0	41.27	116.04
14000.0	44.62	77.74
14500.0	46.74	38.31
14700.0	47.48	32.13
15000.0	48.64	28.18
15500.0	50.37	28.12
16000.0	52.06	36.96
16500.0	53.51	64.13
17000.0	56.18	124.20
17500.0	59.49	72.72
18000.0	61.33	35.62
18300.0	62.88	30.30
18500.0	64.42	29.49
19000.0	60.41	35.15
19500.0	54.88	78.90
20000.0	44.34	105.03



P.O. Box 350166, Brooklyn, New York 11235-0003 (718) 934-4500 • Fax (718) 332-4661 For detailed performance specs & shopping online see Mini-Circuits web site



The Design Engineers Search Engine Provides ACTUAL Data Instantly From MINI-CIRCUITS At: www.minicircuits.com

IF/RF MICROWAVE COMPONENTS

REV. OR
LF CG-612+
11/3/2014
Page 1 of 1

Ceramic Low Pass Filter

LFCG-612+

Typical Performance Curves

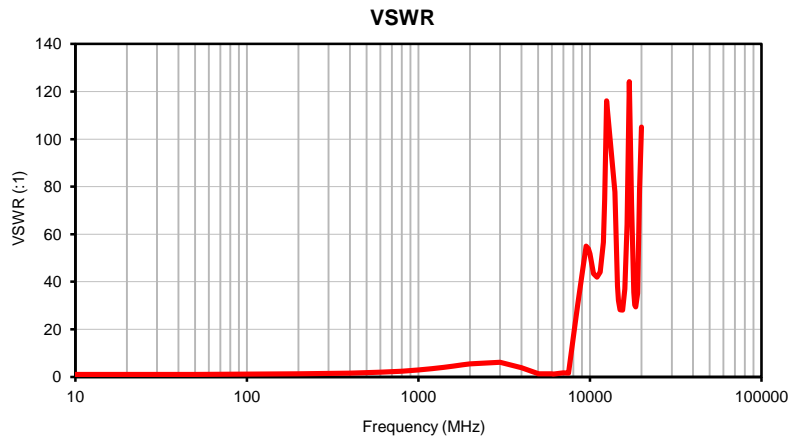
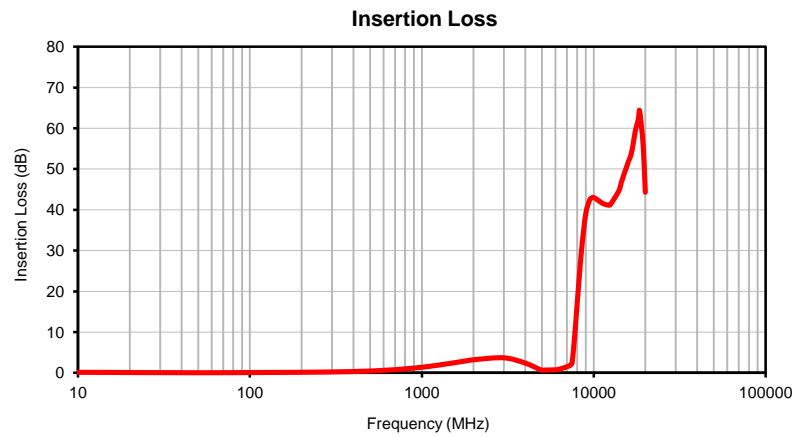

Outline Dimensions

PCB Land Pattern

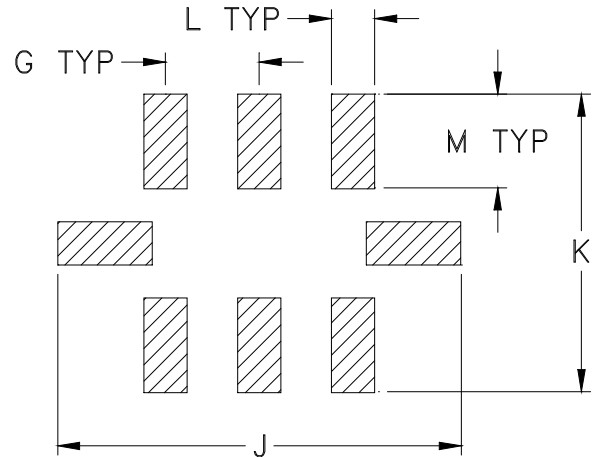
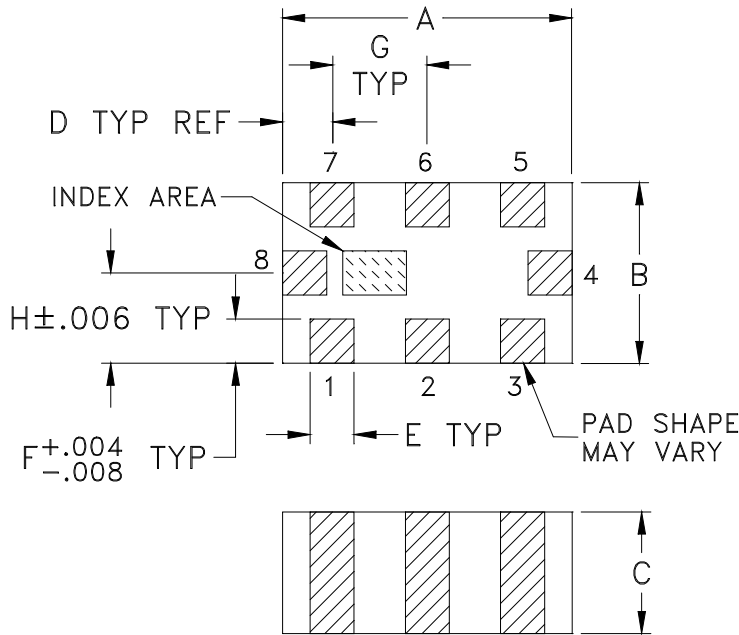

Suggested Layout,
Tolerance to be within ± 0.002

CASE #	A	B	C	D	E	F	G	H	J	K	L
GE0805C-4	.079 (2.00)	.049 (1.25)	.027 (0.70)	.014 (0.35)	.012 (0.30)	.012 (0.30)	.026 (0.65)	.025 (0.63)	.134 (3.40)	.110 (2.80)	.014 (0.35)

CASE #	M	WT. GRAM
GE0805C-4	.039 (1.00)	.008

Dimensions are in inches (mm). Tolerances: 2Pl. $\pm .01$; 3 Pl. $\pm .005$

Notes:

1. Open style, ceramic base.
2. Termination finish: For RoHS Case Styles: Tin plate over Nickel plate. All models, (+) suffix.
For RoHS-5 Case Styles: Tin-Lead plate over Nickel plate. All models, no (+) suffix.
3. Pad tolerance to be non-cumulative. Minimum spacing between each pad is .004 (0.1).

Tape & Reel Packaging TR-F114

DEVICE ORIENTATION IN T&R



ILLUSTRATION 1

Applicable Case Styles	
GE0805C	JC0603C
GE0805C-1	JC0603C-4
GE0805C-1AP	JC0603C-6
GE0805C-7	
GE0805C-9	
GE0805C-10	
GE0805C-11	
GE0805C-12	

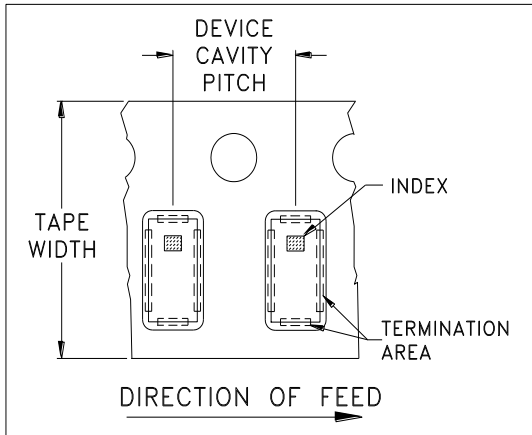

ILLUSTRATION 2

Applicable Case Styles	
GE0805C-2	JC0603C-1
GE0805C-3	JC0603C-2
GE0805C-4	JC0603C-3
GE0805C-5	JC0603C-5
GE0805C-6	JC0603C-7
GE0805C-8	
GE0805C-15	

Tape Width, mm	Device Cavity Pitch, mm	Reel Size, inches	Devices per Reel	
8	4	7	Small quantity standards (see note)	20
				50
				100
				200
				500
				1000
			Standard	4000

Note: Please Consult individual model data sheet to determine device per reel availability.

Mini-Circuits carrier tape materials provide protection from ESD (Electro-Static Discharge) during handling and transportation. Tapes are static dissipative and comply with industry standards EIA-481/EIA-541.

Go to: www.minicircuits.com/pages/pdfs/tape.pdf



INTERNET <http://www.minicircuits.com>

P.O. Box 350166, Brooklyn, New York 11235-0003 (718) 934-4500 Fax (718) 332-4661

Distribution Centers NORTH AMERICA 800-654-7949 • 417-335-5935 • Fax 417-335-5945 • EUROPE 44-1252-832600 • Fax 44-1252-837010

Mini-Circuits ISO 9001 & ISO 14001 Certified

THIRD ANGLE PROJECTION

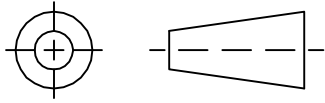

REVISIONS

REV	ECN No.	DESCRIPTION	DATE	DR	AUTH
OR	M148457	NEW RELEASE	10/14/14	GF	MY

SUGGESTED MOUNTING CONFIGURATION
FOR GE0805C-4 CASE STYLE, "08FL07" PIN CODE

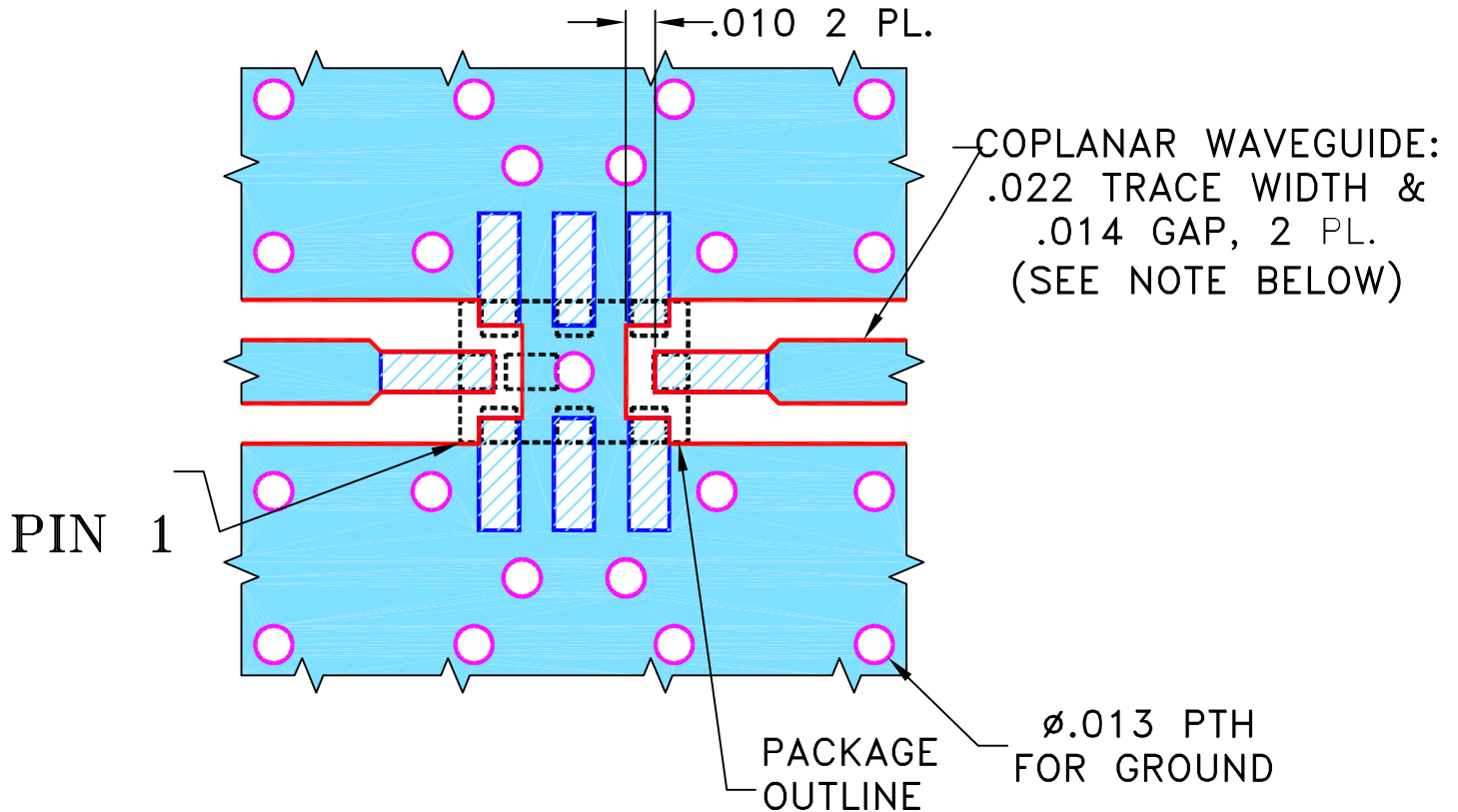

NOTES:

1. COPLANAR WAVEGUIDE IS SHOWN FOR ROGERS R04350B WITH DIELECTRIC THICKNESS .010" ± .001". COPPER: 1/2 OZ. EACH SIDE. FOR OTHER MATERIALS TRACE WIDTH AND GAP MAY NEED TO BE MODIFIED.
2. BOTTOM SIDE OF THE PCB IS CONTINUOUS GROUND PLANE.

 DENOTES PCB COPPER LAYOUT WITH SMOBC (SOLDER MASK OVER BARE COPPER).

 DENOTES COPPER LAND PATTERN FREE OF SOLDER MASK.

UNLESS OTHERWISE SPECIFIED	INITIALS	DATE
DIMENSIONS ARE IN INCHES	DRAWN GF	10/01/14
TOLERANCES ON:	CHECKED IL	10/14/14
2 PL DECIMALS ±	APPROVED MY	10/14/14
3 PL DECIMALS ± .005		
ANGLES ±		
FRACTIONS ±		

 **Mini-Circuits[®]** 13 Neptune Avenue
Brooklyn NY 11235

PL, 08FL07, GE0805C-4, TB-799+

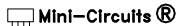
 Mini-Circuits[®]
THIS DOCUMENT AND ITS CONTENTS ARE THE PROPERTY OF MINI-CIRCUITS. EXCEPT FOR USE EXPRESSLY GRANTED, IN WRITING, TO ITS VENDORS, VENDEE AND THE UNITED STATES GOVERNMENT, MINI-CIRCUITS RESERVES ALL PROPRIETARY DESIGN, USE, MANUFACTURING AND REPRODUCTION RIGHTS THERETO. THESE CONTENTS SHALL NOT BE USED, DUPLICATED OR DISCLOSED TO ANY OUTSIDE PARTY, IN WHOLE OR IN PART, WITHOUT WRITTEN PERMISSION OF MINI-CIRCUITS.

SIZE	CODE IDENT	DRAWING NO:	REV:
A	15542	98-PL-429	OR
FILE:	98PL429	SCALE:	SHEET:
		15:1	1 OF 1

Evaluation Board and Circuit

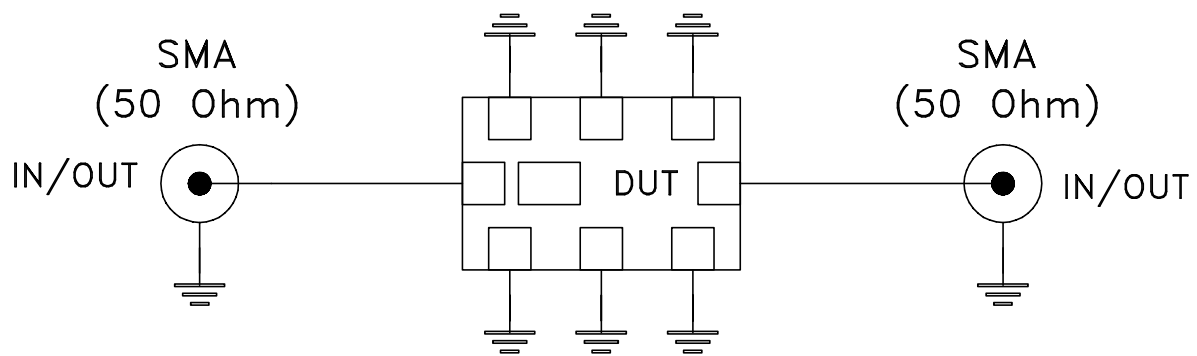
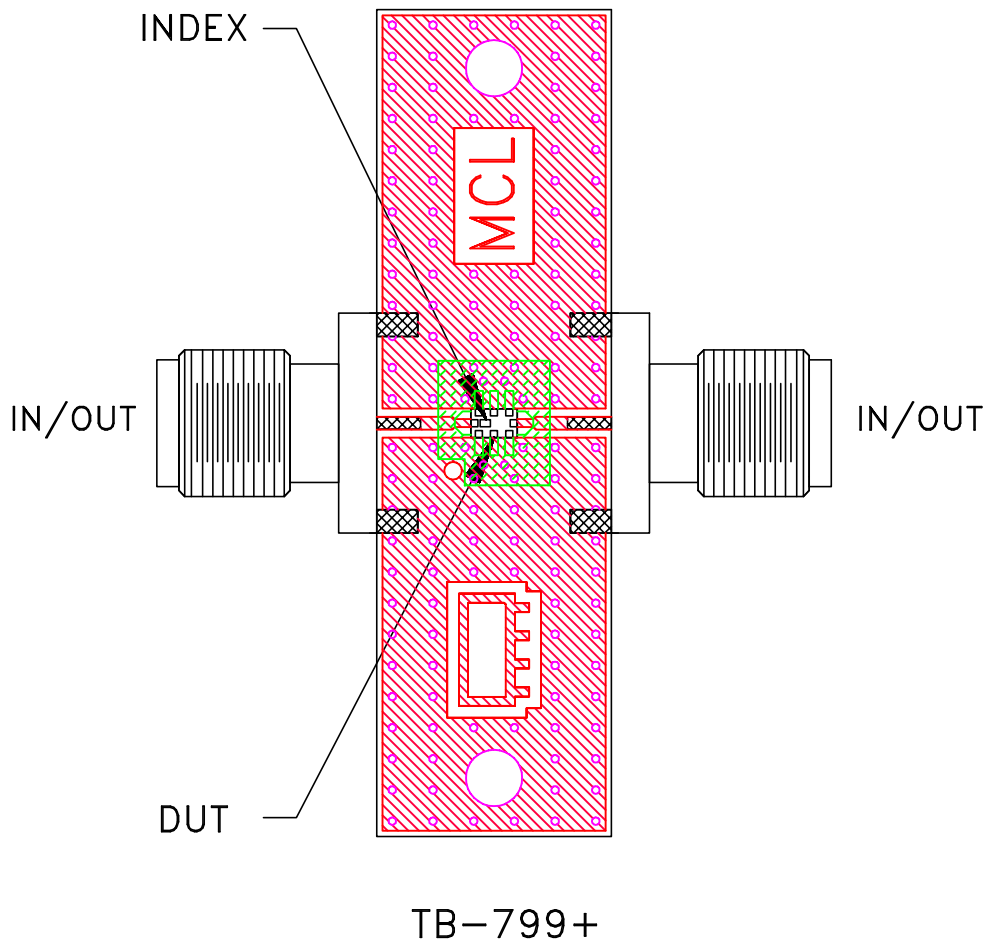

Schematic Diagram

Notes:

1. 50 Ohm SMA Female connectors.
2. PCB Material: R04350 or equivalent, Dielectric Constant=3.5, Thickness=.010 inch.

 **Mini-Circuits®**

All Mini-Circuits products are manufactured under exacting quality assurance and control standards, and are capable of meeting published specifications after being subjected to any or all of the following physical and environmental test.

Specification	Test/Inspection Condition	Reference/Spec
Operating Temperature	-55° to 100°C Ambient Environment	Individual Model Data Sheet
Storage Temperature	-55° to 100° C Ambient Environment	Individual Model Data Sheet
Humidity	90 to 95% RH, 240 hours, 50°C	MIL-STD-202, Method 103, Condition A, Except 50°C and end-point electrical test done within 12 hours
Solder Reflow Heat	Sn-Pb Eutetic Process: 225°C peak Pb-Free Process 245° - 250°C peak	J-STD-020, Table 4-1, 4-2 and 5-2, Figure 5-1
Solderability	10X Magnification	J-STD-002, Para 4.2.5, Test S, 95% Coverage
Vibration (High Frequency)	20g peak, 10-2000 Hz, 12 times in each of three perpendicular directions (total 36)	MIL-STD-202, Method 204, Condition D
Mechanical Shock	50g, 11 ms, 1/2-sine, 18 shocks: 3 each direction, each of 3 axes	MIL-STD-202, Method 213, Condition A