



CERAMIC

Low Pass Filter

LFCN-2250+

50Ω DC¹ to 2200 MHz

FEATURES

- Excellent power handling, 10W
- Small size
- 7 sections
- Temperature stable
- LTCC construction
- Protected by U.S Patent 6,943,646

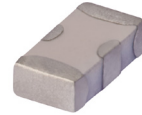

Generic photo used for illustration purposes only

CASE STYLE: FV1206

APPLICATIONS

- Harmonic rejection
- VHF/UHF transmitters/receivers
- Lab use

+RoHS Compliant
 The +Suffix identifies RoHS Compliance.
 See our website for methodologies and qualifications

ELECTRICAL SPECIFICATIONS^{1,2} AT +25°C

Parameter	F#	Frequency (MHz)	Min.	Typ.	Max.	Units	
Passband	Insertion Loss	DC-F1	DC-2200	—	—	1.2	dB
	Freq. Cut-Off	F2*	2575	—	3.0	—	dB
	VSWR	DC-F1	DC-2200	—	1.2	—	:1
Stop Band	Rejection Loss	F3	2900	20	—	—	dB
		F4-F5	3000-5000	—	30	—	
	VSWR	F6	7200	—	20	—	:1
		F3-F6	2900-7200	—	20	—	

1. In Application where DC voltage is present at either input or output ports, coupling capacitors are required. Alternatively, if DC pass IN-OUT is required, Mini-Circuits' "D" suffix version of this model will support DC IN-OUT, and provide >100 MOhm isolation to ground.

2. Measured on Mini-Circuits Characterization Test Board TB-270.

* Typically, a ±5% frequency deviation from the stated value may occur on a unit-to-unit basis.

ABSOLUTE MAXIMUM RATINGS

Parameter	Ratings
Operating temperature	-55°C to 100°C
Storage temperature	-55°C to 100°C
RF Power Input ³	10 W max. at 25°C

3. Passband rating, derate linearly to 3.5W at 100°C ambient. Permanent damage may occur if any of these limits are exceeded.

TYPICAL FREQUENCY RESPONSE



FUNCTIONAL SCHEMATIC

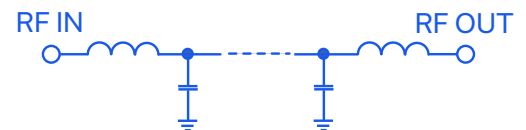

REV. R
 ECO-023490
 LFCN-2250+
 MCL NY
 241114





CERAMIC

Low Pass Filter

LFCN-2250+

PIN CONNECTIONS

RF IN	1
RF OUT	3
GROUND	2,4

PRODUCT MARKING: MV

DEMO BOARD MCL P/N: TB-270
SUGGESTED PCB LAYOUT (PL-137)



- NOTES:**
1. COPLANAR WAVEGUIDE PARAMETERS ARE SHOWN FOR ROGERS RO4350B WITH THICKNESS .020" ± .0015". COPPER: 1/2 OZ. EACH SIDE. FOR OTHER MATERIALS TRACE WIDTH & GAP MAY NEED TO BE MODIFIED.
 2. BOTTOM SIDE OF THE PCB IS CONTINUOUS GROUND PLANE.

- DENOTES PCB COPPER LAYOUT WITH SMOBC (SOLDER MASK OVER BARE COPPER)
- DENOTES COPPER LAND PATTERN FREE OF SOLDER MASK

OUTLINE DRAWING



PCB Land Pattern



Suggested Layout,
Tolerance to be within ±.002

OUTLINE DIMENSIONS (Inches mm)

A	B	C	D	E	F	G
.126	.063	.037	.020	.032	.009	.169
3.20	1.60	0.94	0.51	0.81	0.23	4.29

H	J	K	L	M	N	P	wt
.087	.024	.122	.024	.087	.012	.071	grams
2.21	0.61	3.10	0.61	2.21	0.30	1.80	.020



CERAMIC

Low Pass Filter

LFCN-2250+

TYPICAL PERFORMANCE DATA AT +25°C

Frequency (MHz)	Insertion Loss (dB)	VSWR (:1)
50.00	0.06	1.01
500.00	0.11	1.02
1000.00	0.15	1.05
1500.00	0.33	1.07
2000.00	0.51	1.06
2250.00	0.82	1.20
2575.00	2.84	2.10
2850.00	24.55	7.08
3800.00	48.40	32.18
4250.00	37.39	34.07
5000.00	33.16	36.97
6500.00	37.38	30.49
7200.00	30.64	39.49
8000.00	7.60	9.69
9000.00	14.79	30.49

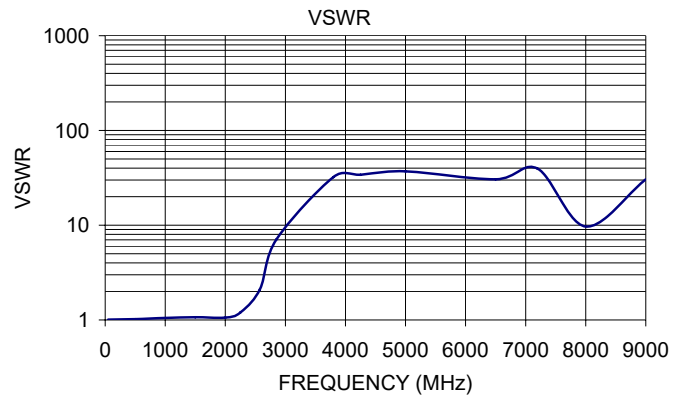

NOTES

- A. Performance and quality attributes and conditions not expressly stated in this specification document are intended to be excluded and do not form a part of this specification document.
- B. Electrical specifications and performance data contained in this specification document are based on Mini-Circuit's applicable established test performance criteria and measurement instructions.
- C. The parts covered by this specification document are subject to Mini-Circuits standard limited warranty and terms and conditions (collectively, "Standard Terms"); Purchasers of this part are entitled to the rights and benefits contained therein. For a full statement of the standard. Terms and the exclusive rights and remedies thereunder, please visit Mini-Circuits' website at www.minicircuits.com/MCLStore/terms.jsp



Ceramic Low Pass Filter

LFCN-2250+

Typical Performance Data

FREQ. (MHz)	INSERTION LOSS (dB)			INPUT RETURN LOSS (dB)			OUTPUT RETURNLOSS (dB)		
	@ -55° C	@ +25° C	@ +100° C	@ -55° C	@ +25° C	@ +100° C	@ -55° C	@ +25° C	@ +100° C
50	0.03	0.04	0.05	36.05	34.57	33.45	35.64	34.22	33.21
100	0.04	0.05	0.06	38.34	36.62	35.26	38.59	36.73	35.20
200	0.05	0.07	0.09	34.90	35.94	37.12	34.82	36.00	36.73
400	0.07	0.11	0.14	33.54	34.69	37.38	32.96	33.83	37.20
800	0.11	0.18	0.23	33.02	35.36	41.46	30.35	31.23	33.23
1000	0.14	0.20	0.28	34.12	36.01	38.17	30.25	30.23	29.93
1500	0.23	0.32	0.42	29.30	29.32	27.64	27.59	26.80	24.58
2000	0.41	0.54	0.70	25.06	25.42	25.58	23.66	23.57	23.24
2180	0.59	0.76	0.96	21.34	20.83	20.75	19.97	19.39	19.07
2250	0.70	0.90	1.12	19.17	18.76	18.81	17.89	17.43	17.22
2270	0.76	0.96	1.19	18.43	18.11	18.16	17.19	16.80	16.60
2520	2.15	2.63	3.24	12.59	13.02	13.49	9.48	9.10	8.69
2575	3.35	4.11	5.10	10.24	10.22	10.00	6.89	6.45	5.97
2655	7.82	9.31	11.12	4.99	4.83	4.70	3.04	2.93	2.90
2700	12.28	14.10	16.24	3.16	3.19	3.25	1.89	1.97	2.11
2740	17.07	19.08	21.41	2.26	2.38	2.52	1.40	1.55	1.76
2770	21.13	23.14	25.51	1.86	1.99	2.17	1.22	1.37	1.61
2800	25.31	27.35	29.75	1.56	1.75	1.93	1.08	1.26	1.50
2820	27.98	30.11	32.45	1.41	1.62	1.79	1.00	1.20	1.43
2850	31.87	34.29	35.78	1.24	1.44	1.64	0.93	1.12	1.36
2880	34.91	36.91	38.23	1.12	1.30	1.53	0.87	1.06	1.30
2920	38.09	38.08	38.42	1.00	1.16	1.38	0.81	0.99	1.22
2950	37.88	37.63	37.71	0.90	1.10	1.32	0.77	0.96	1.19
3230	33.23	33.55	33.78	0.55	0.73	0.95	0.57	0.74	0.92
3530	39.56	40.55	41.05	0.41	0.59	0.83	0.45	0.61	0.73
3700	48.02	45.44	46.12	0.38	0.56	0.81	0.41	0.55	0.68
4200	35.82	35.77	35.92	0.30	0.48	0.72	0.34	0.48	0.59
4700	34.31	34.50	34.99	0.30	0.47	0.63	0.31	0.46	0.65
5000	35.62	34.00	35.20	0.30	0.48	0.63	0.30	0.51	0.66
5500	31.40	33.23	34.82	0.36	0.52	0.72	0.40	0.49	0.69
6000	28.71	33.65	32.66	0.47	0.57	0.96	0.46	0.49	0.80
6650	28.03	30.78	28.29	0.49	0.66	1.14	0.41	0.54	0.85
7200	22.55	22.60	21.08	0.65	0.86	1.29	0.51	0.75	1.09
7330	19.64	19.37	18.02	0.71	0.93	1.39	0.66	0.86	1.26
7500	14.50	13.76	12.03	1.11	1.29	1.97	1.20	1.57	2.52
7630	8.86	7.62	6.85	2.16	2.94	3.92	3.46	5.78	11.15
7700	5.86	5.81	6.73	3.78	4.26	3.82	10.26	15.26	9.35
7760	5.58	6.74	8.38	3.77	3.15	2.70	10.21	6.13	4.32
8000	11.66	12.62	14.05	1.20	1.18	1.60	1.20	1.16	1.34
9000	17.18	17.43	17.49	0.79	1.03	1.56	0.43	0.56	0.77

REV. X1
LFCN-2250+
070926
Page 1 of 1



IF/RF MICROWAVE COMPONENTS • ISO 9001 ISO 14001 AS 9100 CERTIFIED • RoHS compliant
P.O. Box 350166, Brooklyn, New York 11235-0003 (718) 934-4500 Fax (718) 332-4661



The Design Engineers Search Engine finds the model you need, Instantly • For detailed performance specs & shopping online see



Ceramic Low Pass Filter

Typical Performance Curves

LFCN-2250+

INSERTION LOSS vs. TEMPERATURE

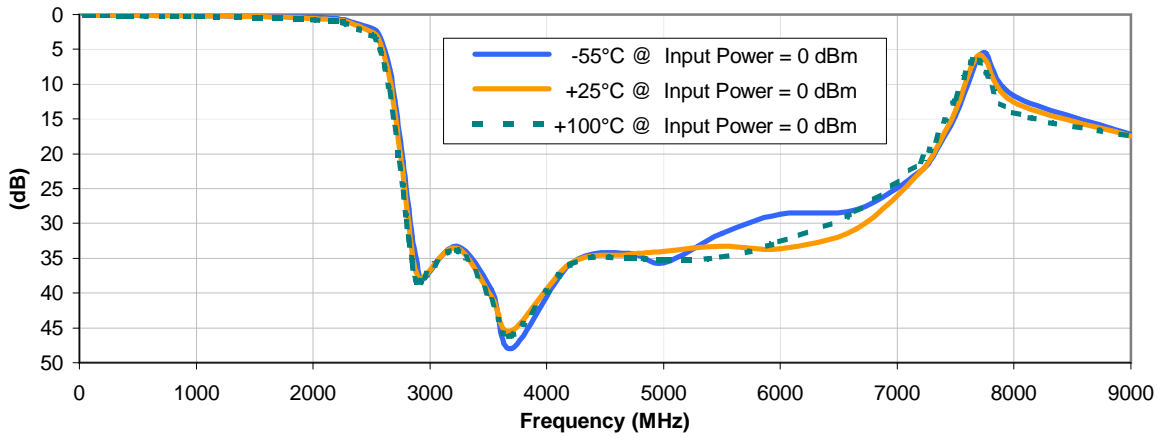

INPUT RETURN LOSS vs. TEMPERATURE

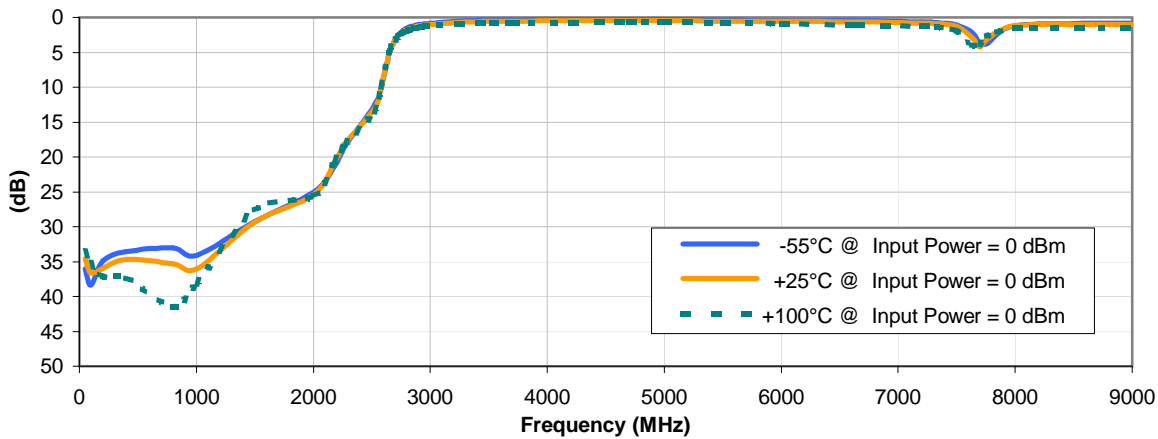

OUTPUT RETURN LOSS vs. TEMPERATURE

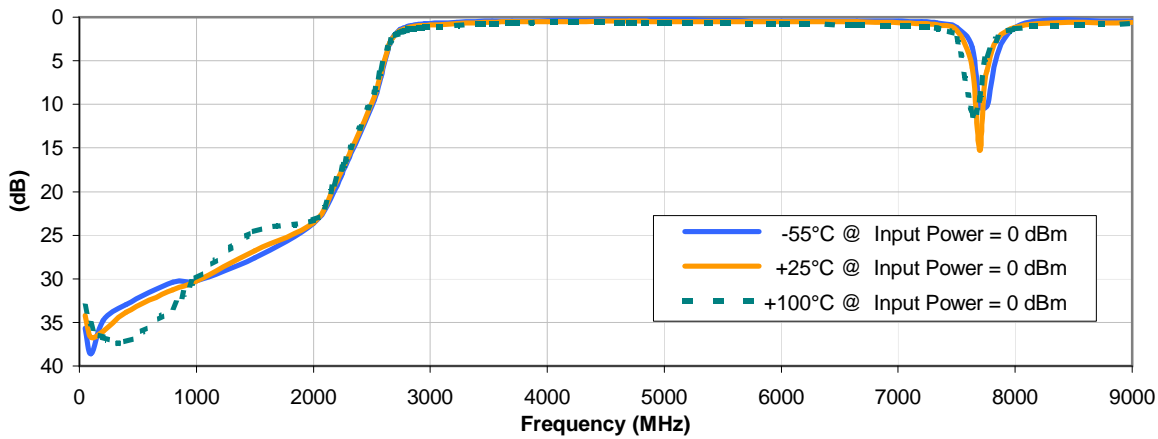

REV. X1
LFCN-2250+
070926
Page 1 of 1



IF/RF MICROWAVE COMPONENTS • ISO 9001 ISO 14001 AS 9100 CERTIFIED RoHS compliant
P.O. Box 350166, Brooklyn, New York 11235-0003 (718) 934-4500 Fax (718) 332-4661



The Design Engineers Search Engine finds the model you need, Instantly • For detailed performance specs & shopping online see



Outline Dimensions

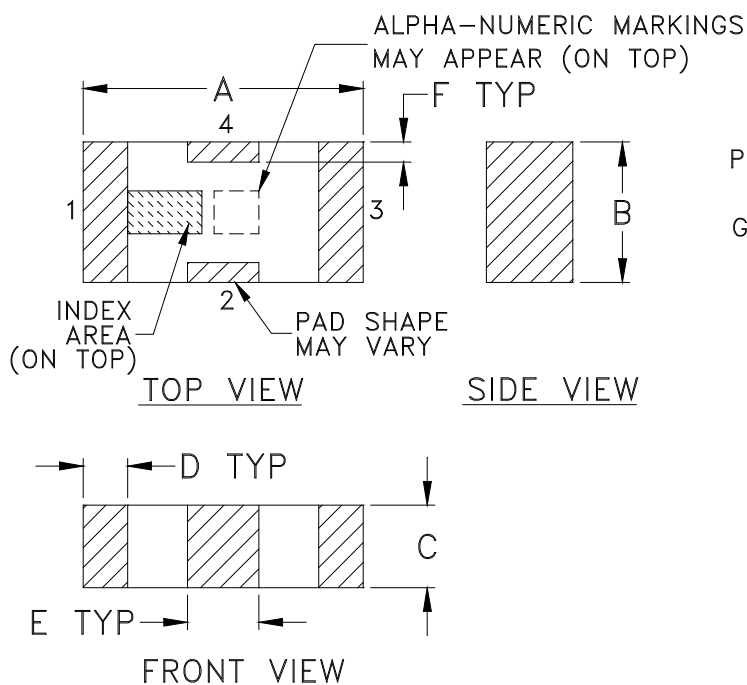

PCB Land Pattern



Suggested Layout,
Tolerance to be within $\pm .002$

CASE #	A	B	C	D	E	F	G	H	J	K	L	M	N	P	WT. GRAM
FV1206	.126 (3.20)	.063 (1.60)	.037 (0.94)	.020 (0.51)	.032 (0.81)	.009 (0.23)	.169 (4.29)	.087 (2.21)	.024 (0.61)	.122 (3.10)	.024 (0.61)	.087 (2.21)	.012 (0.30)	.071 (1.80)	.020

Dimensions are in inches (mm). Tolerances: 2 Pl. $\pm .01$; 3 Pl. $\pm .005$

Notes:

- Open style, ceramic base.
- Termination finish: **as shown below or indicated on Data Sheet.**
For RoHS Case Styles: Tin plate over Nickel plate. All models, (+) suffix.
For RoHS-5 Case Styles: Tin-Lead plate. All models, no (+) suffix.



P.O. Box 350166, Brooklyn, New York 11235-0003 (718) 934-4500 Fax (718) 332-4661 For detailed performance specs & shopping online see Mini-Circuits web site



The Design Engineers Search Engine Provides ACTUAL Data Instantly From MINI-CIRCUITS At: www.minicircuits.com

RF/IF MICROWAVE COMPONENTS

Tape & Reel Packaging TR-F71



ILLUSTRATION 1

Tape Width, mm	Device Cavity Pitch, mm	Reel Size, inches	Devices per Reel	
8	4	7	Small quantity standards (see note)	20
				50
				100
				200
				500
				1000
			Standard	3000

Note: Please Consult individual model data sheet to determine device per reel availability.

Mini-Circuits carrier tape materials provide protection from ESD (Electro-Static Discharge) during handling and transportation. Tapes are static dissipative and comply with industry standards EIA-481/EIA-541.

Go to: www.minicircuits.com/pages/pdfs/tape.pdf



P.O. Box 350166, Brooklyn, New York 11235-0003 (718) 934-4500 Fax (718) 332-4661 For detailed performance specs & shopping online see Mini-Circuits web site



The Design Engineers Search Engine Provides ACTUAL Data Instantly From MINI-CIRCUITS At: www.minicircuits.com

RF/IF MICROWAVE COMPONENTS

THIRD ANGLE PROJECTION



REVISIONS

REV	ECN No.	DESCRIPTION	DATE	DR	AUTH
OR	M88634	NEW RELEASE	08/28/03	GF	ABD
A	M102713	ADDED "...WITH SMOBC"	01/17/06	MMG	IL

SUGGESTED MOUNTING CONFIGURATION
FOR FV1206 CASE STYLE, "nx" PIN CONNECTION



- NOTES:
- COPLANAR WAVEGUIDE PARAMETERS ARE SHOWN FOR ROGERS R04350B WITH THICKNESS .020" ± .0015".
 COPPER: 1/2 OZ. EACH SIDE.
 FOR OTHER MATERIALS TRACE WIDTH & GAP MAY NEED TO BE MODIFIED.

2. BOTTOM SIDE OF THE PCB IS CONTINUOUS GROUND PLANE.



DENOTES PCB COPPER LAYOUT WITH SMOBC
 (SOLDER MASK OVER BARE COPPER)



DENOTES COPPER LAND PATTERN FREE OF SOLDER MASK

UNLESS OTHERWISE SPECIFIED	INITIALS	DATE
DIMENSIONS ARE IN INCHES TOLERANCES ON: 2 PL DECIMALS ± 3 PL DECIMALS ± .005 ANGLES ± FRACTIONS ±	DRAWN	GF 08/27/03
	CHECKED	AV 08/28/03
	APPROVED	ABD 08/28/03

 **Mini-Circuits®** 13 Neptune Avenue
 Brooklyn NY 11235

PL, nx, FV1206, LFCN/HFCN, TB-270

SIZE A	CODE IDENT 15542	DRAWING NO: 98-PL-137	REV: A
FILE: 98PL137	SCALE: 10:1	SHEET: 1 OF 1	

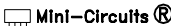
 Mini-Circuits®
 THIS DOCUMENT AND ITS CONTENTS ARE THE PROPERTY OF MINI-CIRCUITS.
 EXCEPT FOR USE EXPRESSLY GRANTED, IN WRITING, TO ITS VENDORS, VENDEE
 AND THE UNITED STATES GOVERNMENT, MINI-CIRCUITS RESERVES ALL PROPRIETARY
 DESIGN, USE, MANUFACTURING AND REPRODUCTION RIGHTS THERETO.
 THESE CONTENTS SHALL NOT BE USED, DUPLICATED OR DISCLOSED TO ANY OUTSIDE
 PARTY, IN WHOLE OR IN PART, WITHOUT WRITTEN PERMISSION OF MINI-CIRCUITS.

Evaluation Board and Circuit



Schematic Diagram

Notes:

1. SMA Female connectors.
2. PCB Material: ROGERS R04350 or equivalent, Dielectric Constant=3.5, Thickness=.020 inch.

 **Mini-Circuits®**

All Mini-Circuits products are manufactured under exacting quality assurance and control standards, and are capable of meeting published specifications after being subjected to any or all of the following physical and environmental test.

Specification	Test/Inspection Condition	Reference/Spec
Operating Temperature	-55° to 100°C Ambient Environment	Individual Model Data Sheet
Storage Temperature	-55° to 100° C Ambient Environment	Individual Model Data Sheet
Humidity	90 to 95% RH, 240 hours, 50°C	MIL-STD-202, Method 103, Condition A, Except 50°C and end-point electrical test done within 12 hours
Solder Reflow Heat	Sn-Pb Eutetic Process: 225°C peak Pb-Free Process 245° - 250°C peak	J-STD-020, Table 4-1, 4-2 and 5-2, Figure 5-1
Solderability	10X Magnification	J-STD-002, Para 4.2.5, Test S, 95% Coverage
Vibration (High Frequency)	20g peak, 10-2000 Hz, 12 times in each of three perpendicular directions (total 36)	MIL-STD-202, Method 204, Condition D
Mechanical Shock	50g, 11 ms, 1/2-sine, 18 shocks: 3 each direction, each of 3 axes	MIL-STD-202, Method 213, Condition A