



(LTCC) SURFACE MOUNT

Low Pass Filter

LFHK-5000+

50Ω

DC to 5000 MHz

THE BIG DEAL

- Low Insertion Loss, 1.4 dB Typ.
- Passband Return Loss, 13 dB Typ.
- Stopband Rejection, 76 dB Typ.
- 1008 Surface Mount Footprint
- Power Handling: 9.5 W
- Shielded Construction: Prevents De-Tuning & EMI
- Protected by US Patents 11,638,370 and 11,744,057

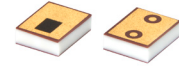

Generic photo used for illustration purposes only

APPLICATIONS

- Test and Measurement Equipment
- VHF/UHF Transmitters / Receivers
- Harmonic Rejection
- Satcom Modems

FUNCTIONAL DIAGRAM

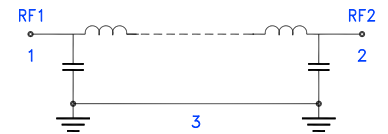

PRODUCT OVERVIEW

The LFHK-5000+ is a passive RF component designed for signal conditioning in low-frequency circuits. It utilizes ceramic-based construction to achieve stable electrical behaviour across a broad operating range. The device supports bidirectional signal flow and is optimized for integration into compact layouts, making it suitable for dense PCB designs. It's surface-mount format aligns with standard automated assembly processes, and the internal structure is engineered to minimize parasitic effects that could impact performance at microwave frequencies. The component is built to maintain consistent characteristics under varying environmental conditions, contributing to overall system reliability.

ELECTRICAL SPECIFICATIONS^{1,2,3} AT +25°C

Parameter	F#	Frequency (MHz)	Min.	Typ.	Max.	Units	
Passband	Insertion Loss	DC-F1	DC - 5000	—	1.4	2.2	dB
	Freq. Cut-Off ⁴	Fc	5750	—	3	—	
	Return Loss	DC-F1	DC - 5000	—	13	—	
Stopband	Rejection	F2-F3	6900 - 10200	20	32	—	dB
		F3-F4	10200 - 13000	64	76	—	
		F4-F5	13000 - 22000	—	62	—	
		F5-F6	22000 - 32000	—	51	—	
		F6-F7	32000 - 50000	—	38	—	

1. Tested in Evaluation Board P/N TB-LFHK-5000+.
2. This filter is bi-directional RF1 and RF2 ports may be interchanged, see S-Parameters for actual performance.
3. This component should not be used as a DC-block. In applications where DC voltage and/or current is present at either the input or output ports, external DC blocking capacitors are required.
4. Typical variation ± 5%.

ABSOLUTE MAXIMUM RATINGS⁵

Operating Temperature	-55°C to +125°C
Storage Temperature	-55°C to +125°C
Input Power ⁶	9.5 W @ +25°C

5. Permanent damage may occur if any of these limits are exceeded.
6. Power rating applies only to signals within the passband. Power rating above +25°C operating temperature decreases linearly to 1.6 W at +125°C.

TYPICAL FREQUENCY RESPONSE

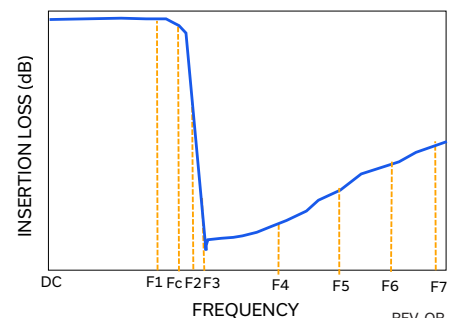



(LTCC) SURFACE MOUNT

Low Pass Filter

LFHK-5000+

Mini-Circuits

50Ω

DC to 5000 MHz

TYPICAL PERFORMANCE GRAPHS

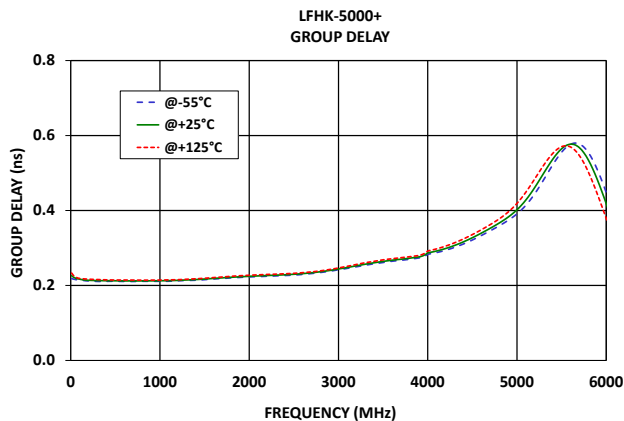
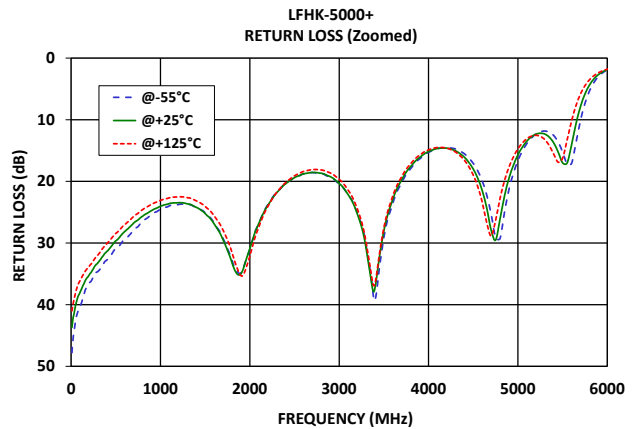
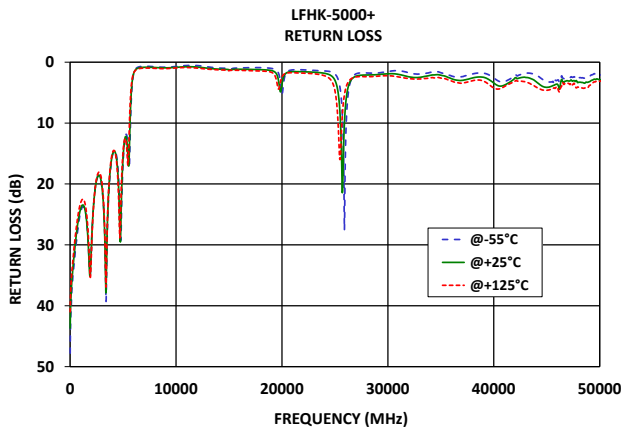
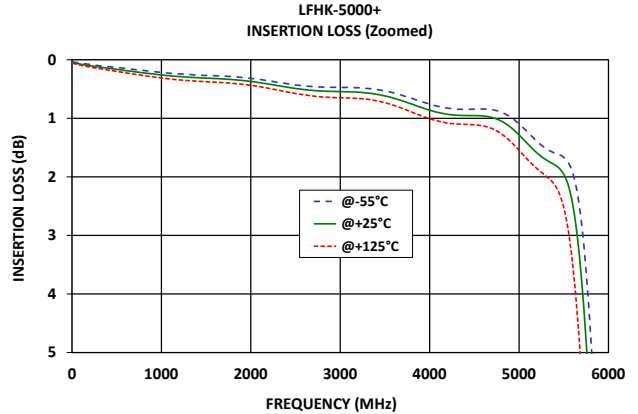
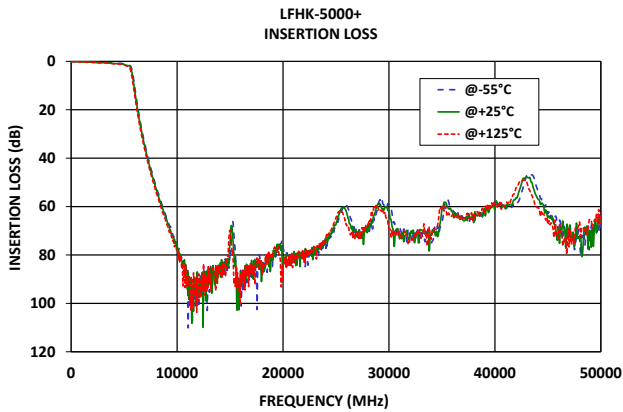



(LTCC) SURFACE MOUNT

Low Pass Filter

LFHK-5000+

Mini-Circuits

50Ω

DC to 5000 MHz

FUNCTIONAL DIAGRAM

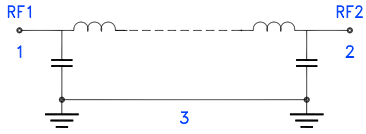
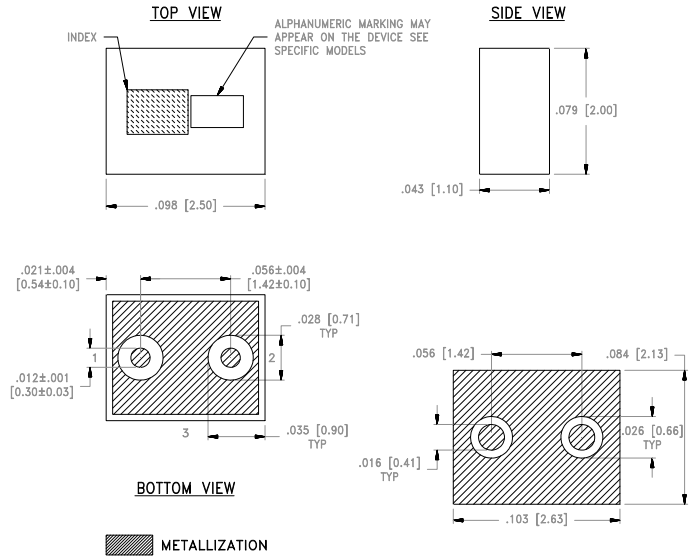

Figure 1. LFHK-5000+ Functional Diagram

PAD DESCRIPTION

Function	Pad Number	Description
RF1 ²	1	Connects to RF Input Port
RF2 ²	2	Connects to RF Output Port
GROUND	3	Connects to Ground on PCB, (See drawing PL-798)

CASE STYLE DRAWING



Weight: .019 grams.

Dimensions are in inches (mm). Tolerances: 2Pl. ± .01; 3Pl. ± .005

PRODUCT MARKING*: U8

*Marking may contain other features or characters for internal lot control.



SUGGESTED PCB LAYOUT

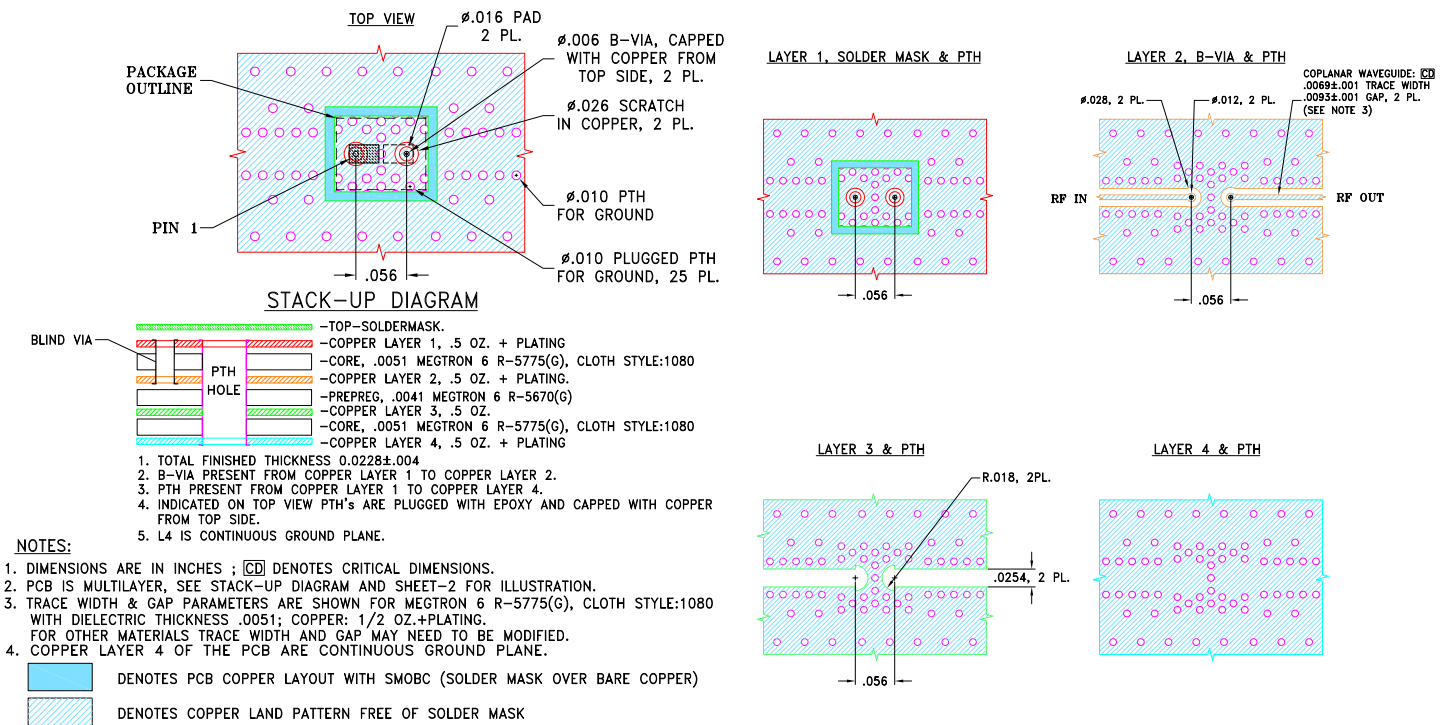

Figure 2. Suggested PCB Layout



(LTCC) SURFACE MOUNT

Low Pass Filter

LFHK-5000+

50Ω

DC to 5000 MHz

ADDITIONAL DETAILED INFORMATION IS AVAILABLE ON OUR DASHBOARD

[CLICK HERE](#)

Performance Data & Graphs	Data Graphs S-Parameter (S2P Files) Data Set (.zip file) De-embedded to device pads
Case Style	NL1008C-9 Lead Finish: Gold over Electroless Nickel
RoHS/REACH Status	Compliant
Tape and Reel	F75
Suggested Layout for PCB Design	PL-798
Evaluation Board	TB-LFHK-5000+ Gerber File
Environmental Rating	ENV06T10

NOTES

- A. Performance and quality attributes and conditions not expressly stated in this specification document are intended to be excluded and do not form a part of this specification document.
- B. Electrical specifications and performance data contained in this specification document are based on Mini-Circuits' applicable established test performance criteria and measurement instructions.
- C. The parts covered by this specification document are subject to Mini-Circuits' standard limited warranty and terms and conditions (collectively, "Standard Terms"); Purchasers of this part are entitled to the rights and benefits contained therein. For a full statement of the standard terms and the exclusive rights and remedies thereunder, please visit Mini-Circuits' website at www.minicircuits.com/terms/viewterm.html



Typical Performance Data

FREQ. (MHz)	INSERTION LOSS			INPUT RETURN LOSS			OUTPUT RETURN LOSS		
	(dB)			(dB)			(dB)		
	@-55°C	@+25°C	@+125°C	@-55°C	@+25°C	@+125°C	@-55°C	@+25°C	@+125°C
10	0.04	0.05	0.06	47.79	43.68	41.00	47.28	43.70	41.47
50	0.05	0.06	0.08	42.63	40.14	38.06	42.51	40.23	38.25
100	0.06	0.08	0.09	40.35	38.01	36.10	40.21	38.37	36.64
200	0.08	0.10	0.12	36.65	35.25	33.84	36.94	35.91	34.69
500	0.13	0.16	0.20	30.92	29.65	28.44	31.96	30.84	29.59
1000	0.22	0.26	0.31	24.51	24.04	23.08	24.82	24.44	23.44
1500	0.27	0.31	0.38	25.13	25.21	24.07	25.27	25.24	24.02
2000	0.32	0.37	0.44	31.04	30.90	32.13	30.80	30.41	30.64
2250	0.37	0.43	0.50	22.71	22.80	22.87	22.43	22.46	22.34
2800	0.47	0.54	0.64	18.75	18.69	18.15	18.42	18.36	17.81
3800	0.66	0.76	0.89	17.93	17.58	17.13	17.99	17.68	17.19
4000	0.76	0.86	1.01	15.29	15.16	14.89	15.31	15.21	14.91
4800	0.90	1.05	1.26	29.25	26.09	22.73	28.03	25.45	22.58
5000	1.10	1.28	1.55	16.60	15.69	14.72	16.65	15.75	14.80
5750	3.62	4.81	6.64	7.35	5.83	4.48	7.83	6.18	4.77
6000	10.50	12.04	14.05	1.90	1.86	1.80	2.04	2.00	1.97
6900	33.13	34.19	35.57	0.68	0.84	0.98	0.72	0.91	1.06
7000	35.10	36.12	37.47	0.67	0.83	0.97	0.70	0.89	1.04
7500	43.79	44.77	46.08	0.69	0.83	0.97	0.68	0.87	1.01
8000	51.37	52.35	53.72	0.75	0.87	1.01	0.74	0.92	1.06
8400	56.80	57.97	59.26	0.80	0.91	1.05	0.79	0.97	1.10
9000	64.54	65.13	67.11	0.82	0.93	1.05	0.83	1.02	1.14
9300	67.95	69.62	70.71	0.81	0.92	1.03	0.83	1.03	1.14
10000	76.20	78.22	77.91	0.70	0.85	0.95	0.77	0.97	1.08
10200	78.18	82.01	79.98	0.67	0.82	0.92	0.74	0.95	1.07
11000	86.41	94.40	90.32	0.55	0.75	0.88	0.59	0.82	0.97
11200	100.77	89.38	100.00	0.54	0.75	0.89	0.55	0.80	0.95
12000	99.17	92.79	91.00	0.56	0.80	0.97	0.58	0.86	1.04
12500	88.45	90.99	83.72	0.65	0.89	1.06	0.67	0.95	1.11
13000	86.83	92.36	89.72	0.77	0.99	1.14	0.75	1.02	1.16
13500	88.88	88.00	86.73	0.88	1.08	1.21	0.84	1.09	1.21
14000	86.63	84.07	85.42	0.96	1.14	1.26	0.91	1.15	1.26
14500	85.50	83.84	83.14	0.99	1.17	1.29	0.94	1.17	1.29
15000	79.49	75.39	69.75	1.02	1.24	1.39	0.96	1.23	1.40
15500	79.59	82.50	93.02	0.99	1.17	1.32	0.94	1.19	1.35
16000	86.33	87.13	87.76	0.95	1.16	1.34	0.89	1.18	1.37
17000	87.26	83.09	88.55	0.90	1.19	1.39	0.89	1.25	1.49
18000	83.20	89.54	84.60	0.90	1.23	1.45	0.91	1.30	1.54
19000	84.98	81.32	79.54	1.02	1.37	1.66	1.09	1.50	1.81
20000	76.75	82.95	84.96	5.30	3.67	2.44	7.17	4.69	2.84
21000	82.82	79.39	81.94	1.26	1.55	1.73	1.27	1.62	1.80
22000	80.33	80.48	83.09	1.26	1.57	1.80	1.20	1.63	1.85
25000	67.80	67.30	64.54	1.93	2.96	4.66	1.77	2.75	4.27
30000	58.95	61.28	68.90	1.54	1.91	2.22	1.36	1.82	2.09
31000	68.49	73.33	73.15	1.40	2.01	2.42	1.32	1.94	2.41
32000	73.43	71.69	72.85	1.74	2.40	2.69	1.76	2.55	2.98
35000	66.62	61.25	59.74	1.72	2.13	2.61	1.79	2.38	2.60
37000	64.75	65.63	64.79	2.37	2.98	3.45	2.11	2.82	3.39
39000	62.74	60.85	62.61	1.78	2.47	3.08	2.06	3.01	3.54
40000	60.14	61.41	57.92	2.60	3.43	4.23	2.95	3.79	4.45
41000	59.78	60.95	58.97	3.16	3.77	4.00	3.13	3.85	4.07
42000	58.47	56.34	52.26	2.06	2.58	3.12	1.93	2.61	3.21
43000	47.01	47.74	49.70	1.81	2.50	3.27	2.12	2.80	3.64
44000	52.70	56.46	60.48	2.14	3.21	4.09	2.06	3.35	4.26
45000	63.00	64.54	67.34	3.18	4.14	4.62	3.52	4.86	5.34
46000	69.36	68.67	72.90	2.97	3.61	4.09	3.73	4.23	4.71
47000	74.29	69.57	76.63	2.53	3.07	3.46	2.39	3.17	3.35
48000	73.68	72.24	66.51	2.56	3.29	4.12	2.13	2.94	3.59
49000	71.90	69.96	65.22	2.35	3.22	3.85	1.97	3.00	4.21
50000	68.66	66.34	62.62	2.03	2.87	3.15	2.27	3.45	3.89

Typical Performance Data

FREQ. (MHz)	GROUP DELAY		
	(nsec)		
	@-55°C	@+25°C	@+125°C
10	0.22	0.23	0.23
50	0.22	0.22	0.22
100	0.22	0.22	0.22
150	0.21	0.21	0.22
200	0.21	0.21	0.22
250	0.21	0.21	0.22
300	0.21	0.21	0.22
350	0.21	0.21	0.22
400	0.21	0.21	0.22
450	0.21	0.21	0.21
500	0.21	0.21	0.21
550	0.21	0.21	0.21
600	0.21	0.21	0.21
650	0.21	0.21	0.21
700	0.21	0.21	0.21
750	0.21	0.21	0.21
800	0.21	0.21	0.21
850	0.21	0.21	0.21
900	0.21	0.21	0.21
950	0.21	0.21	0.21
1000	0.21	0.21	0.21
1200	0.21	0.21	0.22
1300	0.21	0.21	0.22
1400	0.21	0.22	0.22
1500	0.22	0.22	0.22
2000	0.22	0.22	0.23
2200	0.22	0.23	0.23
2400	0.23	0.23	0.23
2600	0.23	0.23	0.23
2800	0.23	0.24	0.24
3000	0.24	0.24	0.25
3500	0.26	0.26	0.27
4000	0.28	0.29	0.29
4500	0.32	0.33	0.34
4800	0.36	0.37	0.38
5000	0.39	0.40	0.42

Typical Performance Curves

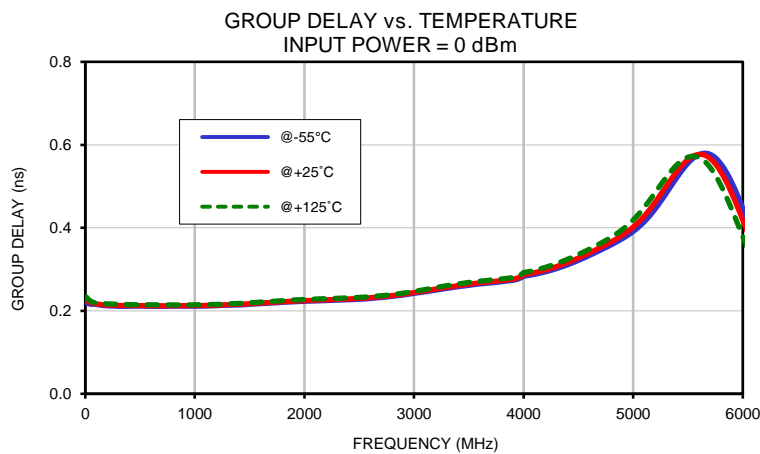
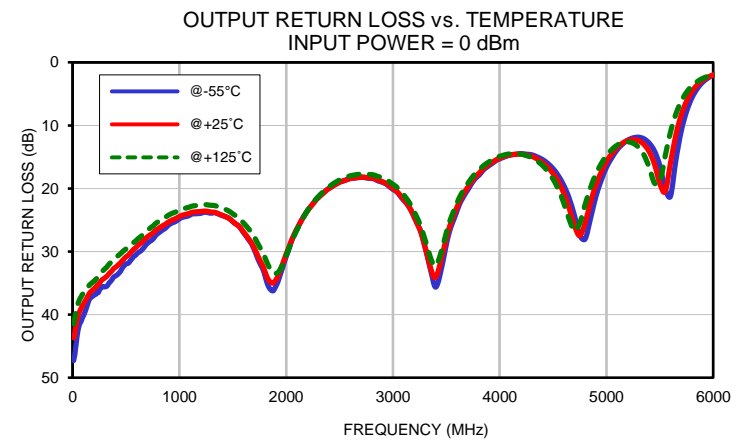
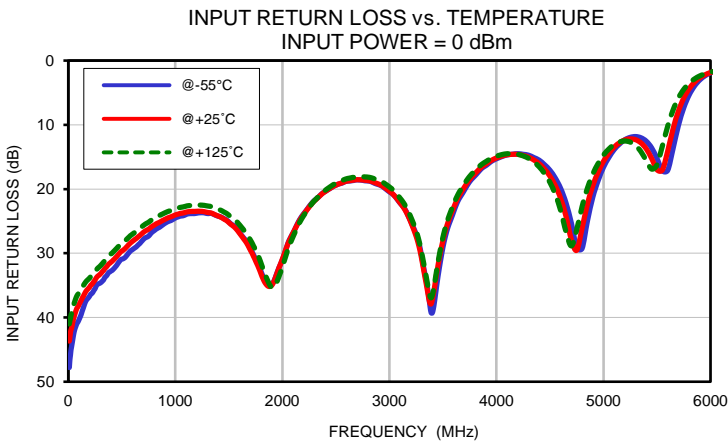
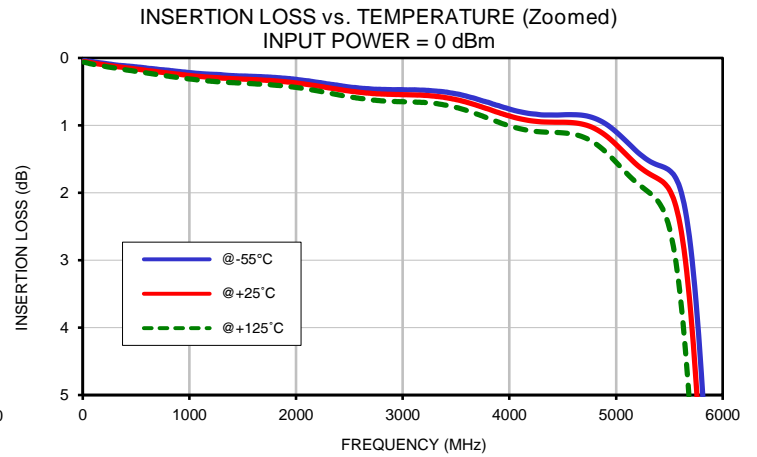
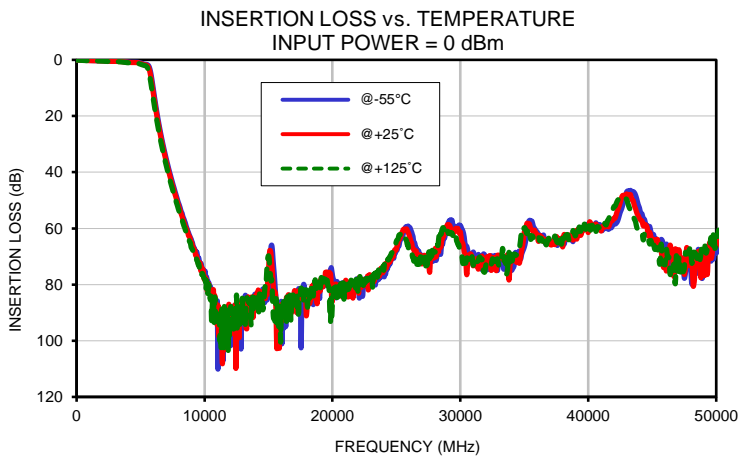

Case Style

NL

Outline Dimensions

NL1008C-9

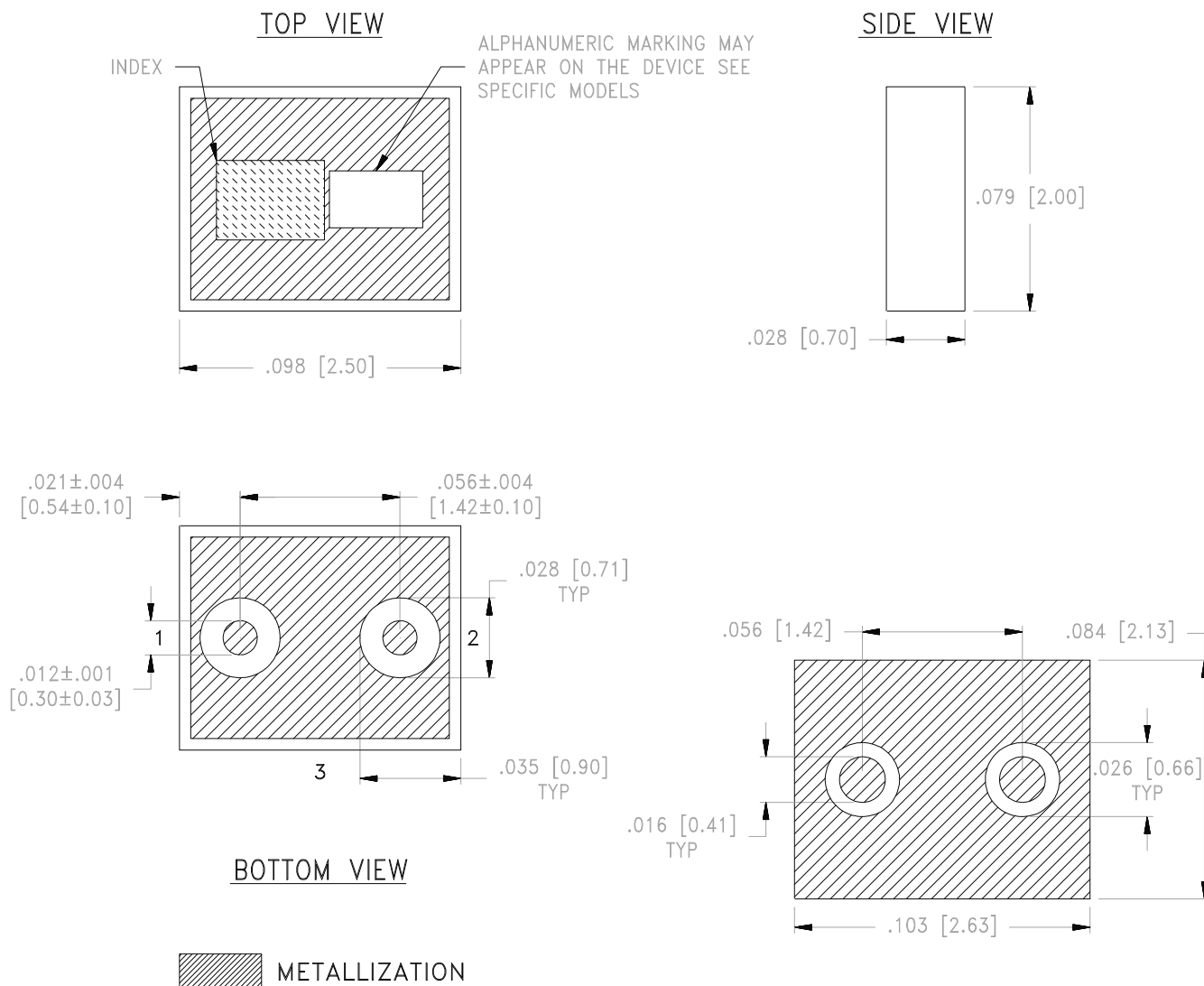

Dimensions are in inches (mm). Tolerances: 2Pl. ± .01; 3Pl. ± .005

Notes:

1. Open style, Ceramic base.
2. Termination finish: **as shown below or indicated on Data sheet.**
For RoHS Case Styles: Gold plate over nickel plate. All models, (+) suffix.
3. Weight: .019 grams.
4. Pad tolerance is non-cumulative.

Mini-Circuits®
ISO 9001 ISO 14001 CERTIFIED

ALL NEW
minicircuits.com

P.O. Box 350166, Brooklyn, New York 11235-0003 (718) 934-4500 Fax (718) 332-4661 For detailed performance specs & shopping online see Mini-Circuits web site



The Design Engineers Search Engine Provides ACTUAL Data Instantly From MINI-CIRCUITS At: www.minicircuits.com

RF/IF MICROWAVE COMPONENTS

DEVICE ORIENTATION IN T&R

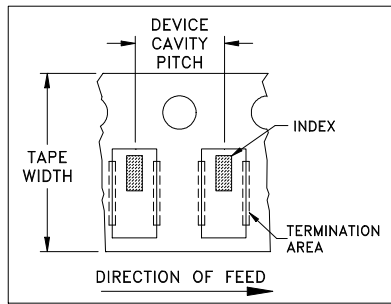

ILLUSTRATION 1

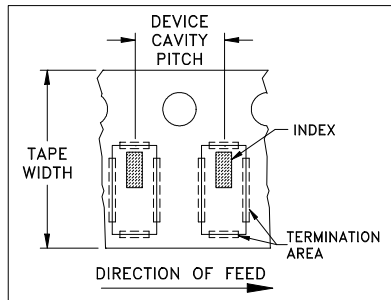

ILLUSTRATION 2

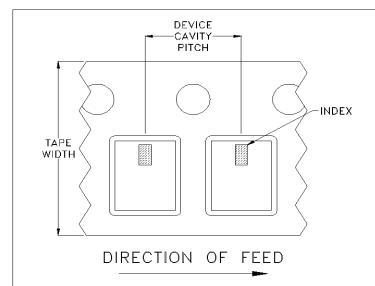

ILLUSTRATION 3

Applicable Case Styles

FV1206-1
FV1206-3

Applicable Case Styles

FV1206-4
FV1206-5
FV1206-6
FV1206-7
FV1206-9

Applicable Case Styles

FV1206-11
FV1206-12
GE0805C-18
NL1008C-6
NL1008C-7
NL1008C-9
NL1008C-10
NL1008C-12

Tape Width, mm	Device Cavity Pitch, mm	Reel Size, inches	Devices per Reel	
8	4	7	Small quantity standards (see note)	20
				50
				100
				200
				500
				1000
			Standard	3000

Note: Please consult individual model data sheet to determine device per reel availability.

Mini-Circuits carrier tape materials provide protection from ESD (Electro-Static Discharge) during handling and transportation. Tapes are static dissipative and comply with industry standards EIA-481/EIA-541.

Go to: www.minicircuits.com/pages/pdfs/tape.pdf



INTERNET <http://www.minicircuits.com>
 P.O. Box 350166, Brooklyn, New York 11235-0003 (718) 934-4500 Fax (718) 332-4661
 Distribution Centers NORTH AMERICA 800-654-7949 • 417-335-5935 • Fax 417-335-5945 • EUROPE 44-1252-832600 • Fax 44-1252-837010
 Mini-Circuits ISO 9001 & ISO 14001 Certified

THIRD ANGLE PROJECTION

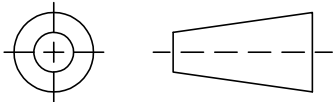

REVISIONS

REV OR	ECN No.	DESCRIPTION	DATE	DR	AUTH
	ECO-023057	NEW RELEASE	SEP 24	AGS	GT

SUGGESTED MOUNTING CONFIGURATION FOR NL1008C-9 CASE STYLE

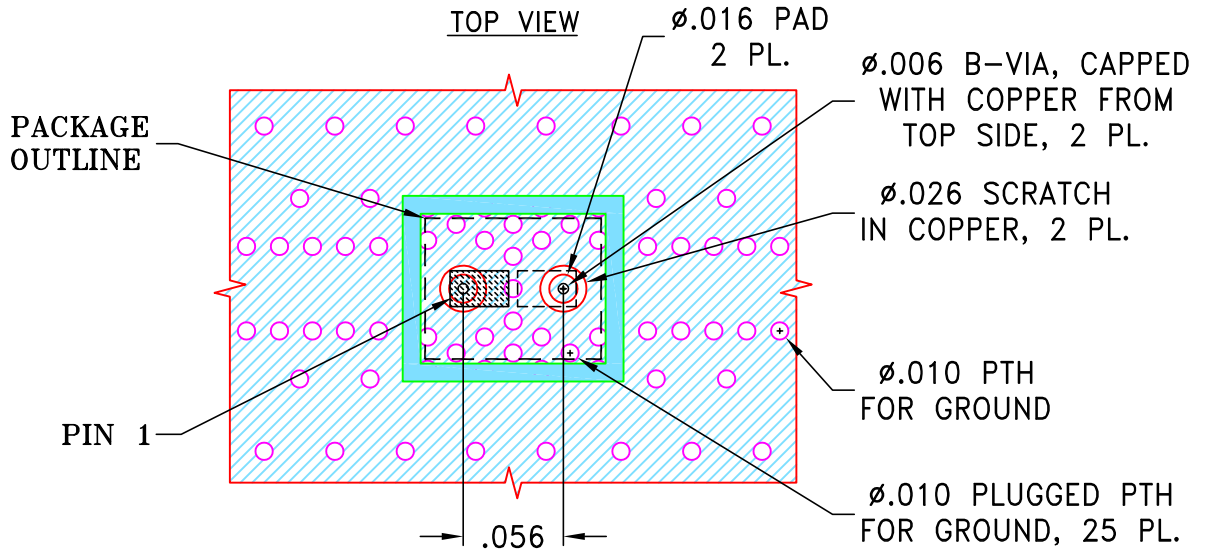

STACK-UP DIAGRAM

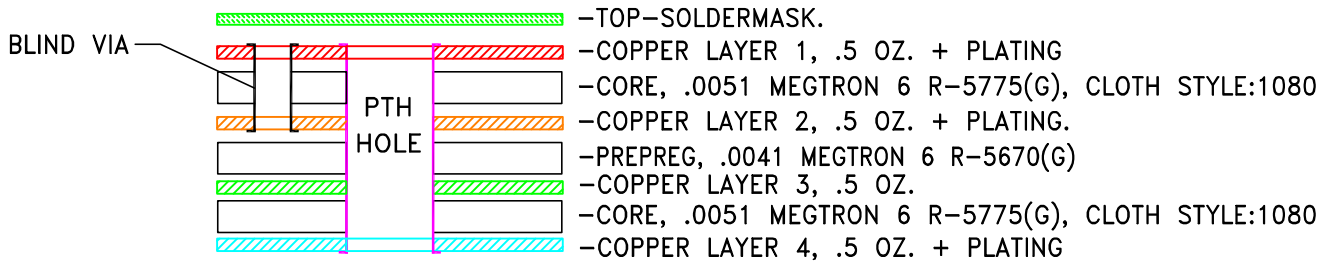

- TOTAL FINISHED THICKNESS 0.0228±.004 .
- B-VIA PRESENT FROM COPPER LAYER 1 TO COPPER LAYER 2.
- PTH PRESENT FROM COPPER LAYER 1 TO COPPER LAYER 4.
- INDICATED ON TOP VIEW PTH'S ARE PLUGGED WITH EPOXY AND CAPPED WITH COPPER FROM TOP SIDE.
- L4 IS CONTINUOUS GROUND PLANE.

NOTES:

- PCB IS MULTILAYER, SEE STACK-UP DIAGRAM AND SHEET-2 FOR ILLUSTRATION.
- TRACE WIDTH & GAP PARAMETERS ARE SHOWN FOR MEGTRON6 R-5775(G), CLOTH STYLE:1080 WITH DIELECTRIC THICKNESS .0051; COPPER: 1/2 OZ.+PLATING.
FOR OTHER MATERIALS TRACE WIDTH AND GAP MAY NEED TO BE MODIFIED.
- COPPER LAYER 4 OF THE PCB ARE CONTINUOUS GROUND PLANE.



DENOTES PCB COPPER LAYOUT WITH SMOBC (SOLDER MASK OVER BARE COPPER)

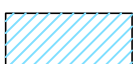

DENOTES COPPER LAND PATTERN FREE OF SOLDER MASK

UNLESS OTHERWISE SPECIFIED	INITIALS	DATE
DIMENSIONS ARE IN INCHES	DRAWN AGS	14 SEP 24
TOLERANCES ON:	CHECKED MD	16 SEP 24
2 PL DECIMALS ±	APPROVED GTP	17 SEP 24
3 PL DECIMALS ± .002		
ANGLES ±		
FRACTIONS ±		



Mini-Circuits®

13 Neptune Avenue
Brooklyn NY 11235

PL, NL1008C-9, TB-LFHK-XXXX+

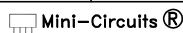

THIS DOCUMENT AND ITS CONTENTS ARE THE PROPERTY OF MINI-CIRCUITS. EXCEPT FOR USE EXPRESSLY GRANTED, IN WRITING, TO ITS VENDORS, VENDEE AND THE UNITED STATES GOVERNMENT, MINI-CIRCUITS RESERVES ALL PROPRIETARY DESIGN, USE, MANUFACTURING AND REPRODUCTION RIGHTS THERETO. THESE CONTENTS SHALL NOT BE USED, DUPLICATED OR DISCLOSED TO ANY OUTSIDE PARTY, IN WHOLE OR IN PART, WITHOUT WRITTEN PERMISSION OF MINI-CIRCUITS.

SIZE	CODE IDENT	DRAWING NO:	REV:
A	15542	98-PL-798	OR
FILE:	98-PL-798	SCALE:	SHEET:
		9:1	1 OF 2

LAYER 1, SOLDER MASK & PTH

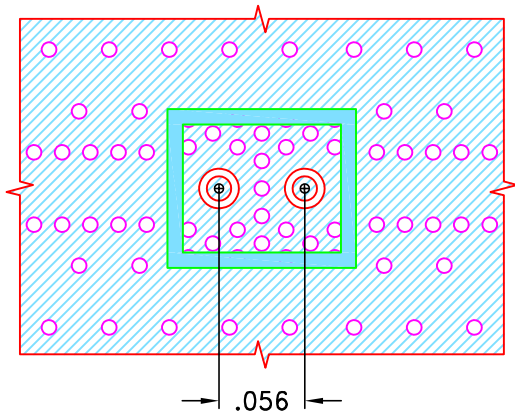

LAYER 2, B-VIA & PTH

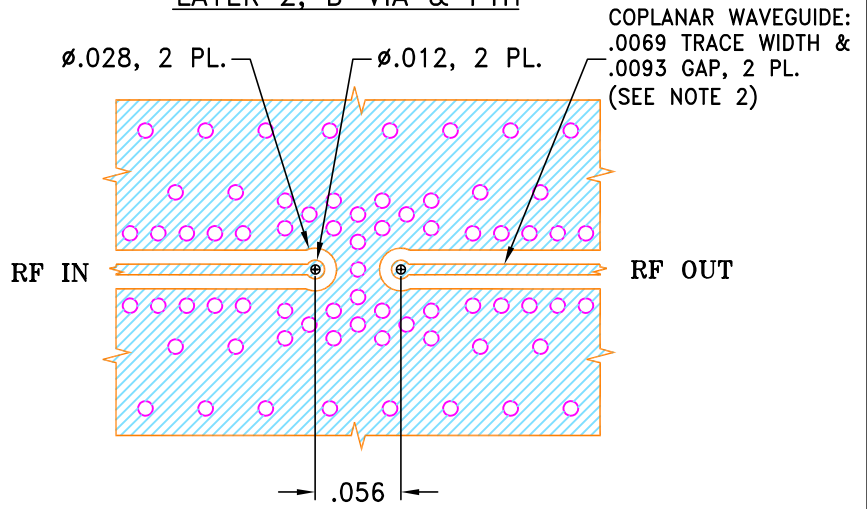

LAYER 3 & PTH

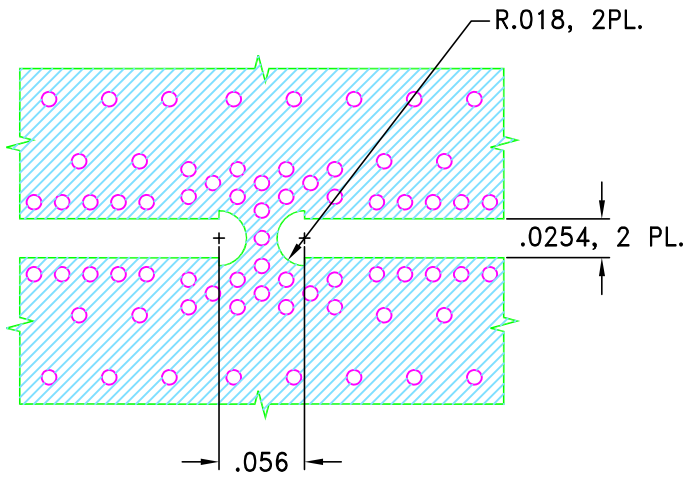

LAYER 4 & PTH

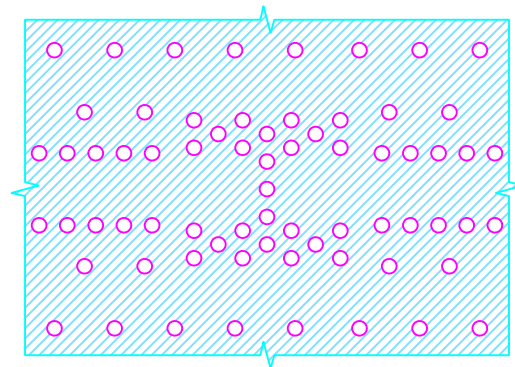

Mini-Circuits

THIS DOCUMENT AND ITS CONTENTS ARE THE PROPERTY OF MINI-CIRCUITS. EXCEPT FOR USE EXPRESSLY GRANTED, IN WRITING, TO ITS VENDORS, VENDEE AND THE UNITED STATES GOVERNMENT, MINI-CIRCUITS RESERVES ALL PROPRIETARY DESIGN, USE, MANUFACTURING AND REPRODUCTION RIGHTS THERETO. THESE CONTENTS SHALL NOT BE USED, DUPLICATED OR DISCLOSED TO ANY OUTSIDE PARTY, IN WHOLE OR IN PART, WITHOUT WRITTEN PERMISSION OF MINI-CIRCUITS.

ALL DIMENSIONS ARE IN INCHES EXCEPT OTHERWISE SPECIFIED

SIZE A	CODE IDENT 15542	DRAWING NO: 98-PL-798	REV: OR
FILE:	98-PL-798	SCALE: 7.7:1	SHEET: 2 OF 2

Evaluation Board and Circuit

TB-LFHK-5000+

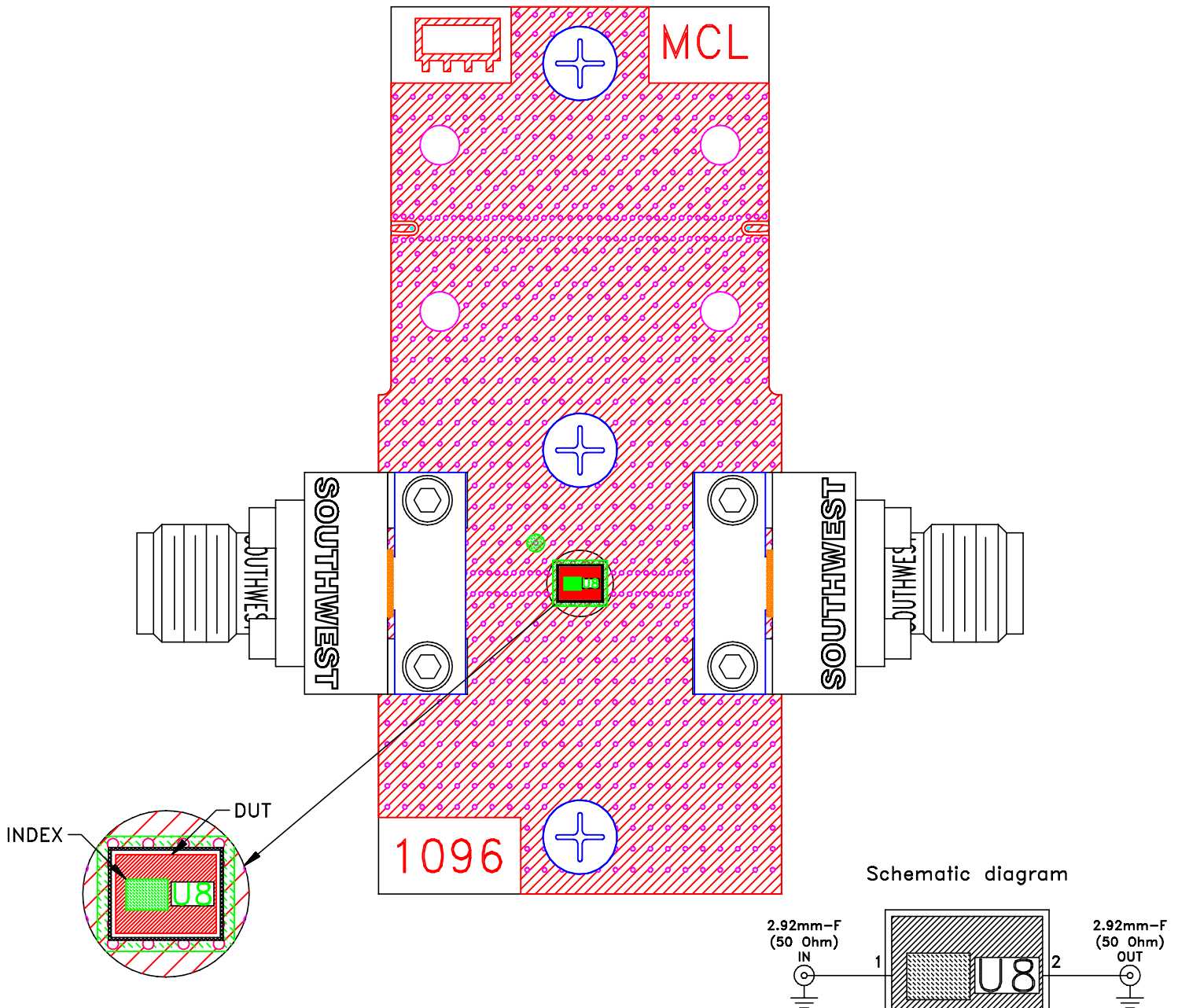

Schematic diagram

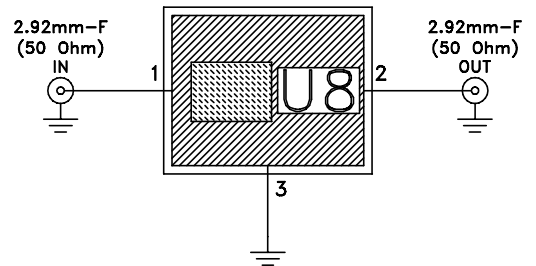

STACK-UP DIAGRAM

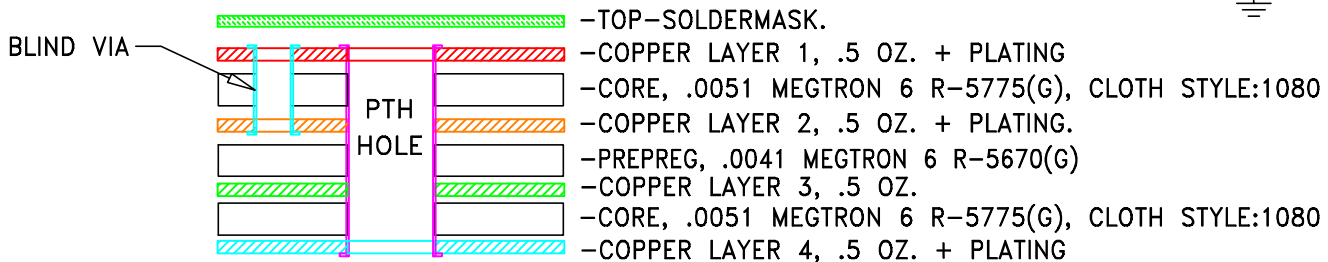

Notes:

1. PCB Material: MEGTRON-6 R5775(G) OR Equivalent, Dielectric Constant=3.6
2. Total finished thickness: .023 inch
3. 50 Ohm 2.92mm Female End Launch Connector.

 **Mini-Circuits®**



All Mini-Circuits products are manufactured under exacting quality assurance and control standards, and are capable of meeting published specifications after being subjected to any or all of the following physical and environmental test.

Specification	Test/Inspection Condition	Reference/Spec
Operating Temperature	-55° to 125° C Ambient Environment	Individual Model Data Sheet
Storage Temperature	-55° to 125° C Ambient Environment	Individual Model Data Sheet
Humidity	90 to 95% RH, 240 hours, 50°C	MIL-STD-202, Method 103, Condition A, Except 50°C and end-point electrical test done within 12 hours
Solder Reflow Heat	Sn-Pb Eutectic Process 225°C peak Pb-Free Process 245° - 250°C peak	J-STD-020C, Table 4-1, 4-2 and 5-2, Figure 5-1
Solderability	10X Magnification	J-STD-002, Test B,B1, 95% Coverage
Thermal Shock	-55° to +125°C, 15 min dwell,250 cycles	MIL-STD-202, Method 107
Bend Test	1mm, deflection for 5 seconds Span of bending: 2.75"	--
High Temp Storage	125°C to 1000 Hrs	---