

# Ceramic Low Pass Filter

50Ω DC to 1700 MHz

## LFTC-1700+

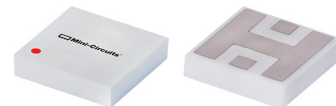

Generic photo used for illustration purposes only

CASE STYLE: FR933

### Maximum Ratings

Operating Temperature	-55°C to 100°C
Storage Temperature	-55°C to 125°C

Permanent damage may occur if any of these limits are exceeded.

### Pin Connections

RF IN	2
RF OUT	5
GROUND	1,3,4,6

### Product Marking: LF4

### Outline Drawing

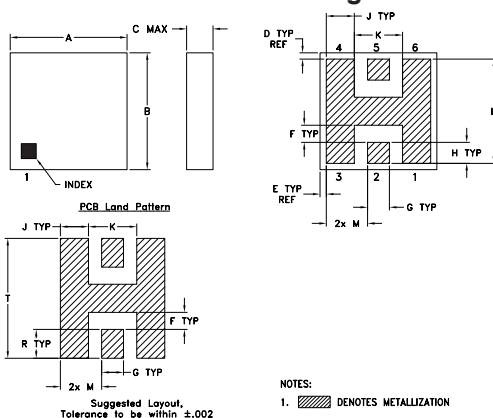

### Outline Dimensions (inch/mm)

A	B	C	D	E	F	G	H
.150	.150	.034	.008	.008	.022	.028	.027
3.81	3.81	0.864	0.203	0.203	0.559	0.711	0.686
J	K	L	M	R	T	wt	
.036	.062	.134	.053	.037	.154	grams	
0.914	1.575	3.404	1.346	0.940	3.912	0.15	

### Demo Board MCL P/N: TB-233 Suggested PCB Layout (PL-112)

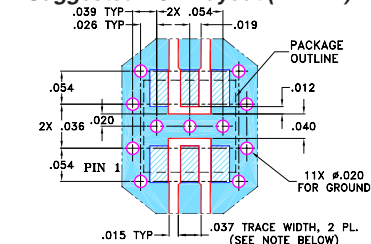

NOTES: 1. TRACE WIDTH IS SHOWN FOR ROGERS RO4350B WITH DIELECTRIC THICKNESS 0.020" ± 0.0015"; COPPER: 1/2 OZ. EACH SIDE. FOR OTHER MATERIALS TRACE WIDTH MAY NEED TO BE MODIFIED.

2. BOTTOM SIDE OF THE PCB IS CONTINUOUS GROUND PLANE.
- DENOTES PCB COPPER LAYOUT WITH SMOBC (SOLDER MASK OVER BARE COPPER)
  - DENOTES COPPER LAND PATTERN FREE OF SOLDER MASK

### Notes

- A. Performance and quality attributes and conditions not expressly stated in this specification document are intended to be excluded and do not form a part of this specification document.
- B. Electrical specifications and performance data contained in this specification document are based on Mini-Circuit's applicable established test performance criteria and measurement instructions.
- C. The parts covered by this specification document are subject to Mini-Circuits standard limited warranty and terms and conditions (collectively, "Standard Terms"); Purchasers of this part are entitled to the rights and benefits contained therein. For a full statement of the Standard Terms and the exclusive rights and remedies thereunder, please visit Mini-Circuits' website at [www.minicircuits.com/MCLStore/terms.jsp](http://www.minicircuits.com/MCLStore/terms.jsp)

### Features

- miniature size, 0.15"X0.15"X0.034"
- low profile, 0.034" height
- excellent power handling, 14W
- hermetically sealed

### Applications

- harmonic rejection
- internal rejection
- receivers & transmitters

### Electrical Specifications<sup>1</sup> (T<sub>AMB</sub>=25°C)

PASSBAND (MHz)	f <sub>co</sub> , MHz Nom.	STOP BAND (MHz)		VSWR (:1) Passband	POWER INPUT* (W)	MARKING	NO. OF SECTIONS
(loss < 1 dB)	(loss 3 dB)	( > 20 dB)	(loss > 40 dB)	fr20 dB			
Typ.	Typ.	Typ.	Typ.	Typ.			
DC-1700	1980	2700	3300-3750	7200	1.2	14	LF4

\* Derate linearly to 6W at 100°C ambient.

1. Measured on Mini-Circuits Characterization Test Board TB-233.

### typical frequency response

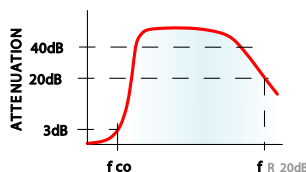

### electrical schematic



### Typical Performance Data at 25°C

Frequency (MHz)	Insertion Loss (dB)	VSWR (:1)
1.00	0.04	1.01
1000.00	0.43	1.17
1700.00	0.82	1.17
1980.00	2.94	3.21
2700.00	24.07	36.29
3300.00	44.62	45.32
3880.00	43.57	48.21
5000.00	36.48	59.14
7200.00	24.33	45.18
9000.00	8.94	7.75

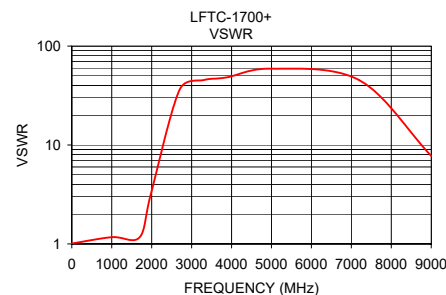
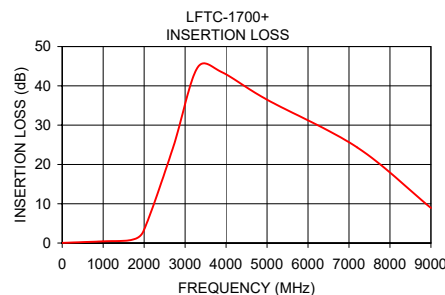

# Ceramic Low Pass Filter

# LFTC-1700+

## Typical Performance Data

FREQUENCY (MHz)	INSERTION LOSS @ +25° C (dB)	INPUT RETURN LOSS @ +25° C (dB)	OUTPUT RETURNLOSS @ +25° C (dB)
1	0.04	46.06	46.06
50	0.13	33.66	33.97
100	0.15	33.15	33.18
500	0.31	35.52	39.17
1000	0.52	21.91	21.82
1500	0.73	27.62	28.02
1700	0.91	25.03	24.47
1740	0.97	22.01	21.43
1980	2.77	6.62	6.42
1990	2.94	6.21	6.03
2075	4.89	3.60	3.51
2230	9.79	1.50	1.46
2380	14.87	0.90	0.84
2535	19.85	0.68	0.60
2700	24.89	0.58	0.49
2865	29.89	0.52	0.44
3020	34.91	0.48	0.40
3155	40.02	0.46	0.38
3300	47.86	0.42	0.36
3330	50.27	0.43	0.37
3380	55.71	0.42	0.35
3415	61.09	0.41	0.34
3440	63.36	0.42	0.34
3545	52.26	0.41	0.34
3700	46.24	0.41	0.33
3880	43.30	0.42	0.31
4200	41.04	0.45	0.30
5000	38.48	0.44	0.30
5500	36.02	0.52	0.33
5980	33.00	0.54	0.39
6300	31.45	0.59	0.43
6900	27.26	0.76	0.58
7200	25.15	0.91	0.74
7610	20.33	2.95	5.99
7800	28.05	2.87	1.33
7930	28.87	1.28	0.95
8300	22.86	1.40	1.35
8400	14.66	2.53	2.75
8800	12.32	1.58	2.12
9100	8.57	3.37	16.19
10000	12.75	4.38	2.60

REV. X1  
LFTC-1700+  
071007  
Page 1 of 1



IF/RF MICROWAVE COMPONENTS • ISO 9001 ISO 14001 AS 9100 CERTIFIED • RoHS compliant  
P.O. Box 350166, Brooklyn, New York 11235-0003 (718) 934-4500 Fax (718) 332-4661



The Design Engineers Search Engine finds the model you need, Instantly • For detailed performance specs & shopping online see



## Typical Performance Curves

### INSERTION LOSS

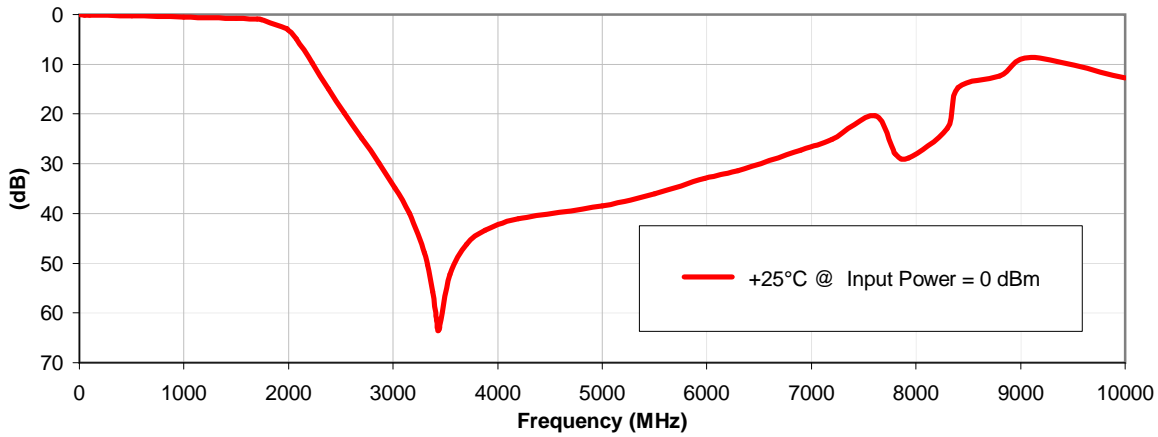

### INPUT RETURN LOSS

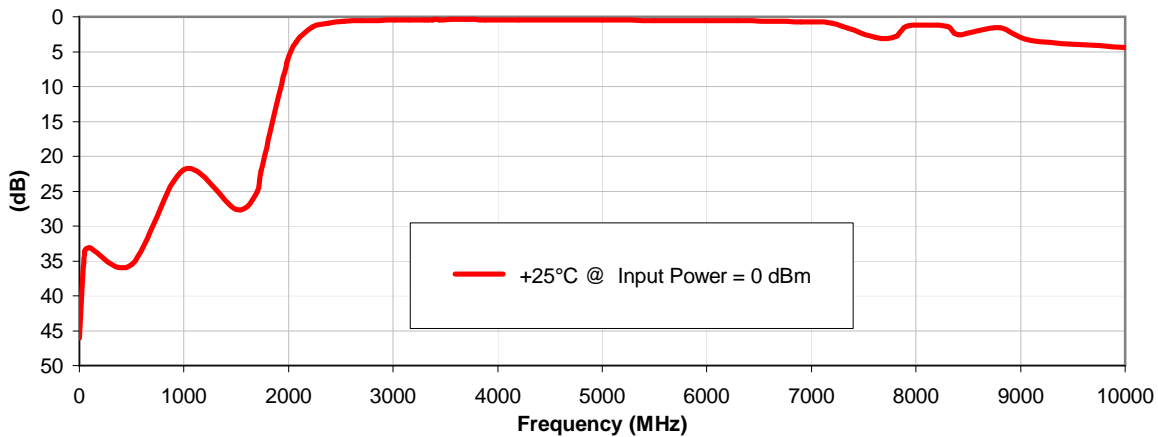

### OUTPUT RETURN LOSS

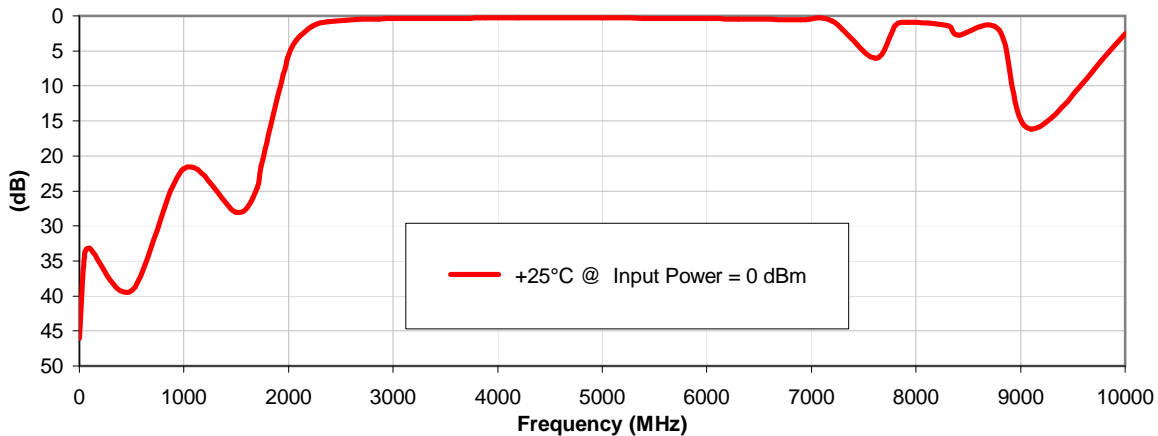

### Outline Dimensions

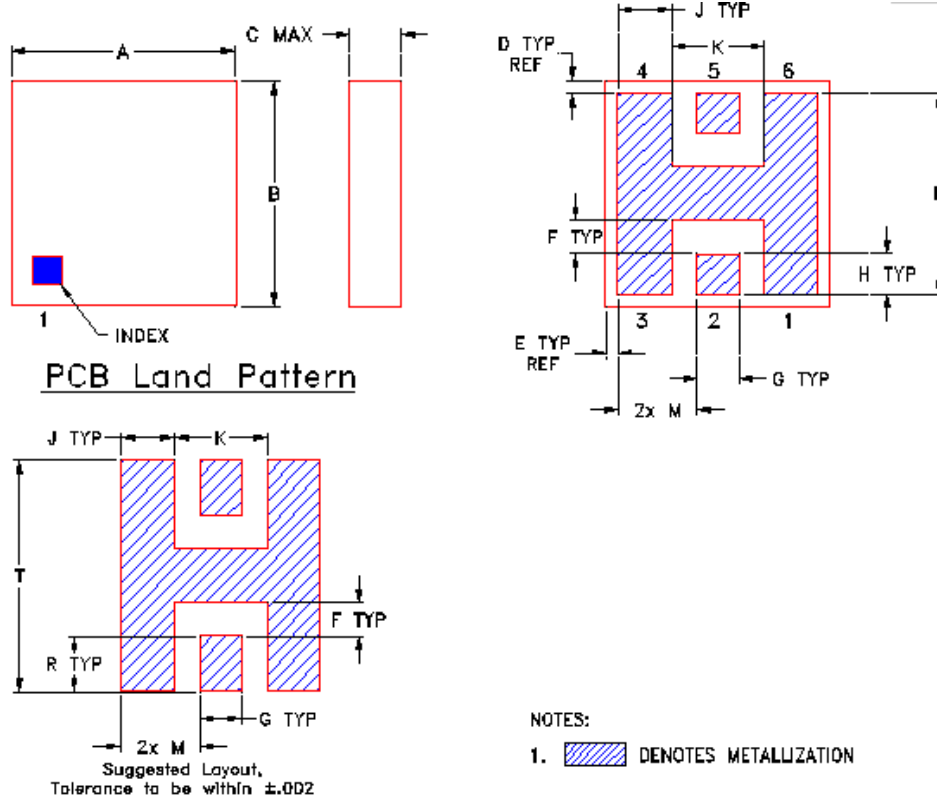

CASE #	A	B	C	D	E	F	G	H	J	K	L	M	R
FR933	.150 (3.81)	.150 (3.81)	.034 (.864)	.008 (.203)	.008 (.203)	.022 (.559)	.028 (.711)	.027 (.686)	.036 (.914)	.062 (1.575)	.134 (3.404)	.053 (1.346)	.037 (.940)

CASE #	T	WT. GRAM
FR933	.154 (3.912)	0.15

Dimensions are in inches (mm). Tolerances: 2Pl.  $\pm .01$ ; 3 Pl.  $\pm .005$

#### Notes:

1. Open style, Ceramic Base.
2. Termination finish: Palladium Silver.

# Tape & Reel Packaging TR-F68

## DEVICE ORIENTATION IN T&R

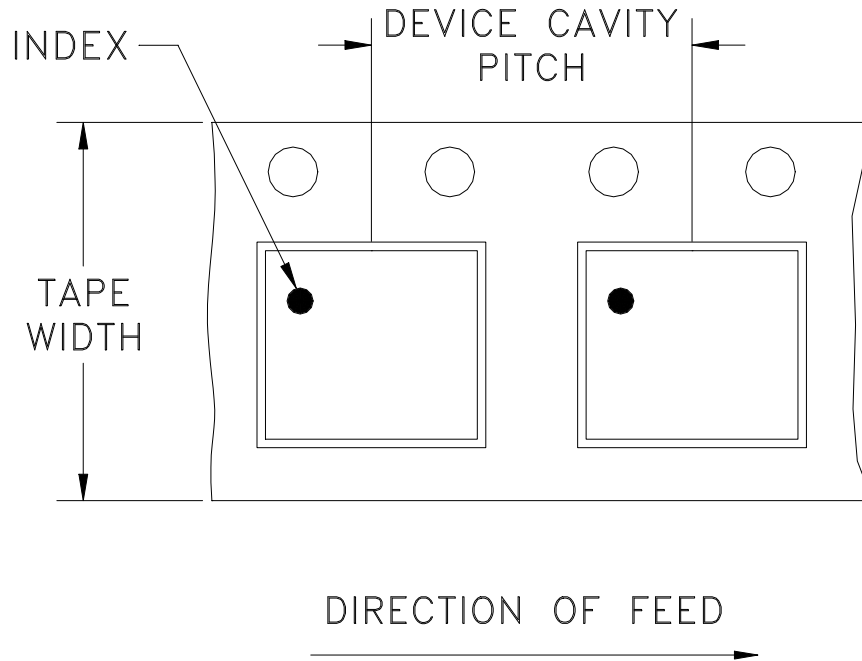

Tape Width, mm	Device Cavity Pitch, mm	Reel Size, inches	Devices per Reel see note	
12	8	7	Small quantity standard	20
				50
				100
				200
				500
		7	Standard	1000
		13	Standard	2000
				3000
				4000

Mini-Circuits carrier tape materials provide protection from ESD (Electro-Static Discharge) during handling and transportation. Tapes are static dissipative and comply with industry standards EIA-481/EIA-541.

Go to: [www.minicircuits.com/pages/pdfs/tape.pdf](http://www.minicircuits.com/pages/pdfs/tape.pdf)



INTERNET <http://www.minicircuits.com>

P.O. Box 350166, Brooklyn, New York 11235-0003 (718) 934-4500 Fax (718) 332-4661

Distribution Centers NORTH AMERICA 800-654-7949 • 417-335-5935 • Fax 417-335-5945 • EUROPE 44-1252-832600 • Fax 44-1252-837010

Mini-Circuits ISO 9001 & ISO 14001 Certified

THIRD ANGLE PROJECTION

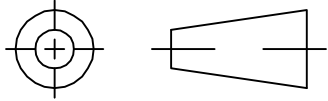

REVISIONS

REV	ECN No.	DESCRIPTION	DATE	DR	AUTH
OR	M83007	NEW RELEASE	09/04/02	MMG	LER
A	M83501	CNG LAYOUT AS PER B14-TB-233	10/01/02	MMG	ABD
B	M102713	ADDED "...WITH SMOBC"	01/14/06	GF	IL
C	M164713	ADDED "933-1 & 06FL03"	11/15/17	CA	IL

**SUGGESTED MOUNTING CONFIGURATION  
FOR FR932/933/933-1 CASE STYLE, "06FL03" PIN CONNECTION**

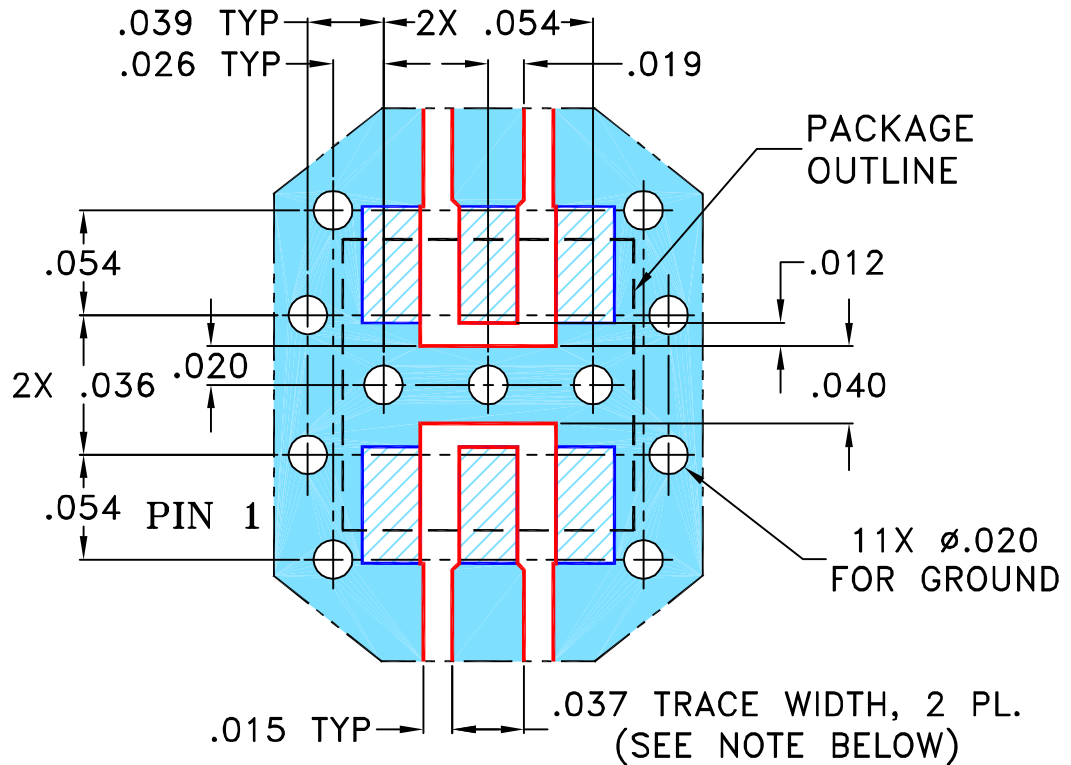

NOTES: 1. TRACE WIDTH IS SHOWN FOR ROGERS R04350B WITH DIELECTRIC THICKNESS 0.020" ± 0.0015"; COPPER: 1/2 OZ. EACH SIDE. FOR OTHER MATERIALS TRACE WIDTH MAY NEED TO BE MODIFIED.

2. BOTTOM SIDE OF THE PCB IS CONTINUOUS GROUND PLANE.



DENOTES PCB COPPER LAYOUT WITH SMOBC (SOLDER MASK OVER BARE COPPER)



DENOTES COPPER LAND PATTERN FREE OF SOLDER MASK

UNLESS OTHERWISE SPECIFIED	INITIALS		DATE
DIMENSIONS ARE IN INCHES TOLERANCES ON: 2 PL DECIMALS ± 3 PL DECIMALS ± ANGLES ± FRACTIONS ±	DRAWN	MMG	09/04/02
	CHECKED		
	APPROVED	LER(BC)	09/04/02



Mini-Circuits®

13 Neptune Avenue  
Brooklyn NY 11235

PL, 06FL03, FR932/933/933-1, TB-233

THIS DOCUMENT AND ITS CONTENTS ARE THE PROPERTY OF MINI-CIRCUITS. EXCEPT FOR USE EXPRESSLY GRANTED, IN WRITING, TO ITS VENDORS, VENDEE AND THE UNITED STATES GOVERNMENT, MINI-CIRCUITS RESERVES ALL PROPRIETARY DESIGN, USE, MANUFACTURING AND REPRODUCTION RIGHTS THERETO. THESE CONTENTS SHALL NOT BE USED, DUPLICATED OR DISCLOSED TO ANY OUTSIDE PARTY, IN WHOLE OR IN PART, WITHOUT WRITTEN PERMISSION OF MINI-CIRCUITS.

SIZE	CODE IDENT	DRAWING NO:	REV:
A	15542	98-PL-112	C
FILE:	98PL112	SCALE:	10:1
		SHEET:	1 OF 1

# Evaluation Board and Circuit

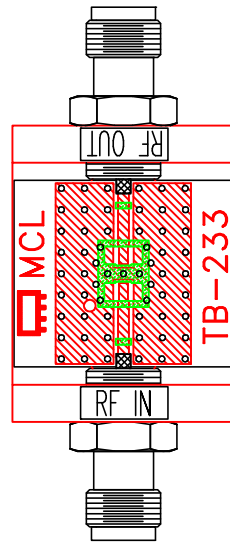

TB-233

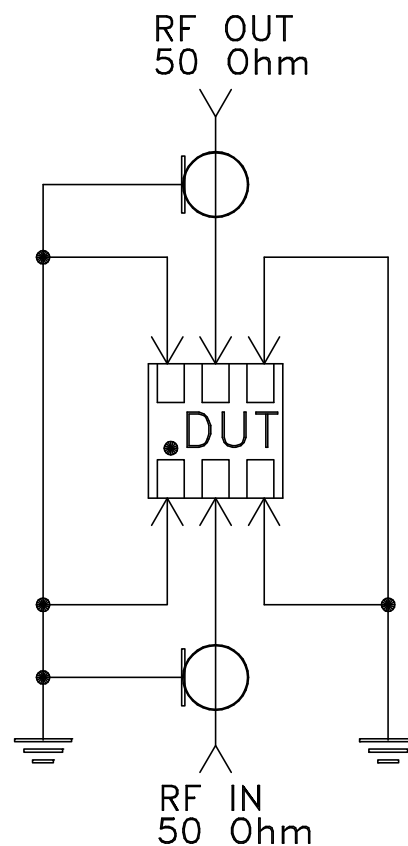

Schematic Diagram

## Notes:

1. SMA Female connectors.
2. PCB Material: Rogers R04350 or equivalent,  
Dielectric Constant=3.5, Thickness=.020 inch.

 **Mini-Circuits®**

All Mini-Circuits products are manufactured under exacting quality assurance and control standards, and are capable of meeting published specifications after being subjected to any or all of the following physical and environmental test.

Specification	Test/Inspection Condition	Reference/Spec
Operating Temperature	-55° to 100°C Ambient Environment	Individual Model Data Sheet
Storage Temperature	-55° to 125° C Ambient Environment	Individual Model Data Sheet
Humidity	90 to 95% RH, 240 hours, 50°C	MIL-STD-202, Method 103, Condition A, Except 50°C and end-point electrical test done within 12 hours
Thermal Shock	-55° to 100°C, 100 cycles	MIL-STD-202, Method 107, Condition A-3, except +100°C
Solder Reflow Heat	Sn-Pb Eutetic Process: 225°C peak Pb-Free Process 245° - 250°C peak	J-STD-020, Table 4-1, 4-2 and 5-2, Figure 5-1
Solderability	10X Magnification	J-STD-002, Para 4.2.5, Test S, 95% Coverage
Vibration (High Frequency)	20g peak, 10-2000 Hz, 12 times in each of three perpendicular directions (total 36)	MIL-STD-202, Method 204, Condition D
Mechanical Shock	50g, 11 ms, 1/2-sine, 18 shocks: 3 each direction, each of 3 axes	MIL-STD-202, Method 213, Condition A