

Nano-Second Switching

SPDT RF Switch Die M3SWA263DRC-D+

50Ω DC to 6000 MHz Absorptive RF Switch with internal driver

The Big Deal

- High Isolation, 63 dB typ. at 1GHz
- High IIP3, +44dBm typ. at 1GHz
- Low insertion loss, 0.5 dB typ. at 1GHz
- Fast Rise/Fall time, 5.6 ns / 6 ns typ.

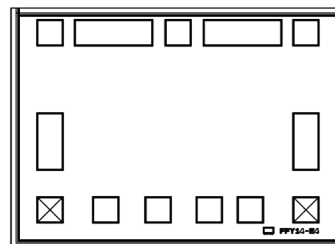

Product Overview

Mini-Circuits' M3SWA263DRC-D+ is a MMIC SPDT absorptive switch die with an internal driver designed for wideband operation from DC to 6 GHz supporting many applications requiring nano-second switching across a wide frequency range. This model provides excellent isolation and high linearity.

Key Features

Feature	Advantages
Wideband, DC to 6 GHz	One model can be used in many applications, saving component count. Also ideal for wideband applications such as military and instrumentation.
Absorptive switch	In the OFF condition, RF output ports which are not switched ON are terminated into 50 . This enables proper impedance termination of the circuitry following the RF output ports, preventing any unintended action such as oscillation.
High Isolation: <ul style="list-style-type: none">• 63 dB at 1 GHz• 29 dB at 6 GHz	High isolation significantly reduces leakage of power into OFF ports.
High linearity: Pin at P1dB 26.2dBm typ. at 1GHz, Input IP3, 44dBm typ. at 1GHz	High linearity minimizes unwanted intermodulation products which are difficult or impossible to filter in multi-carrier environments such as CATV, or in the presence of strong interfering signal from adjacent circuitry or received by antenna.
Unpackaged die	Enables user to integrate it directly into hybrids.



Nano-Second Switching

SPDT RF Switch Die

M3SWA263DRC-D+

50Ω DC to 6000 MHz Absorptive RF Switch with internal driver

Product Features

- High Isolation, 63 dB typ. at 1GHz
- High IIP3, +44 dBm typ. at 1GHz
- Low insertion loss, 0.5 dB typ. at 1 GHz
- Fast Rise/Fall time, 5.6 ns / 6 ns typ.

Typical Applications

- Defense
- Communication Infrastructure
- Test and Measurements

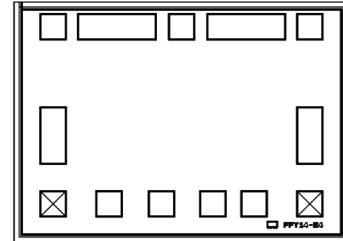

+RoHS Compliant
The +Suffix identifies RoHS Compliance. See our web site for RoHS Compliance methodologies and qualifications

Ordering Information: Refer to Last Page

General Description

Mini-Circuits' M3SWA263DRC-D+ is a MMIC SPDT absorptive switch die with an internal driver designed for wideband operation from DC to 6 GHz supporting many applications requiring nano-second switching across a wide frequency range. This model provides excellent isolation and high linearity.

Simplified Schematic and Pad description

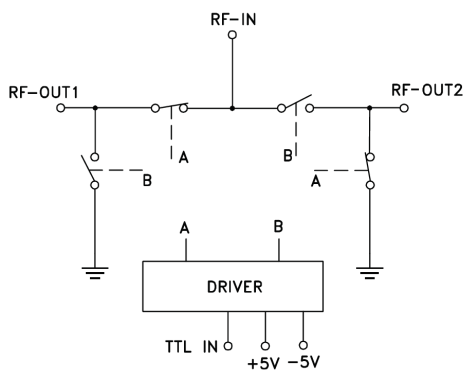

Pad#	Function
1	RF IN
3	V _{EE} (-5V)
4	RF OUT 1
6	TTL
7	TTL GROUND
9	RF OUT 2
10	V _{DD} (+5V)
2,5,8,11 & Bottom of Die	GROUND

Bonding Pad Position

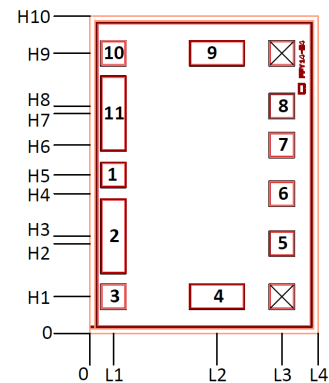

Dimensions in μm, Typical

L1	L2	L3	L4	H1	H2	H3	H4	H5	H6	H7	H8	H9	H10
76	408	617	733	119	290	314	450	511	607	709	733	903	1022

Thickness	Die size	Pad Size 1,3,5,6,7,8 & 10	Pad size 2 & 11	Pad size 4&9
100	733 x 1022	74 x 74	74 x 234	169 x 74



RF Electrical Specifications¹, T_{AMB}=25°C, 50Ω, V_{DD}= +5V, V_{EE}= -5V

Parameter	Condition (MHz)	Min.	Typ.	Max.	Units
Frequency range ³		DC		6000	MHz
Insertion loss	10 - 100		0.4		dB
	100 - 1000		0.5		
	1000 - 2000		0.6		
	2000 - 4500		0.8		
	4500 - 6000		1.3		
Isolation between Output Port 1 & 2	10 - 100		78		dB
	100 - 1000		63		
	1000 - 2000		55		
	2000 - 4000		46		
	4000 - 4500		37		
Isolation between Common Port & Output Ports	10 - 100		88		dB
	100 - 1000		77		
	1000 - 2000		56		
	2000 - 4000		42		
	4000 - 4500		32		
Input Return loss	10 - 100		30		dB
	100 - 1000		30		
	1000 - 2000		29		
	2000 - 4000		28		
	4000 - 4500		15		
Output Return loss (Both ON STATE & OFF STATE)	10 - 100		30		dB
	100 - 1000		30		
	1000 - 2000		29		
	2000 - 4000		28		
	4000 - 4500		15		
Input Power at P1dB ²	10 - 100		16.7		dBm
	100 - 1000		24.4		
	1000 - 2000		26.2		
	2000 - 4000		25.6		
	4000 - 4500		25.6		
Input IP3 (Pout=0 dBm/Tone)	10 - 100		38.4		dBm
	100 - 1000		44.5		
	1000 - 2000		46.3		
	2000 - 4000		45.7		
	4000 - 4500		43.8		
Thermal Resistance - Junction-to-ground lead at 85°C stage temperature			34.2		°C/W

DC Electrical Specifications

Parameter	Min.	Typ.	Max.	Units
Positive Supply Voltage, V _{DD}	4.75	5	5.25	V
Negative Supply voltage, V _{EE}	-5.25	-5	-4.75	V
Positive Supply Current, I _{DD}	—	4	9	mA
Negative Supply Current, I _{EE}	—	3	9	mA
Control Voltage Low	—	0	0.8	V
Control Voltage High	2.3	—	5	V
Control Current Low	—	2	200	μA
Control Current High	—	0.4	5	mA

1. Die is packaged in 3x3mm 12L MCLP and Tested on Mini-Circuits' test board TB-M3SWA263DRC+ (See Fig.1)

2. Input Power at P1dB compression drops to 11 dB at 10 MHz.

3. All RF-ports must be DC blocked or held at 0V DC.

Switching Specifications

Parameter	Condition	Min.	Typ.	Max.	Units	
ON Time, 50% control to 90%	RF Pin= 0 dBm RF Freq.= 500 MHz Control Freq.= 500 KHz Control High= 2.3V Control Low= 0V		9.3		ns	
OFF Time, 50% control to 10%			8.5		ns	
Video Leakage			25		mV	
Rise Time, 10% RF to 90% RF				5.6		ns
Fall Time, 90% RF to 10% RF				6.0		ns
Gate Lag, ON & OFF				7.4		ns



Absolute Maximum Ratings⁴

Parameter	Ratings
Operating temperature	-55°C to +100°C
RF Power Max at Input Port	27 dBm
RF Power Max at Output Port (for each port)	24 dBm
Junction Temperature	150°C
Total Power Dissipation	0.4W
DC Voltage on V _{DD}	+6V
DC Voltage on V _{EE}	-6V

4. Permanent damage may occur if any of these limits are exceeded. Electrical Maximum ratings are not intended for continuous normal operation.

Truth Table

State of Control Voltage	RF-IN to RF-OUT 1	RF-IN to RF-OUT 2
LOW	ON	OFF
HIGH	OFF	ON

Characterization & Application Circuit

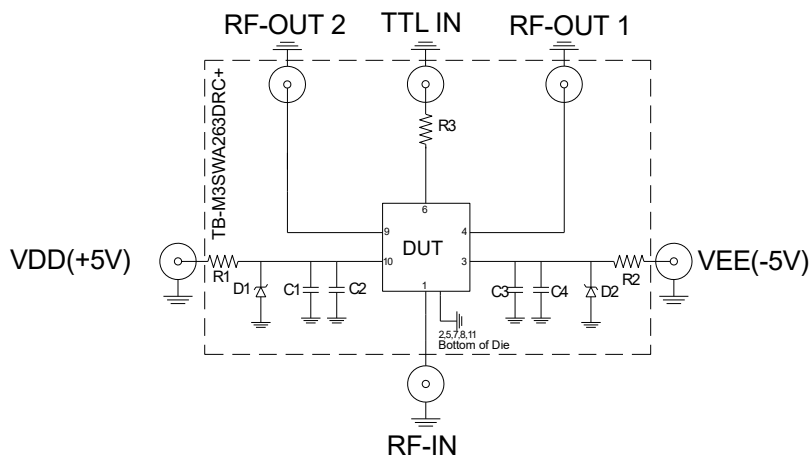

Note: D1&D2 are optional.

Figure 1. Characterization & Application Circuit

Note: (DUT is packaged in 3x3mm 12L MCLP and soldered on Mini-Circuits Characterization & Application Test Board TB-M3SWA263DRC+). Insertion Loss, Amplitude Unbalance, Isolation, Return Loss, Input Power at 1dB Compression (P1dB) & Input IP3 tested using E5071C microwave network analyzer.

Condition:

1. Insertion Loss, Amplitude Unbalance, Isolation & Return Loss: Pin = 0dBm
2. Input IP3 (IIP3): Two tones, spaced 1 MHz apart, 0dBm/tone output.

Assembly Diagram

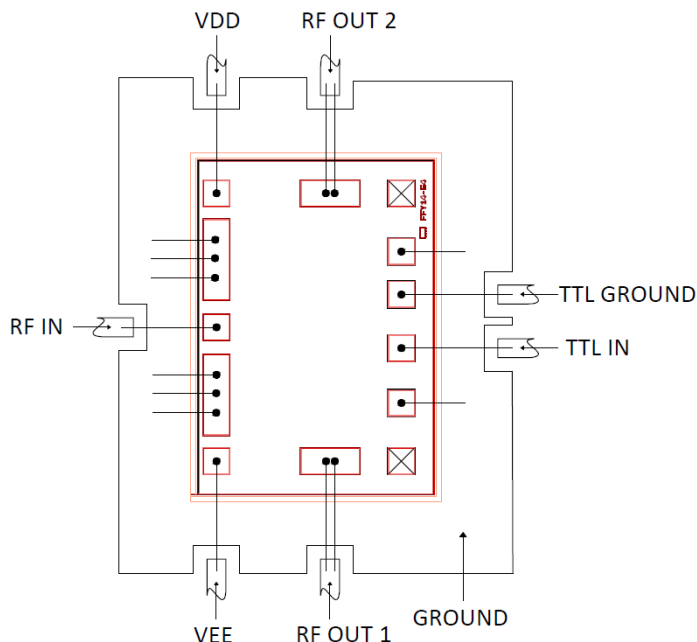

Assembly and Handling Procedure

1. Storage

Dice should be stored in a dry nitrogen purged desiccators or equivalent.

2. ESD

MMIC SPDT Absorptive Switch dice are susceptible to electrostatic and mechanical damage. Dice are supplied in antistatic protected material, which should be opened in clean room conditions at an appropriately grounded anti-static workstation. Devices need careful handling using correctly designed collets, vacuum pickup tips or sharp antistatic tweezers to deter ESD damage to dice.

3. Die Attach

The die mounting surface must be clean and flat. Using conductive silver filled epoxy, recommended epoxies are DieMat DM6030HK-PT/H579 or Ablestik 84-1LMISR4. Apply sufficient epoxy to meet required epoxy bond line thickness, epoxy fillet height and epoxy coverage around total die periphery. Parts shall be cured in a nitrogen filled atmosphere per manufacturer's cure condition. It is recommended to use antistatic die pick up tools only.

4. Wire Bonding

Bond pad openings in the surface passivation above the bond pads are provided to allow wire bonding to the dice gold bond pads. Thermosonic bonding is used with minimized ultrasonic content. Bond force, time, ultrasonic power and temperature are all critical parameters. Suggested wire is pure gold, 1 mil diameter. Bonds must be made from the bond pads on the die to the package or substrate. All bond wires should be kept as short as low as reasonable to minimize performance degradation due to undesirable series inductance.

Additional Detailed Technical Information*additional information is available on our dash board.*

Performance Data	Data Table	
	Swept Graphs	
	S-Parameter (S2P Files) Data Set with and without port extension(.zip file)	
Case Style	Die	
Die Ordering and packaging information	Quantity, Package Small, Gel - Pak: 5,10,50,100 KGD* Medium†, Partial wafer: KGD*<1748 Large†, Full Wafer	Model No. M3SWA263DRC-DG+ M3SWA263DRC-DP+ M3SWA263DRC-DF+
	†Available upon request contact sales representative Refer to AN-60-067	
Environmental Ratings	ENV80	

*Known Good Dice ("KGD") means that the dice in question have been subjected to Mini-Circuits DC test performance criteria and measurement instructions and that the parametric data of such dice fall within a predefined range. While DC testing is not definitive, it does help to provide a higher degree of confidence that dice are capable of meeting typical RF electrical parameters specified by Mini-Circuits.

ESD Rating**

Human Body Model (HBM): Class 1A (Pass 250V) in accordance with ANSI/ESD STM 5.1 - 2001

** Tested in industry standard MCLP 3x3 mm, 12-lead package.

Additional Notes

- A. Performance and quality attributes and conditions not expressly stated in this specification document are intended to be excluded and do not form a part of this specification document.
- B. Electrical specifications and performance data contained in this specification document are based on Mini-Circuit's applicable established test performance criteria and measurement instructions.
- C. The parts covered by this specification document are subject to Mini-Circuits standard limited warranty and terms and conditions (collectively, "Standard Terms"); Purchasers of this part are entitled to the rights and benefits contained therein. For a full statement of the Standard Terms and the exclusive rights and remedies thereunder, please visit Mini-Circuits' website at www.minicircuits.com/MCLStore/terms.jsp
- D. Mini-Circuits does not warrant the accuracy or completeness of the information, text, graphic and other items contained within this document and same are provided as an accommodation and on an "As is" basis with all faults.
- E. Purchaser of this part solely responsible for proper storing, handling, assembly and processing of Known Good Dice (including, without limitation, proper ESD preventive measures, die preparation, die attachment, wire bonding and related assembly and test activities), and Mini-Circuits assumes no responsibility for environmental effects on Known Good Dice.
- F. Mini-Circuits and the Mini-Circuits logo are registered trademarks of Scientific Components Corporation d/b/a Mini-Circuits. All other third-party trademarks are the property of their respective owners. A reference to any third-party trademark does not constitute or imply any endorsement, affiliation, sponsorship, or recommendation by any such third-party of Mini-Circuits or its products.

Typical Performance Data

FREQ (MHz)	INSERTION LOSS @ VDD=+4.75V, VEE =-4.75V OVER TEMPERATURE						FREQ (MHz)	ISOLATION @ VDD=+4.75V, VEE =-4.75V OVER TEMPERATURE											
	RF COM-RF1 (dB) STATE 2*			RF COM-RF2 (dB) STATE 1*				RF COM-RF1 (dB) STATE 1*			RF COM-RF2 (dB) STATE 2*			RF1-RF2 (dB) STATE 2*			RF1-RF2 (dB) STATE 1*		
	-55°C	+25°C	+100°C	-55°C	+25°C	+100°C		-55°C	+25°C	+100°C	-55°C	+25°C	+100°C	-55°C	+25°C	+100°C	-55°C	+25°C	+100°C
	10	0.45	0.38	0.38	0.46	0.37		0.38	10	84.85	80.89	93.64	72.71	74.57	74.21	70.46	74.44	69.86	74.95
20	0.50	0.41	0.41	0.50	0.40	0.40	20	90.14	86.82	84.45	82.68	82.07	80.58	82.33	81.87	86.19	84.25	93.85	87.85
30	0.51	0.42	0.42	0.52	0.41	0.41	30	85.33	84.71	89.89	81.56	80.79	87.02	88.97	85.37	92.70	82.80	94.95	94.33
40	0.53	0.43	0.43	0.53	0.42	0.42	40	79.47	77.46	83.93	80.04	79.01	77.47	82.02	90.10	90.24	88.01	86.46	97.91
50	0.53	0.44	0.43	0.54	0.43	0.42	50	78.86	80.15	81.35	77.30	80.88	80.67	83.03	92.20	92.62	85.35	84.42	95.74
60	0.53	0.44	0.43	0.54	0.43	0.42	60	76.79	77.49	78.48	74.82	77.38	76.50	82.79	85.10	85.33	87.76	85.09	99.20
70	0.54	0.44	0.43	0.55	0.44	0.42	70	74.64	76.94	77.00	74.00	75.85	76.89	79.47	90.10	94.78	81.74	91.46	97.02
80	0.54	0.44	0.43	0.55	0.44	0.42	80	74.62	75.41	77.73	72.58	74.57	76.25	79.90	87.24	93.17	80.29	85.89	90.22
90	0.54	0.45	0.43	0.55	0.44	0.42	90	72.74	74.26	75.90	72.34	75.03	73.63	78.52	86.32	96.90	84.10	83.95	94.77
100	0.54	0.45	0.44	0.55	0.44	0.42	100	72.00	72.92	74.35	71.18	73.00	75.58	78.92	86.52	91.63	81.25	87.97	93.79
500	0.58	0.50	0.49	0.58	0.48	0.45	500	61.78	62.67	63.14	61.00	62.39	63.13	75.26	89.96	76.79	80.70	79.12	74.18
1000	0.61	0.54	0.54	0.60	0.52	0.49	1000	56.06	58.13	58.27	56.62	58.00	58.24	65.12	64.42	62.52	61.84	63.04	61.57
1500	0.65	0.58	0.59	0.62	0.55	0.52	1500	53.26	54.59	54.52	53.32	54.62	54.44	56.18	56.59	55.44	55.27	56.37	55.37
2000	0.68	0.62	0.63	0.64	0.58	0.55	2000	50.15	52.33	52.05	50.10	52.26	51.93	50.05	51.07	50.18	49.46	50.82	50.06
2500	0.72	0.67	0.68	0.66	0.61	0.58	2500	46.95	50.08	49.59	47.06	50.05	49.52	45.50	46.68	45.93	45.04	46.53	45.86
3000	0.76	0.71	0.73	0.68	0.65	0.62	3000	43.73	47.57	46.94	44.08	47.48	46.76	41.93	43.22	42.49	41.51	43.08	42.44
3500	0.82	0.77	0.80	0.73	0.69	0.67	3500	40.83	44.83	44.09	41.43	44.86	44.02	39.01	40.30	39.59	38.59	40.14	39.49
4000	0.92	0.87	0.92	0.83	0.76	0.75	4000	38.40	42.09	41.21	39.00	42.18	41.24	36.48	37.68	36.95	36.03	37.51	36.84
4500	1.05	1.02	1.09	0.94	0.87	0.88	4500	36.59	39.46	38.56	36.90	39.80	38.82	34.26	35.29	34.59	33.89	35.18	34.51
5000	1.17	1.16	1.28	1.04	1.00	1.05	5000	35.19	37.46	36.57	35.19	37.88	36.94	32.29	33.17	32.51	31.84	32.96	32.33
5500	1.28	1.30	1.43	1.10	1.12	1.18	5500	33.57	35.34	34.52	33.67	36.21	35.29	30.41	31.15	30.53	29.80	30.81	30.23
6000	1.41	1.43	1.56	1.20	1.26	1.32	6000	32.09	33.84	33.07	32.83	34.85	33.89	28.36	28.94	28.36	27.65	28.49	27.93

STATE	TTL-IN	RF Com to RF1	RF Com to RF2
1	High	OFF	ON
2	Low	ON	OFF

Note: Test data of Die packaged in industry standard, 3x3mm, 12-lead MCLP package



Typical Performance Data

FREQ (MHz)	RETURN LOSS @ Vdd=+4.75V OVER TEMPERATURE																	
	RF COM (dB) STATE 2*			RF COM (dB) STATE 1*			RF1 (dB) STATE 2*			RF1 (dB) STATE 1*			RF2 (dB) STATE 2*			RF2 (dB) STATE 1*		
	-55°C	+25°C	+100°C	-55°C	+25°C	+100°C	-55°C	+25°C	+100°C	-55°C	+25°C	+100°C	-55°C	+25°C	+100°C	-55°C	+25°C	+100°C
	10	26.89	29.10	28.72	26.61	28.97	28.73	27.08	29.39	28.88	23.90	52.58	43.76	22.48	52.54	43.17	26.81	29.31
20	27.32	29.36	29.20	26.96	29.47	29.43	27.54	29.66	29.56	24.16	50.20	42.95	22.83	49.68	42.25	26.94	29.62	29.62
30	27.79	29.94	29.57	27.42	29.98	29.78	27.79	29.96	29.60	24.47	47.26	41.77	23.17	46.87	40.83	27.54	29.97	29.76
40	28.05	30.33	29.77	27.72	30.30	29.97	27.98	30.21	29.64	24.89	45.41	40.87	23.58	45.09	39.92	27.82	30.24	29.87
50	28.11	30.44	29.73	27.76	30.26	29.86	28.03	30.28	29.58	25.32	44.15	40.17	24.05	43.93	39.28	27.80	30.33	29.81
60	28.17	30.52	29.71	27.88	30.33	29.91	28.11	30.39	29.60	25.67	43.26	39.62	24.47	42.85	38.73	27.85	30.44	29.83
70	28.23	30.55	29.72	28.00	30.41	30.01	28.21	30.49	29.66	25.94	42.47	39.21	24.83	42.20	38.35	27.94	30.54	29.87
80	28.27	30.55	29.73	28.09	30.49	30.12	28.31	30.58	29.75	26.15	42.00	38.90	25.11	41.79	38.14	27.94	30.60	29.92
90	28.31	30.55	29.74	28.27	30.63	30.29	28.42	30.67	29.85	26.36	41.53	38.58	25.36	41.48	37.93	27.87	30.61	29.93
100	28.34	30.52	29.74	28.37	30.68	30.37	28.43	30.64	29.83	26.50	41.13	38.33	25.57	41.28	37.83	27.74	30.53	29.85
500	28.06	29.94	28.86	28.16	30.26	28.97	28.64	30.71	29.94	26.98	40.22	37.33	25.93	43.55	40.78	26.38	30.51	29.25
1000	27.77	29.12	28.10	28.38	28.84	27.77	28.46	30.19	29.18	25.90	39.21	36.78	27.47	38.56	35.23	25.67	30.71	30.08
1500	27.78	29.08	27.80	30.57	29.18	27.65	29.36	30.96	29.88	25.10	38.88	36.04	26.31	37.81	33.97	25.74	30.56	29.47
2000	29.12	30.70	28.85	31.03	30.45	28.90	30.49	32.05	30.56	25.25	38.51	35.34	25.56	42.52	36.78	26.15	31.65	29.41
2500	31.59	33.14	30.67	29.33	32.96	29.97	30.71	32.52	30.90	27.07	36.55	33.95	28.55	35.61	33.18	30.32	33.11	31.32
3000	31.71	31.75	29.62	28.13	32.46	30.37	32.17	33.22	31.12	30.26	30.31	29.35	29.27	30.71	29.42	49.73	30.92	28.61
3500	24.58	25.21	24.33	22.61	26.32	25.90	27.46	27.77	26.51	27.04	25.23	24.61	29.11	27.35	27.07	26.63	28.11	26.39
4000	19.14	19.53	18.75	17.62	20.34	19.61	20.63	20.79	19.90	21.45	21.37	20.72	23.52	21.89	21.30	18.23	21.20	20.53
4500	15.74	15.61	14.66	14.92	16.49	15.43	17.26	16.75	15.80	18.16	18.71	17.95	20.42	20.08	18.87	15.01	17.38	16.13
5000	14.44	13.88	12.79	14.07	14.35	13.18	15.82	14.82	13.75	16.46	16.99	16.18	18.71	18.19	16.99	14.63	15.40	14.01
5500	13.91	13.10	12.11	14.29	13.55	12.43	15.06	13.87	12.93	15.47	15.89	15.11	16.70	16.28	15.31	15.10	13.81	12.70
6000	13.11	12.49	11.91	13.44	12.43	11.80	14.50	13.55	12.98	14.52	15.23	14.63	14.68	14.82	13.97	15.35	12.88	12.12

*Note:

STATE	TTL-IN	RF Com to RF1	RF Com to RF2
1	High	OFF	ON
2	Low	ON	OFF

Note: Test data of Die packaged in industry standard, 3x3mm, 12-lead MCLP package



Typical Performance Data

FREQ (MHz)	INSERTION LOSS @ VDD=+4.75V, VEE =-4.75V OVER TEMPERATURE						FREQ (MHz)	ISOLATION @ VDD=+5V, VEE =-5V OVER TEMPERATURE											
	RF COM-RF1 (dB)			RF COM-RF2 (dB)				RF COM-RF1 (dB)			RF COM-RF2 (dB)			RF1-RF2 (dB)			RF1-RF2 (dB)		
	STATE 2*			STATE 1*				STATE 1*			STATE 2*			STATE 2*			STATE 1*		
	-55°C	+25°C	+100°C	-55°C	+25°C	+100°C		-55°C	+25°C	+100°C	-55°C	+25°C	+100°C	-55°C	+25°C	+100°C	-55°C	+25°C	+100°C
10	0.45	0.38	0.38	0.47	0.37	0.38	10	87.16	86.55	87.77	74.56	72.62	78.76	69.72	71.60	74.06	70.07	69.68	73.31
20	0.50	0.41	0.41	0.51	0.40	0.40	20	80.21	92.15	81.08	84.42	81.00	94.33	80.11	80.16	83.76	80.87	96.15	85.04
30	0.51	0.42	0.42	0.53	0.41	0.41	30	83.36	84.15	81.52	82.81	82.82	87.38	84.46	86.70	90.06	86.67	96.85	92.20
40	0.52	0.43	0.43	0.54	0.42	0.42	40	79.74	80.45	86.38	82.32	78.60	87.11	85.25	88.19	88.28	85.14	86.97	91.22
50	0.53	0.44	0.43	0.54	0.43	0.42	50	78.32	79.40	79.79	77.80	78.83	78.53	83.64	90.11	87.81	82.38	97.35	89.24
60	0.53	0.44	0.43	0.55	0.43	0.42	60	76.33	77.84	76.78	75.46	79.60	79.80	80.57	87.51	96.37	87.80	85.93	97.99
70	0.54	0.44	0.43	0.55	0.44	0.42	70	75.35	77.80	76.44	76.19	76.56	78.66	80.44	91.41	99.19	83.32	97.63	90.18
80	0.54	0.44	0.43	0.55	0.44	0.42	80	74.67	74.89	77.97	72.25	75.55	76.08	82.37	82.84	95.87	81.29	95.33	111.43
90	0.54	0.45	0.44	0.55	0.44	0.42	90	73.98	73.89	76.18	72.41	74.80	76.53	81.90	90.78	93.94	81.70	95.39	99.50
100	0.54	0.45	0.44	0.56	0.44	0.42	100	72.40	75.22	75.71	71.50	74.49	75.45	81.10	90.15	104.58	80.68	92.37	105.58
500	0.58	0.50	0.49	0.58	0.49	0.46	500	62.23	62.65	63.32	61.06	62.71	63.28	76.25	82.94	76.34	78.62	76.63	73.72
1000	0.61	0.54	0.54	0.60	0.52	0.49	1000	56.15	58.15	58.32	56.77	58.09	58.20	65.99	64.11	62.37	60.86	62.55	61.56
1500	0.64	0.58	0.59	0.62	0.56	0.52	1500	52.91	54.61	54.42	53.76	54.59	54.41	56.99	56.52	55.44	54.63	56.25	55.29
2000	0.68	0.63	0.64	0.64	0.59	0.55	2000	49.77	52.31	52.10	50.79	52.31	51.93	50.75	51.09	50.18	49.04	50.80	50.06
2500	0.72	0.67	0.69	0.66	0.62	0.58	2500	46.53	50.20	49.63	48.05	50.18	49.61	46.22	46.79	45.98	44.73	46.60	45.91
3000	0.76	0.71	0.74	0.68	0.65	0.62	3000	43.34	47.64	46.95	45.16	47.61	46.80	42.62	43.31	42.54	41.23	43.13	42.46
3500	0.81	0.77	0.81	0.72	0.70	0.67	3500	40.44	44.97	44.13	42.57	45.08	44.09	39.75	40.44	39.64	38.37	40.23	39.50
4000	0.90	0.87	0.93	0.83	0.77	0.75	4000	38.02	42.24	41.30	40.12	42.39	41.34	37.16	37.81	37.02	35.80	37.58	36.89
4500	1.03	1.01	1.10	0.94	0.88	0.89	4500	36.20	39.59	38.62	38.03	39.99	38.94	34.94	35.44	34.65	33.66	35.29	34.55
5000	1.15	1.16	1.28	1.04	1.00	1.05	5000	34.83	37.59	36.63	36.39	38.12	37.04	32.88	33.32	32.59	31.62	33.06	32.38
5500	1.25	1.30	1.43	1.10	1.12	1.18	5500	33.20	35.48	34.58	34.86	36.41	35.40	31.00	31.30	30.60	29.59	30.89	30.28
6000	1.38	1.42	1.55	1.20	1.26	1.31	6000	31.72	33.94	33.14	33.79	35.12	34.00	28.96	29.11	28.44	27.47	28.59	27.97

STATE	TTL-IN	RF Com to RF1	RF Com to RF2
1	High	OFF	ON
2	Low	ON	OFF

Note: Test data of Die packaged in industry standard, 3x3mm, 12-lead MCLP package



Typical Performance Data

FREQ (MHz)	RETURN LOSS @ Vdd=+5V OVER TEMPERATURE																	
	RF COM (dB) STATE 2*			RF COM (dB) STATE 1*			RF1 (dB) STATE 2*			RF1 (dB) STATE 1*			RF2 (dB) STATE 2*			RF2 (dB) STATE 1*		
	-55°C	+25°C	+100°C	-55°C	+25°C	+100°C	-55°C	+25°C	+100°C	-55°C	+25°C	+100°C	-55°C	+25°C	+100°C	-55°C	+25°C	+100°C
	10	27.02	29.12	28.78	26.45	28.96	28.75	27.22	29.38	28.96	23.59	49.19	43.72	26.92	48.44	43.13	26.64	29.30
20	27.26	29.36	29.06	26.80	29.47	29.37	27.49	29.67	29.42	23.89	47.84	42.87	27.13	47.31	42.08	26.80	29.61	29.54
30	27.78	29.94	29.48	27.23	29.99	29.75	27.77	29.96	29.51	24.24	45.62	41.75	27.38	45.25	40.70	27.36	29.99	29.73
40	28.11	30.33	29.71	27.50	30.29	29.94	28.01	30.22	29.60	24.69	44.10	40.83	27.67	43.84	39.80	27.61	30.25	29.85
50	28.25	30.44	29.73	27.52	30.24	29.87	28.11	30.29	29.60	25.11	43.01	40.12	27.96	42.82	39.11	27.58	30.34	29.82
60	28.34	30.53	29.76	27.62	30.32	29.92	28.25	30.41	29.64	25.47	42.15	39.60	28.22	41.96	38.57	27.64	30.46	29.85
70	28.40	30.57	29.77	27.73	30.40	30.02	28.36	30.52	29.71	25.73	41.55	39.16	28.44	41.36	38.19	27.69	30.56	29.89
80	28.42	30.57	29.76	27.82	30.47	30.12	28.47	30.62	29.79	25.95	41.09	38.85	28.60	40.97	37.95	27.69	30.62	29.93
90	28.43	30.56	29.76	27.99	30.61	30.29	28.56	30.69	29.85	26.13	40.68	38.54	28.74	40.68	37.80	27.62	30.63	29.94
100	28.42	30.53	29.74	28.09	30.65	30.37	28.55	30.64	29.82	26.26	40.36	38.30	28.83	40.53	37.70	27.52	30.53	29.85
500	28.18	29.95	28.82	28.01	30.27	28.96	28.84	30.78	29.97	26.70	39.66	37.36	28.51	40.94	40.79	26.09	30.65	29.27
1000	27.94	29.19	28.00	28.08	28.92	27.77	28.44	30.26	29.28	25.66	38.96	36.83	30.57	38.77	35.34	25.46	30.68	30.13
1500	27.86	29.17	27.82	30.21	29.24	27.69	29.64	31.00	30.07	24.88	38.80	36.21	28.95	38.61	34.21	25.59	30.69	29.58
2000	29.25	30.79	29.06	30.75	30.52	28.96	30.45	32.22	30.75	24.96	38.54	35.58	28.00	41.87	37.32	26.02	31.82	29.50
2500	31.99	33.36	31.15	29.22	33.22	30.19	30.24	32.60	30.86	26.76	36.44	34.14	32.04	35.74	33.31	30.22	33.07	31.40
3000	31.92	32.12	30.06	27.78	32.74	30.63	32.62	33.45	31.00	29.79	30.26	29.39	31.87	30.95	29.41	46.87	31.12	28.63
3500	24.84	25.45	24.34	22.40	26.51	25.98	27.47	28.02	26.39	26.79	25.23	24.64	30.06	27.11	27.00	26.51	28.28	26.38
4000	19.44	19.64	18.67	17.49	20.44	19.62	20.92	20.91	19.83	21.27	21.40	20.74	23.48	22.09	21.31	18.11	21.31	20.55
4500	15.90	15.70	14.62	14.78	16.57	15.44	17.39	16.83	15.77	18.03	18.74	17.99	20.58	20.25	18.93	14.91	17.48	16.15
5000	14.62	13.96	12.79	13.98	14.42	13.20	15.98	14.90	13.76	16.35	17.05	16.21	18.98	18.28	17.08	14.56	15.46	14.04
5500	14.08	13.20	12.19	14.21	13.62	12.47	15.23	13.96	13.01	15.37	15.96	15.16	16.94	16.44	15.40	15.05	13.88	12.74
6000	13.28	12.59	12.08	13.36	12.50	11.87	14.67	13.63	13.13	14.42	15.30	14.70	14.89	15.02	14.06	15.32	12.96	12.18

*Note:

STATE	TTL-IN	RF Com to RF1	RF Com to RF2
1	High	OFF	ON
2	Low	ON	OFF

Note: Test data of Die packaged in industry standard, 3x3mm, 12-lead MCLP package



Typical Performance Data

FREQ (MHz)	INSERTION LOSS @ VDD=+4.75V, VEE =-4.75V OVER TEMPERATURE						FREQ (MHz)	ISOLATION @ VDD=+5.25V, VEE =-5.25V OVER TEMPERATURE											
	RF COM-RF1 (dB)			RF COM-RF2 (dB)				RF COM-RF1 (dB)			RF COM-RF2 (dB)			RF1-RF2 (dB)			RF1-RF2 (dB)		
	STATE 2*			STATE 1*				STATE 1*			STATE 2*			STATE 2*			STATE 1*		
	-55°C	+25°C	+100°C	-55°C	+25°C	+100°C		-55°C	+25°C	+100°C	-55°C	+25°C	+100°C	-55°C	+25°C	+100°C	-55°C	+25°C	+100°C
10	0.45	0.38	0.39	0.46	0.37	0.38	10	79.84	83.82	96.31	74.48	73.85	73.48	71.28	70.28	71.53	73.17	70.47	69.32
20	0.49	0.41	0.42	0.50	0.40	0.41	20	87.56	85.41	91.92	81.32	81.52	92.37	78.71	81.66	78.10	78.61	91.37	93.01
30	0.51	0.42	0.43	0.52	0.41	0.41	30	80.77	84.50	81.46	83.38	84.16	80.64	82.99	83.35	93.60	82.84	86.12	87.20
40	0.52	0.43	0.43	0.53	0.42	0.42	40	79.04	78.82	82.90	79.98	85.73	81.84	90.84	93.04	92.84	81.59	84.81	86.80
50	0.53	0.44	0.44	0.54	0.43	0.42	50	78.15	78.03	83.28	78.43	80.81	80.94	89.64	101.41	87.18	78.78	93.98	95.12
60	0.53	0.44	0.44	0.54	0.43	0.42	60	76.27	80.78	78.85	76.51	77.86	77.51	83.84	99.69	95.95	80.17	93.01	89.94
70	0.54	0.44	0.44	0.55	0.43	0.43	70	76.20	76.91	77.93	75.16	78.12	78.94	80.68	90.55	101.29	77.66	95.55	93.36
80	0.54	0.44	0.44	0.55	0.43	0.43	80	74.82	75.72	76.75	74.88	75.60	76.29	85.11	87.17	91.24	76.77	89.43	88.29
90	0.54	0.44	0.44	0.55	0.44	0.43	90	74.14	74.87	75.87	73.46	75.04	76.71	83.94	91.95	105.15	75.82	99.75	96.61
100	0.54	0.45	0.44	0.55	0.44	0.43	100	72.32	74.37	75.62	72.48	75.65	75.24	81.26	90.05	94.09	76.22	91.01	101.23
500	0.58	0.50	0.50	0.58	0.48	0.46	500	62.51	62.79	63.25	61.35	62.79	63.41	79.82	80.04	74.96	74.73	75.85	73.36
1000	0.61	0.54	0.55	0.60	0.51	0.50	1000	56.03	58.16	58.39	57.03	57.97	58.13	65.90	63.63	62.20	59.95	62.48	61.43
1500	0.65	0.58	0.60	0.61	0.54	0.53	1500	52.29	54.49	54.48	53.91	54.55	54.40	57.07	56.47	55.42	53.74	56.22	55.26
2000	0.68	0.62	0.65	0.64	0.57	0.56	2000	49.10	52.37	52.08	51.10	52.33	51.95	51.06	51.03	50.18	48.33	50.78	50.03
2500	0.72	0.67	0.69	0.66	0.60	0.59	2500	45.72	50.14	49.68	48.50	50.20	49.59	46.52	46.78	46.02	44.13	46.58	45.91
3000	0.76	0.71	0.74	0.68	0.63	0.63	3000	42.57	47.71	47.02	45.70	47.66	46.83	42.99	43.34	42.57	40.62	43.15	42.48
3500	0.81	0.77	0.81	0.73	0.67	0.67	3500	39.66	44.99	44.15	43.17	45.11	44.13	40.12	40.45	39.68	37.80	40.22	39.55
4000	0.90	0.87	0.93	0.83	0.74	0.76	4000	37.26	42.29	41.33	40.74	42.43	41.38	37.53	37.85	37.05	35.22	37.63	36.93
4500	1.02	1.01	1.10	0.95	0.85	0.89	4500	35.45	39.64	38.70	38.65	40.04	38.98	35.30	35.46	34.69	33.14	35.29	34.60
5000	1.14	1.15	1.29	1.05	0.97	1.05	5000	34.09	37.66	36.73	37.01	38.21	37.10	33.23	33.35	32.63	31.09	33.07	32.42
5500	1.25	1.29	1.44	1.11	1.09	1.17	5500	32.50	35.52	34.67	35.51	36.45	35.45	31.36	31.34	30.64	29.14	30.93	30.29
6000	1.37	1.41	1.55	1.22	1.23	1.30	6000	31.04	34.03	33.17	34.50	35.19	34.07	29.32	29.15	28.47	27.03	28.61	27.98

STATE	TTL-IN	RF Com to RF1	RF Com to RF2
1	High	OFF	ON
2	Low	ON	OFF

Note: Test data of Die packaged in industry standard, 3x3mm, 12-lead MCLP package



Typical Performance Data

FREQ (MHz)	RETURN LOSS @ Vdd=+5.25V OVER TEMPERATURE																	
	RF COM (dB) STATE 2*			RF COM (dB) STATE 1*			RF1 (dB) STATE 2*			RF1 (dB) STATE 1*			RF2 (dB) STATE 2*			RF2 (dB) STATE 1*		
	-55°C	+25°C	+100°C	-55°C	+25°C	+100°C	-55°C	+25°C	+100°C	-55°C	+25°C	+100°C	-55°C	+25°C	+100°C	-55°C	+25°C	+100°C
	10	27.01	29.11	28.80	26.59	28.98	28.75	27.21	29.35	29.03	19.83	48.20	43.56	29.76	47.69	43.23	26.78	29.31
20	27.29	29.39	29.03	26.96	29.50	29.23	27.50	29.71	29.37	20.27	46.88	42.76	29.92	46.54	42.17	26.95	29.65	29.35
30	27.79	29.96	29.45	27.38	30.02	29.65	27.77	29.99	29.47	20.68	44.97	41.53	30.13	44.63	40.82	27.49	30.02	29.60
40	28.11	30.33	29.72	27.66	30.33	29.88	27.99	30.23	29.60	21.27	43.62	40.58	30.38	43.27	39.89	27.74	30.28	29.78
50	28.23	30.45	29.76	27.68	30.29	29.83	28.09	30.29	29.61	21.91	42.68	39.95	30.58	42.31	39.19	27.72	30.34	29.80
60	28.33	30.53	29.78	27.77	30.36	29.89	28.21	30.41	29.67	22.48	41.88	39.40	30.81	41.49	38.64	27.77	30.44	29.87
70	28.39	30.57	29.80	27.88	30.46	29.99	28.32	30.51	29.74	22.84	41.23	39.02	30.96	40.91	38.27	27.83	30.53	29.94
80	28.41	30.57	29.79	27.98	30.55	30.09	28.44	30.60	29.81	23.19	40.83	38.71	31.07	40.56	38.02	27.83	30.60	29.97
90	28.41	30.56	29.78	28.14	30.71	30.24	28.54	30.68	29.87	23.48	40.41	38.42	31.15	40.32	37.88	27.77	30.61	29.97
100	28.41	30.53	29.75	28.24	30.77	30.30	28.53	30.65	29.83	23.68	40.07	38.20	31.20	40.15	37.77	27.64	30.52	29.87
500	28.18	29.99	28.86	28.16	30.25	29.02	28.88	30.78	29.98	24.67	39.43	37.46	30.45	42.30	41.11	26.21	30.39	29.11
1000	27.99	29.22	28.03	28.17	28.91	27.80	28.45	30.30	29.30	23.85	38.86	36.64	32.92	38.00	35.54	25.55	30.95	30.03
1500	27.95	29.25	27.85	30.31	29.33	27.90	29.70	31.13	30.06	23.37	38.88	36.05	30.79	37.81	34.46	25.72	30.60	29.59
2000	29.33	30.94	29.11	31.09	30.63	29.24	30.43	32.21	30.72	23.35	38.73	35.51	29.74	43.37	37.76	26.25	31.61	29.55
2500	31.99	33.48	31.26	29.50	33.12	30.52	30.14	32.58	30.87	24.98	36.45	34.32	34.68	35.49	33.54	30.69	33.38	31.75
3000	32.20	32.30	30.17	27.91	32.95	30.40	32.55	33.56	31.05	27.58	30.19	29.56	33.00	30.66	29.47	46.39	31.11	28.91
3500	25.14	25.57	24.39	22.35	26.61	25.36	27.80	28.20	26.45	26.38	25.20	24.72	30.05	27.35	26.96	26.21	28.30	26.22
4000	19.64	19.75	18.71	17.40	20.51	19.29	21.13	21.01	19.88	21.19	21.42	20.79	23.32	21.93	21.30	17.98	21.36	20.21
4500	16.05	15.76	14.65	14.70	16.61	15.40	17.54	16.91	15.80	17.92	18.78	18.01	20.66	20.19	18.95	14.83	17.43	16.08
5000	14.75	14.01	12.83	13.90	14.45	13.34	16.10	14.96	13.80	16.21	17.08	16.22	19.08	18.35	17.14	14.50	15.48	14.20
5500	14.22	13.25	12.23	14.12	13.65	12.72	15.35	14.00	13.05	15.23	15.98	15.15	17.06	16.43	15.48	15.01	13.87	13.02
6000	13.42	12.64	12.13	13.28	12.51	12.06	14.79	13.68	13.18	14.31	15.33	14.67	14.99	14.95	14.16	15.27	12.92	12.44

*Note:

STATE	TTL-IN	RF Com to RF1	RF Com to RF2
1	High	OFF	ON
2	Low	ON	OFF

Note: Test data of Die packaged in industry standard, 3x3mm, 12-lead MCLP package



Typical Performance Curves

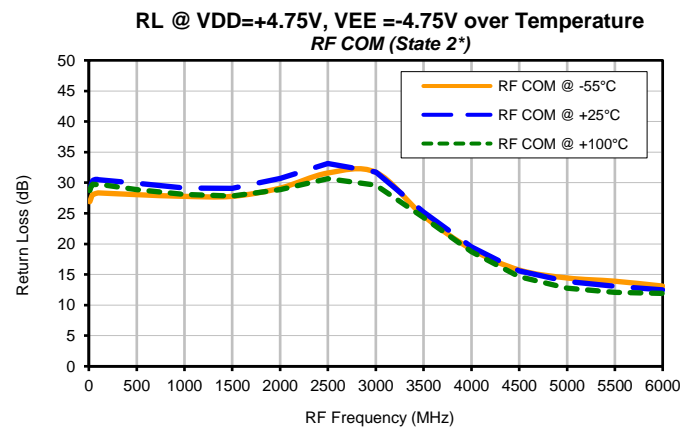
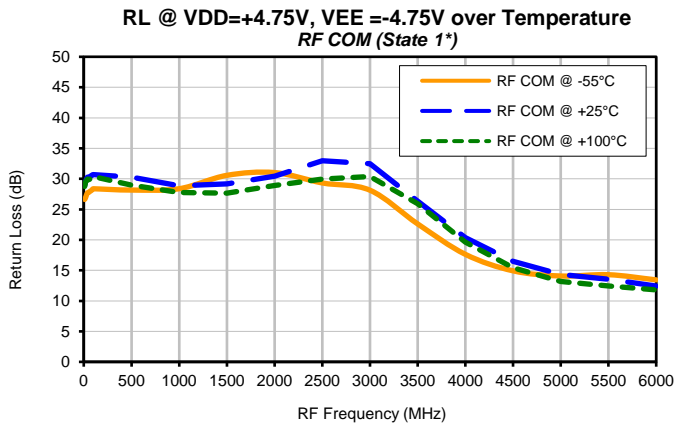
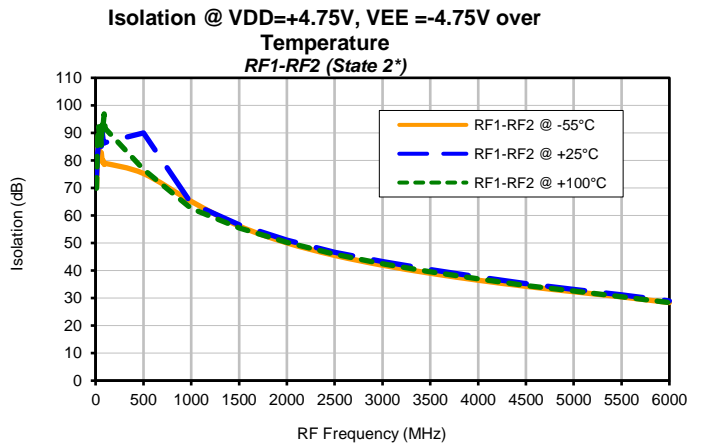
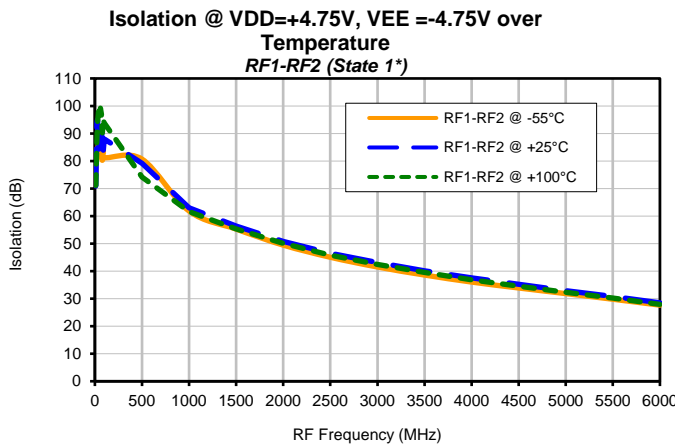
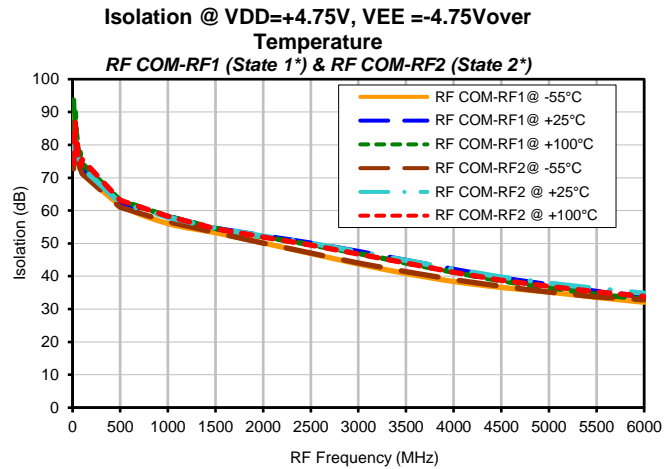
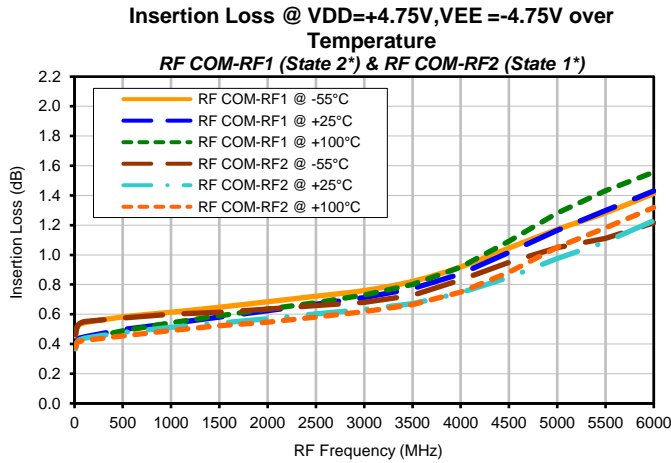

*Note:

STATE	TTL-IN	RF Com to RF1	RF Com to RF2
1	High	OFF	ON
2	Low	ON	OFF

Note: Test data of Die packaged in industry standard, 3x3mm, 12-lead MCLP package

Typical Performance Curves

RL @ VDD=+4.75V, VEE=-4.75V over Temperature
RF1 (State 2*)

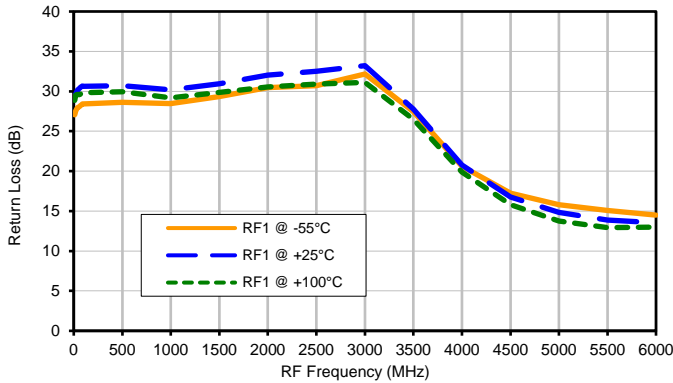

RL @ VDD=+4.75V, VEE=-4.75V over Temperature
RF1 (State 1*)

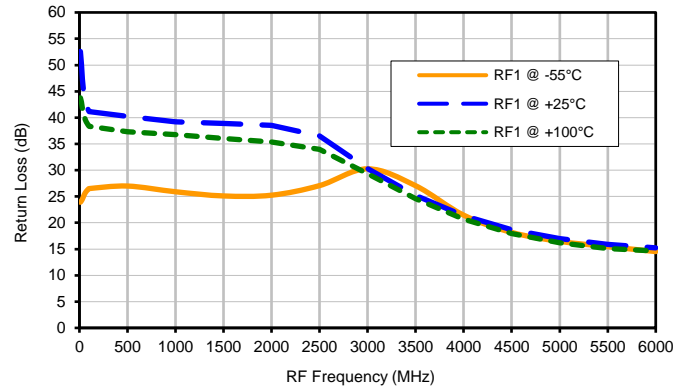

RL @ VDD=+4.75V, VEE=-4.75V over Temperature
RF2 (State 1*)

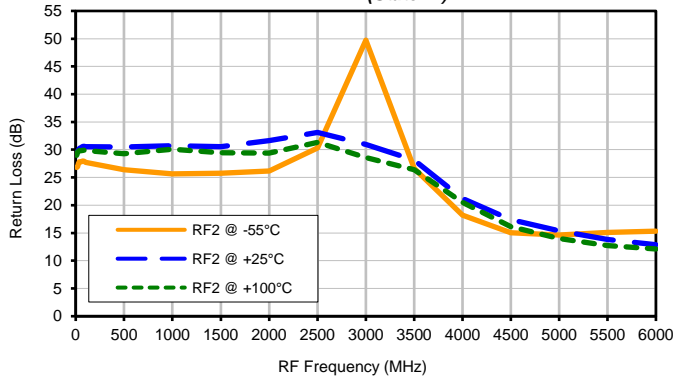

RL @ VDD=+4.75V, VEE=-4.75V over Temperature
RF2 (State 2*)

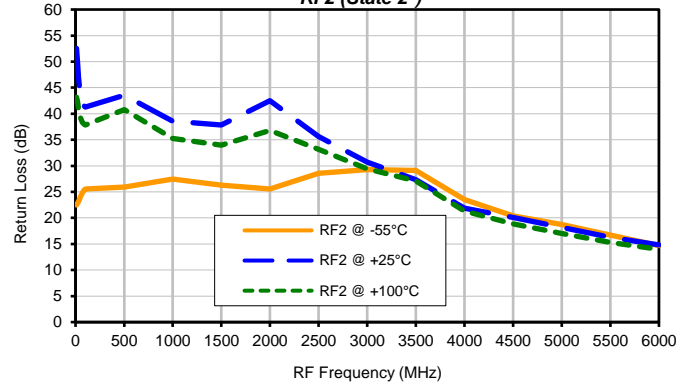

*Note:

STATE	TTL-IN	RF Com to RF1	RF Com to RF2
1	High	OFF	ON
2	Low	ON	OFF

Note: Test data of Die packaged in industry standard, 3x3mm, 12-lead MCLP package

Typical Performance Curves

Insertion Loss @ VDD=+5V, VEE =-5V over Temperature
RF COM-RF1 (State 2*) & RF COM-RF2 (State 1*)

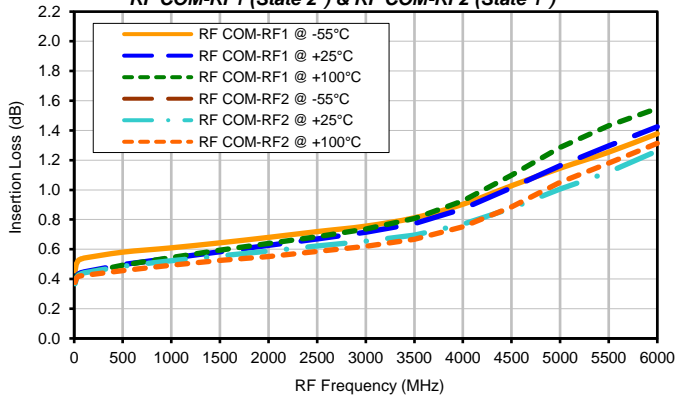

Isolation @ VDD=+5V, VEE =-5V over Temperature
RF COM-RF1 (State 1*) & RF COM-RF2 (State 2*)

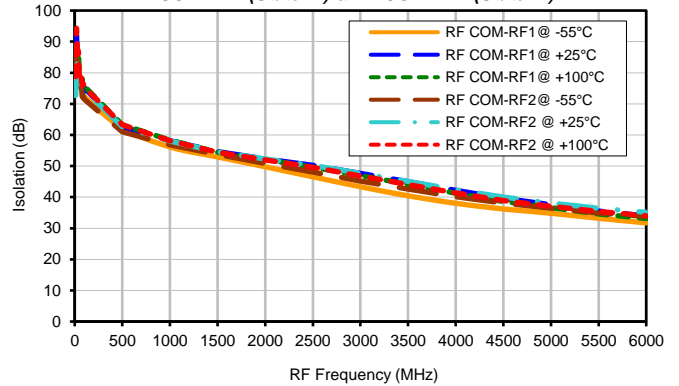

Isolation @ VDD=+5V, VEE =-5V over Temperature
RF1-RF2 (State 1*)

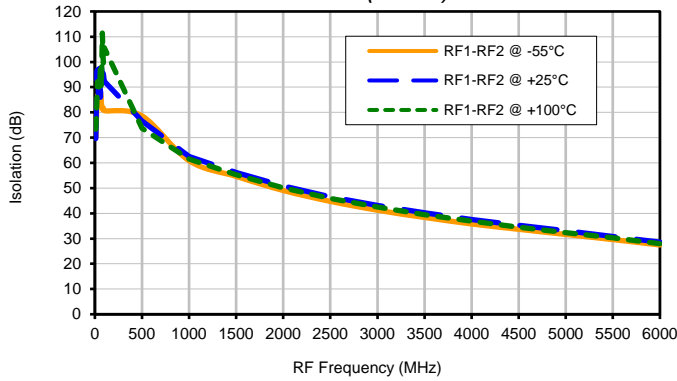

Isolation @ VDD=+5V, VEE =-5V over Temperature
RF1-RF2 (State 2*)

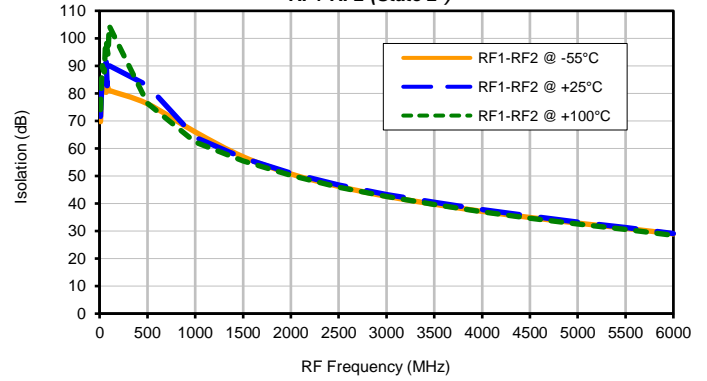

RL @ VDD=+5V, VEE =-5V over Temperature
RF COM (State 1*)

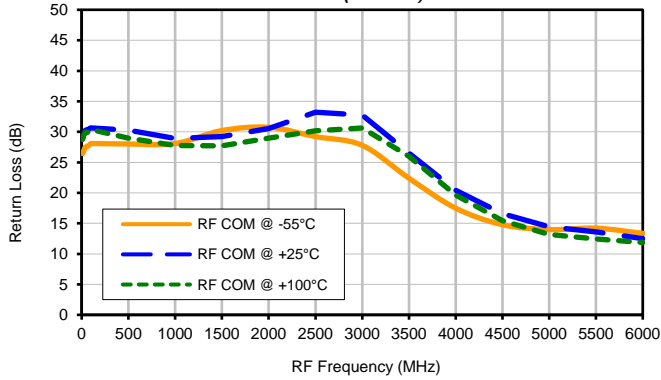

RL @ VDD=+5V, VEE =-5V over Temperature
RF COM (State 2*)

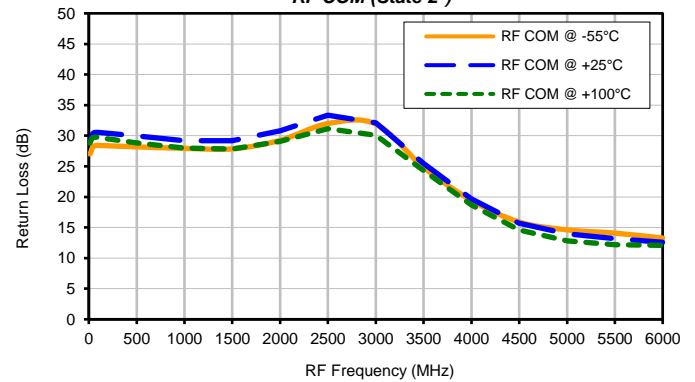

*Note:

STATE	TTL-IN	RF Com to RF1	RF Com to RF2
1	High	OFF	ON
2	Low	ON	OFF

Note: Test data of Die packaged in industry standard, 3x3mm, 12-lead MCLP package



P.O. Box 350166, Brooklyn, New York 11235-0003 (718) 934-4500 • Fax (718) 332-4661 For detailed performance specs & shopping online see Mini-Circuits web site
The Design Engineers Search Engine Provides ACTUAL Data Instantly From MINI-CIRCUITS At: www.minicircuits.com

IF/RF MICROWAVE COMPONENTS

REV. OR
M3SWA263DRC-D+
12/17/2020
Page 3 of 6

Typical Performance Curves

RL @ VDD=+5V, VEE =-5V over Temperature
RF1 (State 2*)

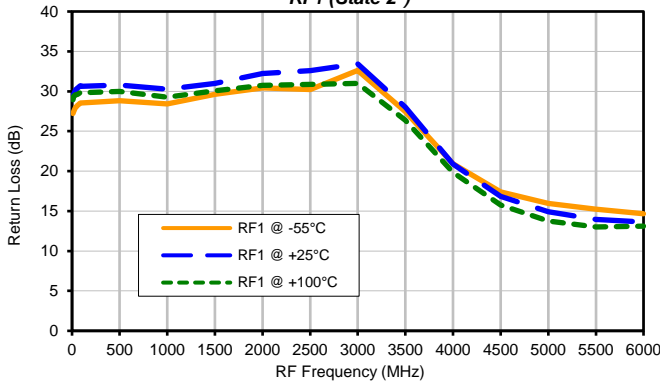

RL @ VDD=+5V, VEE =-5V over Temperature
RF1 (State 1*)

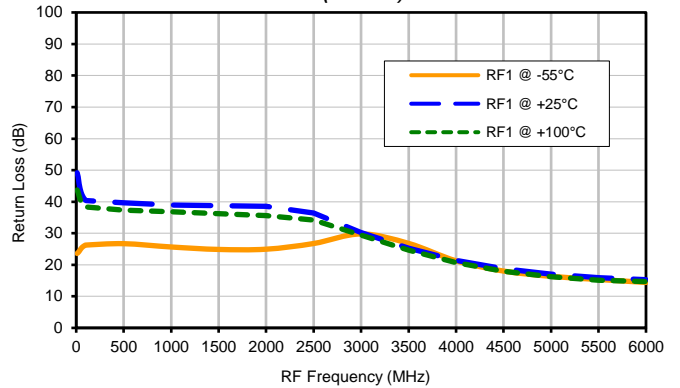

RL @ VDD=+5V, VEE =-5V over Temperature
RF2 (State 1*)

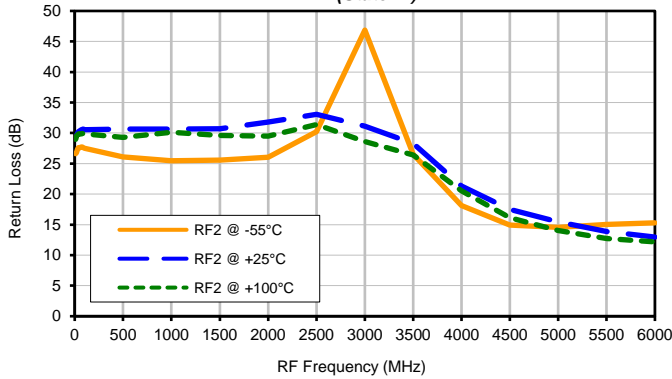

RL @ VDD=+5V, VEE =-5V over Temperature
RF2 (State 2*)

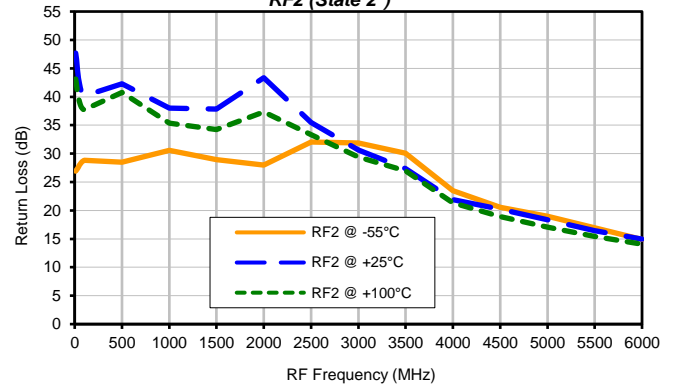

*Note:

STATE	TTL-IN	RF Com to RF1	RF Com to RF2
1	High	OFF	ON
2	Low	ON	OFF

Note: Test data of Die packaged in industry standard, 3x3mm, 12-lead MCLP package

Typical Performance Curves

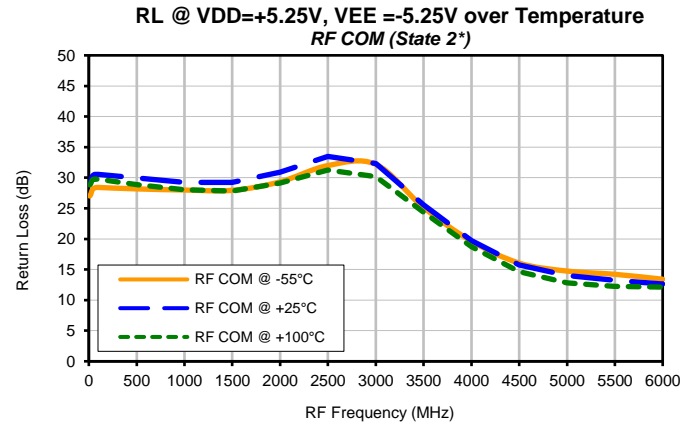
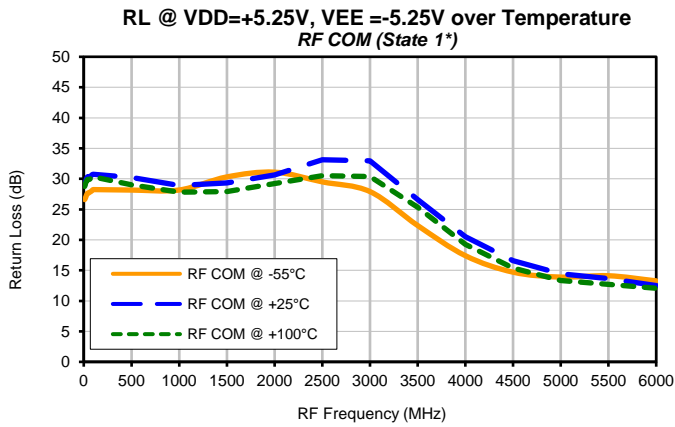
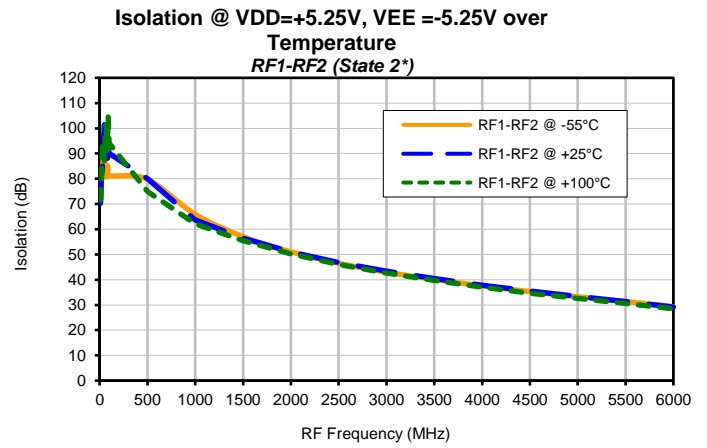
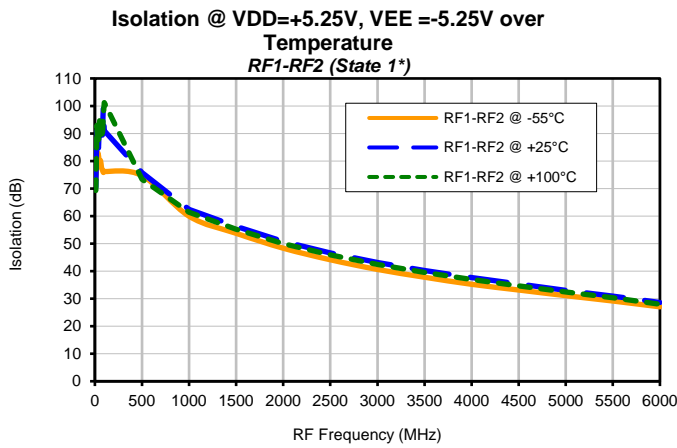
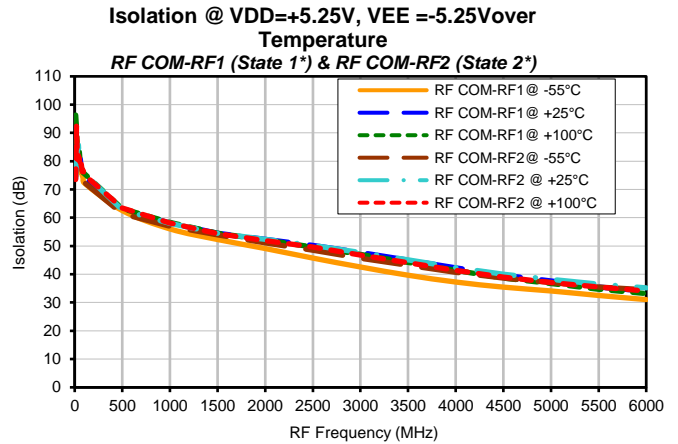
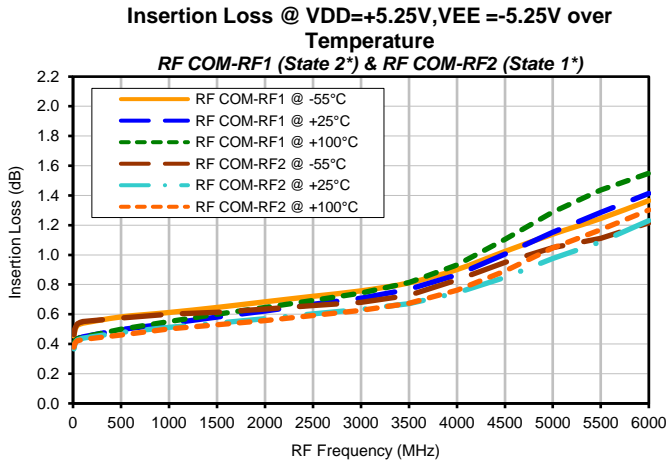

*Note:

STATE	TTL-IN	RF Com to RF1	RF Com to RF2
1	High	OFF	ON
2	Low	ON	OFF

Note: Test data of Die packaged in industry standard, 3x3mm, 12-lead MCLP package

Typical Performance Curves

RL @ VDD=+5.25V, VEE =-5.25V over Temperature
RF1 (State 2*)

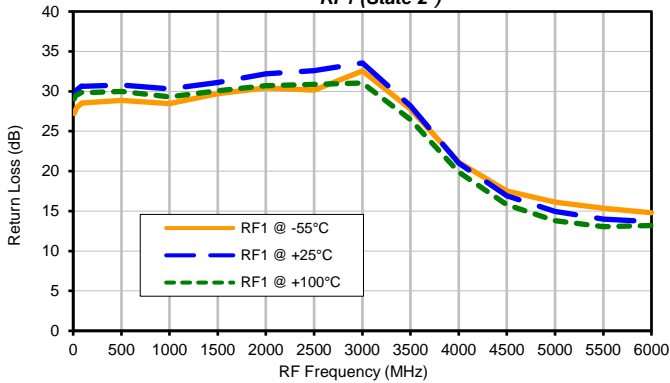

RL @ VDD=+5.25V, VEE =-5.25V over Temperature
RF1 (State 1*)

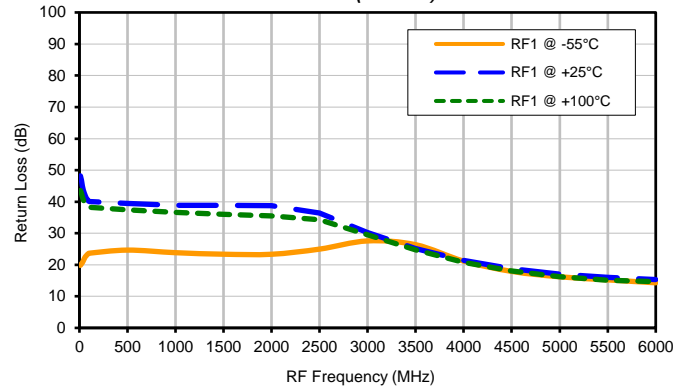

RL @ VDD=+5.25V, VEE =-5.25V over Temperature
RF2 (State 1*)

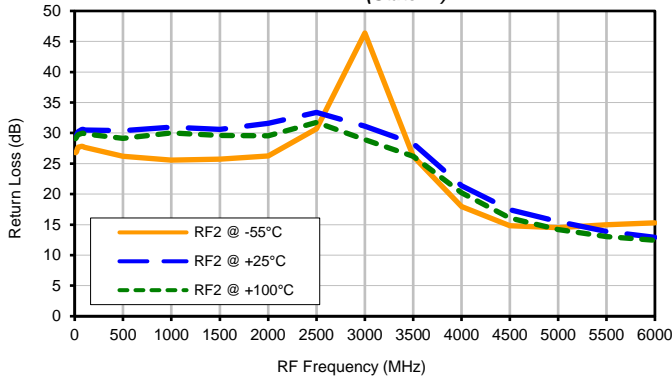

RL @ VDD=+5.25V, VEE =-5.25V over Temperature
RF2 (State 2*)

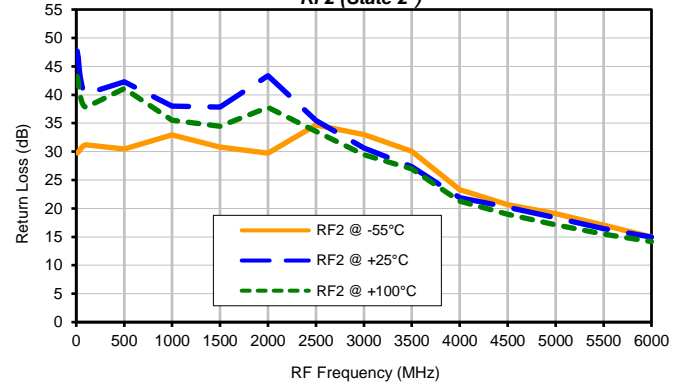

*Note:

STATE	TTL-IN	RF Com to RF1	RF Com to RF2
1	High	OFF	ON
2	Low	ON	OFF

Note: Test data of Die packaged in industry standard, 3x3mm, 12-lead MCLP package



All Mini-Circuits products are manufactured under exacting quality assurance and control standards, and are capable of meeting published specifications after being subjected to any or all of the following physical and environmental test.

Specification	Test/Inspection Condition	Reference/Spec
Operating Temperature	-40° to 85° C or -40° to 105° C or -55° to 105° C Ambient Environment	Refer to Individual Model Data Sheet
Storage Environment	20° to 35° C and 40 to 60% humidity (In Factory Shipped Package)	Individual Model Data Sheet