

ULTRA·REL[®] Ceramic Hermetic Frequency Mixers

MAC Series

300 MHz to 12 GHz LO Levels 4 to 17 dBm

The Big Deal

- 3-Year Guarantee
- Hermetically sealed LTCC construction
- Low-profile case, 0.06" high
- Priced for outstanding VALUE



CASE STYLE: DZ1650

*MIL Screening Available
Please consult Applications Dept.*

Product Overview

Mini-Circuits' MAC mixers employ a unique new design and a highly repeatable, tightly controlled, automated process that delivers industry-leading reliability at a remarkably affordable price. Schottky diode quads meeting our strict specifications are bonded to a multilayer integrated LTCC substrate, and then hermetically sealed under a controlled atmosphere with gold-plated covers and eutectic AuSn solder. These passive, double-balanced mixers are capable of meeting MIL requirements for gross leak, fine leak, thermal shock, vibration, acceleration, mechanical shock, and HTOL (The testing can be done if requested), and every MAC mixer is backed with our 3-year guarantee.

Key Features

Feature	Advantages
Low, Flat Conversion Loss	No need to compensate for variations over frequency.
Hermetically Sealed	Ideal for use anywhere long-term reliability adds bottom-line value: high moisture areas, busy production lines, high-speed distribution centers, heavy industry, outdoor settings, and unmanned facilities, as well as military applications.
Rugged LTCC/Hermetic Construction	Demonstrated reliability in harsh, physically abusive environments with high vibration, acceleration, and/or mechanical shock.
Wide Operating Temperature Range	Guaranteed performance from -55 to +125°C. MAC mixers have also passed thermal shock testing from -55 to +150°C, through 1000 cycles, 15 minutes per cycle.
Exposed Termination Ends	Our unique case design allows for easy visual inspection of side solder fillets per IPC-A-610 section 8.3.4.6, and features gold-plated terminations for excellent solderability.
Incredible Performance/Price	Game-changing affordability brings Hi-Rel hermetic mixers within the reach of commercial budgets.

Notes

- A. Performance and quality attributes and conditions not expressly stated in this specification document are intended to be excluded and do not form a part of this specification document.
 B. Electrical specifications and performance data contained in this specification document are based on Mini-Circuit's applicable established test performance criteria and measurement instructions.
 C. The parts covered by this specification document are subject to Mini-Circuits standard limited warranty and terms and conditions (collectively, "Standard Terms"); Purchasers of this part are entitled to the rights and benefits contained therein. For a full statement of the Standard Terms and the exclusive rights and remedies thereunder, please visit Mini-Circuits' website at www.minicircuits.com/MCLStore/terms.jsp



Ceramic, Hermetically Sealed Frequency Mixer WIDE BAND

MAC-60MH+

Level 13 (LO Power+13 dBm) 1600 to 6000 MHz



Generic photo used for illustration purposes only
CASE STYLE: DZ1650

Maximum Ratings

Operating Temperature	-55°C to 125°C
Storage Temperature	-65°C to 150°C
RF Power	50 mW
IF Current	40 mA

Permanent damage may occur if any of these limits are exceeded.

Pin Connections

LO	10
RF	5
IF	3
GROUND	1,2,4,6,7,8,9

Features

- wide bandwidth, 1600 to 6000 MHz
- low conversion loss, 6.5 dB typ.
- excellent L-R isolation, 35 dB typ.
- LTCC double balanced mixer
- aqueous washable
- low cost
- low profile, 0.060"
- protected by US Patent 7,027,795
- **3-YEAR GUARANTEE - The Most Reliable Mixers**

Applications

- PCN
- defense and weather radar
- WCDMA
- defense communications

+RoHS Compliant

The +Suffix identifies RoHS Compliance. See our web site for RoHS Compliance methodologies and qualifications

Reel Size	Devices/Reel
7"	20, 50, 100, 200
13"	500, 1000

Outline Drawing

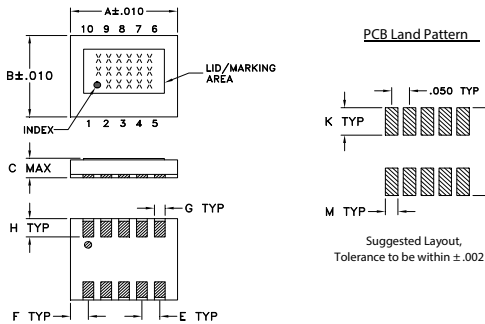

Outline Dimensions (inch/mm)

A	B	C	D	E	F	G	wt
.30	.250	.060	--	.050	.050	.030	
7.62	6.35	1.52	--	1.27	1.27	0.76	
H	J	K	L	M			grams
.056	--	.085	.270	.035			
1.42	--	2.16	6.86	0.89			0.29

Demo Board MCL P/N: TB-956+ Suggested PCB Layout (PL-045)

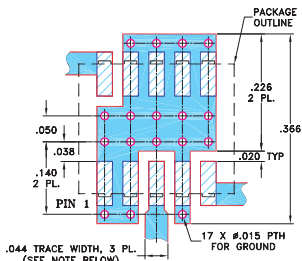

- NOTES: 1. TRACE WIDTH IS SHOWN FOR ROGERS RO4350B WITH DIELECTRIC THICKNESS $0.20 \pm .0015$ "; COPPER: 1/2 OZ. EACH SIDE. FOR OTHER MATERIALS TRACE WIDTH MAY NEED TO BE MODIFIED.
2. BOTTOM SIDE OF THE PCB IS CONTINUOUS GROUND PLANE.

- DENOTES PCB COPPER LAYOUT WITH SMOBC (SOLDER MASK OVER BARE COPPER)
- DENOTES COPPER LAND PATTERN FREE OF SOLDER MASK

Notes

- A. Performance and quality attributes and conditions not expressly stated in this specification document are intended to be excluded and do not form a part of this specification document.
B. Electrical specifications and performance data contained in this specification document are based on Mini-Circuit's applicable established test performance criteria and measurement instructions.
C. The parts covered by this specification document are subject to Mini-Circuit's standard limited warranty and terms and conditions (collectively, "Standard Terms"); Purchasers of this part are entitled to the rights and benefits contained therein. For a full statement of the Standard Terms and the exclusive rights and remedies thereunder, please visit Mini-Circuit's website at www.minicircuits.com/MCLStore/terms.jsp

Electrical Specifications at 25°C

Parameter	Condition (MHz)	Min.	Typ.	Max.	Units
Frequency Range, LO/RF			1600 - 6000		MHz
Frequency Range, IF			DC - 2000		MHz
Conversion Loss*	1600 - 4400	—	6.5	7.2	dB
	4400 - 6000	—	6.1	7.4	dB
LO to RF Isolation	1600 - 4400	30	35	—	dB
	4400 - 6000	20	24	—	dB
LO to IF Isolation	1600 - 4400	14	18	—	dB
	4400 - 6000	10	21	—	dB
IP3	1600 - 4400	—	17	—	dBm
	4400 - 6000	—	16	—	dBm
RF Input Power at 1 dB Compression	1600 - 6000		+9		dBm

*Conversion Loss measured at 30 MHz IF.

Typical Performance Data at 25°C and LO=+13 dBm

Frequency (MHz)	Conversion Loss (dB)		Isolation L-R (dB)		Isolation L-I (dB)		VSWR RF Port (:1)		VSWR LO Port (:1)	
	LO +13dBm	LO +13dBm	LO +13dBm	LO +13dBm	LO +13dBm	LO +13dBm	LO +13dBm	LO +13dBm	LO +13dBm	LO +13dBm
1600.1	6.76	32.32	17.62	2.54	3.70					
1800.1	6.15	39.96	19.62	2.94	2.28					
2000.1	6.06	38.16	19.96	3.11	1.79					
2200.1	5.64	33.71	19.77	2.70	1.74					
2400.1	5.60	34.29	18.70	2.39	1.79					
2600.1	5.55	32.95	18.55	1.82	1.80					
2800.1	6.04	39.53	18.57	2.68	1.98					
3000.1	6.64	33.87	18.03	3.28	2.24					
3200.1	6.47	34.63	17.30	2.90	2.56					
3400.1	6.74	34.00	16.41	2.94	2.85					
3600.1	6.62	35.65	15.72	2.96	3.18					
3800.1	6.60	37.59	16.55	2.82	3.43					
4000.1	6.99	39.07	16.83	2.70	3.52					
4600.1	5.76	30.62	20.19	1.83	3.06					
5000.1	6.34	25.52	21.92	2.14	1.56					
5200.1	6.15	23.59	21.32	1.87	1.17					
5400.1	5.85	21.51	18.70	1.74	1.66					
5600.1	5.99	21.72	13.71	1.65	2.59					
5800.1	6.09	22.94	12.15	1.89	4.29					
6000.1	7.01	24.00	11.83	2.82	7.29					

Electrical Schematic

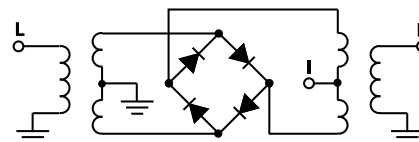

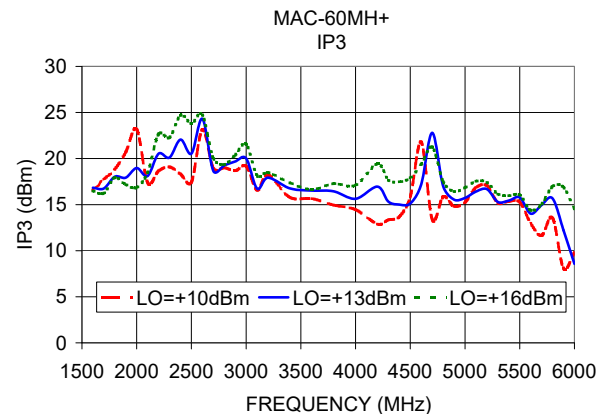
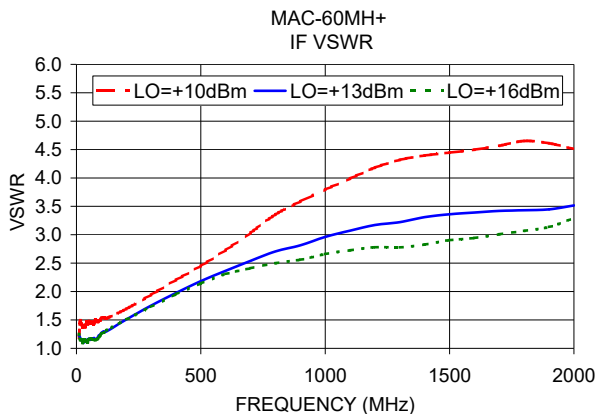
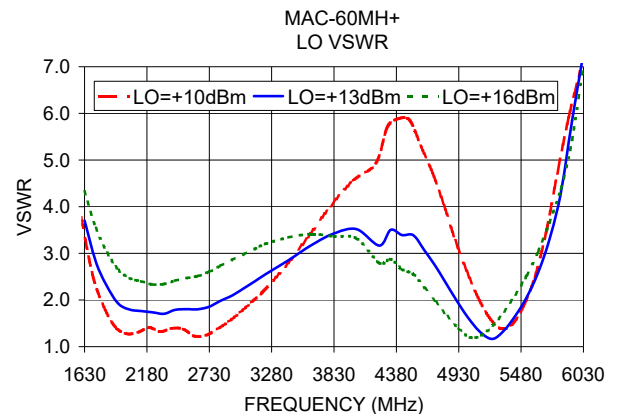
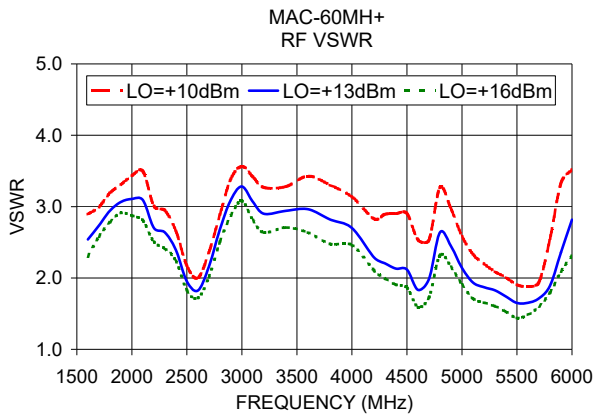
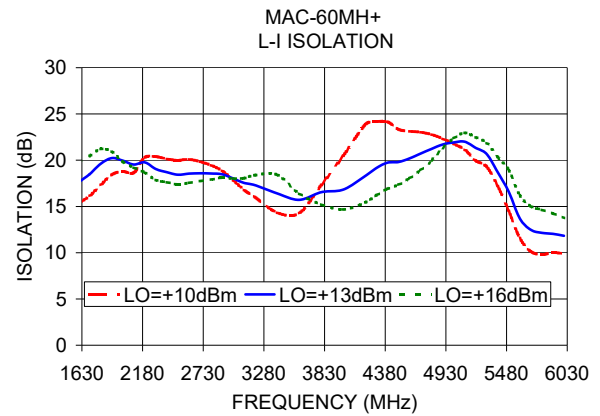
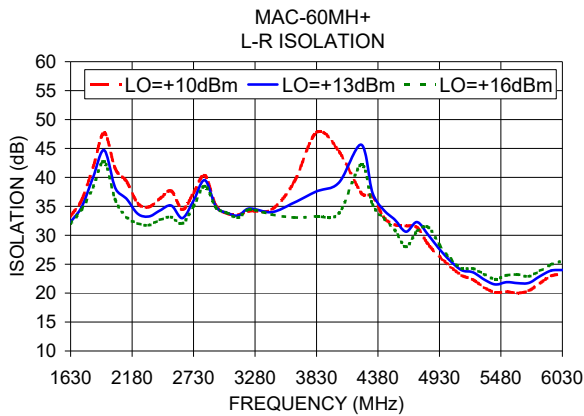
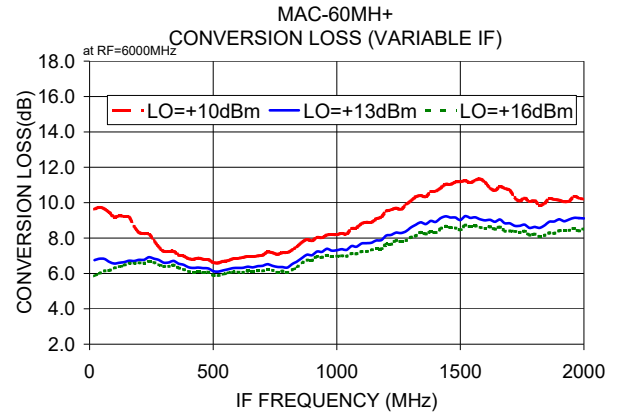
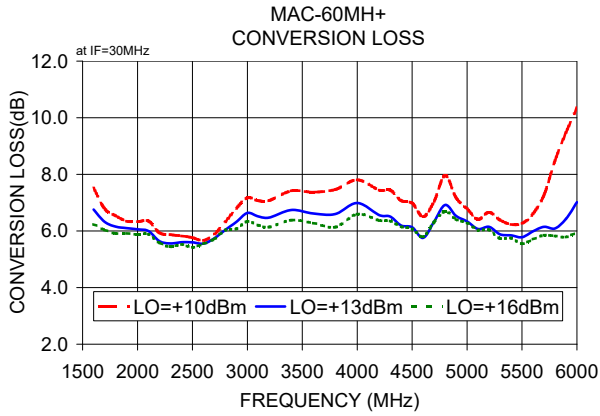

Notes

- A. Performance and quality attributes and conditions not expressly stated in this specification document are intended to be excluded and do not form a part of this specification document.
- B. Electrical specifications and performance data contained in this specification document are based on Mini-Circuit's applicable established test performance criteria and measurement instructions.
- C. The parts covered by this specification document are subject to Mini-Circuits standard limited warranty and terms and conditions (collectively, "Standard Terms"); Purchasers of this part are entitled to the rights and benefits contained therein. For a full statement of the Standard Terms and the exclusive rights and remedies thereunder, please visit Mini-Circuits' website at www.minicircuits.com/MCLStore/terms.jsp



Designed and Built for Long-Term Reliability in HOSTILE ENVIRONMENTS

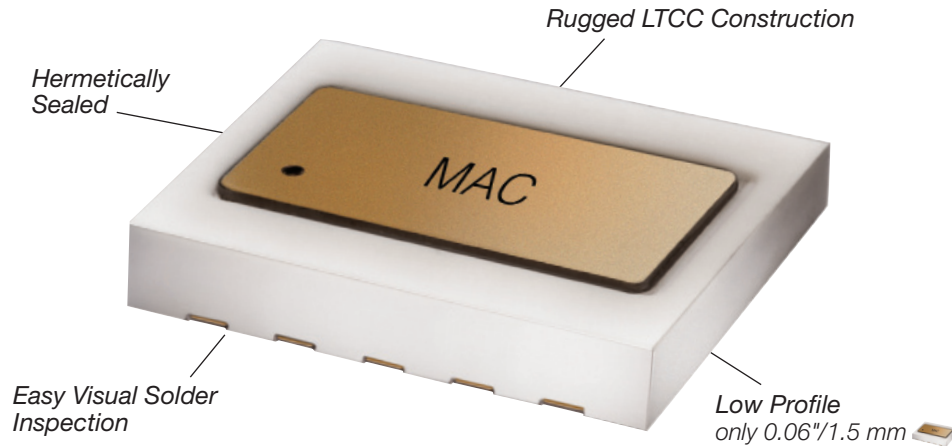

Qualification Testing

The table below shows the initial qualification testing performed. If required, parts can be subjected to 100% screening and qualifications testing per MIL standard requirement.

Gross Leak	MIL-STD-202 Method 112, Condition D (100% of all MAC Mixers we ship)
Fine Leak	MIL-STD-202 Method 112, Condition C, Procedure IIIa
Thermal Shock	MIL-STD-202 Method 107 (-55/+100C°, 1000 cycles, 15 minutes) (-55/+150C°, 1000 cycles, 15 minutes)
Vibration	MIL-STD-202 Method 204, Condition D (10-2000Hz sine, 20g, 3 axis, 12 c.y.ea.)
Acceleration	MIL- STD-883 Method 2001, Condition E
Mechanical Shock	MIL-STD-202 Method 213, Condition A
HTOL	MIL-STD-202 Method 108, Condition D (1000 hours, 125°C, at rated LO level)
Multiple Reflow	JESD22-B102
Bend Test	JESD22-B113
Adhesion Strength	Push test >10lb



All Photos courtesy of U.S. Military and NASA

Notes

- Performance and quality attributes and conditions not expressly stated in this specification document are intended to be excluded and do not form a part of this specification document.
- Electrical specifications and performance data contained in this specification document are based on Mini-Circuit's applicable established test performance criteria and measurement instructions.
- The parts covered by this specification document are subject to Mini-Circuits standard limited warranty and terms and conditions (collectively, "Standard Terms"); Purchasers of this part are entitled to the rights and benefits contained therein. For a full statement of the Standard Terms and the exclusive rights and remedies thereunder, please visit Mini-Circuits' website at www.minicircuits.com/MCLStore/terms.jsp



Frequency Mixer

MAC-60MH+

Typical Performance Data

RF (IN) (MHz)	LO (MHz)	CONVERSION LOSS IF FIXED @IF(OUT)=30MHz (dB)		
		@LO (dBm)		
		+10	+13	+16
1600.1	1630.1	7.52	6.76	6.24
1700.1	1730.1	6.79	6.32	6.04
1800.1	1830.1	6.54	6.15	5.91
1900.1	1930.1	6.35	6.10	5.92
2000.1	2030.1	6.33	6.06	5.88
2100.1	2130.1	6.35	6.00	5.89
2200.1	2230.1	5.93	5.64	5.58
2300.1	2330.1	5.87	5.56	5.44
2400.1	2430.1	5.83	5.60	5.53
2500.1	2530.1	5.76	5.60	5.42
2600.1	2630.1	5.66	5.55	5.55
2700.1	2730.1	5.89	5.74	5.71
2800.1	2830.1	6.33	6.04	6.03
2900.1	2930.1	6.80	6.32	6.07
3000.1	3030.1	7.17	6.64	6.34
3100.1	3130.1	7.07	6.52	6.20
3200.1	3230.1	7.08	6.47	6.14
3400.1	3430.1	7.42	6.74	6.38
3600.1	3630.1	7.37	6.62	6.28
3800.1	3830.1	7.46	6.60	6.13
4000.1	4030.1	7.81	6.99	6.59
4200.1	4230.1	7.44	6.56	6.37
4300.1	4330.1	7.44	6.51	6.36
4400.1	4430.1	7.07	6.19	6.15
4500.1	4530.1	6.99	6.13	6.08
4600.1	4630.1	6.50	5.76	5.79
4700.1	4730.1	7.04	6.33	6.31
4800.1	4830.1	7.96	6.92	6.69
4900.1	4930.1	7.17	6.53	6.41
5000.1	5030.1	6.78	6.34	6.28
5100.1	5130.1	6.41	6.07	6.04
5200.1	5230.1	6.66	6.15	6.04
5300.1	5330.1	6.39	5.88	5.74
5400.1	5430.1	6.23	5.85	5.75
5500.1	5530.1	6.27	5.78	5.55
5600.1	5630.1	6.61	5.99	5.71
5700.1	5730.1	7.27	6.15	5.85
5800.1	5830.1	8.48	6.09	5.82
5900.1	5930.1	9.48	6.43	5.78
6000.1	6030.1	10.35	7.01	5.96

RF (IN) (MHz)	LO (MHz)	IP-3 INPUT (dBm)		
		@LO (dBm)		
		+10	+13	+16
1600.1	1630.1	16.57	16.83	16.49
1700.1	1730.1	17.73	16.75	16.24
1800.1	1830.1	18.83	18.03	17.93
1900.1	1930.1	20.68	17.92	17.19
2000.1	2030.1	23.18	18.97	16.85
2100.1	2130.1	17.39	18.10	18.46
2200.1	2230.1	18.63	20.53	22.66
2300.1	2330.1	19.09	20.11	22.27
2400.1	2430.1	18.30	22.06	24.70
2500.1	2530.1	17.43	20.54	23.80
2600.1	2630.1	23.15	24.32	24.74
2700.1	2730.1	18.93	18.65	20.02
2800.1	2830.1	19.00	19.26	19.35
2900.1	2930.1	18.68	19.68	20.39
3000.1	3030.1	19.16	20.01	21.55
3100.1	3130.1	16.59	16.74	18.14
3200.1	3230.1	18.22	17.93	18.48
3400.1	3430.1	15.79	16.77	17.37
3600.1	3630.1	15.66	16.52	16.63
3800.1	3830.1	14.95	16.44	17.28
4000.1	4030.1	14.46	15.64	17.11
4200.1	4230.1	12.90	16.95	19.41
4300.1	4330.1	13.34	15.33	17.67
4400.1	4430.1	13.69	15.00	17.47
4500.1	4530.1	15.82	15.12	17.90
4600.1	4630.1	21.78	17.18	19.36
4700.1	4730.1	13.40	22.80	21.24
4800.1	4830.1	15.85	17.00	17.47
4900.1	4930.1	14.81	15.54	16.43
5000.1	5030.1	15.26	15.73	16.84
5100.1	5130.1	16.84	16.41	17.54
5200.1	5230.1	17.06	16.68	17.41
5300.1	5330.1	15.18	15.29	16.16
5400.1	5430.1	15.36	15.44	15.97
5500.1	5530.1	15.26	15.77	16.05
5600.1	5630.1	12.97	14.02	14.40
5700.1	5730.1	11.66	14.96	15.06
5800.1	5830.1	13.56	15.67	16.98
5900.1	5930.1	8.10	12.22	16.87
6000.1	6030.1	9.79	8.58	14.53

RF (IN) (MHz)	LO (MHz)	COMPRESSION @RF IN=+9dBm (dB)		
		@LO (dBm)		
		+10	+13	+16
1600.1	1630.1	2.06	1.91	1.80
1700.1	1730.1	2.09	1.86	1.69
1800.1	1830.1	1.74	1.59	1.51
1900.1	1930.1	1.48	1.26	1.22
2000.1	2030.1	1.28	1.10	1.07
2100.1	2130.1	1.27	1.17	1.07
2200.1	2230.1	1.20	0.98	0.81
2300.1	2330.1	1.20	0.98	0.82
2400.1	2430.1	1.19	0.87	0.70
2500.1	2530.1	1.10	0.66	0.62
2600.1	2630.1	1.11	0.69	0.55
2700.1	2730.1	1.33	0.99	0.77
2800.1	2830.1	1.65	1.31	0.94
2900.1	2930.1	1.56	1.27	1.08
3000.1	3030.1	1.46	1.30	1.11
3100.1	3130.1	1.34	1.19	1.06
3200.1	3230.1	1.18	1.11	0.96
3400.1	3430.1	1.18	1.12	1.05
3600.1	3630.1	0.98	0.89	0.85
3800.1	3830.1	1.36	0.89	0.86
4000.1	4030.1	1.18	0.71	0.60
4200.1	4230.1	1.18	0.87	0.72
4300.1	4330.1	1.09	0.76	0.66
4400.1	4430.1	1.20	0.84	0.73
4500.1	4530.1	1.06	0.70	0.53
4600.1	4630.1	1.24	0.79	0.55
4700.1	4730.1	1.46	1.14	0.75
4800.1	4830.1	0.78	0.96	0.87
4900.1	4930.1	1.03	0.94	0.89
5000.1	5030.1	1.08	0.86	0.80
5100.1	5130.1	1.13	0.79	0.72
5200.1	5230.1	1.09	0.90	0.79
5300.1	5330.1	1.41	1.33	1.23
5400.1	5430.1	1.45	1.24	1.09
5500.1	5530.1	1.28	1.06	1.01
5600.1	5630.1	1.50	1.31	1.28
5700.1	5730.1	1.70	1.53	1.44
5800.1	5830.1	1.54	2.02	1.64
5900.1	5930.1	1.97	2.52	2.11
6000.1	6030.1	2.75	3.36	2.52

Frequency Mixer

MAC-60MH+

Typical Performance Data

IF (OUT) (MHz)	LO (MHz)	CONVERSION LOSS VS. IF FREQUENCY @RF(IN)=3800.1MHz (dB)	IF (OUT) (MHz)	LO (MHz)	CONVERSION LOSS VS. IF FREQUENCY @RF(IN)=1600.1MHz (dB)	IF (OUT) (MHz)	LO (MHz)	CONVERSION LOSS VS. IF FREQUENCY @RF(IN)=6000.1MHz (dB)
		@LO (dBm)			@LO (dBm)			@LO (dBm)
		+13			+13			+13
2800.0	1000.1	16.31	10.0	1610.1	6.67	3200.0	2800.1	17.02
2600.0	1200.1	13.74	20.0	1620.1	6.77	3100.0	2900.1	14.79
2400.0	1400.1	11.31	30.0	1630.1	6.75	3000.0	3000.1	12.35
2200.0	1600.1	9.87	40.0	1640.1	6.55	2900.0	3100.1	11.54
2000.0	1800.1	8.28	50.0	1650.1	6.64	2800.0	3200.1	11.32
1800.0	2000.1	8.23	60.0	1660.1	6.51	2700.0	3300.1	10.72
1600.0	2200.1	8.04	70.0	1670.1	6.49	2600.0	3400.1	10.26
1400.0	2400.1	9.61	80.0	1680.1	6.42	2500.0	3500.1	9.92
1200.0	2600.1	9.21	90.0	1690.1	6.47	2400.0	3600.1	9.84
1000.0	2800.1	9.35	100.0	1700.1	6.39	2300.0	3700.1	9.62
800.0	3000.1	8.07	110.0	1710.1	6.43	2200.0	3800.1	9.15
600.0	3200.1	6.89	200.0	1800.1	6.05	2100.0	3900.1	9.03
400.0	3400.1	6.52	300.0	1900.1	5.92	2000.0	4000.1	9.11
200.0	3600.1	6.36	400.0	2000.1	5.93	1900.0	4100.1	9.06
120.0	3680.1	6.43	500.0	2100.1	5.97	1800.0	4200.1	8.63
100.0	3700.1	6.40	600.0	2200.1	5.95	1700.0	4300.1	8.83
80.0	3720.1	6.47	700.0	2300.1	6.10	1600.0	4400.1	9.00
60.0	3740.1	6.36	800.0	2400.1	6.36	1500.0	4500.1	9.02
40.0	3760.1	6.29	900.0	2500.1	6.84	1400.0	4600.1	8.91
20.0	3780.1	6.29	1000.0	2600.1	6.96	1300.0	4700.1	8.60
10.0	3810.1	6.35	1100.0	2700.1	6.92	1200.0	4800.1	8.14
30.0	3830.1	6.57	1200.0	2800.1	6.70	1100.0	4900.1	7.69
50.0	3850.1	6.47	1300.0	2900.1	6.52	1000.0	5000.1	7.31
70.0	3870.1	6.51	1400.0	3000.1	6.58	900.0	5100.1	7.03
90.0	3890.1	6.55	1500.0	3100.1	6.90	800.0	5200.1	6.33
110.0	3910.1	6.64	1600.0	3200.1	6.75	700.0	5300.1	6.43
130.0	3930.1	6.73	1700.0	3300.1	6.98	600.0	5400.1	6.31
150.0	3950.1	6.70	1800.0	3400.1	7.52	500.0	5500.1	6.13
300.0	4100.1	7.00	1900.0	3500.1	8.03	400.0	5600.1	6.35
500.0	4300.1	6.85	2000.0	3600.1	8.31	300.0	5700.1	6.61
700.0	4500.1	6.67	2100.0	3700.1	8.01	200.0	5800.1	6.77
900.0	4700.1	7.34	2200.0	3800.1	8.24	180.0	5820.1	6.70
1100.0	4900.1	8.44	2300.0	3900.1	7.92	160.0	5840.1	6.72
1300.0	5100.1	8.91	2400.0	4000.1	7.89	140.0	5860.1	6.64
1500.0	5300.1	8.30	2500.0	4100.1	8.29	120.0	5880.1	6.60
1700.0	5500.1	7.95	2600.0	4200.1	9.25	100.0	5900.1	6.56
1900.0	5700.1	9.11	2700.0	4300.1	10.08	80.0	5920.1	6.65
2100.0	5900.1	10.24	2800.0	4400.1	11.42	60.0	5940.1	6.82
2300.0	6100.1	13.10	2900.0	4500.1	12.76	40.0	5960.1	6.83
2500.0	6300.1	15.45	3000.0	4600.1	14.16	20.0	5980.1	6.75

Frequency Mixer

MAC-60MH+

Typical Performance Data

LO (MHz)	LO-RF ISOLATION (dB)			LO-IF ISOLATION (dB)			RF (IN) (MHz)	LO (MHz)	RF-IF ISOLATION (dB)		
	@LO (dBm)			@LO (dBm)					@LO (dBm)		
	+10	+13	+16	+10	+13	+16			+10	+13	+16
1630.1	33.32	32.32	32.04	15.35	17.62	19.75	1600.1	1630.1	13.19	12.02	11.32
1730.1	36.11	34.93	34.45	16.14	18.49	20.47	1700.1	1730.1	14.72	13.70	13.03
1830.1	41.69	39.96	38.29	17.32	19.62	21.21	1800.1	1830.1	17.99	16.90	16.05
1930.1	47.70	44.71	42.75	18.43	20.23	20.93	1900.1	1930.1	20.58	20.14	19.68
2030.1	41.48	38.16	36.10	18.78	19.96	19.83	2000.1	2030.1	21.54	21.92	22.09
2130.1	39.29	36.29	33.15	18.64	19.53	19.19	2100.1	2130.1	24.12	24.13	22.71
2230.1	35.53	33.71	32.06	20.29	19.77	18.67	2200.1	2230.1	24.15	22.81	21.62
2330.1	34.88	33.24	31.73	20.38	19.05	17.87	2300.1	2330.1	23.72	22.34	21.15
2430.1	36.34	34.29	32.65	20.13	18.70	17.61	2400.1	2430.1	21.86	20.78	19.94
2530.1	37.65	35.14	33.16	20.00	18.43	17.38	2500.1	2530.1	19.59	18.74	18.16
2630.1	34.47	32.95	32.01	20.09	18.55	17.55	2600.1	2630.1	18.76	18.22	17.85
2730.1	37.31	35.98	34.99	19.85	18.59	17.74	2700.1	2730.1	19.11	18.67	18.37
2830.1	40.35	39.53	38.49	19.46	18.57	17.90	2800.1	2830.1	20.61	20.26	19.92
2930.1	35.11	34.94	34.79	18.87	18.48	18.11	2900.1	2930.1	23.33	22.61	22.02
3030.1	33.77	33.87	33.86	17.85	18.03	18.02	3000.1	3030.1	23.84	23.57	23.18
3130.1	33.55	33.42	33.05	16.79	17.55	18.05	3100.1	3130.1	20.59	20.72	20.56
3230.1	34.18	34.63	34.47	16.00	17.30	18.38	3200.1	3230.1	19.78	20.12	20.20
3430.1	34.45	34.00	33.59	14.33	16.41	18.43	3400.1	3430.1	20.86	21.17	21.37
3630.1	39.21	35.65	33.08	14.28	15.72	16.39	3600.1	3630.1	30.20	29.96	29.73
3830.1	47.79	37.59	33.28	17.32	16.55	15.21	3800.1	3830.1	17.65	17.55	17.50
4030.1	44.52	39.07	33.78	20.49	16.83	14.68	4000.1	4030.1	14.12	14.00	13.93
4230.1	37.31	45.66	42.18	23.86	18.31	15.44	4200.1	4230.1	13.17	13.04	12.87
4330.1	36.82	37.39	35.34	24.17	19.15	16.21	4300.1	4330.1	13.30	13.09	12.87
4430.1	33.16	34.40	32.94	24.16	19.73	16.90	4400.1	4430.1	13.60	13.64	13.46
4530.1	31.81	32.70	30.91	23.34	19.81	17.34	4500.1	4530.1	13.93	14.05	14.02
4630.1	31.61	30.62	27.99	23.12	20.19	18.04	4600.1	4630.1	13.99	13.97	14.01
4730.1	31.34	32.27	30.70	23.02	20.71	18.92	4700.1	4730.1	14.98	14.82	14.83
4830.1	28.37	30.03	31.40	22.78	21.22	19.99	4800.1	4830.1	14.81	14.55	14.43
4930.1	26.38	27.61	28.34	22.33	21.70	21.31	4900.1	4930.1	14.52	14.24	14.18
5030.1	24.55	25.52	25.98	21.77	21.92	22.37	5000.1	5030.1	14.28	13.86	13.87
5130.1	23.06	23.95	24.27	21.14	22.00	22.96	5100.1	5130.1	14.43	14.13	14.24
5230.1	22.33	23.59	24.24	19.96	21.32	22.48	5200.1	5230.1	14.74	14.62	14.82
5330.1	20.99	22.36	23.28	19.28	20.67	21.86	5300.1	5330.1	15.23	15.15	15.28
5430.1	20.11	21.51	22.41	17.20	18.70	20.35	5400.1	5430.1	14.36	13.93	13.80
5530.1	20.26	21.90	23.08	14.52	16.59	18.93	5500.1	5530.1	15.15	14.84	14.89
5630.1	20.00	21.72	23.19	11.57	13.71	16.20	5600.1	5630.1	19.14	18.51	18.30
5730.1	20.43	21.77	22.90	10.13	12.47	15.01	5700.1	5730.1	21.30	20.30	19.83
5830.1	21.73	22.94	23.85	9.81	12.15	14.63	5800.1	5830.1	26.04	22.92	21.87
5930.1	22.99	23.89	24.96	10.00	12.04	14.24	5900.1	5930.1	25.49	24.47	22.43
6030.1	23.25	24.00	25.54	9.90	11.83	13.74	6000.1	6030.1	21.83	23.30	22.38

Typical Performance Data

RF (IN) (MHz)	LO (MHz)	RF VSWR (:1)			LO (MHz)	LO VSWR (:1)			IF (OUT) (MHz)	IF VSWR @LO=6000.1MHz (:1)		
		@LO (dBm)				@LO (dBm)				@LO (dBm)		
		+10	+13	+16		+10	+13	+16		+10	+13	+16
1600.1	1630.1	2.89	2.54	2.30	1630.1	3.77	3.70	4.32	10.1	2.85	1.62	1.14
1700.1	1730.1	2.99	2.73	2.58	1730.1	2.54	2.81	3.54	15.1	3.17	1.73	1.16
1800.1	1830.1	3.19	2.94	2.78	1830.1	1.85	2.28	3.01	20.1	3.08	1.73	1.19
1900.1	1930.1	3.31	3.06	2.91	1930.1	1.43	1.92	2.64	25.1	3.09	1.76	1.19
2000.1	2030.1	3.43	3.11	2.87	2030.1	1.28	1.79	2.47	30.1	3.26	1.81	1.18
2100.1	2130.1	3.49	3.09	2.80	2130.1	1.31	1.76	2.40	35.1	3.29	1.84	1.21
2200.1	2230.1	3.01	2.70	2.51	2230.1	1.41	1.74	2.33	40.1	3.35	1.86	1.25
2300.1	2330.1	2.95	2.64	2.41	2330.1	1.32	1.70	2.34	45.1	3.47	1.90	1.26
2400.1	2430.1	2.66	2.39	2.24	2430.1	1.39	1.79	2.41	50.1	3.45	1.92	1.28
2500.1	2530.1	2.17	1.95	1.83	2530.1	1.38	1.80	2.47	55.1	3.41	1.88	1.29
2600.1	2630.1	2.00	1.82	1.72	2630.1	1.23	1.80	2.51	60.1	3.48	1.93	1.30
2700.1	2730.1	2.36	2.16	2.01	2730.1	1.24	1.86	2.61	65.1	3.43	1.90	1.30
2800.1	2830.1	2.89	2.68	2.51	2830.1	1.37	1.98	2.73	70.1	3.44	1.91	1.30
2900.1	2930.1	3.39	3.10	2.87	2930.1	1.54	2.09	2.86	75.1	3.47	1.94	1.30
3000.1	3030.1	3.56	3.28	3.08	3030.1	1.73	2.24	2.97	80.1	3.42	1.92	1.30
3100.1	3130.1	3.42	3.07	2.81	3130.1	1.95	2.40	3.09	85.1	3.40	1.91	1.30
3200.1	3230.1	3.27	2.90	2.64	3230.1	2.17	2.56	3.21	90.1	3.41	1.94	1.33
3400.1	3430.1	3.28	2.94	2.71	3430.1	2.72	2.85	3.34	95.1	3.42	1.94	1.34
3600.1	3630.1	3.43	2.96	2.64	3630.1	3.35	3.18	3.41	100.1	3.46	1.96	1.38
3800.1	3830.1	3.30	2.82	2.48	3830.1	4.01	3.43	3.36	110.1	3.40	1.95	1.40
4000.1	4030.1	3.14	2.70	2.46	4030.1	4.56	3.52	3.32	120.1	3.46	1.98	1.42
4200.1	4230.1	2.83	2.29	2.11	4230.1	4.93	3.17	2.79	200.1	3.68	2.18	1.65
4300.1	4330.1	2.89	2.20	1.99	4330.1	5.71	3.50	2.87	300.1	4.05	2.48	1.94
4400.1	4430.1	2.90	2.13	1.91	4430.1	5.89	3.39	2.66	400.1	4.44	2.76	2.19
4500.1	4530.1	2.90	2.12	1.86	4530.1	5.85	3.39	2.55	500.1	4.86	3.00	2.40
4600.1	4630.1	2.53	1.83	1.59	4630.1	5.28	3.06	2.26	600.1	5.43	3.28	2.59
4700.1	4730.1	2.53	1.99	1.73	4730.1	4.72	2.71	1.96	700.1	6.06	3.59	2.73
4800.1	4830.1	3.27	2.64	2.32	4830.1	4.03	2.31	1.65	800.1	6.53	3.86	2.86
4900.1	4930.1	2.97	2.45	2.16	4930.1	3.28	1.92	1.39	900.1	6.83	4.02	2.92
5000.1	5030.1	2.59	2.14	1.91	5030.1	2.63	1.56	1.20	1000.1	6.99	4.18	3.03
5100.1	5130.1	2.33	1.94	1.71	5130.1	2.05	1.29	1.24	1100.1	7.16	4.37	3.09
5200.1	5230.1	2.20	1.87	1.66	5230.1	1.62	1.17	1.45	1200.1	7.47	4.61	3.19
5300.1	5330.1	2.09	1.83	1.60	5330.1	1.39	1.35	1.76	1300.1	7.47	4.71	3.21
5400.1	5430.1	2.01	1.74	1.53	5430.1	1.48	1.66	2.12	1400.1	7.31	4.87	3.24
5500.1	5530.1	1.90	1.65	1.44	5530.1	1.86	2.06	2.53	1500.1	7.19	5.14	3.29
5600.1	5630.1	1.88	1.65	1.48	5630.1	2.48	2.59	3.04	1600.1	7.18	5.51	3.30
5700.1	5730.1	1.94	1.72	1.60	5730.1	3.44	3.30	3.66	1700.1	7.44	6.04	3.35
5800.1	5830.1	2.55	1.89	1.79	5830.1	4.71	4.29	4.38	1800.1	8.18	6.36	3.35
5900.1	5930.1	3.33	2.36	2.09	5930.1	5.92	5.85	5.43	1900.1	8.67	6.20	3.34
6000.1	6030.1	3.52	2.82	2.31	6030.1	6.90	7.29	7.05	2000.1	8.62	5.76	3.37

Harmonics Tables

RF HARMONICS ORDER

	(-dBm)	(-dBc)										
0	---	---	-9.71	20.21	23.94	31.10	16.96	70.32	---	---	---	---
1	---	11.38	---	29.87	19.76	45.74	33.36	62.02	73.03	---	---	---
2	116.09	50.94	43.97	51.40	45.63	52.41	71.59	50.64	53.33	85.21	---	---
3	123.05	66.25	57.52	72.74	65.44	65.19	68.69	73.47	72.07	78.65	100.90	---
4	124.97	85.18	102.04	89.79	84.37	90.75	82.36	89.02	100.31	79.43	84.50	108.77
5	119.07	101.46	102.56	102.65	102.99	97.38	91.60	99.62	98.01	107.85	99.18	96.06
6	131.26	114.47	103.56	100.38	104.03	104.74	90.57	98.77	86.48	105.66	108.44	99.32
7	---	---	110.63	98.38	102.68	103.16	103.26	90.03	98.36	86.12	109.32	108.16
8	---	---	---	112.88	100.16	101.56	104.40	103.73	103.30	102.10	108.40	112.03
9	---	---	---	---	108.61	101.30	101.81	103.70	101.83	105.97	108.35	107.19
10	---	---	---	---	---	111.34	103.13	103.96	106.34	105.76	104.26	107.31
	RF CAL	0	1	2	3	4	5	6	7	8	9	10

LO HARMONICS ORDER

Test conditions:

RF IN: 3800.1 MHz; -6.00 dBm
 LO IN: 3830.1 MHz; +13.00 dBm
 IF OUT: 30 MHz; -12.32 dBm

RF HARMONICS ORDER

	(-dBm)	(-dBc)										
0	---	---	0.33	31.15	35.20	51.28	31.23	89.00	---	---	---	---
1	---	11.14	---	34.10	19.82	50.91	34.05	61.37	82.59	---	---	---
2	106.62	39.50	34.40	41.32	38.21	45.65	61.13	48.05	48.44	102.57	---	---
3	137.85	46.27	37.49	54.30	46.74	46.37	51.78	57.60	66.64	72.73	93.79	---
4	110.65	57.24	81.50	60.59	57.82	60.04	55.13	60.19	84.63	56.81	66.79	93.46
5	105.26	88.79	75.06	77.11	68.83	77.06	55.22	68.56	63.55	73.94	64.68	77.08
6	120.48	116.07	78.83	78.27	97.24	80.87	75.84	75.72	73.80	78.01	94.34	69.09
7	---	---	121.04	95.43	100.67	91.18	81.26	96.83	73.29	75.94	82.02	86.83
8	---	---	---	113.06	90.62	90.18	105.04	91.97	90.71	90.47	84.49	83.21
9	---	---	---	---	111.25	102.65	113.28	98.53	95.05	108.80	85.29	87.39
10	---	---	---	---	---	109.08	97.93	102.16	98.96	104.51	98.91	98.96
	RF CAL	0	1	2	3	4	5	6	7	8	9	10

LO HARMONICS ORDER

Test conditions:

RF IN: 3800.1 MHz; 4.00 dBm
 LO IN: 3830.1 MHz; +13.00 dBm
 IF OUT: 30 MHz; -2.3 dBm

- Notes:
1. All Harmonics are in (dBc) relative to IF OUTPUT
 2. + entry denotes harmonics are in (dBc) above IF OUTPUT
 3. RF Cal represents the Harmonics level of the RF Input Signal to the mixer

Typical Performance Curves

Conversion Loss @IF=30 MHz

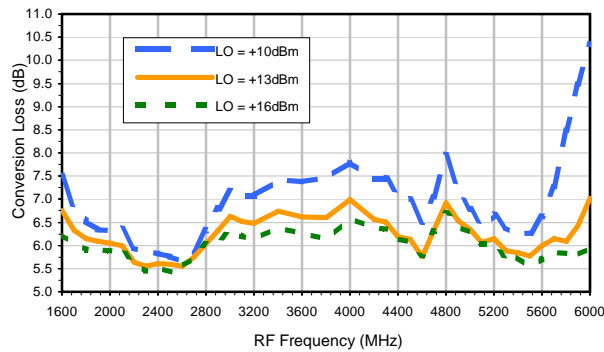

Conversion Loss vs. LO @ RF=3800.1 MHz

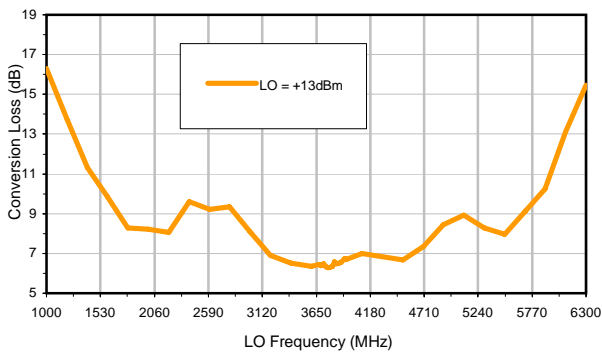

Conversion Loss vs. IF @ RF=3800.1 MHz

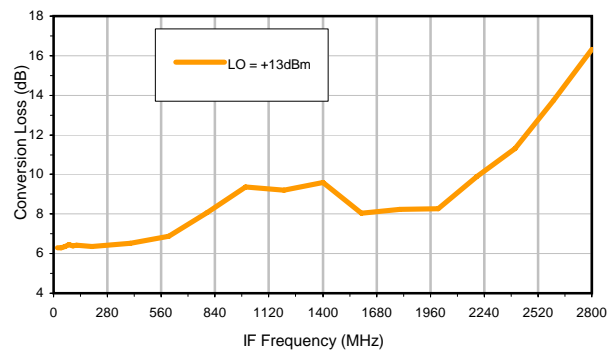

Conversion Loss vs. IF @ RF=1600.1 MHz

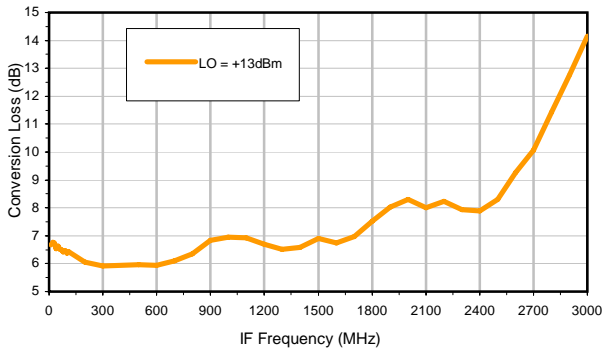

Conversion Loss vs. IF @ RF=6000.1 MHz

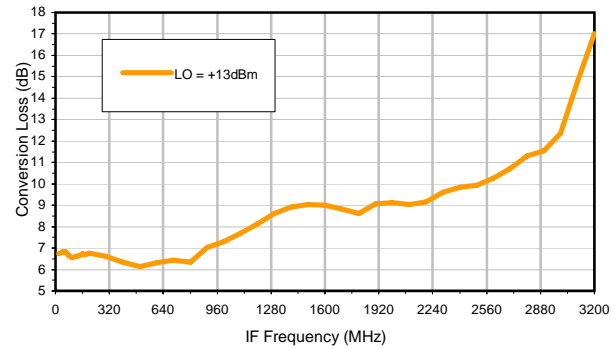

IP-3 Input

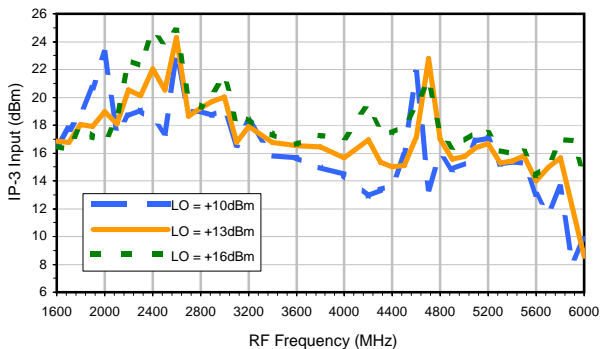

Compression @RF IN=+9 dBm

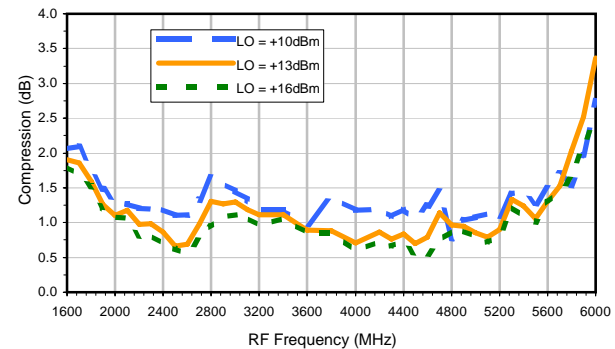

Typical Performance Curves

LO-RF Isolation

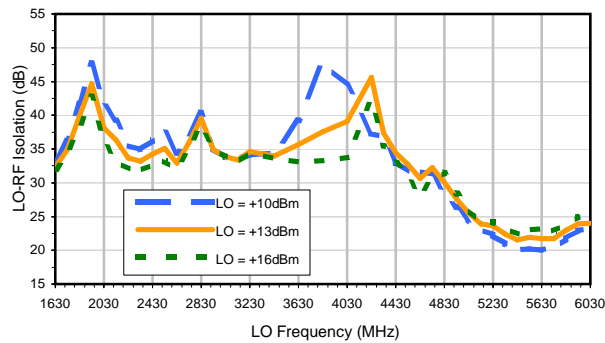

LO-IF Isolation

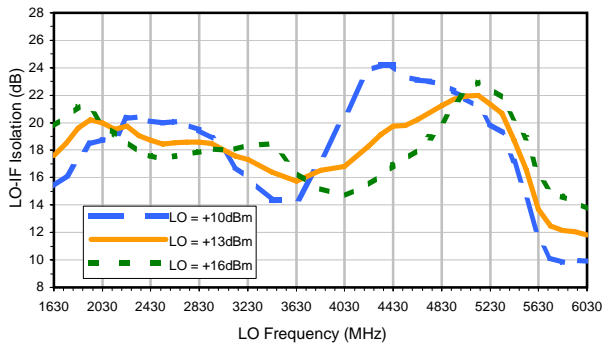

RF-IF Isolation

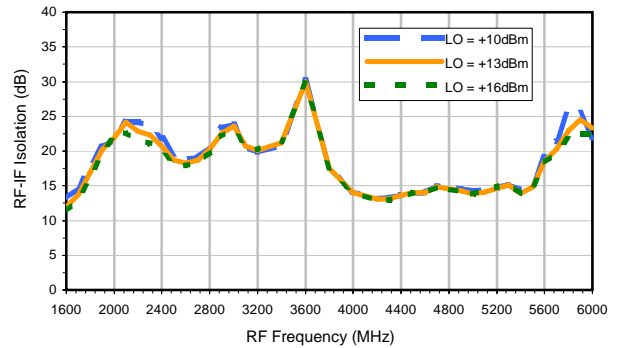

RF VSWR

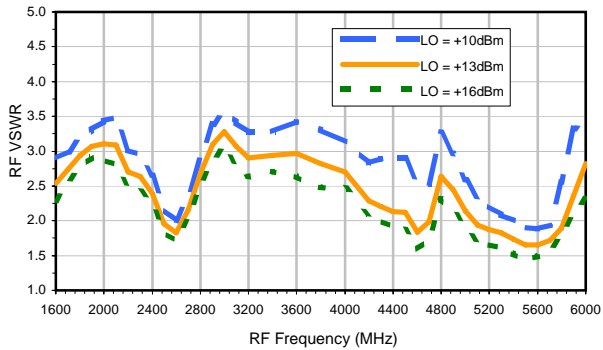

LO VSWR

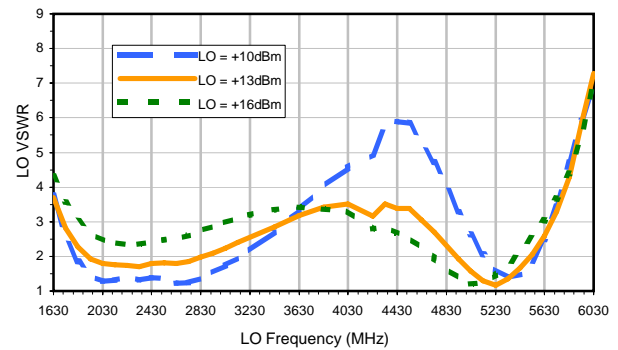

IF VSWR

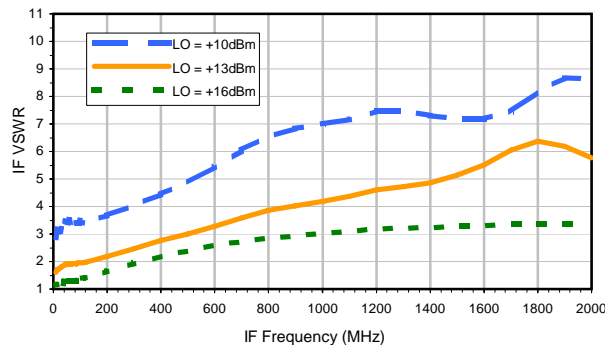

Harmonics Tables

RF HARMONICS ORDER

	(-dBm)	(-dBc)										
0	---	---	-9.71	20.21	23.94	31.10	16.96	70.32	---	---	---	---
1	---	11.38	---	29.87	19.76	45.74	33.36	62.02	73.03	---	---	---
2	116.09	50.94	43.97	51.40	45.63	52.41	71.59	50.64	53.33	85.21	---	---
3	123.05	66.25	57.52	72.74	65.44	65.19	68.69	73.47	72.07	78.65	100.90	---
4	124.97	85.18	102.04	89.79	84.37	90.75	82.36	89.02	100.31	79.43	84.50	108.77
5	119.07	101.46	102.56	102.65	102.99	97.38	91.60	99.62	98.01	107.85	99.18	96.06
6	131.26	114.47	103.56	100.38	104.03	104.74	90.57	98.77	86.48	105.66	108.44	99.32
7	---	---	110.63	98.38	102.68	103.16	103.26	90.03	98.36	86.12	109.32	108.16
8	---	---	---	112.88	100.16	101.56	104.40	103.73	103.30	102.10	108.40	112.03
9	---	---	---	---	108.61	101.30	101.81	103.70	101.83	105.97	108.35	107.19
10	---	---	---	---	---	111.34	103.13	103.96	106.34	105.76	104.26	107.31
	RF CAL	0	1	2	3	4	5	6	7	8	9	10

LO HARMONICS ORDER

Test conditions:

RF IN: 3800.1 MHz; -6.00 dBm
 LO IN: 3830.1 MHz; +13.00 dBm
 IF OUT: 30 MHz; -12.32 dBm

F RF HARMONICS ORDER

	(-dBm)	(-dBc)										
0	---	---	0.33	31.15	35.20	51.28	31.23	89.00	---	---	---	---
1	---	11.14	---	34.10	19.82	50.91	34.05	61.37	82.59	---	---	---
2	106.62	39.50	34.40	41.32	38.21	45.65	61.13	48.05	48.44	102.57	---	---
3	137.85	46.27	37.49	54.30	46.74	46.37	51.78	57.60	66.64	72.73	93.79	---
4	110.65	57.24	81.50	60.59	57.82	60.04	55.13	60.19	84.63	56.81	66.79	93.46
5	105.26	88.79	75.06	77.11	68.83	77.06	55.22	68.56	63.55	73.94	64.68	77.08
6	120.48	116.07	78.83	78.27	97.24	80.87	75.84	75.72	73.80	78.01	94.34	69.09
7	---	---	121.04	95.43	100.67	91.18	81.26	96.83	73.29	75.94	82.02	86.83
8	---	---	---	113.06	90.62	90.18	105.04	91.97	90.71	90.47	84.49	83.21
9	---	---	---	---	111.25	102.65	113.28	98.53	95.05	108.80	85.29	87.39
10	---	---	---	---	---	109.08	97.93	102.16	98.96	104.51	98.91	98.96
	RF CAL	0	1	2	3	4	5	6	7	8	9	10

LO HARMONICS ORDER

Test conditions:

RF IN: 3800.1 MHz; 4.00 dBm
 LO IN: 3830.1 MHz; +13.00 dBm
 IF OUT: 30 MHz; -2.3 dBm

- Notes:
1. All Harmonics are in (dBc) relative to IF OUTPUT
 2. + entry denotes harmonics are in (dBc) above IF OUTPUT
 3. RF Cal represents the Harmonics level of the RF Input Signal to the mixer

DZ1650

Outline Dimensions

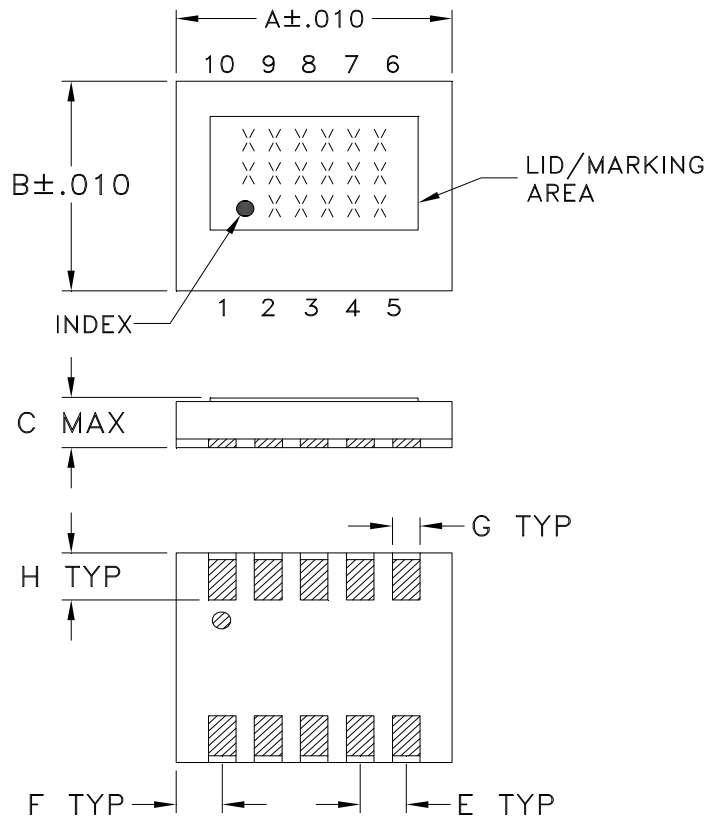

PCB Land Pattern

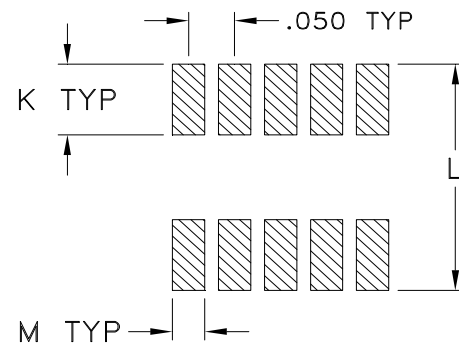

Suggested Layout,
Tolerance to be within $\pm .002$

CASE#	A	B	C	D	E	F	G	H	J	K	L	M	WT. GRAMS
DZ1650	.300 (7.62)	.250 (6.35)	.060 (1.52)	-- --	.050 (1.27)	.050 (1.27)	.030 (.76)	.056 (1.42)	-- --	.085 (2.16)	.270 (6.86)	.035 (.89)	.29

Dimensions are in inches (mm). Tolerances: 2Pl. $\pm .01$; 3Pl. $\pm .005$

Notes:

- Case material: Ceramic.
- Termination finish:
For RoHS Case Styles: 1.2 μ inch (0.03microns) Gold over 8 μ inch (0.2 microns) Palladium and 158 μ inch (4.0 microns) Nickel plate.
All models, (+) suffix.



INTERNET <http://www.minicircuits.com>

P.O. Box 350166, Brooklyn, New York 11235-0003 (718) 934-4500 Fax (718) 332-4661

Distribution Centers NORTH AMERICA 800-654-7949 • 417-335-5935 • Fax 417-335-5945 • EUROPE 44-1252-832600 • Fax 44-1252-837010

Mini-Circuits ISO 9001 & ISO 14001 Certified

Tape & Reel Packaging TR-F34

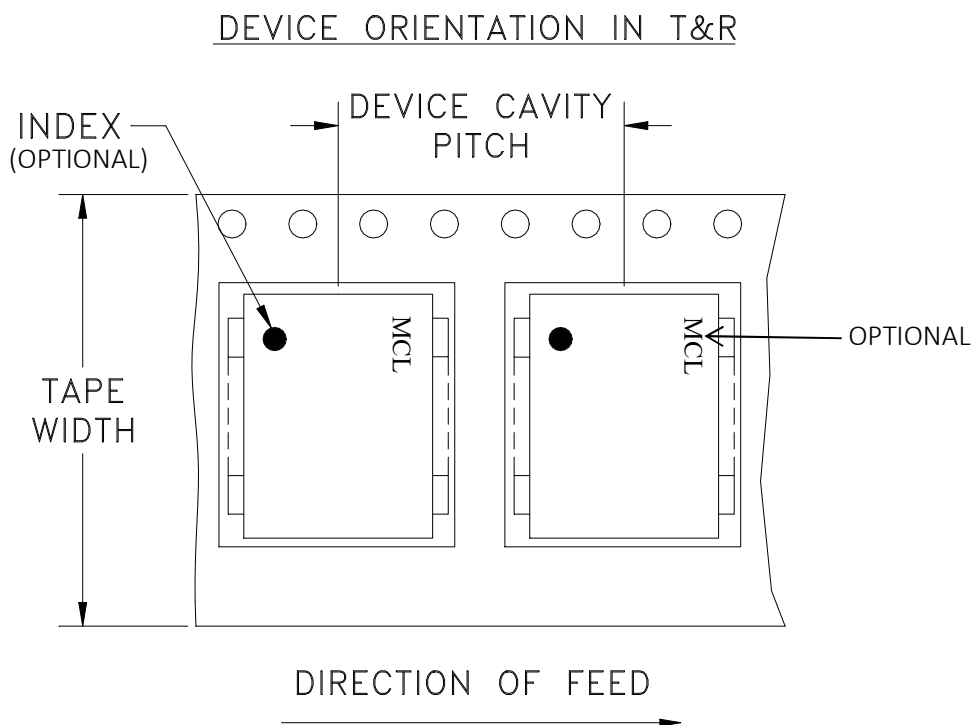

Tape Width, mm	Device Cavity Pitch, mm	Reel Size, inches	Devices per Reel see note	
16	12	7	Small quantity standard (see note)	20
				50
				100
				200
		13	Standard	500
				1000

Note: Availability of small reel quantity varies by model.
Refer to pricing and availability on individual model dashboard.

Mini-Circuits carrier tape materials provide protection from ESD (Electro-Static Discharge) during handling and transportation. Tapes are static dissipative and comply with industry standards EIA-481/EIA-541.

Go to: www.minicircuits.com/pages/pdfs/tape.pdf



INTERNET <http://www.minicircuits.com>

P.O. Box 350166, Brooklyn, New York 11235-0003 (718) 934-4500 Fax (718) 332-4661

Distribution Centers NORTH AMERICA 800-654-7949 • 417-335-5935 • Fax 417-335-5945 • EUROPE 44-1252-832600 • Fax 44-1252-837010

Mini-Circuits ISO 9001 & ISO 14001 Certified

THIRD ANGLE PROJECTION

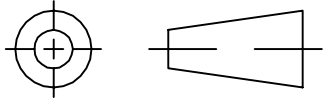

REVISIONS

REV	ECN No.	DESCRIPTION	DATE	DR	AUTH
A	M81781	UPDATED PCB LAYOUT	06/07/02	GF	DJ
B	M82377	UPDATED DRAWING	07/31/02	AV	WL
C	M102713	ADDED NOTE 2 & "...WITH SMOBC"	01/17/06	MMG	IL
D	M135488	ADDED DZ1650, CHANGED PIN CONN.	02/02/12	GF	DJ

SUGGESTED MOUNTING CONFIGURATION FOR
DZ883, DZ885 & DZ1650 CASE STYLES, "10MX01" PIN CONNECTION

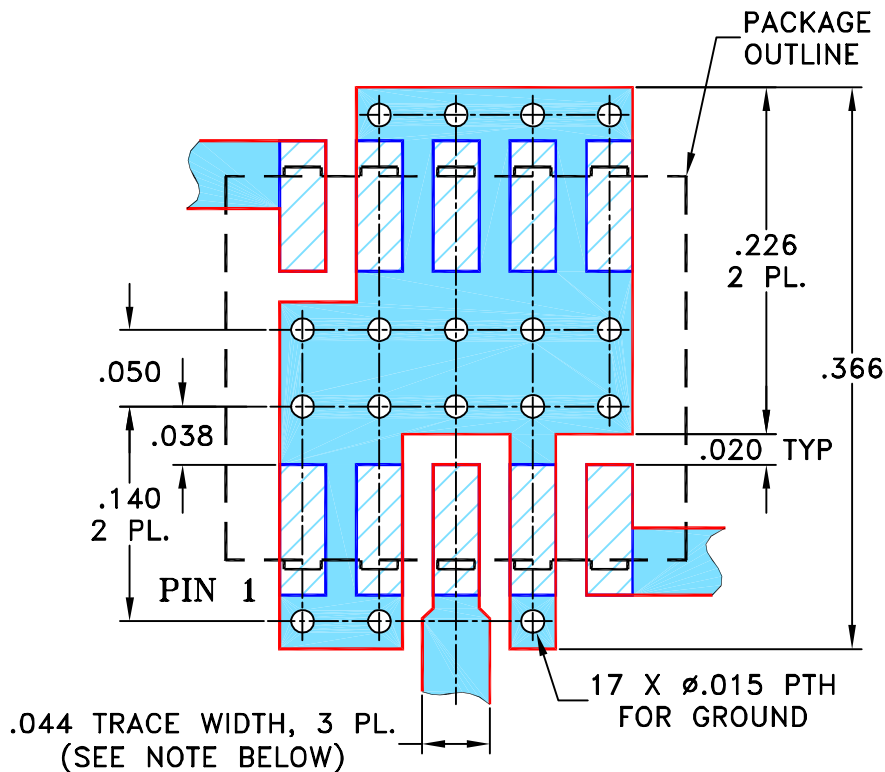

- NOTES: 1. TRACE WIDTH IS SHOWN FOR ROGERS R04350B WITH DIELECTRIC THICKNESS .020" ± .0015"; COPPER: 1/2 OZ. EACH SIDE. FOR OTHER MATERIALS TRACE WIDTH MAY NEED TO BE MODIFIED.
2. BOTTOM SIDE OF THE PCB IS CONTINUOUS GROUND PLANE.



DENOTES PCB COPPER LAYOUT WITH SMOBC (SOLDER MASK OVER BARE COPPER)



DENOTES COPPER LAND PATTERN FREE OF SOLDER MASK

UNLESS OTHERWISE SPECIFIED

INITIALS

DATE

DIMENSIONS ARE IN INCHES

DRAWN

AV

05/08/02

TOLERANCES ON:

CHECKED

DB

05/16/02

2 PL DECIMALS ± .005

APPROVED

WL

05/16/02

ANGLES ±

FRACTIONS ±

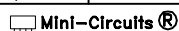

THIS DOCUMENT AND ITS CONTENTS ARE THE PROPERTY OF MINI-CIRCUITS. EXCEPT FOR USE EXPRESSLY GRANTED, IN WRITING, TO ITS VENDORS, VENDEE AND THE UNITED STATES GOVERNMENT, MINI-CIRCUITS RESERVES ALL PROPRIETARY DESIGN, USE, MANUFACTURING AND REPRODUCTION RIGHTS THERETO. THESE CONTENTS SHALL NOT BE USED, DUPLICATED OR DISCLOSED TO ANY OUTSIDE PARTY, IN WHOLE OR IN PART, WITHOUT WRITTEN PERMISSION OF MINI-CIRCUITS.



Mini-Circuits®

13 Neptune Avenue
Brooklyn NY 11235

PL, 10MX01, DZ883/885/1650, TB-144

SIZE

CODE IDENT

DRAWING NO:

REV:

A

15542

98-PL-045

D

FILE:

98PL045

SCALE:

8:1

SHEET:

1 OF 1

Evaluation Board and Circuit

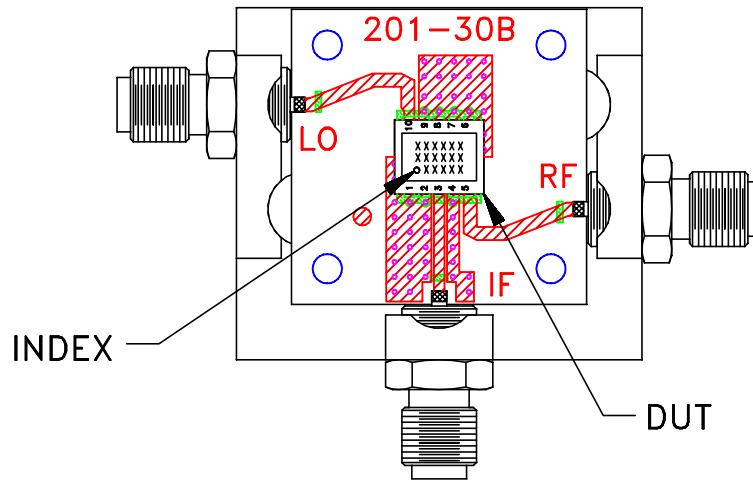

TB-956+

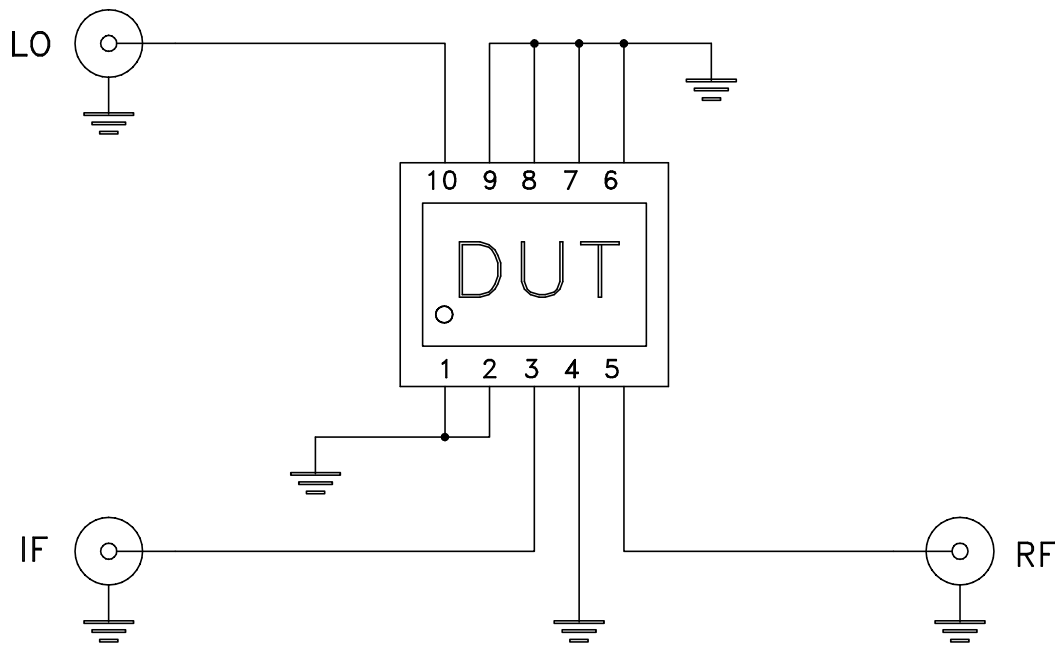

Schematic Diagram

Notes:

1. 50 Ohm SMA Female connectors.
2. PCB Material: R04350 or equivalent,
Dielectric Constant=3.5, Thickness=.020 inch.

 **Mini-Circuits®**

All Mini-Circuits products are manufactured under exacting quality assurance and control standards, and are capable of meeting published specifications after being subjected to any or all of the following physical and environmental test.

Specification	Test/Inspection Condition	Reference/Spec
Operating Temperature	-55° to 125° C Ambient Environment	Individual Model Data Sheet
Storage Temperature	-65° to 150° C Ambient Environment	Individual Model Data Sheet
Thermal Shock	-55° to 100° C, 1000 cycles, 15 minutes -55° to 150° C, 1000 cycles, 15 minutes	MIL-STD-202, Method 10
HTOL	1000 hrs, 125°, at rated Lo Level	MIL-STD-202, Method 108, Condition D
High Temp Storage	150°C 1008 hours	JESD22-A103
Resistance to Solvent	Per Reference Spec	MIL-STD-202, Method 215J
Fine and Gross Leak Test	Per Reference Spec	MIL-STD-202, Method 112 Test, Conditions C, D
Constant Acceleration	Y1 plane only, 30,000 g	MIL-STD-883, Method 2001, Condition E
Mechanical Shock	Per Reference Spec	MIL-STD-202, Method 213, Condition A
Vibration (High Frequency)	20g peak, 10-2000 Hz, 12 times in each of three perpendicular directions	MIL-STD-202, Method 204, Condition D
Solderability	3X, 245° peak temp	JESD22-B102
Bend Test	1MM, deflection for 5 secs.	JESD22-B113