

Engineering Development Model

Frequency Mixer

MACA-ED10457/8

Level -3 (LO Power -3 dBm)

Important Note

This model has been designed, built and tested in our engineering department. Performance data represents model capability. At present it is a non-catalog model. On request, we can supply a final specification sheet, part number and price/delivery information.



Please click "Back", and then click "Contact Us" for Applications support.

CASE STYLE : DZ1034

ELECTRICAL SPECIFICATIONS 50Ω @ +25°C					
Parameter		Min.	Typ.	Max.	Units
Frequency	LO (fL to fu)	500		2480	MHz
	RF (fL to fu)	500		2480	MHz
	IF	10		500	MHz
Conversion Loss	Total Range		6.95		dB
LO-RF Isolation			20		dB
LO-IF Isolation			51		dB
Input IP3			+20		dBm
1 dB Compression			+10		dBm

MAXIMUM RATINGS	
Operating Temperature	-40°C to 85°C
Storage Temperature	-55°C to +100°C

PIN CONNECTIONS	
LO	10
RF	5
IF	3
DC	7
GROUND EXT	1,2,4,6,8,9

Electrical Schematics

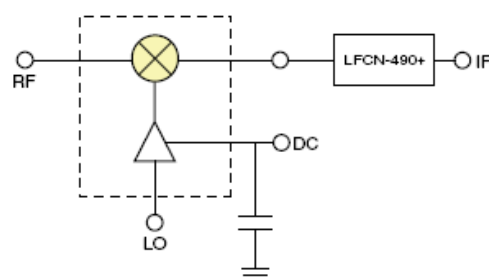

LFCN-490+ is added to improve L-I isolation.

Frequency Mixer

MACA-ED10457/8

Typical Performance Data

RF (IN) (MHz)	LO (MHz)	CONVERSION LOSS IF FIXED @IF(OUT)=30MHz (dB)			RF (IN) (MHz)	LO (MHz)	IP3 INPUT (dBm)			RF (IN) (MHz)	LO (MHz)	COMPRESSION @RF IN=+10dBm (dB)		
		@LO (dBm)					@LO (dBm)					@LO (dBm)		
		-6	-3	0			-6	-3	0			-6	-3	0
290.1	260.1	19.52	13.34	10.53	290.1	260.1	7.43	17.77	19.80	290.1	260.1	-11.45	0.80	1.40
360.1	330.1	8.50	7.12	6.25	360.1	330.1	14.36	15.57	18.22	360.1	330.1	2.62	2.37	1.80
430.1	400.1	7.58	6.78	6.19	430.1	400.1	10.99	13.45	15.37	430.1	400.1	3.24	2.23	1.50
500.1	470.1	8.19	6.99	6.26	500.1	470.1	14.19	16.59	18.85	500.1	470.1	1.61	1.67	1.45
570.1	540.1	8.47	7.76	7.27	570.1	540.1	16.70	18.76	19.30	570.1	540.1	0.60	0.64	0.59
640.1	610.1	7.10	6.86	6.73	640.1	610.1	16.06	17.00	17.72	640.1	610.1	0.92	0.84	0.75
710.1	680.1	6.18	5.95	5.73	710.1	680.1	24.06	21.84	20.64	710.1	680.1	0.48	0.41	0.38
780.1	750.1	7.70	7.38	7.06	780.1	750.1	18.34	22.21	24.71	780.1	750.1	0.92	0.82	0.68
850.1	820.1	8.62	8.01	7.54	850.1	820.1	21.95	27.98	23.21	850.1	820.1	0.18	0.32	0.39
920.1	890.1	7.27	7.13	6.94	920.1	890.1	22.25	24.16	25.48	920.1	890.1	0.54	0.39	0.32
990.1	960.1	6.44	6.43	6.32	990.1	960.1	19.45	21.03	22.59	990.1	960.1	0.54	0.41	0.41
1060.1	1030.1	7.17	7.22	7.26	1060.1	1030.1	20.88	22.63	24.02	1060.1	1030.1	0.34	0.28	0.22
1130.1	1100.1	8.60	8.32	8.02	1130.1	1100.1	27.78	31.68	28.77	1130.1	1100.1	0.53	0.38	0.34
1200.1	1170.1	8.07	7.78	7.69	1200.1	1170.1	27.82	24.24	24.35	1200.1	1170.1	0.51	0.34	0.22
1280.1	1250.1	8.58	7.98	7.68	1280.1	1250.1	20.43	24.77	27.57	1280.1	1250.1	0.11	0.26	0.26
1350.1	1320.1	7.83	7.24	6.92	1350.1	1320.1	15.00	16.73	17.66	1350.1	1320.1	0.89	0.92	0.86
1430.1	1400.1	6.26	6.06	5.88	1430.1	1400.1	12.91	13.65	13.87	1430.1	1400.1	1.83	1.76	1.65
1500.1	1470.1	5.86	5.81	5.66	1500.1	1470.1	12.69	13.28	13.44	1500.1	1470.1	2.19	1.87	1.66
1580.1	1550.1	5.85	5.60	5.40	1580.1	1550.1	17.48	18.63	18.49	1580.1	1550.1	1.51	1.22	0.98
1650.1	1620.1	5.52	5.42	5.35	1650.1	1620.1	20.02	21.23	21.04	1650.1	1620.1	1.08	0.67	0.50
1730.1	1700.1	5.91	5.87	5.88	1730.1	1700.1	23.54	24.76	26.16	1730.1	1700.1	0.60	0.29	0.15
1800.1	1770.1	6.23	5.98	5.78	1800.1	1770.1	17.81	20.68	23.54	1800.1	1770.1	1.31	0.90	0.60
1880.1	1850.1	6.49	5.96	5.62	1880.1	1850.1	17.21	18.86	22.03	1880.1	1850.1	1.63	1.08	0.69
1950.1	1920.1	8.26	6.88	6.12	1950.1	1920.1	11.64	13.83	15.03	1950.1	1920.1	1.84	1.96	1.80
2030.1	2000.1	9.19	7.65	6.98	2030.1	2000.1	14.31	16.48	17.04	2030.1	2000.1	1.08	1.32	1.20
2100.1	2070.1	8.63	7.54	7.05	2100.1	2070.1	15.05	16.17	16.03	2100.1	2070.1	0.96	1.03	0.94
2180.1	2150.1	8.32	7.50	7.06	2180.1	2150.1	20.44	20.83	21.11	2180.1	2150.1	0.78	0.80	0.74
2250.1	2220.1	7.99	7.32	6.87	2250.1	2220.1	17.59	20.14	21.13	2250.1	2220.1	0.69	0.63	0.53
2330.1	2300.1	7.64	7.01	6.65	2330.1	2300.1	21.88	23.80	25.33	2330.1	2300.1	0.84	0.54	0.36
2400.1	2370.1	7.92	6.84	6.27	2400.1	2370.1	17.13	20.00	22.75	2400.1	2370.1	1.13	0.79	0.48
2480.1	2450.1	9.52	8.03	6.86	2480.1	2450.1	10.61	13.96	16.89	2480.1	2450.1	1.84	1.52	1.33
2550.1	2520.1	12.28	9.98	8.64	2550.1	2520.1	18.26	17.11	17.51	2550.1	2520.1	0.86	1.21	1.06
2630.1	2600.1	14.69	10.75	9.01	2630.1	2600.1	12.35	21.21	23.63	2630.1	2600.1	-2.07	0.25	0.59
2700.1	2670.1	13.64	10.97	9.38	2700.1	2670.1	13.79	21.63	21.46	2700.1	2670.1	-1.35	0.03	0.41
2780.1	2750.1	11.50	9.63	8.65	2780.1	2750.1	15.43	26.70	23.88	2780.1	2750.1	-0.33	0.31	0.36
2850.1	2820.1	11.38	9.43	8.24	2850.1	2820.1	13.89	20.08	24.00	2850.1	2820.1	-0.31	0.44	0.59
2930.1	2900.1	11.76	9.57	7.99	2930.1	2900.1	13.26	17.46	18.20	2930.1	2900.1	-0.38	0.47	0.70
3000.1	2970.1	12.01	10.16	8.53	3000.1	2970.1	15.40	16.82	17.49	3000.1	2970.1	0.25	0.36	0.49
3080.1	3050.1	12.10	10.86	9.14	3080.1	3050.1	14.59	16.36	17.35	3080.1	3050.1	1.90	1.08	1.07
3150.1	3120.1	12.83	12.71	11.20	3150.1	3120.1	12.42	16.09	17.59	3150.1	3120.1	3.13	1.52	1.40

Frequency Mixer

MACA-ED10457/8

Typical Performance Data

IF (OUT) (MHz)	LO (MHz)	CONVERSION LOSS VS. IF FREQUENCY @RF(IN)=1575.1MHz (dB)	IF (OUT) (MHz)	LO (MHz)	CONVERSION LOSS VS. IF FREQUENCY @RF(IN)=750.1MHz (dB)	IF (OUT) (MHz)	LO (MHz)	CONVERSION LOSS VS. IF FREQUENCY @RF(IN)=2400.1001MHz (dB)
		@LO (dBm)			@LO (dBm)			@LO (dBm)
		-3			-3			-3
635.0	940.1	13.05	10.0	760.1	6.68	650.1	1750.0	14.38
594.7	980.4	9.88	30.0	780.1	6.97	630.1	1770.0	11.79
554.4	1020.7	8.83	50.0	800.1	7.59	610.1	1790.0	10.29
514.0	1061.1	7.98	70.0	820.1	7.97	590.1	1810.0	9.68
473.7	1101.4	7.41	90.0	840.1	8.26	570.1	1830.0	9.57
433.4	1141.7	7.63	110.0	860.1	8.34	550.1	1850.0	9.64
393.1	1182.0	7.16	130.0	880.1	8.48	530.1	1870.0	9.69
352.7	1222.4	6.53	150.0	900.1	8.42	510.1	1890.0	9.85
312.4	1262.7	6.03	170.0	920.1	8.40	490.1	1910.0	10.02
272.1	1303.0	5.58	190.0	940.1	8.28	470.1	1930.0	10.13
231.8	1343.3	5.39	210.0	960.1	8.01	450.1	1950.0	10.10
211.6	1363.5	5.30	230.0	980.1	7.58	430.1	1970.0	9.93
171.3	1403.8	5.08	250.0	1000.1	7.38	410.1	1990.0	9.84
151.1	1424.0	5.13	260.0	1010.1	7.21	400.1	2000.0	9.79
110.8	1464.3	5.31	280.0	1030.1	7.09	380.1	2020.0	9.74
90.6	1484.5	5.36	290.0	1040.1	7.07	370.1	2030.0	9.75
50.3	1524.8	5.59	310.0	1060.1	7.05	350.1	2050.0	9.66
30.2	1544.9	5.57	320.0	1070.1	7.13	340.1	2060.0	9.58
10.0	1585.1	5.59	340.0	1090.1	6.91	320.1	2080.0	9.47
30.5	1605.6	5.36	350.0	1100.1	6.75	310.1	2090.0	9.30
71.5	1646.6	5.30	370.0	1120.1	6.61	290.1	2110.0	9.16
91.9	1667.0	5.41	380.0	1130.1	6.66	280.1	2120.0	9.07
132.9	1708.0	5.61	400.0	1150.1	6.69	260.1	2140.0	8.81
153.4	1728.5	5.79	410.0	1160.1	6.82	250.1	2150.0	8.70
194.4	1769.5	6.14	430.0	1180.1	7.15	230.1	2170.0	8.46
214.8	1789.9	6.30	440.0	1190.1	7.21	220.1	2180.0	8.26
255.8	1830.9	6.73	460.0	1210.1	7.52	200.1	2200.0	7.98
276.3	1851.4	6.93	470.0	1220.1	7.67	190.1	2210.0	7.86
317.3	1892.4	7.44	490.0	1240.1	7.99	170.1	2230.0	7.60
337.7	1912.8	7.81	500.0	1250.1	8.13	160.1	2240.0	7.50
378.7	1953.8	8.48	520.0	1270.1	8.31	140.1	2260.0	7.31
399.2	1974.3	8.64	530.0	1280.1	8.29	130.1	2270.0	7.18
440.2	2015.3	9.18	550.0	1300.1	8.47	110.1	2290.0	7.00
460.6	2035.7	9.58	560.0	1310.1	8.61	100.1	2300.0	6.95
501.6	2076.7	9.23	580.0	1330.1	8.89	80.1	2320.0	6.81
522.1	2097.2	8.93	590.0	1340.1	9.18	70.1	2330.0	6.77
563.1	2138.2	8.56	610.0	1360.1	9.92	50.1	2350.0	6.83
583.5	2158.6	8.59	620.0	1370.1	10.56	40.1	2360.0	6.79
624.5	2199.6	10.73	640.0	1390.1	12.95	20.1	2380.0	6.89
645.0	2220.1	13.24	650.0	1400.1	14.56	10.1	2390.0	6.97

REV. X2

MACA-ED10457/8

101012

Page 2 of 5



IF/RF MICROWAVE COMPONENTS • ISO 9001 ISO 14001 AS9100 CERTIFIED RoHS compliant
P.O. Box 350166, Brooklyn, New York 11235-0006 (718) 934-4500 Fax (718) 332-4661



The Design Engineers Search Engine finds the model you need, instantly • For detailed performance specs & shopping online see



Frequency Mixer

MACA-ED10457/8

Typical Performance Data

LO (MHz)	LO-RF ISOLATION (dB)			LO-IF ISOLATION (dB)			RF (IN) (MHz)	LO (MHz)	RF-IF ISOLATION (dB)		
	@LO (dBm)			@LO (dBm)					@LO (dBm)		
	-6	-3	0	-6	-3	0			-6	-3	0
260.1	35.10	33.85	31.80	5.79	7.13	7.61	290.1	260.1	25.45	23.97	22.14
330.1	25.81	28.28	28.45	3.03	5.36	7.15	360.1	330.1	20.89	19.53	18.22
400.1	29.92	28.01	25.87	3.26	5.81	8.10	430.1	400.1	19.92	17.39	15.88
470.1	23.42	23.87	24.35	3.75	6.12	8.23	500.1	470.1	17.25	16.76	16.55
540.1	23.61	24.88	25.94	4.97	7.53	10.07	570.1	540.1	21.33	21.14	21.42
610.1	31.99	39.57	49.38	6.54	7.00	7.63	640.1	610.1	29.52	29.47	31.60
680.1	20.67	20.76	21.07	20.61	21.49	22.01	710.1	680.1	48.28	46.98	44.53
750.1	20.30	21.29	20.93	42.08	42.35	42.82	780.1	750.1	65.71	65.04	63.38
820.1	21.85	21.59	20.58	56.20	55.69	55.99	850.1	820.1	67.31	67.53	67.84
890.1	20.16	22.18	22.08	44.48	44.47	44.80	920.1	890.1	66.65	68.14	68.97
960.1	19.26	19.65	18.36	32.67	33.36	34.13	990.1	960.1	67.73	68.18	70.04
1030.1	21.45	22.94	20.56	39.98	41.59	43.09	1060.1	1030.1	70.51	71.06	69.98
1100.1	27.45	33.19	24.60	46.97	48.98	50.91	1130.1	1100.1	70.20	70.98	71.04
1170.1	23.73	39.27	26.36	52.00	54.05	56.21	1200.1	1170.1	72.07	71.50	72.70
1250.1	23.29	31.68	22.19	58.26	60.12	61.90	1280.1	1250.1	75.16	76.16	76.41
1320.1	19.60	22.48	23.84	75.60	79.77	82.53	1350.1	1320.1	84.01	84.24	87.71
1400.1	10.95	11.56	11.85	55.92	57.83	59.62	1430.1	1400.1	77.97	77.36	76.82
1470.1	14.73	16.30	17.40	47.28	50.43	53.45	1500.1	1470.1	74.30	75.07	78.37
1550.1	15.58	14.88	14.71	51.54	55.61	59.46	1580.1	1550.1	83.03	90.00	83.21
1620.1	13.52	13.22	13.40	51.46	55.98	60.21	1650.1	1620.1	87.40	86.89	81.22
1700.1	14.70	13.82	13.47	50.06	54.58	58.96	1730.1	1700.1	79.76	79.73	81.98
1770.1	16.50	16.88	17.72	51.90	55.14	59.12	1800.1	1770.1	77.14	76.89	76.93
1850.1	15.69	16.43	17.80	56.83	55.95	56.43	1880.1	1850.1	72.56	71.11	70.38
1920.1	15.39	15.62	16.15	63.84	59.88	57.37	1950.1	1920.1	71.07	69.00	68.82
2000.1	14.62	13.91	13.96	67.88	70.94	68.74	2030.1	2000.1	69.79	69.47	68.57
2070.1	13.79	13.46	12.68	67.68	73.61	78.26	2100.1	2070.1	68.02	66.98	67.88
2150.1	16.32	18.47	19.70	71.23	76.11	81.74	2180.1	2150.1	65.74	66.00	65.51
2220.1	14.17	14.85	15.27	70.09	74.38	80.33	2250.1	2220.1	66.10	66.20	66.13
2300.1	14.85	16.13	16.91	65.10	70.06	73.83	2330.1	2300.1	64.68	66.01	66.73
2370.1	14.95	17.26	18.52	62.44	65.49	68.43	2400.1	2370.1	65.70	66.88	67.05
2450.1	14.48	18.18	24.48	58.07	60.95	63.49	2480.1	2450.1	64.69	66.13	66.00
2520.1	13.02	20.20	23.84	54.94	59.88	63.64	2550.1	2520.1	64.41	64.44	64.49
2600.1	13.00	16.06	15.74	50.02	50.56	50.85	2630.1	2600.1	62.72	64.55	65.84
2670.1	12.11	10.00	8.48	48.43	47.42	47.07	2700.1	2670.1	70.45	67.76	67.81
2750.1	19.72	14.55	11.64	57.92	53.67	52.03	2780.1	2750.1	67.21	65.26	63.82
2820.1	20.91	17.43	14.06	62.27	56.52	54.65	2850.1	2820.1	63.60	62.20	61.38
2900.1	20.57	19.66	19.53	59.89	57.70	57.50	2930.1	2900.1	60.39	59.92	59.35
2970.1	21.96	20.26	20.06	56.99	57.46	58.47	3000.1	2970.1	57.90	57.92	57.73
3050.1	18.16	17.91	17.76	52.81	55.21	56.83	3080.1	3050.1	56.24	56.31	56.34
3120.1	16.20	17.85	18.10	50.98	54.05	56.07	3150.1	3120.1	55.18	55.15	54.93

Frequency Mixer

MACA-ED10457/8

Typical Performance Data

RF (IN) (MHz)	LO (MHz)	RF VSWR (:1)			LO (MHz)	LO VSWR (:1)			IF (OUT) (MHz)	IF VSWR @LO=2400.1001MHz (:1)		
		@LO (dBm)				@LO (dBm)				@LO (dBm)		
		-6	-3	0		-6	-3	0		-6	-3	0
290.1	260.1	7.22	3.87	3.14	260.1	5.65	5.61	5.63	10.0	1.53	1.10	1.07
360.1	330.1	2.20	1.79	1.77	330.1	5.27	5.30	5.36	30.0	1.53	1.10	1.08
430.1	400.1	1.99	1.71	1.66	400.1	4.18	4.33	4.40	50.0	1.56	1.12	1.05
500.1	470.1	3.58	3.02	2.73	470.1	3.98	3.93	3.88	70.0	1.56	1.13	1.06
570.1	540.1	4.77	4.43	4.26	540.1	3.73	3.57	3.44	90.0	1.61	1.17	1.04
640.1	610.1	3.92	3.82	3.79	610.1	3.29	3.17	3.05	110.0	1.61	1.17	1.06
710.1	680.1	3.16	2.82	2.62	680.1	2.93	2.89	2.82	130.0	1.64	1.21	1.09
780.1	750.1	4.00	3.65	3.38	750.1	2.57	2.60	2.57	150.0	1.67	1.23	1.09
850.1	820.1	6.05	5.51	5.10	820.1	2.40	2.44	2.42	170.0	1.75	1.30	1.14
920.1	890.1	4.32	4.10	3.90	890.1	2.28	2.32	2.33	190.0	1.81	1.35	1.19
990.1	960.1	3.03	2.84	2.71	960.1	2.20	2.23	2.25	210.0	1.87	1.42	1.25
1060.1	1030.1	3.06	3.03	2.99	1030.1	2.00	2.02	2.04	230.0	1.94	1.47	1.29
1130.1	1100.1	5.51	5.38	5.28	1100.1	2.10	2.06	2.05	250.0	2.04	1.57	1.37
1200.1	1170.1	5.59	5.23	5.04	1170.1	2.07	2.03	2.02	260.0	2.09	1.61	1.40
1280.1	1250.1	4.80	4.59	4.50	1250.1	2.02	2.00	2.03	280.0	2.16	1.68	1.48
1350.1	1320.1	4.05	3.86	3.80	1320.1	1.99	2.04	2.11	290.0	2.17	1.69	1.48
1430.1	1400.1	2.74	2.48	2.32	1400.1	2.07	2.20	2.33	310.0	2.24	1.74	1.51
1500.1	1470.1	2.16	1.95	1.79	1470.1	2.26	2.46	2.68	320.0	2.26	1.76	1.53
1580.1	1550.1	1.45	1.33	1.26	1550.1	2.44	2.60	2.79	340.0	2.35	1.84	1.59
1650.1	1620.1	1.19	1.22	1.25	1620.1	2.60	2.70	2.82	350.0	2.42	1.89	1.64
1730.1	1700.1	1.56	1.72	1.87	1700.1	2.84	2.77	2.80	370.0	2.49	1.95	1.69
1800.1	1770.1	1.47	1.57	1.62	1770.1	2.95	2.80	2.73	380.0	2.57	2.03	1.75
1880.1	1850.1	1.17	1.08	1.23	1850.1	2.92	2.75	2.66	400.0	2.67	2.10	1.82
1950.1	1920.1	1.89	1.55	1.37	1920.1	2.75	2.60	2.53	410.0	2.75	2.16	1.86
2030.1	2000.1	2.79	2.44	2.32	2000.1	2.52	2.38	2.33	430.0	2.88	2.28	1.97
2100.1	2070.1	2.87	2.59	2.53	2070.1	2.18	2.10	2.12	440.0	2.92	2.32	2.00
2180.1	2150.1	2.97	2.69	2.60	2150.1	1.71	1.74	1.86	460.0	3.06	2.45	2.13
2250.1	2220.1	3.06	2.82	2.73	2220.1	1.38	1.49	1.67	470.0	3.07	2.45	2.13
2330.1	2300.1	2.85	2.58	2.51	2300.1	1.20	1.33	1.52	490.0	3.11	2.51	2.19
2400.1	2370.1	2.69	2.22	2.04	2370.1	1.36	1.36	1.46	500.0	3.09	2.49	2.18
2480.1	2450.1	3.20	2.43	2.02	2450.1	1.63	1.58	1.57	520.0	2.92	2.37	2.10
2550.1	2520.1	4.28	3.57	3.31	2520.1	1.77	1.72	1.73	530.0	2.82	2.31	2.05
2630.1	2600.1	4.91	4.09	3.78	2600.1	1.55	1.46	1.45	550.0	2.41	2.01	1.81
2700.1	2670.1	4.86	4.03	3.69	2670.1	1.54	1.46	1.45	560.0	2.18	1.84	1.67
2780.1	2750.1	4.43	3.73	3.47	2750.1	1.25	1.24	1.26	580.0	1.59	1.36	1.28
2850.1	2820.1	4.15	3.42	3.06	2820.1	1.14	1.12	1.14	590.0	1.33	1.14	1.11
2930.1	2900.1	4.08	3.25	2.81	2900.1	1.22	1.18	1.13	610.0	1.50	1.44	1.43
3000.1	2970.1	3.90	3.26	2.85	2970.1	1.37	1.32	1.25	620.0	1.97	1.87	1.82
3080.1	3050.1	3.77	3.28	2.86	3050.1	1.55	1.48	1.39	640.0	3.49	3.24	3.09
3150.1	3120.1	3.98	3.82	3.52	3120.1	1.61	1.57	1.47	650.0	4.45	4.13	3.94

Harmonics Tables

RF HARMONICS ORDER

	(-dBm)	(dBc)										
0	-	-	45	59	23	34	37	35	42	73	36	55
1	-	79	+0	77	65	66	40	66	40	64	60	52
2	67	>79	>79	48	>79	>79	64	68	68	74	70	>79
3	>90	>79	>79	>79	54	>79	>79	>79	78	>79	74	>79
4	>90	>79	>79	>79	>79	76	>79	>79	>79	>79	>79	>79
5	>90	>79	>79	>79	>79	>79	>79	>79	>79	>79	>79	>79
6	>90	>79	>79	>79	>79	>79	>79	>79	>79	>79	>79	>79
7	>90	>79	>79	>79	>79	>79	>79	>79	>79	>79	>79	>79
8	>90	>79	>79	>79	>79	>79	>79	>79	>79	>79	>79	>79
9	>90	>79	>79	>79	>79	>79	>79	>79	>79	>79	>79	>79
10	>90	>79	>79	>79	>79	>79	>79	>79	>79	>79	>79	>79
	RF CAL	0	1	2	3	4	5	6	7	8	9	10

LO HARMONICS ORDER

Test conditions: RF IN: 1575.1 MHz; -5.00 dBm.
 LO IN: 1545.1 MHz; +-3.00 dBm
 IF OUT: 30 MHz; -10.5 dBm

RF HARMONICS ORDER

	(-dBm)	(dBc)										
0	-	-	57	70	35	47	54	47	56	77	51	66
1	-	79	+0	76	66	68	42	67	42	71	65	59
2	47	>89	86	37	75	>89	55	61	63	68	73	>89
3	87	84	>89	>89	33	>89	>89	80	63	83	64	84
4	>90	76	79	>89	>89	58	>89	>89	73	78	78	>89
5	>90	83	78	>89	>89	>89	52	>89	>89	>89	77	>89
6	>90	85	84	>89	>89	>89	>89	77	>89	>89	>89	>89
7	>90	>89	84	>89	88	>89	>89	>89	68	>89	>89	>89
8	>90	>89	>89	>89	>89	>89	>89	>89	>89	76	>89	>89
9	>90	>89	>89	>89	>89	>89	>89	>89	>89	>89	79	>89
10	>90	>89	>89	>89	>89	>89	>89	>89	>89	>89	>89	80
	RF CAL	0	1	2	3	4	5	6	7	8	9	10

LO HARMONICS ORDER

Test conditions: RF IN: 1575.1 MHz; 5.00 dBm.
 LO IN: 1545.1 MHz; +-3.00 dBm
 IF OUT: 30 MHz; -0.78 dBm

- Notes: 1. All Harmonics are in (dBc) relative to IF OUTPUT.
 2. + entry denotes harmonics are in (dBc) above IF OUTPUT.
 3. RF Cal represent the Harmonics level of the RF input signal to the mixer.

Typical Performance Curves

Conversion Loss @ IF=30MHz

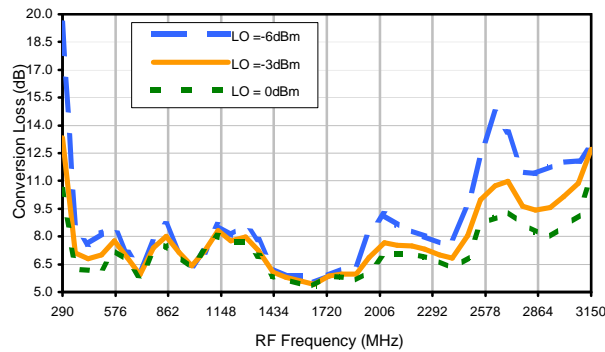

Conversion Loss vs. LO @ RF=1575.1MHz

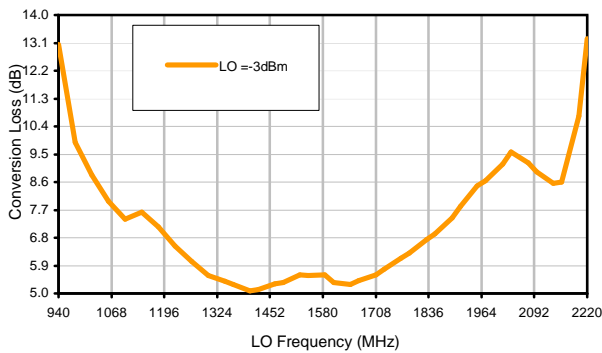

Conversion Loss vs. IF @ RF=1575.1MHz

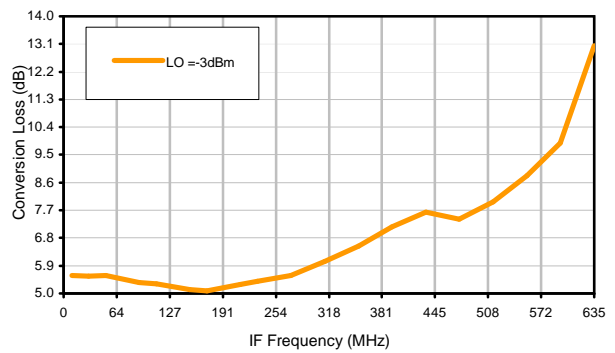

Conversion Loss vs. IF @ RF=750.1MHz

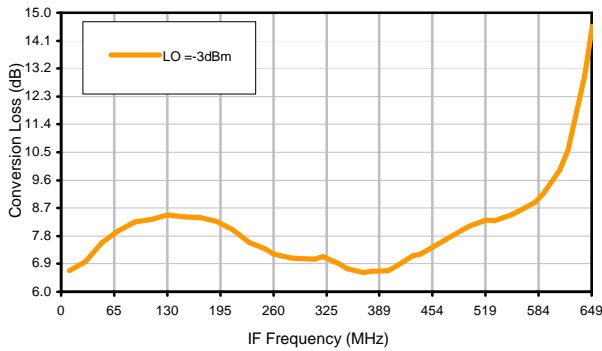

Conversion Loss vs. IF @ RF=2400.1001MHz

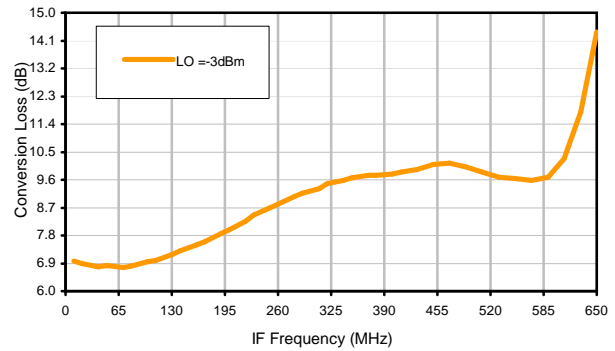

IP3 Input

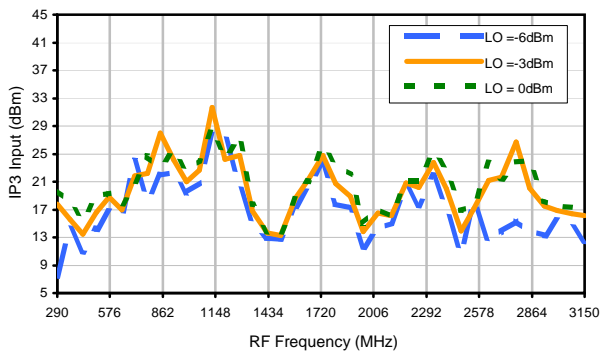

Compression @ RF IN=+10dBm

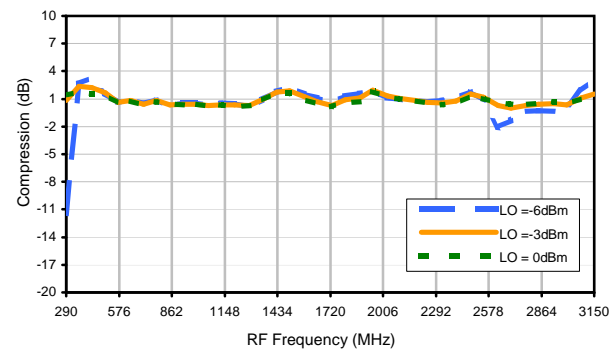

Typical Performance Curves

LO-RF Isolation

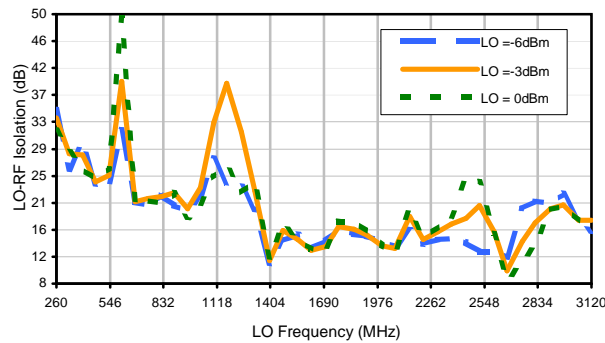

LO-IF Isolation

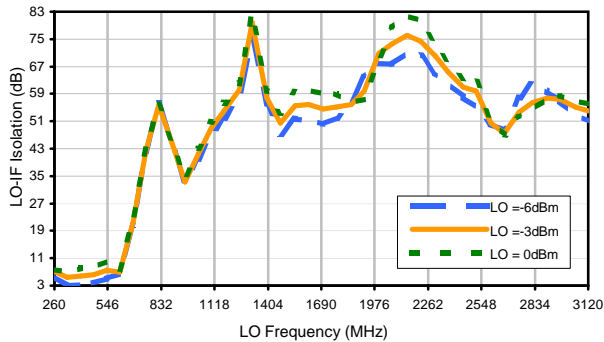

RF-IF Isolation

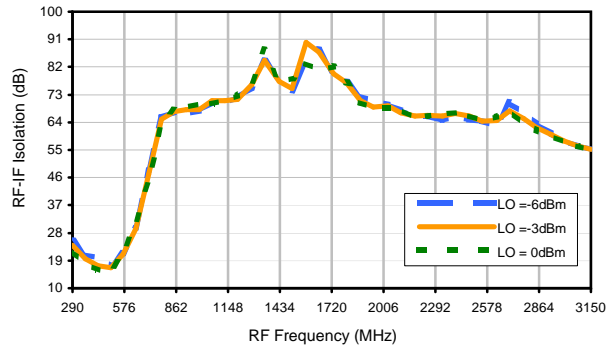

RF VSWR

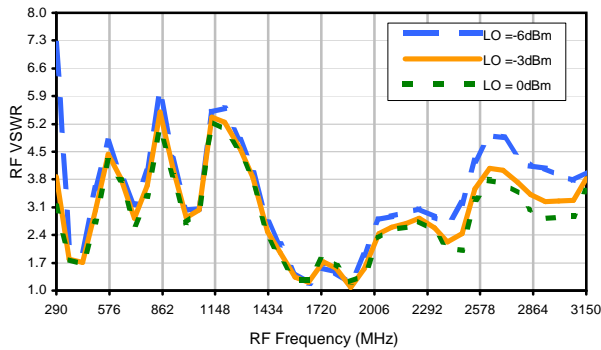

LO VSWR

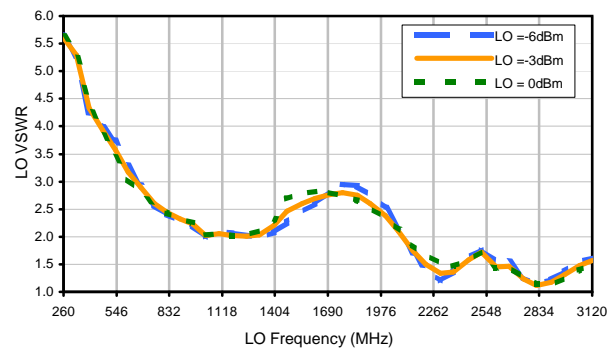

IF VSWR

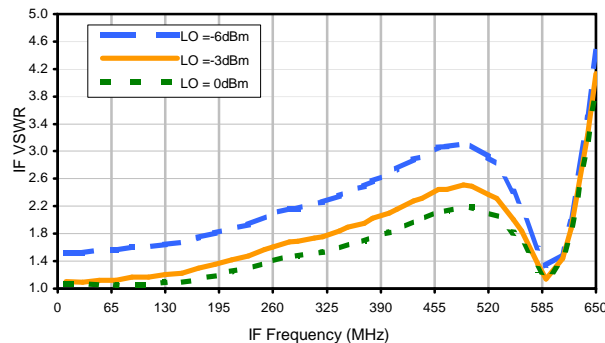

Harmonics Tables

RF HARMONICS ORDER

	(-dBm)	(-dBc)										
0	-	-	45	59	23	34	37	35	42	73	36	55
1	-	79	+0	77	65	66	40	66	40	64	60	52
2	67	>79	>79	48	>79	>79	64	68	68	74	70	>79
3	>90	>79	>79	>79	54	>79	>79	>79	78	>79	74	>79
4	>90	>79	>79	>79	>79	76	>79	>79	>79	>79	>79	>79
5	>90	>79	>79	>79	>79	>79	>79	>79	>79	>79	>79	>79
6	>90	>79	>79	>79	>79	>79	>79	>79	>79	>79	>79	>79
7	>90	>79	>79	>79	>79	>79	>79	>79	>79	>79	>79	>79
8	>90	>79	>79	>79	>79	>79	>79	>79	>79	>79	>79	>79
9	>90	>79	>79	>79	>79	>79	>79	>79	>79	>79	>79	>79
10	>90	>79	>79	>79	>79	>79	>79	>79	>79	>79	>79	>79
	RF CAL	0	1	2	3	4	5	6	7	8	9	10

LO HARMONICS ORDER

Test conditions: RF IN: 1575.1 MHz; -5.00 dBm.
 LO IN: 1545.1 MHz; +-3.00 dBm
 IF OUT: 30 MHz; -10.5 dBm

RF HARMONICS ORDER

	(-dBm)	(-dBc)										
0	-	-	57	70	35	47	54	47	56	77	51	66
1	-	79	+0	76	66	68	42	67	42	71	65	59
2	47	>89	86	37	75	>89	55	61	63	68	73	>89
3	87	84	>89	>89	33	>89	>89	80	63	83	64	84
4	>90	76	79	>89	>89	58	>89	>89	73	78	78	>89
5	>90	83	78	>89	>89	>89	52	>89	>89	>89	77	>89
6	>90	85	84	>89	>89	>89	>89	77	>89	>89	>89	>89
7	>90	>89	84	>89	88	>89	>89	>89	68	>89	>89	>89
8	>90	>89	>89	>89	>89	>89	>89	>89	>89	76	>89	>89
9	>90	>89	>89	>89	>89	>89	>89	>89	>89	>89	79	>89
10	>90	>89	>89	>89	>89	>89	>89	>89	>89	>89	>89	80
	RF CAL	0	1	2	3	4	5	6	7	8	9	10

LO HARMONICS ORDER

Test conditions: RF IN: 1575.1 MHz; 5.00 dBm.
 LO IN: 1545.1 MHz; +-3.00 dBm
 IF OUT: 30 MHz; -0.78 dBm

- Notes: 1. All Harmonics are in (dBc) relative to IF OUTPUT.
 2. + entry denotes harmonics are in (dBc) above IF OUTPUT.
 3. RF Cal represent the Harmonics level of the RF input signal to the mixer.

Outline Dimensions

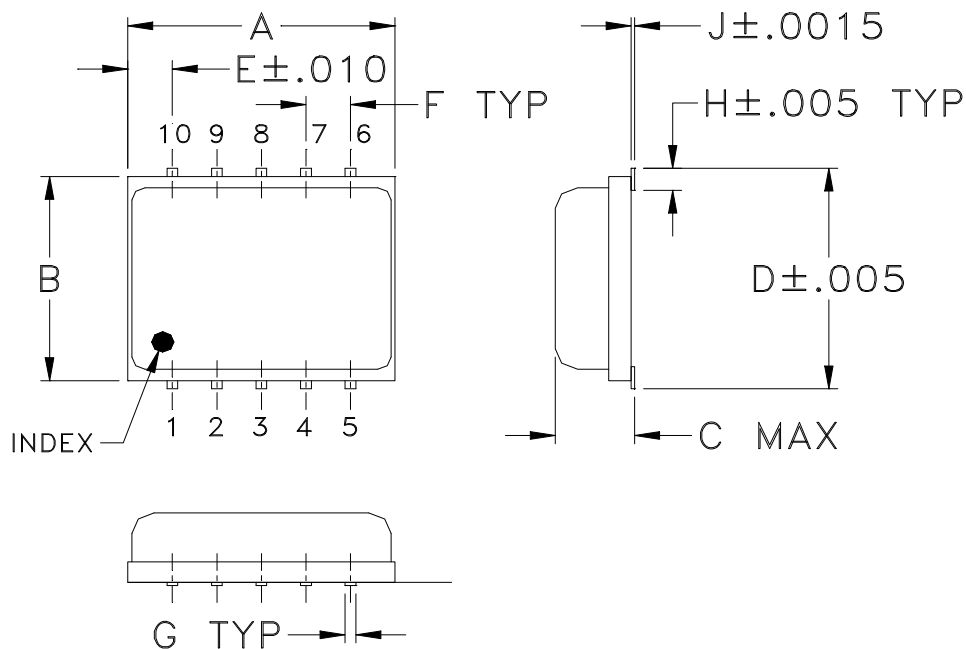

PCB Land Pattern

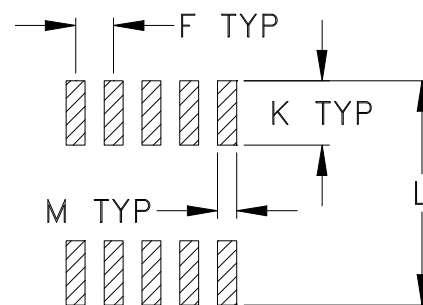

Suggested Layout,
Tolerance to be within $\pm .002$

CASE#	A	B	C	D	E	F	G	H	J	K	L	M	WT. GRAMS
DZ885	.30 (7.62)	.250 (6.35)	.085 (2.16)	.266 (6.76)	.050 (1.27)	.050 (1.27)	.012 (0.30)	.029 (0.74)	.004 (0.10)	.085 (2.16)	.296 (7.52)	.030 (0.76)	0.25
DZ1034			.105 (2.67)										0.3

Dimensions are in inches (mm). Tolerances: 2Pl. $\pm .01$; 3Pl. $\pm .005$

Notes:

- Case material: Plastic encapsulation on Ceramic base.
- Termination finish:
 - For RoHS Case Styles: Tin plate. All models, (+) suffix.
 - For RoHS-5 Case Styles: Tin-Lead plate. All models, no (+) suffix.

Tape & Reel Packaging TR-F34



Tape Width, mm	Device Cavity Pitch, mm	Reel Size, inches	Devices per Reel see note	
16	12	7	Small quantity standard (see note)	20
				50
				100
				200
		13	Standard	500
				1000

Note: Availability of small reel quantity varies by model.
Refer to pricing and availability on individual model dashboard.

Mini-Circuits carrier tape materials provide protection from ESD (Electro-Static Discharge) during handling and transportation. Tapes are static dissipative and comply with industry standards EIA-481/EIA-541.

Go to: www.minicircuits.com/pages/pdfs/tape.pdf



INTERNET <http://www.minicircuits.com>

P.O. Box 350166, Brooklyn, New York 11235-0003 (718) 934-4500 Fax (718) 332-4661

Distribution Centers NORTH AMERICA 800-654-7949 • 417-335-5935 • Fax 417-335-5945 • EUROPE 44-1252-832600 • Fax 44-1252-837010

Mini-Circuits ISO 9001 & ISO 14001 Certified

THIRD ANGLE PROJECTION

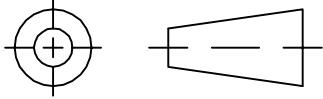

REVISIONS

REV	ECN No.	DESCRIPTION	DATE	DR	AUTH
OR	M89275	NEW RELEASE	10/23/03	AV	DJ
A	M91639	REMOVED NOTE 2	04/14/04	AV	DJ
B	M102713	ADDED "...WITH SMOBC"	01/12/06	GF	IL
C	M115195	MODIFIED PATTERN & TEST BOARD	12/24/07	AV	DJ

SUGGESTED MOUNTING CONFIGURATION FOR
DZ1034 CASE STYLE, "10MA01" PIN CODE

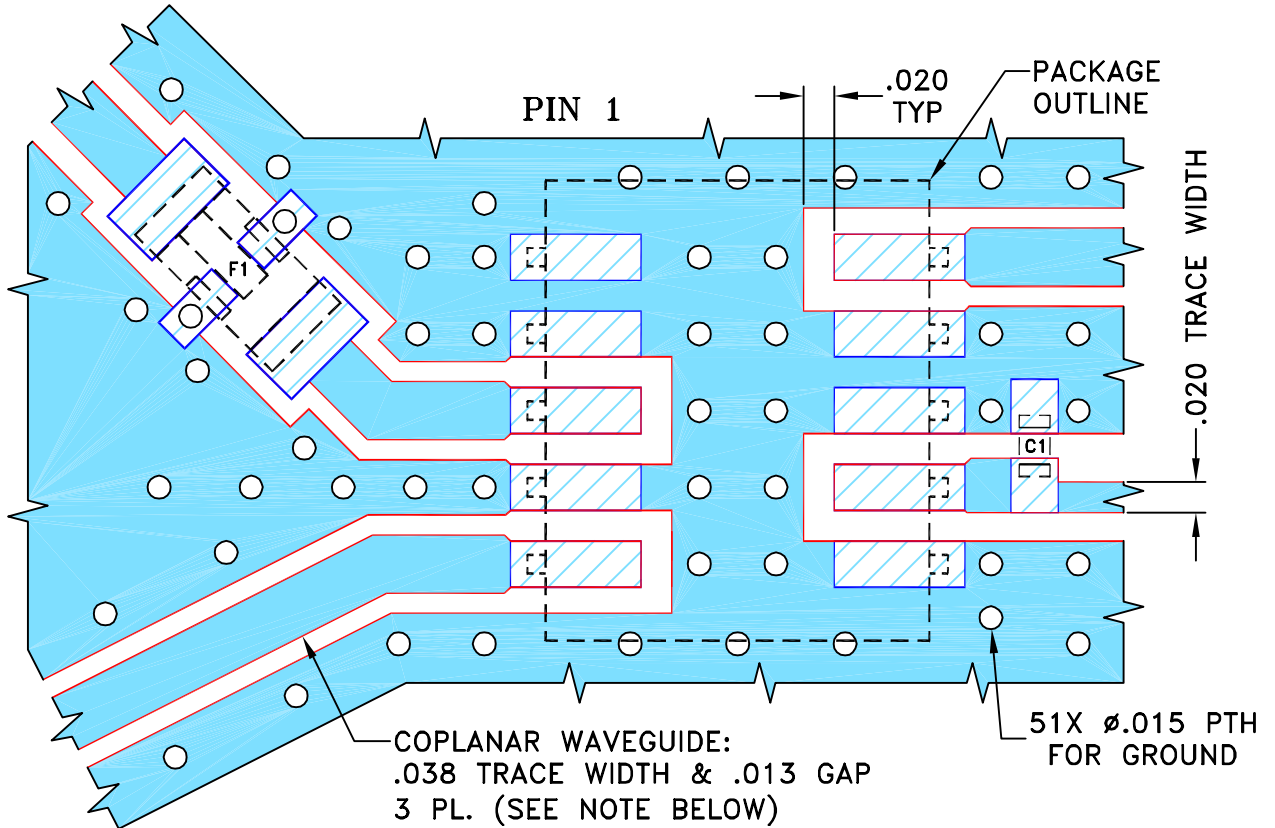

CAPACITOR C1: 1000 pF, 0402 SIZE
FILTER F1: LFCN-490+, FV1206 CASE STYLE

- NOTE: 1. COPLANAR WAVEGUIDE PARAMETERS ARE SHOWN FOR ROGERS RO4350B WITH DIELECTRIC THICKNESS 0.020" ± 0.0015".
COPPER: 1/2 OZ. EACH SIDE. FOR OTHER MATERIALS TRACE WIDTH MAY NEED TO BE MODIFIED.
2. BOTTOM SIDE OF THE PCB IS CONTINUOUS GROUND PLANE.



DENOTES PCB COPPER LAYOUT WITH SMOBC (SOLDER MASK OVER BARE COPPER)



DENOTES COPPER LAND PATTERN FREE OF SOLDER MASK

UNLESS OTHERWISE SPECIFIED	INITIALS	DATE
DIMENSIONS ARE IN INCHES TOLERANCES ON: 2 PL DECIMALS ± 3 PL DECIMALS ± .005 ANGLES ± FRACTIONS ±	DRAWN	AV 10/10/03
	CHECKED	IL 10/23/03
	APPROVED	DJ 10/23/03



Mini-Circuits® 13 Neptune Avenue
Brooklyn NY 11235

PL, 10MA01, DZ1034, MACA-242H+, TB-403

Mini-Circuits®
THIS DOCUMENT AND ITS CONTENTS ARE THE PROPERTY OF MINI-CIRCUITS. EXCEPT FOR USE EXPRESSLY GRANTED, IN WRITING, TO ITS VENDORS, VENDEE AND THE UNITED STATES GOVERNMENT, MINI-CIRCUITS RESERVES ALL PROPRIETARY DESIGN, USE, MANUFACTURING AND REPRODUCTION RIGHTS THERETO. THESE CONTENTS SHALL NOT BE USED, DUPLICATED OR DISCLOSED TO ANY OUTSIDE PARTY, IN WHOLE OR IN PART, WITHOUT WRITTEN PERMISSION OF MINI-CIRCUITS.

ASHEETA1.DWG REV:A DATE:01/12/95

SIZE	CODE IDENT	DRAWING NO:	REV:
A	15542	98-PL-145	C
FILE:	98PL145	SCALE:	8:1
		SHEET:	1 OF 1

Evaluation Board and Circuit

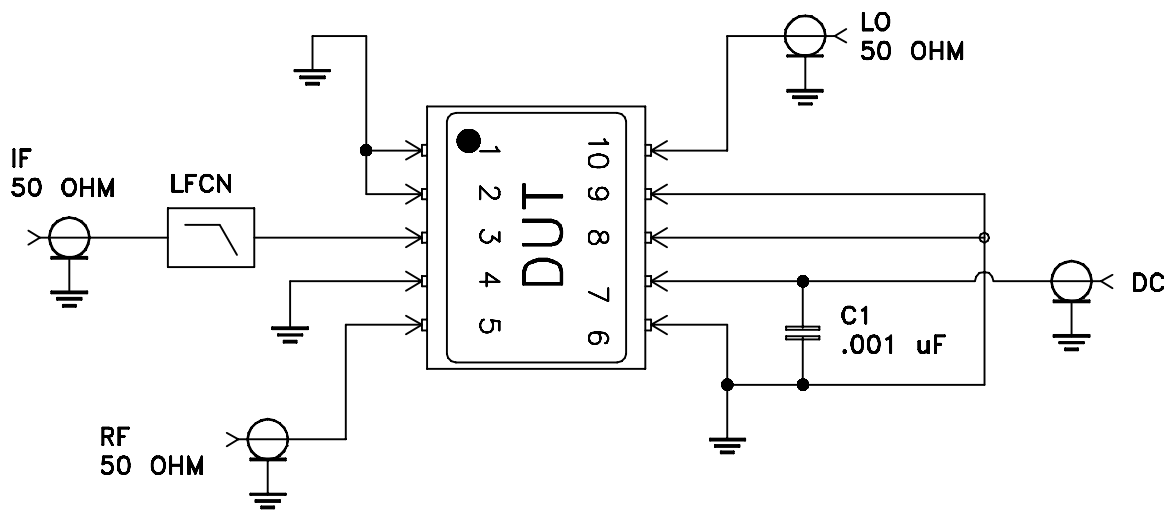
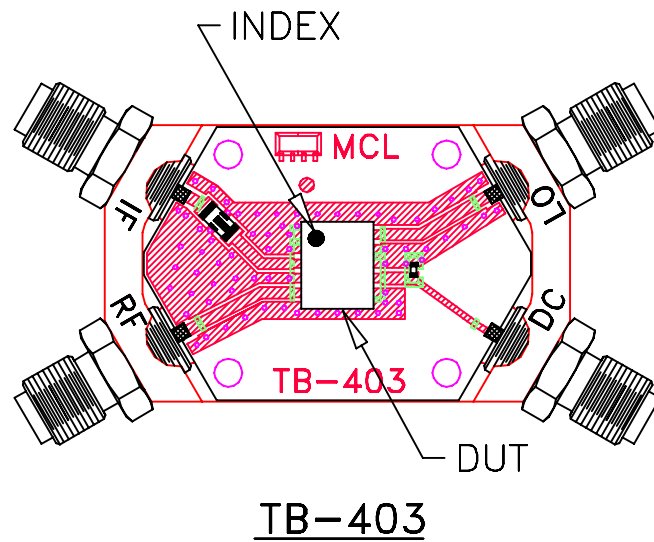

SCHEMATIC DIAGRAM

Notes:

1. SMA Female connectors.
2. PCB Material: Rogers R04350 or equivalent,
Dielectric Constant=3.5, Thickness=.020 inch.

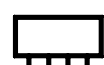
 **Mini-Circuits®**



All Mini-Circuits products are manufactured under exacting quality assurance and control standards, and are capable of meeting published specifications after being subjected to any or all of the following physical and environmental test.

Specification	Test/Inspection Condition	Reference/Spec
Operating Temperature	-55° to 100°C Ambient Environment	Individual Model Data Sheet
Storage Temperature	-55° to 100° C Ambient Environment	Individual Model Data Sheet
Autoclave	15 psig, 100% RH, 121°C, 96 hours	JESD22-A102-C, Condition C
Thermal Shock	-55° to 100°C, 100 cycles	MIL-STD-202, Method 107, Condition A-3, except +100°C
Solder Reflow Heat	Sn-Pb Eutectic Process: 225°C peak Pb-Free Process: 250°C peak	J-STD-020, Table 4-1, 4-2 and 5-2; Figure 5-1
Solderability	10X Magnification	J-STD-002, Para 4.2.5, Test S, 95% Coverage
Vibration (High Frequency)	20g peak, 10-2000 Hz, 12 times in each of three perpendicular directions (total 36)	MIL-STD-202, Method 204, Condition D
Mechanical Shock	50g, 11 ms, 1/2-sine, 18 shocks: 3 each direction, each of 3 axes	MIL-STD-202, Method 213, Condition A
Marking Resistance to Solvents	Isopropyl alcohol + mineral spirits at 25°C; terpene defluxer at 25°C; distilled water + proylene glycol monomethyl ether + monoethanolamine at 63°C to 70°C	MIL-STD-202, Method 215