

# Surface Mount Frequency Mixer

## MBA-15L+ MBA-15L

Level 4 (LO Power +4 dBm) 1200 to 2400 MHz



Generic photo used for illustration purposes only

CASE STYLE: SM2

**+RoHS Compliant**  
The +Suffix identifies RoHS Compliance. See our web site for RoHS Compliance methodologies and qualifications

### Maximum Ratings

Operating Temperature	-40°C to 85°C
Storage Temperature	-55°C to 100°C
RF Power	50mW
IF Current	40mA

Permanent damage may occur if any of these limits are exceeded.

### Pin Connections

LO	10
RF	5
IF	3
GROUND	1,2,4,6,7,8,9

### Outline Drawing

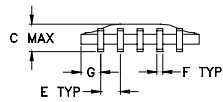
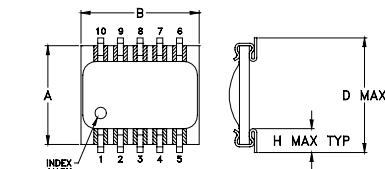

### PCB Land Pattern

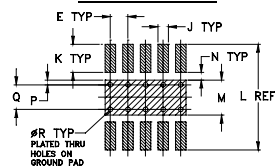

Suggested Layout,  
Tolerance to be within ±0.02  
ADJACENT GROUND PINS SHALL BE CONNECTED TO EACH OTHER AND TO GROUND PAD

### Outline Dimensions (inch/mm)

A	B	C	D	E	F	G	H	
.250	.300	.095	.290	.050	.015	.050	.060	
6.35	7.62	2.41	7.37	1.27	0.38	1.27	1.52	
J	K	L	M	N	P	Q	R	wt
.030	.080	.300	.100	.020	.015	.070	.014	grams
0.76	2.03	7.62	2.54	0.51	0.38	1.78	0.36	0.3

### Demo Board MCL P/N: TB-99 Suggested PCB Layout (PL-066)

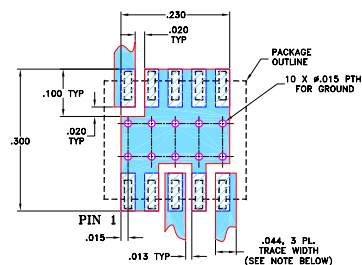

NOTES: 1. TRACE WIDTH IS SHOWN FOR ROGERS RO4350B WITH DIELECTRIC THICKNESS 0.020" ± 0.0015". COPPER: 1/2 OZ, EACH SIDE. FOR OTHER MATERIALS TRACE WIDTH MAY NEED TO BE MODIFIED.  
2. BOTTOM SIDE OF THE PCB IS CONTINUOUS GROUND PLANE.

- DENOTES PCB COPPER LAYOUT WITH SMOBC (SOLDER MASK OVER BARE COPPER)
- DENOTES COPPER LAND PATTERN FREE OF SOLDER MASK

### Notes

- Performance and quality attributes and conditions not expressly stated in this specification document are intended to be excluded and do not form a part of this specification document.
- Electrical specifications and performance data contained in this specification document are based on Mini-Circuit's applicable established test performance criteria and measurement instructions.
- The parts covered by this specification document are subject to Mini-Circuits standard limited warranty and terms and conditions (collectively, "Standard Terms"); Purchasers of this part are entitled to the rights and benefits contained therein. For a full statement of the Standard Terms and the exclusive rights and remedies thereunder, please visit Mini-Circuits' website at [www.minicircuits.com/MCLStore/terms.jsp](http://www.minicircuits.com/MCLStore/terms.jsp)

### Features

- excellent temperature stability
- excellent performance repeatability
- leads with strain relief
- very low cost
- ultra low height, 0.07"
- aqueous washable
- protected by US Patent 5,534,830

### Applications

- wireless local loop
- PCN/PCS/wideband CDMA
- WLAN
- satellite communication
- ISM band
- PCMCIA

### Electrical Specifications

FREQUENCY (MHz)		CONVERSION LOSS (dB)			LO-RF ISOLATION (dB)		LO-IF ISOLATION (dB)		IP3 at center band (dBm)
LO/RF	IF	$\bar{X}$	$\sigma$	Max.	Typ.	Min.	Typ.	Min.	Typ.
1200-2400	DC-600	6.5	0.1	8.5	27	15	20	10	10

1 dB COMP.: 0 dBm typ.

### Typical Performance Data

Frequency (MHz)		Conversion Loss (dB)	Isolation L-R (dB)	Isolation L-I (dB)	VSWR RF Port (:1)	VSWR LO Port (:1)
RF	LO	LO +4dBm	LO +4dBm	LO +4dBm	LO +4dBm	LO +4dBm
1200.00	1230.00	7.05	30.80	13.30	3.79	3.71
1250.00	1280.00	7.08	30.00	14.10	3.21	3.57
1300.00	1330.00	6.41	30.10	14.90	3.06	3.50
1350.00	1380.00	6.42	29.80	16.10	2.72	3.01
1400.00	1430.00	6.02	29.60	16.80	2.49	2.76
1450.00	1480.00	6.12	29.00	17.50	2.37	2.55
1500.00	1530.00	5.89	27.90	18.70	2.25	2.37
1600.00	1630.00	5.74	27.00	20.20	1.94	1.99
1700.00	1730.00	5.56	27.50	21.70	1.73	1.66
1800.00	1830.00	5.69	27.00	22.00	1.52	1.46
1900.00	1930.00	5.64	27.00	21.70	1.35	1.25
2000.00	2030.00	5.79	27.10	21.00	1.29	1.11
2100.00	2130.00	5.78	26.50	19.90	1.26	1.03
2150.00	2180.00	5.82	25.70	19.30	1.26	1.02
2200.00	2230.00	6.01	25.60	19.10	1.32	1.02
2250.00	2280.00	6.13	25.20	18.40	1.44	1.02
2300.00	2330.00	6.43	25.30	17.60	1.64	1.02
2350.00	2380.00	6.88	25.00	17.00	1.80	1.06
2400.00	2430.00	7.16	24.60	16.30	1.87	1.09
2500.00	2530.00	6.70	24.10	14.90	1.94	1.21

### Electrical Schematic

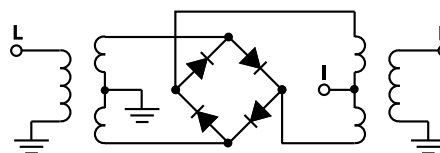

**Mini-Circuits**

[www.minicircuits.com](http://www.minicircuits.com) P.O. Box 350166, Brooklyn, NY 11235-0003 (718) 934-4500 sales@minicircuits.com

REV. F  
M151107  
MBA-15L  
EE-7756/2  
200815  
Page 1 of 2

## Performance Charts

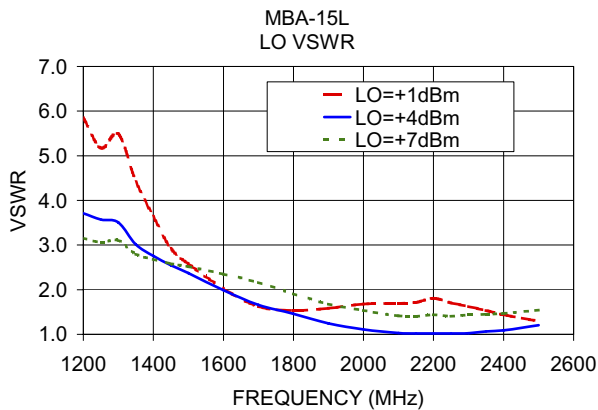
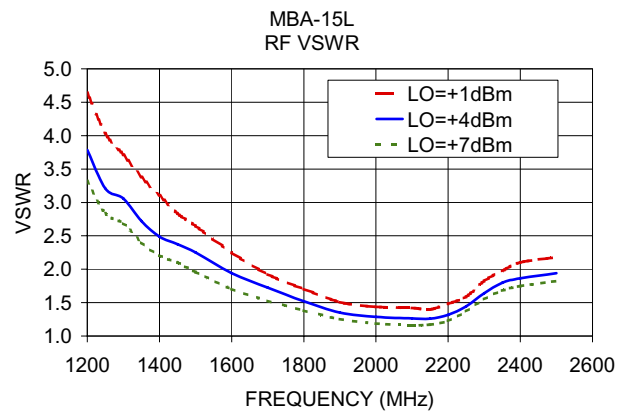
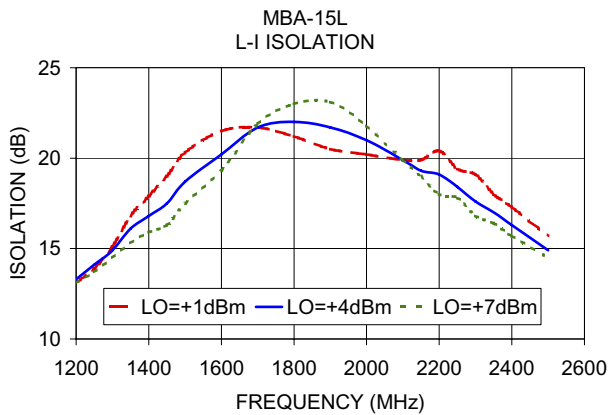
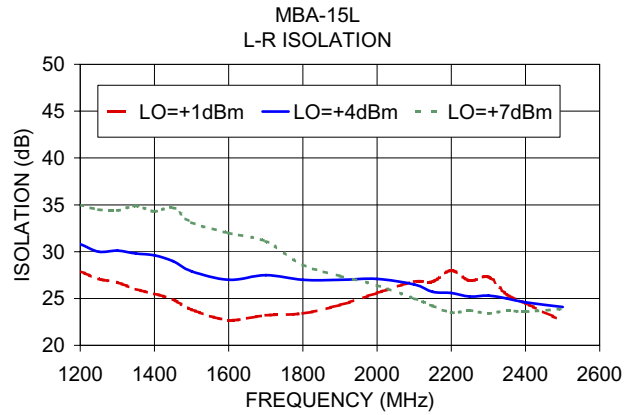
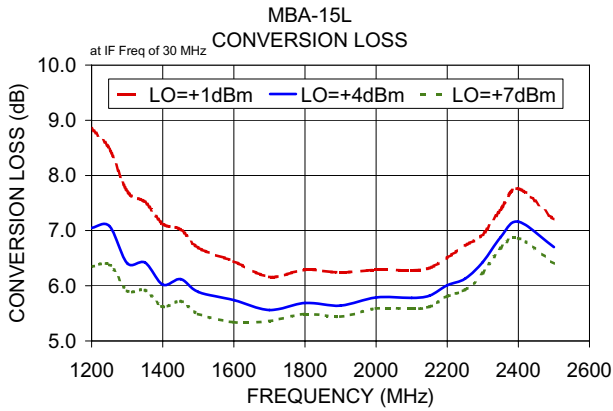

### Notes

- Performance and quality attributes and conditions not expressly stated in this specification document are intended to be excluded and do not form a part of this specification document.
- Electrical specifications and performance data contained in this specification document are based on Mini-Circuit's applicable established test performance criteria and measurement instructions.
- The parts covered by this specification document are subject to Mini-Circuits standard limited warranty and terms and conditions (collectively, "Standard Terms"); Purchasers of this part are entitled to the rights and benefits contained therein. For a full statement of the Standard Terms and the exclusive rights and remedies thereunder, please visit Mini-Circuits' website at [www.minicircuits.com/MCLStore/terms.jsp](http://www.minicircuits.com/MCLStore/terms.jsp)



# Frequency Mixer

# MBA-15L+

## Typical Performance Data

RF (IN) (MHz)	LO (MHz)	CONVERSION LOSS IF FIXED @IF(OUT)=30MHz (dB)			RF (IN) (MHz)	LO (MHz)	IP3 INPUT (dBm)			RF (IN) (MHz)	LO (MHz)	COMPRESSION @RF IN=0dBm (dB)		
		@LO (dBm)					@LO (dBm)					@LO (dBm)		
		+1	+4	+7			+1	+4	+7			+1	+4	+7
980.0	1010.0	18.27	12.20	9.75	980.0	1010.0	-1.20	7.04	8.55	980.0	1010.0	-3.90	-0.53	0.34
1060.0	1090.0	14.06	9.71	8.24	1060.0	1090.0	1.89	9.66	8.97	1060.0	1090.0	-1.81	0.41	0.65
1140.0	1170.0	11.07	8.20	7.31	1140.0	1170.0	6.00	8.55	8.83	1140.0	1170.0	-0.21	0.87	0.86
1220.0	1250.0	9.31	7.43	6.80	1220.0	1250.0	10.52	7.85	8.60	1220.0	1250.0	0.64	1.01	0.93
1300.0	1330.0	8.27	7.00	6.52	1300.0	1330.0	9.81	8.46	9.89	1300.0	1330.0	0.94	1.01	0.86
1380.0	1410.0	7.79	6.71	6.24	1380.0	1410.0	7.80	8.38	8.32	1380.0	1410.0	0.94	0.88	0.67
1460.0	1490.0	7.31	6.39	6.03	1460.0	1490.0	7.61	7.71	7.62	1460.0	1490.0	1.01	0.82	0.59
1540.0	1570.0	7.03	6.21	5.89	1540.0	1570.0	7.50	8.67	9.60	1540.0	1570.0	1.04	0.75	0.52
1620.0	1650.0	6.89	6.09	5.77	1620.0	1650.0	6.34	8.92	10.68	1620.0	1650.0	0.98	0.64	0.42
1700.0	1730.0	6.88	6.05	5.70	1700.0	1730.0	4.33	8.40	13.03	1700.0	1730.0	0.95	0.63	0.42
1780.0	1810.0	6.78	5.97	5.67	1780.0	1810.0	4.03	9.00	13.48	1780.0	1810.0	0.99	0.70	0.48
1860.0	1890.0	6.83	6.04	5.73	1860.0	1890.0	4.49	10.42	14.73	1860.0	1890.0	0.91	0.69	0.48
1940.0	1970.0	6.95	6.16	5.87	1940.0	1970.0	6.22	13.40	13.73	1940.0	1970.0	0.90	0.59	0.39
2020.0	2050.0	6.92	6.22	5.96	2020.0	2050.0	10.74	16.49	15.72	2020.0	2050.0	0.90	0.46	0.31
2100.0	2130.0	6.81	6.27	6.08	2100.0	2130.0	12.31	15.38	15.78	2100.0	2130.0	0.97	0.43	0.27
2200.0	2230.0	6.86	6.29	6.13	2200.0	2230.0	11.37	11.69	15.91	2200.0	2230.0	1.16	0.61	0.37
2280.0	2310.0	6.78	6.28	6.16	2280.0	2310.0	8.64	11.70	17.82	2280.0	2310.0	1.36	0.77	0.53
2380.0	2410.0	7.06	6.54	6.42	2380.0	2410.0	6.92	9.66	13.39	2380.0	2410.0	1.50	0.99	0.75
2460.0	2490.0	7.27	6.79	6.68	2460.0	2490.0	6.09	11.20	18.06	2460.0	2490.0	1.69	1.18	0.87
2560.0	2590.0	7.62	6.98	6.73	2560.0	2590.0	5.92	13.28	14.94	2560.0	2590.0	1.70	1.33	1.01
2640.0	2670.0	7.94	7.07	6.69	2640.0	2670.0	9.15	15.16	15.14	2640.0	2670.0	1.65	1.40	1.09
2740.0	2770.0	7.79	7.05	6.72	2740.0	2770.0	9.37	10.72	11.83	2740.0	2770.0	1.48	1.23	0.98
2820.0	2850.0	7.43	6.83	6.59	2820.0	2850.0	9.66	11.00	11.50	2820.0	2850.0	1.60	1.18	0.88
2920.0	2950.0	7.21	6.64	6.44	2920.0	2950.0	9.87	12.05	12.88	2920.0	2950.0	1.75	1.17	0.80
3000.0	3030.0	7.28	6.60	6.41	3000.0	3030.0	10.21	12.68	13.84	3000.0	3030.0	1.75	1.09	0.73
3100.0	3130.0	7.32	6.54	6.29	3100.0	3130.0	9.16	10.30	15.33	3100.0	3130.0	1.65	1.11	0.74
3180.0	3210.0	7.52	6.65	6.31	3180.0	3210.0	10.57	12.87	12.79	3180.0	3210.0	1.48	1.10	0.78
3280.0	3310.0	7.51	6.71	6.37	3280.0	3310.0	9.44	12.20	13.28	3280.0	3310.0	1.59	1.19	0.99
3360.0	3390.0	7.99	6.94	6.50	3360.0	3390.0	9.63	11.39	12.73	3360.0	3390.0	1.45	1.16	0.97
3460.0	3490.0	8.24	7.04	6.63	3460.0	3490.0	11.59	11.04	12.42	3460.0	3490.0	1.19	1.05	0.88
3540.0	3570.0	8.24	7.01	6.52	3540.0	3570.0	11.88	11.73	15.36	3540.0	3570.0	1.20	1.05	0.85
3640.0	3670.0	8.08	6.90	6.38	3640.0	3670.0	12.50	15.70	16.24	3640.0	3670.0	1.32	0.92	0.77
3720.0	3750.0	7.88	6.79	6.36	3720.0	3750.0	11.97	17.05	15.49	3720.0	3750.0	1.53	0.99	0.82
3820.0	3850.0	7.94	6.80	6.36	3820.0	3850.0	12.17	13.09	12.74	3820.0	3850.0	1.76	1.19	0.94
3900.0	3930.0	7.85	6.69	6.23	3900.0	3930.0	11.05	11.08	11.07	3900.0	3930.0	1.83	1.33	1.11
4000.0	4030.0	7.87	6.65	6.11	4000.0	4030.0	8.74	8.94	9.25	4000.0	4030.0	1.92	1.54	1.33
4080.0	4110.0	7.67	6.51	5.92	4080.0	4110.0	5.70	7.00	8.18	4080.0	4110.0	2.20	1.92	1.72
4180.0	4210.0	7.20	6.24	5.71	4180.0	4210.0	4.69	6.42	7.96	4180.0	4210.0	2.51	2.19	2.01
4260.0	4290.0	6.95	6.17	5.70	4260.0	4290.0	4.62	5.81	7.20	4260.0	4290.0	2.57	2.24	2.05
4360.0	4390.0	7.09	6.31	5.91	4360.0	4390.0	4.34	5.01	5.43	4360.0	4390.0	2.49	2.19	2.02

# Frequency Mixer

# MBA-15L+

## Typical Performance Data

IF (OUT) (MHz)	LO (MHz)	CONVERSION LOSS VS. IF FREQUENCY @RF(IN)=1800MHz (dB)	IF (OUT) (MHz)	LO (MHz)	CONVERSION LOSS VS. IF FREQUENCY @RF(IN)=1189.9MHz (dB)	IF (OUT) (MHz)	LO (MHz)	CONVERSION LOSS VS. IF FREQUENCY @RF(IN)=2410.1MHz (dB)
		@LO (dBm)			@LO (dBm)			@LO (dBm)
		+4			+4			+4
750.0	1050.0	10.52	10.1	1200.0	8.13	1110.1	1300.0	10.89
714.8	1085.2	9.49	30.1	1220.0	7.71	1090.1	1320.0	10.64
679.5	1120.5	8.80	50.1	1240.0	7.65	1070.1	1340.0	10.27
644.3	1155.7	8.11	70.1	1260.0	7.72	1050.1	1360.0	9.83
609.0	1191.0	7.54	90.1	1280.0	7.62	1030.1	1380.0	9.38
573.8	1226.2	7.15	110.1	1300.0	7.59	1010.1	1400.0	9.03
538.6	1261.4	6.90	130.1	1320.0	7.62	990.1	1420.0	8.71
503.3	1296.7	6.60	150.1	1340.0	7.65	970.1	1440.0	8.45
468.1	1331.9	6.58	190.1	1380.0	7.68	930.1	1480.0	7.67
432.9	1367.1	6.45	210.1	1400.0	7.70	910.1	1500.0	7.37
397.6	1402.4	6.35	250.1	1440.0	7.78	870.1	1540.0	6.98
362.4	1437.6	6.22	270.1	1460.0	7.78	850.1	1560.0	6.74
327.1	1472.9	5.99	310.1	1500.0	7.79	810.1	1600.0	6.58
291.9	1508.1	5.88	330.1	1520.0	7.90	790.1	1620.0	6.64
256.7	1543.3	5.77	370.1	1560.0	8.00	750.1	1660.0	6.74
221.4	1578.6	5.64	390.1	1580.0	8.04	730.1	1680.0	6.81
186.2	1613.8	5.61	430.1	1620.0	8.20	690.1	1720.0	6.98
151.0	1649.0	5.67	450.1	1640.0	8.28	670.1	1740.0	7.05
115.7	1684.3	5.69	490.1	1680.0	8.38	630.1	1780.0	7.00
80.5	1719.5	5.74	510.1	1700.0	8.43	610.1	1800.0	6.92
45.2	1754.8	5.78	550.1	1740.0	8.64	570.1	1840.0	6.86
10.0	1790.0	6.23	570.1	1760.0	8.64	550.1	1860.0	6.78
32.3	1832.3	5.96	610.1	1800.0	8.74	510.1	1900.0	6.72
77.0	1877.0	6.06	630.1	1820.0	8.96	490.1	1920.0	6.72
121.6	1921.6	6.19	670.1	1860.0	9.07	450.1	1960.0	6.71
188.6	1988.6	6.35	690.1	1880.0	9.10	430.1	1980.0	6.71
233.3	2033.3	6.43	730.1	1920.0	9.11	390.1	2020.0	6.60
300.2	2100.2	6.52	750.1	1940.0	9.00	370.1	2040.0	6.61
344.9	2144.9	6.56	790.1	1980.0	8.97	330.1	2080.0	6.54
411.9	2211.9	6.64	810.1	2000.0	8.90	310.1	2100.0	6.47
456.5	2256.5	6.64	850.1	2040.0	8.75	270.1	2140.0	6.47
523.5	2323.5	6.78	870.1	2060.0	8.90	250.1	2160.0	6.46
568.1	2368.1	6.96	910.1	2100.0	8.76	210.1	2200.0	6.49
635.1	2435.1	7.19	930.1	2120.0	8.82	190.1	2220.0	6.51
679.8	2479.8	7.42	970.1	2160.0	9.19	150.1	2260.0	6.60
746.7	2546.7	7.86	990.1	2180.0	9.23	130.1	2280.0	6.63
791.4	2591.4	8.23	1030.1	2220.0	9.57	90.1	2320.0	6.65
858.4	2658.4	8.89	1050.1	2240.0	10.06	70.1	2340.0	6.67
903.0	2703.0	9.53	1090.1	2280.0	10.88	30.1	2380.0	6.69
970.0	2770.0	10.53	1110.1	2300.0	11.33	10.1	2400.0	6.97

# Frequency Mixer

# MBA-15L+

## Typical Performance Data

LO (MHz)	LO-RF ISOLATION (dB)			LO-IF ISOLATION (dB)		
	@LO (dBm)			@LO (dBm)		
	+1	+4	+7	+1	+4	+7
1010.0	32.63	31.61	32.45	13.52	13.84	14.46
1090.0	30.54	30.39	32.65	13.58	13.89	14.52
1170.0	28.77	29.81	32.69	13.87	14.22	14.56
1250.0	27.95	29.84	33.18	14.59	14.92	14.94
1330.0	27.73	29.97	33.06	15.61	15.67	15.40
1410.0	27.64	29.83	32.84	17.09	16.82	16.26
1490.0	27.14	29.50	33.07	18.94	18.16	17.33
1570.0	26.92	29.69	33.82	21.21	19.73	18.66
1650.0	27.12	30.43	34.12	23.63	21.43	19.98
1730.0	28.67	32.09	33.39	26.31	23.49	21.82
1810.0	31.56	34.36	31.80	27.81	25.66	24.22
1890.0	35.58	33.45	28.81	26.56	27.17	26.52
1970.0	38.97	30.96	27.25	24.30	26.16	27.08
2050.0	38.92	29.79	26.27	22.18	23.92	25.18
2130.0	36.20	29.33	25.78	20.57	21.76	22.78
2230.0	32.02	27.35	24.40	19.57	20.29	20.81
2310.0	28.87	25.69	23.50	19.07	19.32	19.62
2410.0	26.18	24.85	23.26	18.17	18.23	18.32
2490.0	24.48	23.99	23.17	17.39	17.24	17.48
2590.0	23.22	24.16	24.15	16.28	16.04	16.35
2670.0	22.61	24.45	25.28	15.70	15.12	15.36
2770.0	21.93	23.00	23.85	14.91	14.29	14.54
2850.0	22.15	22.64	22.65	14.39	13.79	14.07
2950.0	22.70	22.70	22.01	13.60	13.11	13.46
3030.0	23.35	23.24	22.11	13.03	12.59	13.09
3130.0	24.09	24.81	23.51	12.52	12.16	12.67
3210.0	24.14	25.40	24.60	12.35	12.07	12.47
3310.0	23.55	24.40	24.12	12.19	12.06	12.41
3390.0	22.47	23.19	22.99	12.19	12.19	12.61
3490.0	21.80	21.98	21.72	12.15	12.08	12.75
3570.0	21.51	21.16	20.72	12.00	11.99	12.62
3670.0	21.04	19.90	19.45	12.05	11.71	12.33
3750.0	20.69	19.44	18.86	12.00	11.63	12.15
3850.0	20.63	19.17	18.49	12.16	11.65	12.10
3930.0	20.42	19.16	18.46	12.19	11.76	12.08
4030.0	19.83	18.95	18.46	12.30	12.00	12.26
4110.0	19.41	18.83	18.63	12.42	12.24	12.56
4210.0	19.09	19.04	19.25	12.54	12.56	13.11
4290.0	18.88	19.39	20.00	12.56	12.79	13.44
4390.0	19.07	19.98	21.06	12.80	13.03	13.66

RF (IN) (MHz)	LO (MHz)	RF-IF ISOLATION (dB)		
		@LO (dBm)		
		+1	+4	+7
980.0	1010.0	28.07	23.44	19.86
1060.0	1090.0	25.84	23.29	21.30
1140.0	1170.0	25.18	25.09	24.19
1220.0	1250.0	25.49	25.69	25.02
1300.0	1330.0	24.76	24.04	23.46
1380.0	1410.0	23.25	22.43	22.08
1460.0	1490.0	21.60	21.26	21.09
1540.0	1570.0	20.03	20.10	20.03
1620.0	1650.0	18.64	19.00	19.07
1700.0	1730.0	17.60	18.03	18.22
1780.0	1810.0	16.92	17.33	17.56
1860.0	1890.0	16.29	16.71	16.96
1940.0	1970.0	15.41	15.81	15.97
2020.0	2050.0	14.56	14.75	14.86
2100.0	2130.0	14.20	14.17	14.12
2200.0	2230.0	13.72	13.65	13.63
2280.0	2310.0	13.42	13.47	13.53
2380.0	2410.0	12.84	12.87	13.15
2460.0	2490.0	12.55	12.56	12.75
2560.0	2590.0	12.82	13.01	13.24
2640.0	2670.0	13.47	13.88	14.14
2740.0	2770.0	15.01	15.22	15.31
2820.0	2850.0	16.04	16.13	16.16
2920.0	2950.0	17.22	17.25	17.19
3000.0	3030.0	18.19	18.33	18.24
3100.0	3130.0	19.10	19.62	19.53
3180.0	3210.0	19.56	20.52	20.71
3280.0	3310.0	19.74	20.50	21.17
3360.0	3390.0	19.42	20.00	19.86
3460.0	3490.0	18.91	19.02	18.79
3540.0	3570.0	18.88	18.65	18.46
3640.0	3670.0	18.53	17.78	17.63
3720.0	3750.0	18.03	17.31	17.11
3820.0	3850.0	17.80	17.03	16.95
3900.0	3930.0	17.49	16.95	17.04
4000.0	4030.0	17.34	16.94	17.36
4080.0	4110.0	17.35	16.93	17.42
4180.0	4210.0	17.67	17.39	18.11
4260.0	4290.0	17.50	17.40	17.80
4360.0	4390.0	17.67	17.50	17.38

# Frequency Mixer

# MBA-15L+

## Typical Performance Data

RF (IN) (MHz)	LO (MHz)	RF VSWR (:1)			LO (MHz)	LO VSWR (:1)			IF (OUT) (MHz)	IF VSWR @LO=2400MHz (:1)		
		@LO (dBm)				@LO (dBm)				@LO (dBm)		
		+1	+4	+7		+1	+4	+7		+1	+4	+7
980.0	1010.0	11.61	7.90	6.26	1010.0	14.38	10.69	6.81	10.0	1.08	1.15	1.30
1060.0	1090.0	8.51	5.81	4.79	1090.0	11.85	7.44	4.93	30.0	1.10	1.14	1.30
1140.0	1170.0	6.39	4.55	3.82	1170.0	8.99	5.36	4.00	50.0	1.17	1.16	1.29
1220.0	1250.0	5.12	3.89	3.29	1250.0	6.56	4.09	3.38	70.0	1.20	1.19	1.31
1300.0	1330.0	4.17	3.29	2.80	1330.0	4.87	3.37	3.04	90.0	1.21	1.23	1.35
1380.0	1410.0	3.48	2.79	2.40	1410.0	3.81	2.87	2.71	110.0	1.26	1.25	1.35
1460.0	1490.0	2.95	2.42	2.14	1490.0	3.09	2.39	2.39	130.0	1.31	1.26	1.34
1540.0	1570.0	2.61	2.16	1.90	1570.0	2.60	2.06	2.14	150.0	1.37	1.31	1.37
1620.0	1650.0	2.37	1.95	1.70	1650.0	2.24	1.78	1.95	170.0	1.43	1.38	1.43
1700.0	1730.0	2.28	1.86	1.61	1730.0	1.99	1.58	1.82	190.0	1.48	1.41	1.46
1780.0	1810.0	2.09	1.70	1.50	1810.0	1.82	1.43	1.70	210.0	1.49	1.40	1.44
1860.0	1890.0	1.94	1.60	1.46	1890.0	1.74	1.35	1.63	230.0	1.55	1.44	1.45
1940.0	1970.0	1.76	1.47	1.41	1970.0	1.72	1.26	1.54	250.0	1.66	1.54	1.54
2020.0	2050.0	1.59	1.42	1.42	2050.0	1.73	1.17	1.44	270.0	1.71	1.58	1.57
2100.0	2130.0	1.53	1.41	1.45	2130.0	1.73	1.11	1.35	290.0	1.72	1.58	1.57
2200.0	2230.0	1.53	1.40	1.44	2230.0	1.83	1.17	1.27	310.0	1.78	1.62	1.59
2280.0	2310.0	1.52	1.39	1.43	2310.0	1.89	1.21	1.22	330.0	1.88	1.69	1.63
2380.0	2410.0	1.62	1.47	1.46	2410.0	1.96	1.27	1.20	350.0	1.94	1.74	1.67
2460.0	2490.0	1.86	1.70	1.66	2490.0	1.96	1.29	1.18	370.0	2.01	1.81	1.75
2560.0	2590.0	2.25	2.06	1.96	2590.0	1.94	1.29	1.18	390.0	2.04	1.83	1.75
2640.0	2670.0	2.76	2.48	2.27	2670.0	1.92	1.28	1.18	410.0	2.10	1.84	1.73
2740.0	2770.0	2.99	2.67	2.45	2770.0	1.88	1.28	1.22	430.0	2.20	1.92	1.81
2820.0	2850.0	2.95	2.60	2.38	2850.0	1.82	1.26	1.24	450.0	2.31	2.03	1.91
2920.0	2950.0	2.95	2.56	2.31	2950.0	1.80	1.30	1.28	470.0	2.36	2.07	1.93
3000.0	3030.0	3.04	2.57	2.28	3030.0	1.82	1.36	1.35	490.0	2.37	2.05	1.90
3100.0	3130.0	3.22	2.64	2.27	3130.0	1.87	1.46	1.44	510.0	2.48	2.14	1.98
3180.0	3210.0	3.34	2.77	2.32	3210.0	1.98	1.55	1.52	530.0	2.62	2.26	2.08
3280.0	3310.0	3.22	2.75	2.38	3310.0	2.16	1.69	1.59	550.0	2.67	2.29	2.11
3360.0	3390.0	3.20	2.66	2.29	3390.0	2.40	1.80	1.60	590.0	2.79	2.39	2.18
3460.0	3490.0	3.15	2.51	2.14	3490.0	2.68	1.96	1.62	610.0	2.89	2.46	2.23
3540.0	3570.0	3.10	2.41	2.00	3570.0	2.89	2.12	1.66	650.0	3.12	2.67	2.42
3640.0	3670.0	2.84	2.21	1.84	3670.0	3.09	2.19	1.68	670.0	3.12	2.65	2.40
3720.0	3750.0	2.66	2.13	1.81	3750.0	3.18	2.22	1.66	710.0	3.33	2.83	2.57
3820.0	3850.0	2.46	2.01	1.73	3850.0	3.14	2.13	1.56	730.0	3.53	3.00	2.72
3900.0	3930.0	2.36	1.94	1.67	3930.0	2.92	1.97	1.41	770.0	3.59	3.02	2.73
4000.0	4030.0	2.20	1.80	1.56	4030.0	2.69	1.77	1.24	790.0	3.74	3.17	2.87
4080.0	4110.0	2.09	1.72	1.46	4110.0	2.43	1.65	1.19	830.0	4.01	3.39	3.08
4180.0	4210.0	1.82	1.52	1.31	4210.0	2.13	1.48	1.23	850.0	4.09	3.46	3.14
4260.0	4290.0	1.75	1.50	1.35	4290.0	1.82	1.37	1.35	890.0	4.29	3.65	3.34
4360.0	4390.0	1.82	1.58	1.45	4390.0	1.51	1.34	1.56	910.0	4.50	3.84	3.53

## Harmonics Tables

RF HARMONICS ORDER

	(-dBm)	(-dBc)										
0	-	-	1	14	+1	15	18	34	54	37	51	58
1	-	11	+0	22	19	22	28	41	52	47	45	54
2	90	46	53	42	46	65	38	42	46	52	63	53
3	>90	59	57	59	60	54	58	51	63	62	64	>69
4	>90	>69	>69	>69	>69	61	>69	>69	67	>69	>69	>69
5	>90	>69	>69	>69	>69	>69	>69	>69	>69	>69	>69	>69
6	>90	>69	>69	>69	>69	>69	>69	>69	>69	>69	>69	>69
7	>90	>69	>69	>69	>69	>69	>69	>69	>69	>69	>69	>69
8	>90	>69	>69	>69	>69	>69	>69	>69	>69	>69	>69	>69
9	>90	>69	>69	>69	>69	>69	>69	>69	>69	>69	>69	>69
10	>90	>69	>69	>69	>69	>69	>69	>69	>69	>69	>69	>69
	RF CAL	0	1	2	3	4	5	6	7	8	9	10

### LO HARMONICS ORDER

Test conditions: RF IN: 1800 MHz; -15.00 dBm.  
 LO IN: 1830 MHz; +4.00 dBm  
 IF OUT: 30 MHz; -21.19 dBm

RF HARMONICS ORDER

	(-dBm)	(-dBc)										
0	-	-	11	27	11	32	33	45	55	46	59	62
1	-	11	+0	25	19	28	30	44	67	60	59	65
2	69	36	46	41	43	46	34	39	48	53	68	64
3	>90	43	37	43	40	39	41	40	47	53	57	63
4	>90	57	54	51	59	47	57	62	51	53	59	63
5	>90	>79	58	64	71	59	52	53	54	51	62	63
6	>90	72	71	>79	62	61	68	55	66	67	64	>79
7	>90	78	>79	>79	69	>79	75	79	59	68	63	61
8	>90	77	>79	>79	>79	>79	70	72	78	66	76	75
9	>90	>79	>79	>79	>79	>79	>79	>79	>79	>79	70	>79
10	>90	>79	>79	>79	>79	>79	>79	>79	>79	>79	>79	79
	RF CAL	0	1	2	3	4	5	6	7	8	9	10

### LO HARMONICS ORDER

Test conditions: RF IN: 1800 MHz; -5.00 dBm.  
 LO IN: 1830 MHz; +4.00 dBm  
 IF OUT: 30 MHz; -11.25 dBm

- Notes: 1. All Harmonics are in (dBc) relative to IF OUTPUT.  
 2. + entry denotes harmonics are in (dBc) above IF OUTPUT.  
 3. RF Cal represent the Harmonics level of the RF input signal to the mixer.

## Typical Performance Curves

Conversion Loss @ IF=30MHz

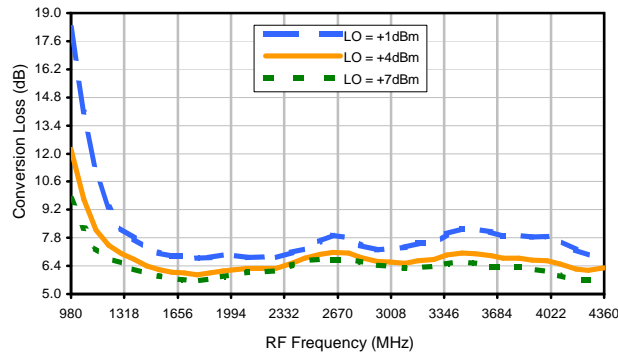

Conversion Loss vs. LO @ RF=1800MHz

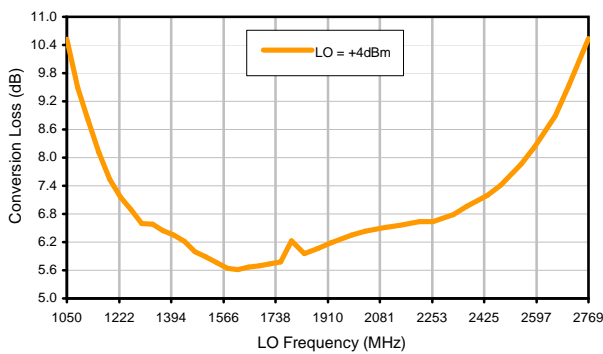

Conversion Loss vs. IF @ RF=1800MHz

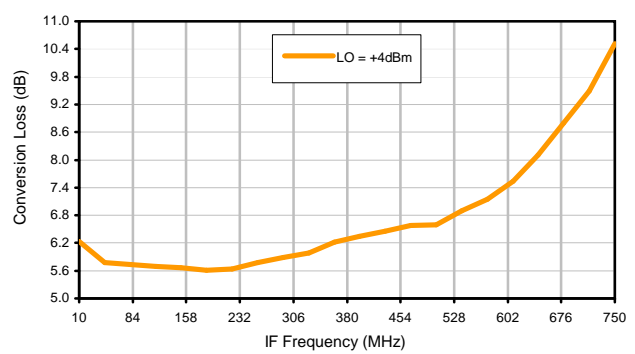

Conversion Loss vs. IF @ RF=1189.9MHz

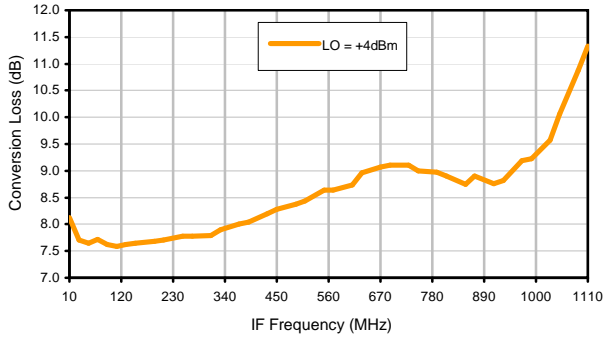

Conversion Loss vs. IF @ RF=2410.1MHz

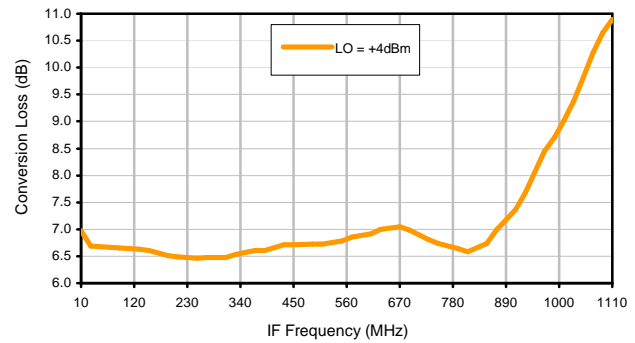

IP3 Input

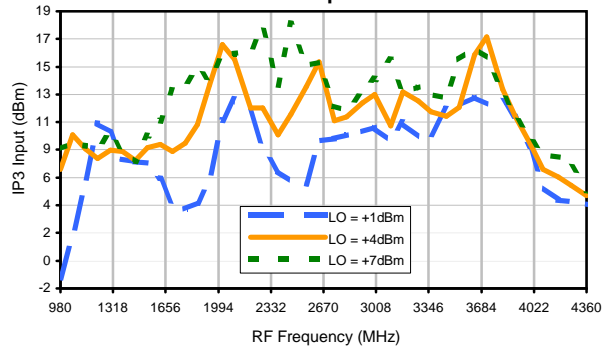

Compression @ RF IN=0dBm

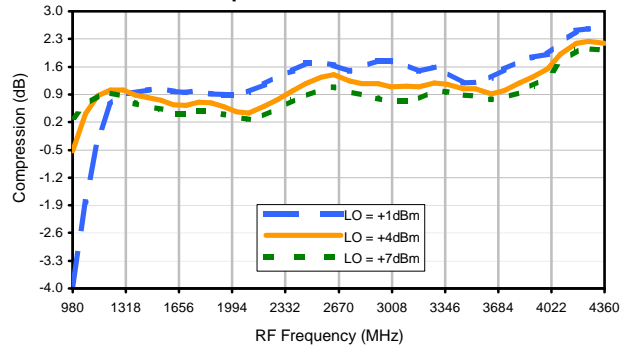

## Typical Performance Curves

LO-RF Isolation

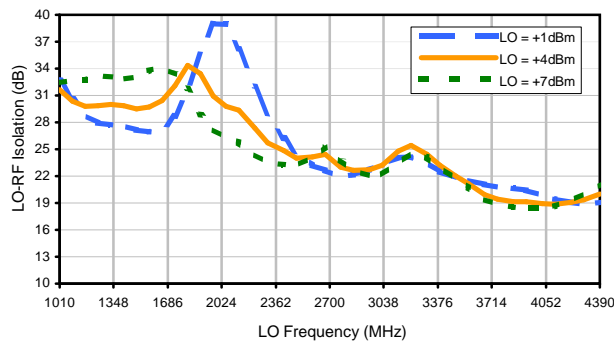

LO-IF Isolation

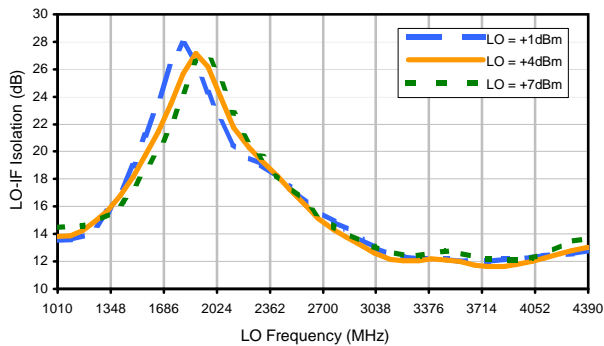

RF-IF Isolation

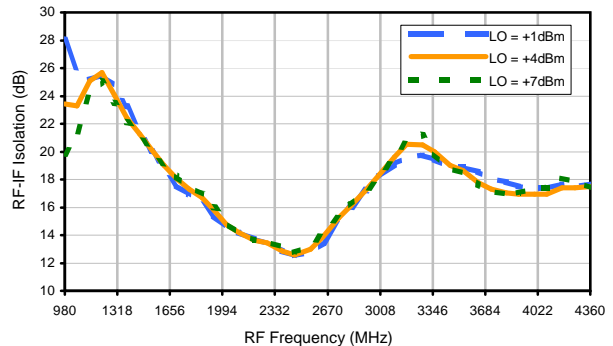

RF VSWR

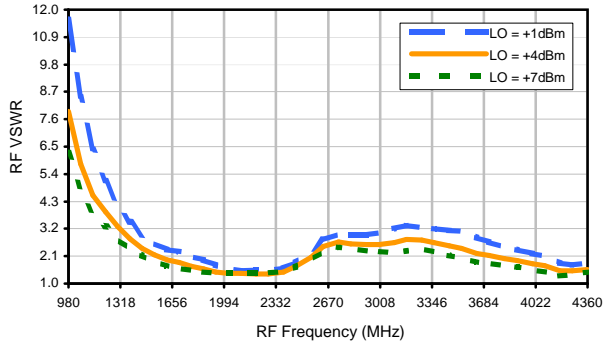

LO VSWR

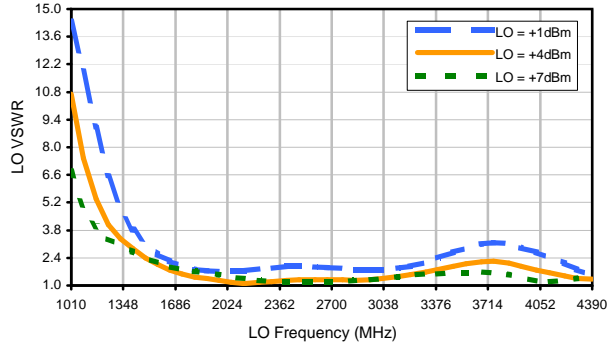

IF VSWR

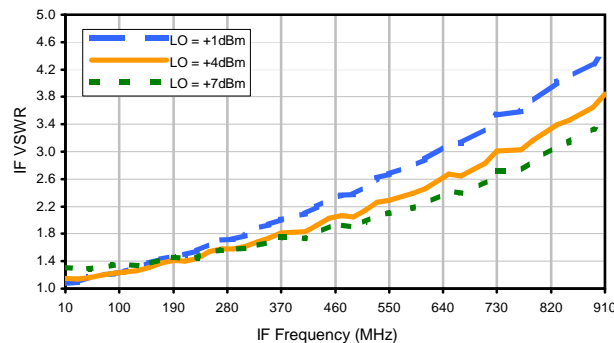

## Harmonics Tables

RF HARMONICS ORDER

	(-dBm)	(-dBc)										
0	-	-	1	14	+1	15	18	34	54	37	51	58
1	-	11	+0	22	19	22	28	41	52	47	45	54
2	90	46	53	42	46	65	38	42	46	52	63	53
3	>90	59	57	59	60	54	58	51	63	62	64	>69
4	>90	>69	>69	>69	>69	61	>69	>69	67	>69	>69	>69
5	>90	>69	>69	>69	>69	>69	>69	>69	>69	>69	>69	>69
6	>90	>69	>69	>69	>69	>69	>69	>69	>69	>69	>69	>69
7	>90	>69	>69	>69	>69	>69	>69	>69	>69	>69	>69	>69
8	>90	>69	>69	>69	>69	>69	>69	>69	>69	>69	>69	>69
9	>90	>69	>69	>69	>69	>69	>69	>69	>69	>69	>69	>69
10	>90	>69	>69	>69	>69	>69	>69	>69	>69	>69	>69	>69
	RF CAL	0	1	2	3	4	5	6	7	8	9	10

### LO HARMONICS ORDER

Test conditions: RF IN: 1800 MHz; -15.00 dBm.  
 LO IN: 1830 MHz; +4.00 dBm  
 IF OUT: 30 MHz; -21.19 dBm

RF HARMONICS ORDER

	(-dBm)	(-dBc)										
0	-	-	11	27	11	32	33	45	55	46	59	62
1	-	11	+0	25	19	28	30	44	67	60	59	65
2	69	36	46	41	43	46	34	39	48	53	68	64
3	>90	43	37	43	40	39	41	40	47	53	57	63
4	>90	57	54	51	59	47	57	62	51	53	59	63
5	>90	>79	58	64	71	59	52	53	54	51	62	63
6	>90	72	71	>79	62	61	68	55	66	67	64	>79
7	>90	78	>79	>79	69	>79	75	79	59	68	63	61
8	>90	77	>79	>79	>79	>79	70	72	78	66	76	75
9	>90	>79	>79	>79	>79	>79	>79	>79	>79	>79	70	>79
10	>90	>79	>79	>79	>79	>79	>79	>79	>79	>79	>79	79
	RF CAL	0	1	2	3	4	5	6	7	8	9	10

### LO HARMONICS ORDER

Test conditions: RF IN: 1800 MHz; -5.00 dBm.  
 LO IN: 1830 MHz; +4.00 dBm  
 IF OUT: 30 MHz; -11.25 dBm

- Notes: 1. All Harmonics are in (dBc) relative to IF OUTPUT.  
 2. + entry denotes harmonics are in (dBc) above IF OUTPUT.  
 3. RF Cal represent the Harmonics level of the RF input signal to the mixer.

# Case Style

# SM2

SM2

## Outline Dimensions

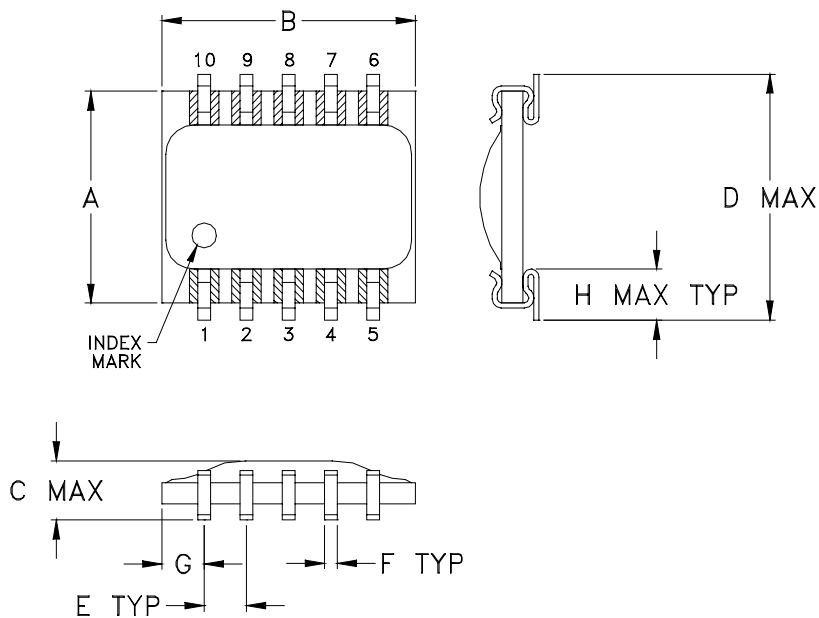

## PCB Land Pattern

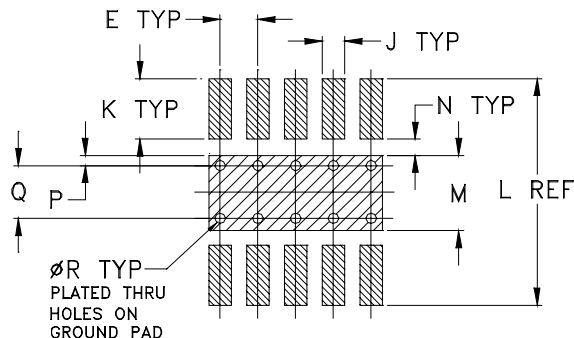

Suggested Layout,  
Tolerance to be within  $\pm .002$

ADJACENT GROUND PINS SHALL BE CONNECTED  
TO EACH OTHER AND TO GROUND PAD

CASE #	A	B	C	D	E	F	G	H	J	K	L	M	N	P
SM2	.250 (6.35)	.300 (7.62)	.095 (2.41)	.290 (7.37)	.050 (1.27)	.015 (0.38)	.050 (1.27)	.060 (1.52)	.030 (0.76)	.080 (2.03)	.300 (7.62)	.100 (2.54)	.020 (0.51)	.015 (0.38)

CASE #	Q	R	WT. GRAM
SM2	.070 (1.78)	.014 (0.36)	.3

Dimensions are in inches (mm). Tolerances:  $\pm .005$

### Notes:

1. Case material: Plastic encapsulation on Ceramic base.
2. Termination finish:  
For RoHS Case Styles: Tin plate over Nickel plate.  
For RoHS-5 Case Styles: Tin-Lead plate.



INTERNET <http://www.minicircuits.com>

P.O. Box 350166, Brooklyn, New York 11235-0003 (718) 934-4500 Fax (718) 332-4661

Distribution Centers NORTH AMERICA 800-654-7949 • 417-335-5935 • Fax 417-335-5945 • EUROPE 44-1252-832600 • Fax 44-1252-837010

Mini-Circuits ISO 9001 & ISO 14001 Certified

# Tape & Reel Packaging TR-F34



Tape Width, mm	Device Cavity Pitch, mm	Reel Size, inches	Devices per Reel see note	
16	12	7	Small quantity standard (see note)	20
				50
				100
				200
		13	Standard	500
				1000

Note: Availability of small reel quantity varies by model.  
Refer to pricing and availability on individual model dashboard.

Mini-Circuits carrier tape materials provide protection from ESD (Electro-Static Discharge) during handling and transportation. Tapes are static dissipative and comply with industry standards EIA-481/EIA-541.

Go to: [www.minicircuits.com/pages/pdfs/tape.pdf](http://www.minicircuits.com/pages/pdfs/tape.pdf)



INTERNET <http://www.minicircuits.com>

P.O. Box 350166, Brooklyn, New York 11235-0003 (718) 934-4500 Fax (718) 332-4661

Distribution Centers NORTH AMERICA 800-654-7949 • 417-335-5935 • Fax 417-335-5945 • EUROPE 44-1252-832600 • Fax 44-1252-837010

Mini-Circuits ISO 9001 & ISO 14001 Certified

THIRD ANGLE PROJECTION

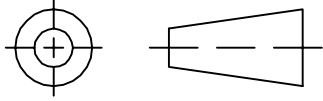

REVISIONS

REV	ECN No.	DESCRIPTION	DATE	DR	AUTH
OR	M82272	NEW RELEASE	08/02/02	GF	DJ
A	M102713	UPDATED NOTES, ADDED "...WITH SMOBC"	01/16/06	GT	IL

SUGGESTED MOUNTING CONFIGURATION FOR SM2 CASE STYLE, "Id" PIN CONNECTION

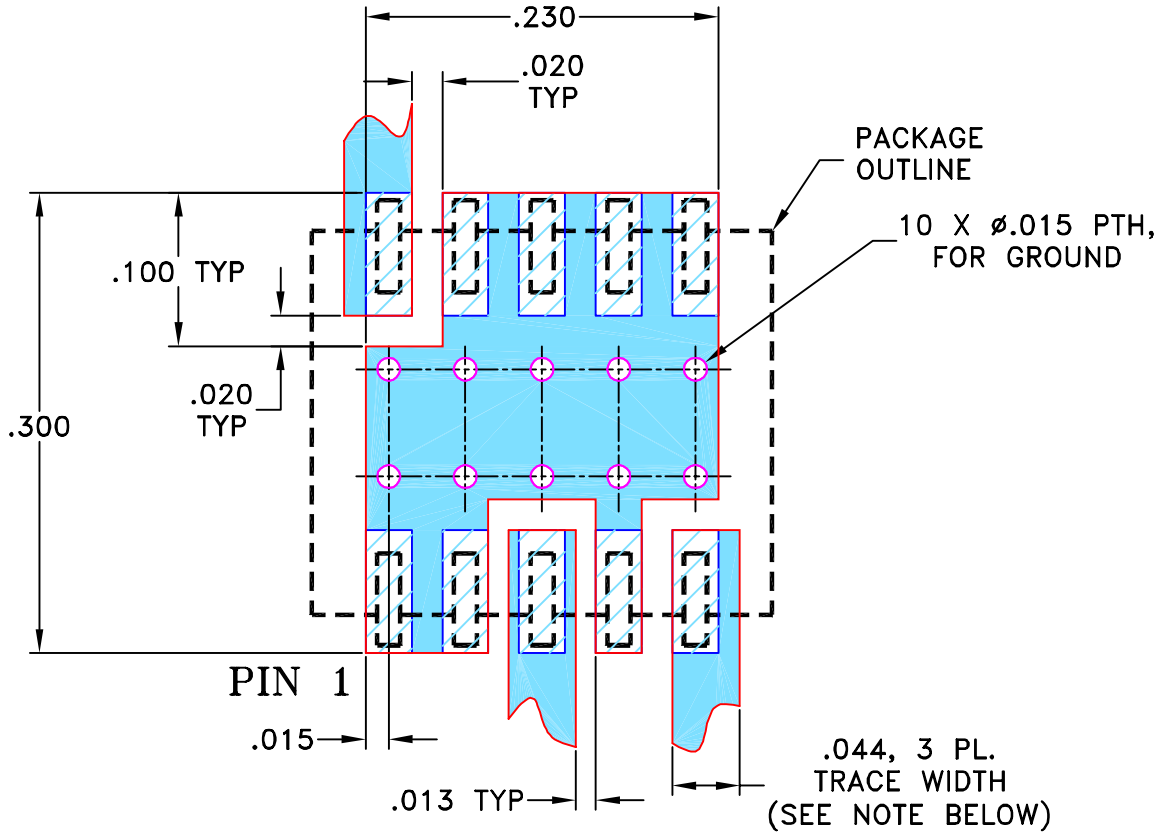

- NOTES: 1. TRACE WIDTH IS SHOWN FOR ROGERS R04350B WITH DIELECTRIC THICKNESS 0.020" ± 0.0015". COPPER: 1/2 OZ. EACH SIDE. FOR OTHER MATERIALS TRACE WIDTH MAY NEED TO BE MODIFIED.

2. BOTTOM SIDE OF THE PCB IS CONTINUOUS GROUND PLANE.

 DENOTES PCB COPPER LAYOUT WITH SMOBC (SOLDER MASK OVER BARE COPPER)

 DENOTES COPPER LAND PATTERN FREE OF SOLDER MASK

UNLESS OTHERWISE SPECIFIED	INITIALS	DATE
DIMENSIONS ARE IN INCHES	DRAWN GF	07/18/02
TOLERANCES ON:	CHECKED WL	08/02/02
2 PL DECIMALS ±	APPROVED DJ	08/02/02
3 PL DECIMALS ± .005		
ANGLES ±		
FRACTIONS ±		

 **Mini-Circuits**<sup>®</sup> 13 Neptune Avenue  
Brooklyn NY 11235

PL, Id, SM2, MBA, TB-99

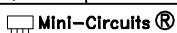
 Mini-Circuits<sup>®</sup>  
THIS DOCUMENT AND ITS CONTENTS ARE THE PROPERTY OF MINI-CIRCUITS. EXCEPT FOR USE EXPRESSLY GRANTED, IN WRITING, TO ITS VENDORS, VENDEE AND THE UNITED STATES GOVERNMENT, MINI-CIRCUITS RESERVES ALL PROPRIETARY DESIGN, USE, MANUFACTURING AND REPRODUCTION RIGHTS THERETO. THESE CONTENTS SHALL NOT BE USED, DUPLICATED OR DISCLOSED TO ANY OUTSIDE PARTY, IN WHOLE OR IN PART, WITHOUT WRITTEN PERMISSION OF MINI-CIRCUITS.

SIZE A	CODE IDENT 15542	DRAWING NO: 98-PL-066	REV: A
FILE: 98PL066	SCALE: 8:1	SHEET: 1 OF 1	

# Evaluation Board and Circuit

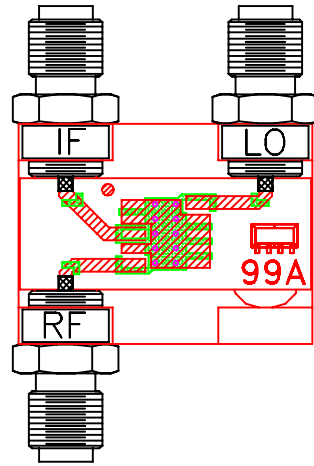

TB-99

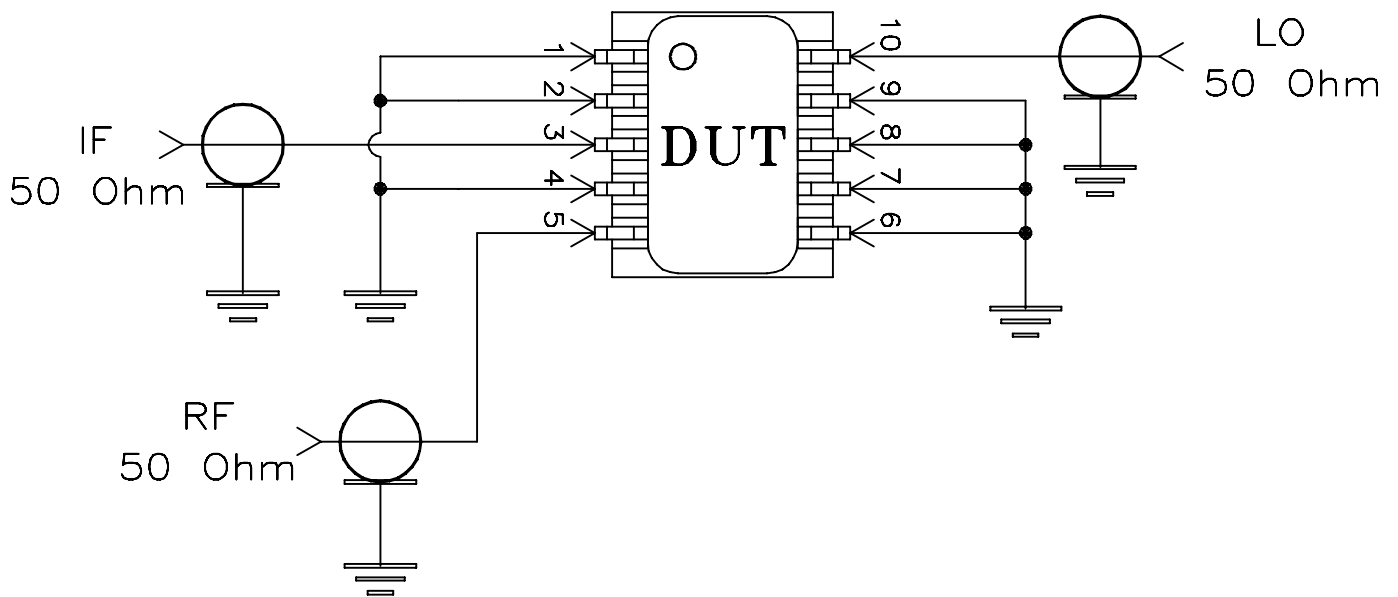

Schematic Diagram

## Notes:

1. SMA Female connectors.
2. PCB Material: Rogers R04350 or equivalent,  
Dielectric Constant=3.5, Thickness=.020 inch.

 Mini-Circuits®

All Mini-Circuits products are manufactured under exacting quality assurance and control standards, and are capable of meeting published specifications after being subjected to any or all of the following physical and environmental test.

Specification	Test/Inspection Condition	Reference/Spec
Operating Temperature	-40° to 85°C Ambient Environment	Individual Model Data Sheet
Storage Temperature	-55° to 100° C Ambient Environment	Individual Model Data Sheet
Humidity	90 to 95% RH, 240 hours, 50°C	MIL-STD-202, Method 103, Condition A, Except 50°C and end-point electrical test done within 12 hours
Thermal Shock	-55° to 100°C, 100 cycles	MIL-STD-202, Method 107, Condition A-3, except +100°C
Solder Reflow Heat	Sn-Pb Eutetic Process: 225°C peak Pb-Free Process 245° - 250°C peak	J-STD-020, Table 4-1, 4-2 and 5-2, Figure 5-1
Solderability	10X Magnification	J-STD-002, 95% Coverage
Vibration (High Frequency)	20g peak, 10-2000 Hz, 12 times in each of three perpendicular directions (total 36)	MIL-STD-202, Method 204, Condition D
Mechanical Shock	50g, 11 ms, 1/2-sine, 18 shocks: 3 each direction, each of 3 axes	MIL-STD-202, Method 213, Condition A
Marking Resistance to Solvents	Isopropyl alcohol + mineral spirits at 25°C; terpene defluxer at 25°C; distilled water + proylene glycol monomethyl ether + monoethanolamine at 63°C to 70°C	MIL-STD-202, Method 215