

## Non-Catalog Model

# Frequency Mixer

# MBA-35MH

Level 13 (LO Power +13 dBm)

### Important Note

This is a non-catalog model and can be manufactured on specific request. Pricing and delivery information can be supplied upon request.



Please click "Back", and then click "Contact Us" for Applications support.

**CASE STYLE : SM2**

ELECTRICAL SPECIFICATIONS 50Ω @ +25°C					
Parameter		Min.	Typ.	Max.	Units
Frequency	LO (fL to fU)	3000		4000	MHz
	RF (fL to fU)	3000		4000	MHz
	IF	0		700	MHz
Conversion Loss			5.1	8.7	dB
LO-RF Isolation		15	22		dB
LO-IF Isolation		8	14		dB
IP3 Input			+15		dBm
1 dB Comp. Input Power			+9		dBm

**Note:** units are non-hermetic.

MAXIMUM RATINGS	
Operating Temperature	-40°C to 85°C
Storage Temperature	-55°C to 100°C
RF Power	200mW
IF Current	40mA

### Electrical Schematics

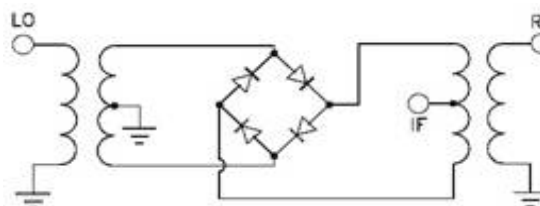

PIN CONNECTIONS	
LO	10
RF	5
IF	3
GROUND	1, 2, 4, 6, 7, 8, 9

# Frequency Mixer

# MBA-35MH

## Typical Performance Data

RF (MHz)	LO (MHz)	CONVERSION LOSS (dB)			LO (MHz)	LO-RF ISOLATION (dB)			LO-IF ISOLATION (dB)		
		@LO (dBm)				@LO (dBm)			@LO (dBm)		
		+10	+13	+16		+10	+13	+16	+10	+13	+16
3000.0	3030.0	5.36	5.20	5.03	3030.0	27.8	25.8	24.2	13.8	11.9	10.7
3050.0	3080.0	5.36	5.21	4.86	3080.0	27.3	25.4	23.6	13.9	11.9	10.6
3100.0	3130.0	5.20	5.18	4.87	3130.0	26.7	25.4	24.0	14.7	12.4	11.1
3150.0	3180.0	5.19	5.00	4.86	3180.0	26.0	24.8	23.3	15.0	12.6	11.2
3200.0	3230.0	5.17	4.98	4.84	3230.0	25.7	24.7	23.5	15.5	13.0	11.5
3250.0	3280.0	5.16	4.97	4.83	3280.0	25.2	24.4	23.0	15.9	13.1	11.7
3300.0	3330.0	5.15	4.96	4.82	3330.0	25.0	24.0	22.6	16.5	13.3	11.6
3350.0	3380.0	5.15	4.96	4.82	3380.0	24.7	23.7	22.3	16.9	13.6	11.9
3400.0	3430.0	5.27	5.09	4.77	3430.0	24.3	23.2	22.0	17.0	13.8	11.9
3450.0	3480.0	5.27	5.09	4.77	3480.0	23.8	23.0	21.8	17.1	14.1	12.2
3500.0	3530.0	5.22	5.05	4.88	3530.0	23.4	22.7	21.4	17.2	14.3	12.4
3550.0	3580.0	5.25	5.08	4.91	3580.0	23.1	22.5	21.3	17.7	14.8	12.7
3600.0	3630.0	5.38	5.05	4.88	3630.0	22.8	22.3	21.2	18.0	14.9	13.0
3650.0	3680.0	5.36	5.20	4.86	3680.0	22.5	22.1	21.1	19.0	15.4	13.4
3700.0	3730.0	5.52	5.20	5.02	3730.0	22.3	21.8	20.8	19.6	15.9	13.6
3750.0	3780.0	5.37	5.22	5.04	3780.0	22.0	21.5	20.6	20.3	16.2	13.9
3800.0	3830.0	5.55	5.39	5.05	3830.0	21.7	21.2	20.2	21.2	16.7	14.4
3950.0	3980.0	5.69	5.54	5.35	3980.0	20.5	20.2	19.7	23.8	19.7	16.7
3970.0	4000.0	5.86	5.72	5.36	4000.0	20.4	19.9	19.4	23.8	19.8	16.9
4000.0	4030.0	5.86	5.87	5.53	4030.0	20.2	19.7	19.1	23.8	20.2	17.4

REV. X1  
MBA-35MH  
060613  
Page 1 of 2



IF/RF MICROWAVE COMPONENTS • ISO 9001 ISO 14001 AS 9100 CERTIFIED RoHS compliant  
P.O. Box 350166, Brooklyn, New York 11235-0003 (718) 934-4500 Fax (718) 332-4661



The Design Engineers Search Engine finds the model you need, Instantly • For detailed performance specs & shopping online see



# Frequency Mixer

# MBA-35MH

## Typical Performance Data

RF/LO (MHz)	RF VSWR (:1)			LO VSWR (:1)			IF (MHz)	IF VSWR (:1)		
	@LO (dBm)			@LO (dBm)				@LO (dBm)		
	+10	+13	+16	+10	+13	+16		+10	+13	+16
3030.0	1.39	1.39	1.42	1.51	1.54	1.81	0.1	1.66	1.31	1.11
3080.0	1.33	1.33	1.36	1.54	1.60	1.89	0.5	1.62	1.28	1.08
3130.0	1.28	1.26	1.29	1.59	1.59	1.88	1.0	1.64	1.30	1.09
3180.0	1.22	1.20	1.23	1.65	1.65	1.97	2.0	1.63	1.29	1.08
3230.0	1.18	1.13	1.17	1.67	1.65	1.92	10.0	1.59	1.27	1.07
3280.0	1.15	1.07	1.11	1.71	1.69	1.96	20.0	1.58	1.26	1.07
3330.0	1.18	1.02	1.08	1.80	1.77	2.04	30.0	1.58	1.26	1.08
3380.0	1.22	1.11	1.15	1.88	1.81	2.08	50.0	1.57	1.27	1.11
3430.0	1.26	1.17	1.21	1.99	1.94	2.25	70.0	1.61	1.30	1.15
3480.0	1.31	1.23	1.25	2.01	1.97	2.35	100.0	1.65	1.35	1.21
3530.0	1.38	1.29	1.29	2.16	2.06	2.37	111.9	1.70	1.39	1.25
3580.0	1.44	1.35	1.34	2.16	2.03	2.35	223.6	1.87	1.59	1.48
3630.0	1.49	1.40	1.39	2.25	2.04	2.30	300.0	2.06	1.80	1.67
3680.0	1.55	1.46	1.44	2.32	2.04	2.25	335.4	2.18	1.89	1.76
3730.0	1.59	1.50	1.48	2.27	2.01	2.18	400.0	2.35	2.04	1.88
3780.0	1.62	1.54	1.53	2.30	2.04	2.16	447.1	2.55	2.20	2.01
3830.0	1.68	1.60	1.59	2.30	2.03	2.14	500.0	2.72	2.37	2.14
3980.0	1.92	1.87	1.87	2.49	2.06	2.14	600.0	3.38	2.88	2.58
4000.0	1.99	1.94	1.94	2.37	2.03	2.10	670.7	3.86	3.32	2.96
4030.0	2.08	2.04	2.03	2.40	2.03	2.08	700.0	3.95	3.50	3.11

REV. X1  
MBA-35MH  
060613  
Page 2 of 2



IF/RF MICROWAVE COMPONENTS • ISO 9001 ISO 14001 AS 9100 CERTIFIED RoHS compliant  
P.O. Box 350166, Brooklyn, New York 11235-0003 (718) 934-4500 Fax (718) 332-4661



The Design Engineers Search Engine finds the model you need, Instantly • For detailed performance specs & shopping online see



## Typical Performance Curves

### Conversion Loss

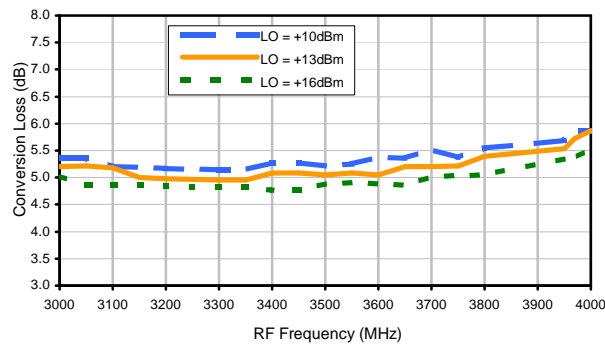

### LO-RF Isolation

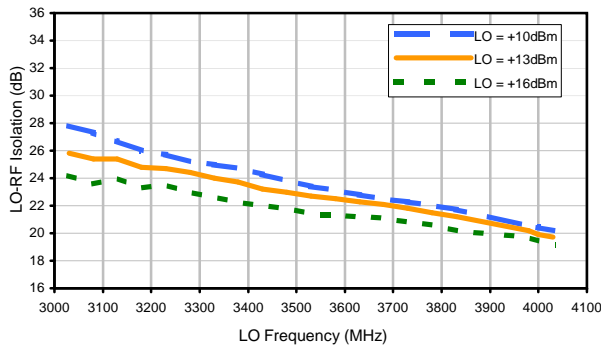

### LO-IF Isolation

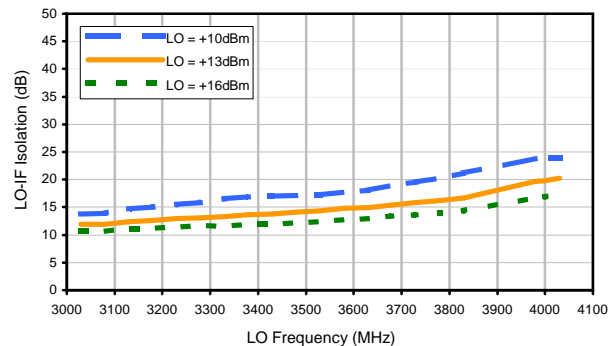

### RF VSWR

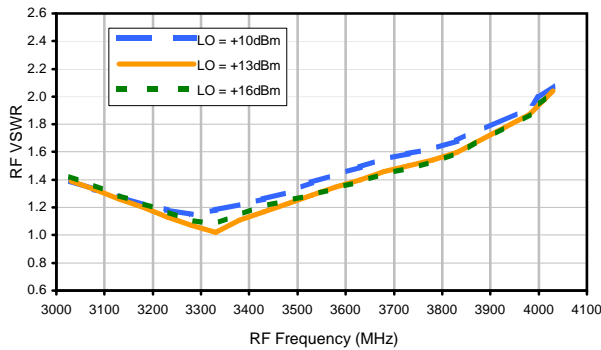

### LO VSWR

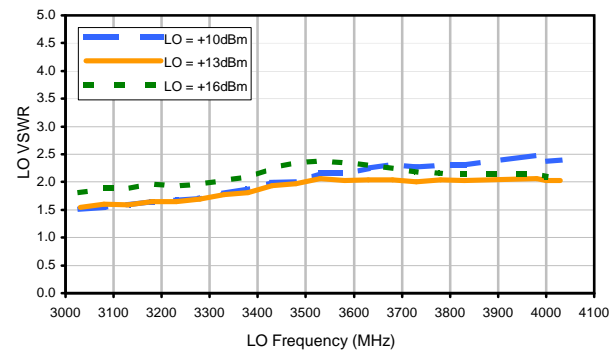

### IF VSWR

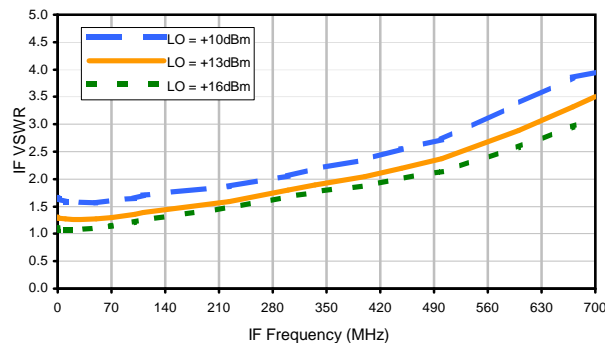

# Case Style

# SM2

SM2

## Outline Dimensions

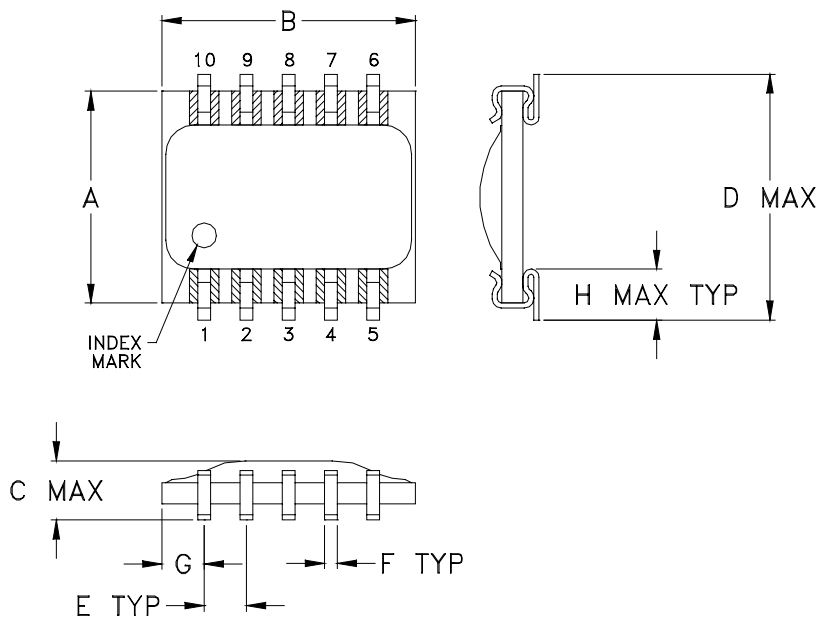

## PCB Land Pattern

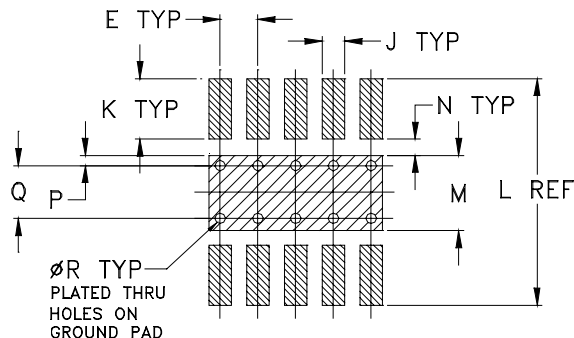

Suggested Layout,  
Tolerance to be within  $\pm .002$

ADJACENT GROUND PINS SHALL BE CONNECTED  
TO EACH OTHER AND TO GROUND PAD

CASE #	A	B	C	D	E	F	G	H	J	K	L	M	N	P
SM2	.250 (6.35)	.300 (7.62)	.095 (2.41)	.290 (7.37)	.050 (1.27)	.015 (0.38)	.050 (1.27)	.060 (1.52)	.030 (0.76)	.080 (2.03)	.300 (7.62)	.100 (2.54)	.020 (0.51)	.015 (0.38)

CASE #	Q	R	WT. GRAM
SM2	.070 (1.78)	.014 (0.36)	.3

Dimensions are in inches (mm). Tolerances:  $\pm .005$

### Notes:

1. Case material: Plastic encapsulation on Ceramic base.
2. Termination finish:  
For RoHS Case Styles: Tin plate over Nickel plate.  
For RoHS-5 Case Styles: Tin-Lead plate.



INTERNET <http://www.minicircuits.com>

P.O. Box 350166, Brooklyn, New York 11235-0003 (718) 934-4500 Fax (718) 332-4661

Distribution Centers NORTH AMERICA 800-654-7949 • 417-335-5935 • Fax 417-335-5945 • EUROPE 44-1252-832600 • Fax 44-1252-837010

Mini-Circuits ISO 9001 & ISO 14001 Certified

# Tape & Reel Packaging TR-F34

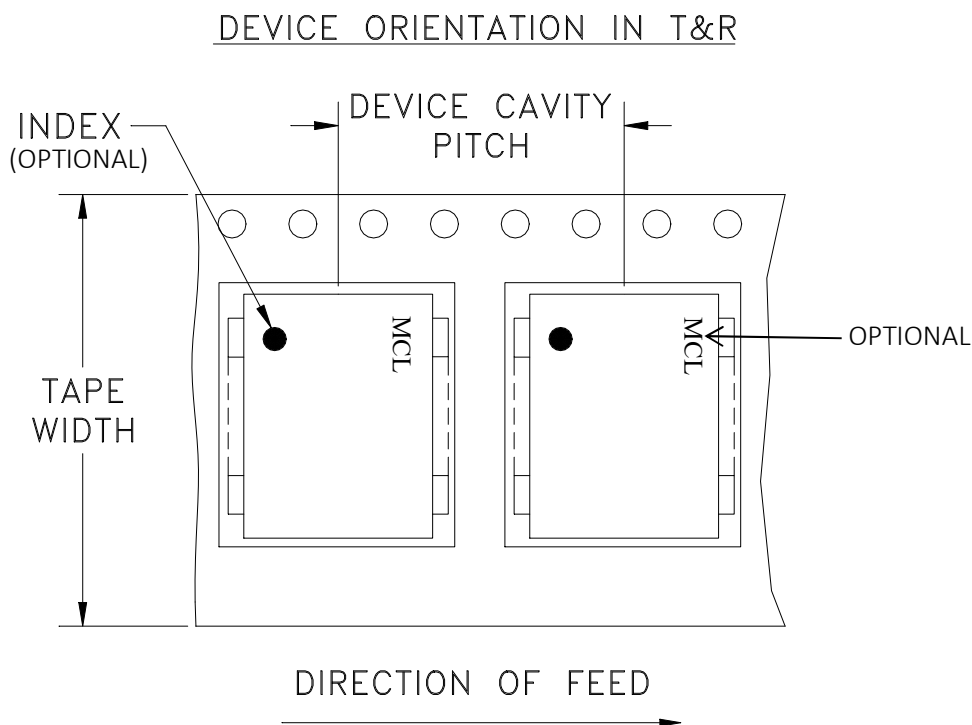

Tape Width, mm	Device Cavity Pitch, mm	Reel Size, inches	Devices per Reel see note	
16	12	7	Small quantity standard (see note)	20
				50
				100
				200
		13	Standard	500
				1000

Note: Availability of small reel quantity varies by model.  
Refer to pricing and availability on individual model dashboard.

Mini-Circuits carrier tape materials provide protection from ESD (Electro-Static Discharge) during handling and transportation. Tapes are static dissipative and comply with industry standards EIA-481/EIA-541.

Go to: [www.minicircuits.com/pages/pdfs/tape.pdf](http://www.minicircuits.com/pages/pdfs/tape.pdf)



INTERNET <http://www.minicircuits.com>

P.O. Box 350166, Brooklyn, New York 11235-0003 (718) 934-4500 Fax (718) 332-4661

Distribution Centers NORTH AMERICA 800-654-7949 • 417-335-5935 • Fax 417-335-5945 • EUROPE 44-1252-832600 • Fax 44-1252-837010

Mini-Circuits ISO 9001 & ISO 14001 Certified

THIRD ANGLE PROJECTION

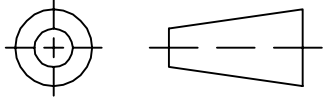

REVISIONS

REV	ECN No.	DESCRIPTION	DATE	DR	AUTH
OR	M82272	NEW RELEASE	08/02/02	GF	DJ
A	M102713	UPDATED NOTES, ADDED "...WITH SMOBC"	01/16/06	GT	IL

SUGGESTED MOUNTING CONFIGURATION FOR SM2 CASE STYLE, "Id" PIN CONNECTION

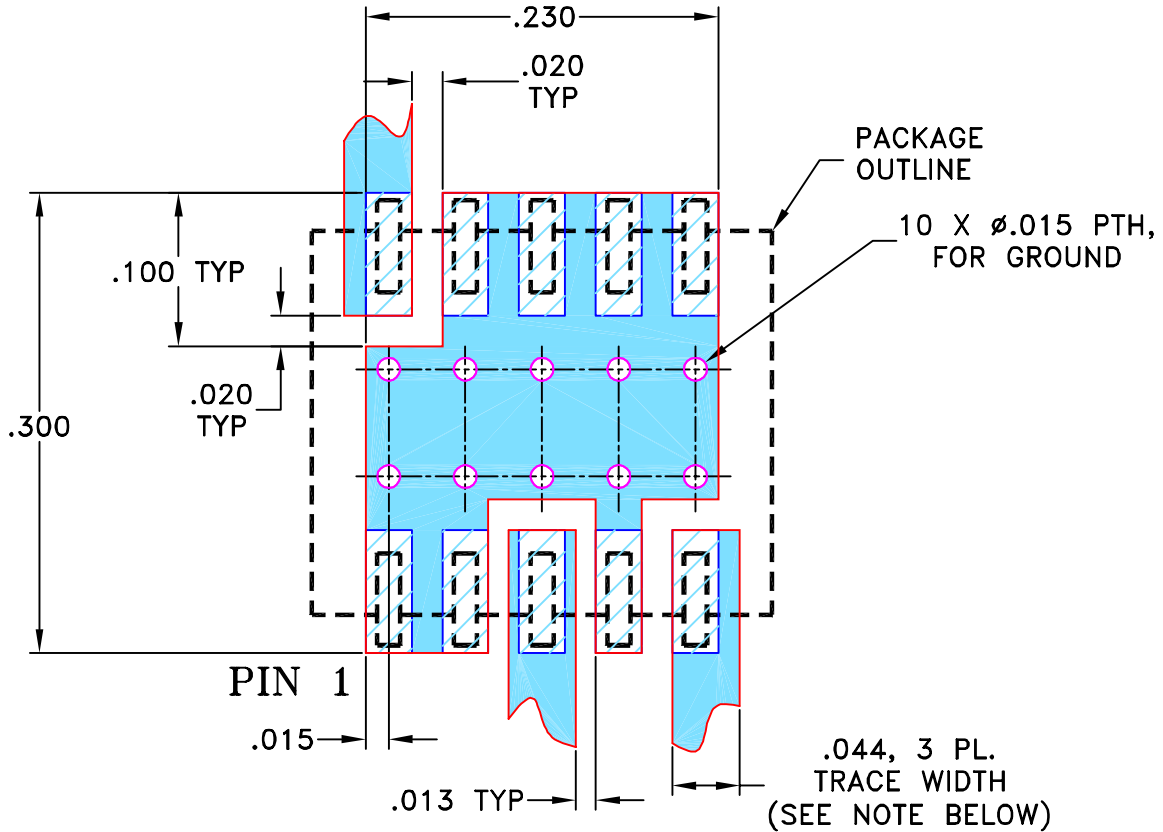

- NOTES: 1. TRACE WIDTH IS SHOWN FOR ROGERS RO4350B WITH DIELECTRIC THICKNESS 0.020" ± 0.0015". COPPER: 1/2 OZ. EACH SIDE. FOR OTHER MATERIALS TRACE WIDTH MAY NEED TO BE MODIFIED.

2. BOTTOM SIDE OF THE PCB IS CONTINUOUS GROUND PLANE.

 DENOTES PCB COPPER LAYOUT WITH SMOBC (SOLDER MASK OVER BARE COPPER)

 DENOTES COPPER LAND PATTERN FREE OF SOLDER MASK

UNLESS OTHERWISE SPECIFIED	INITIALS	DATE
DRAWN	GF	07/18/02
CHECKED	WL	08/02/02
APPROVED	DJ	08/02/02

 **Mini-Circuits**<sup>®</sup> 13 Neptune Avenue  
Brooklyn NY 11235

PL, Id, SM2, MBA, TB-99

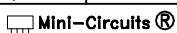
 Mini-Circuits<sup>®</sup>  
THIS DOCUMENT AND ITS CONTENTS ARE THE PROPERTY OF MINI-CIRCUITS. EXCEPT FOR USE EXPRESSLY GRANTED, IN WRITING, TO ITS VENDORS, VENDEE AND THE UNITED STATES GOVERNMENT, MINI-CIRCUITS RESERVES ALL PROPRIETARY DESIGN, USE, MANUFACTURING AND REPRODUCTION RIGHTS THERETO. THESE CONTENTS SHALL NOT BE USED, DUPLICATED OR DISCLOSED TO ANY OUTSIDE PARTY, IN WHOLE OR IN PART, WITHOUT WRITTEN PERMISSION OF MINI-CIRCUITS.

SIZE	CODE IDENT	DRAWING NO:	REV:
A	15542	98-PL-066	A
FILE:	98PL066	SCALE:	8:1
ASHEETA1.DWG REV:A	DATE:01/12/95	SHEET:	1 OF 1

# Evaluation Board and Circuit

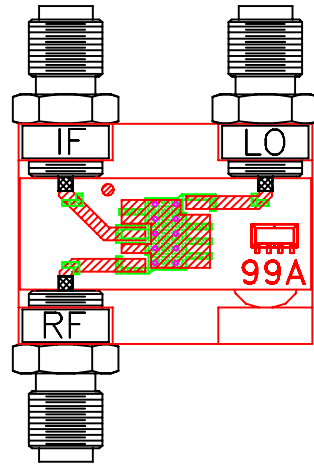

TB-99

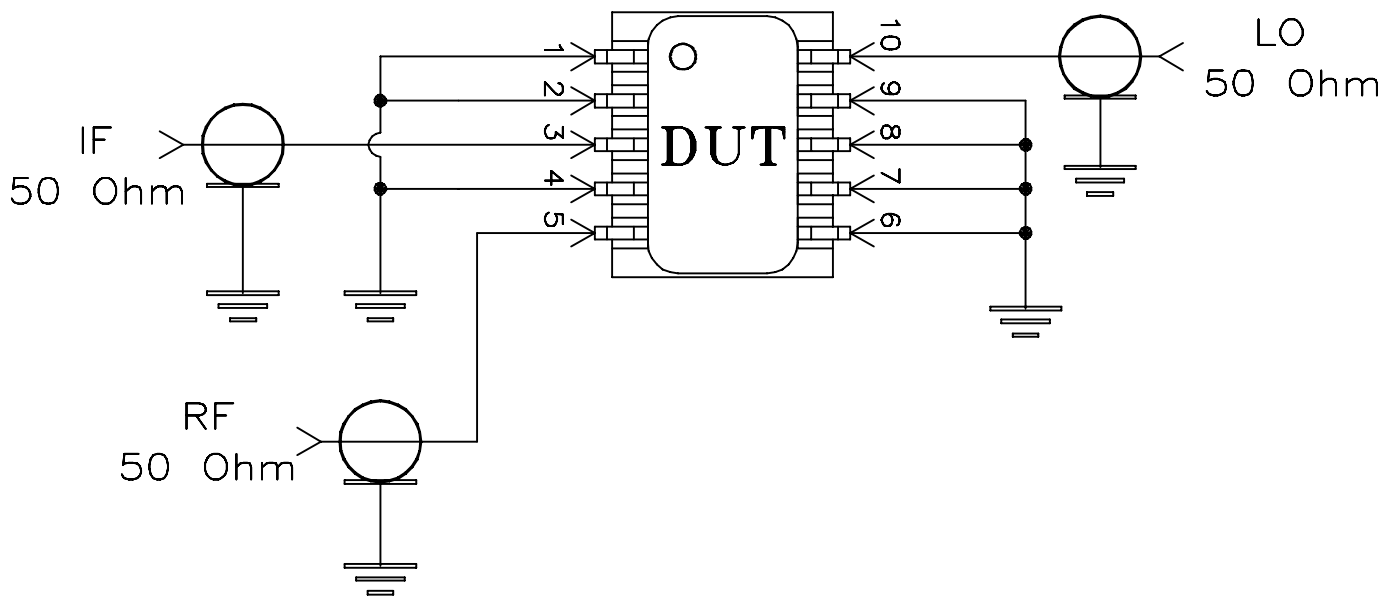

Schematic Diagram

## Notes:

1. SMA Female connectors.
2. PCB Material: Rogers R04350 or equivalent,  
Dielectric Constant=3.5, Thickness=.020 inch.

 Mini-Circuits®



All Mini-Circuits products are manufactured under exacting quality assurance and control standards, and are capable of meeting published specifications after being subjected to any or all of the following physical and environmental test.

Specification	Test/Inspection Condition	Reference/Spec
Operating Temperature	-40° to 85°C Ambient Environment	Individual Model Data Sheet
Storage Temperature	-55° to 100° C Ambient Environment	Individual Model Data Sheet
Humidity	90 to 95% RH, 240 hours, 50°C	MIL-STD-202, Method 103, Condition A, Except 50°C and end-point electrical test done within 12 hours
Thermal Shock	-55° to 100°C, 100 cycles	MIL-STD-202, Method 107, Condition A-3, except +100°C
Solder Reflow Heat	Sn-Pb Eutetic Process: 225°C peak Pb-Free Process 245° - 250°C peak	J-STD-020, Table 4-1, 4-2 and 5-2, Figure 5-1
Solderability	10X Magnification	J-STD-002, 95% Coverage
Vibration (High Frequency)	20g peak, 10-2000 Hz, 12 times in each of three perpendicular directions (total 36)	MIL-STD-202, Method 204, Condition D
Mechanical Shock	50g, 11 ms, 1/2-sine, 18 shocks: 3 each direction, each of 3 axes	MIL-STD-202, Method 213, Condition A
Marking Resistance to Solvents	Isopropyl alcohol + mineral spirits at 25°C; terpene defluxer at 25°C; distilled water + proylene glycol monomethyl ether + monoethanolamine at 63°C to 70°C	MIL-STD-202, Method 215