

Frequency Mixer WIDE BAND

MCA1T-80H+

Level 17 (LO Power+17 dBm) 2800 to 8000 MHz

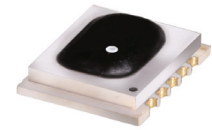

CASE STYLE: DZ885-2

Maximum Ratings

Operating Temperature	-40°C to 85°C
Storage Temperature	-40°C to 85°C
RF Power	200 mW
IF Current	40 mA
Permanent damage may occur if any of these limits are exceeded.	

Pin Connections

LO	10
RF	5
IF	3
GROUND	1,2,4,6,7,8,9

Outline Drawing

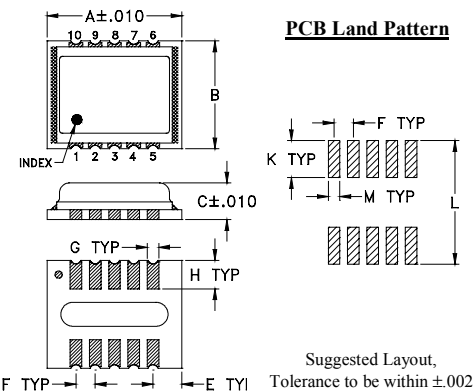

Outline Dimensions (inch/mm)

A	B	C	E	F	G
.350	.280	.095	.075	.050	.030
8.89	7.11	2.41	1.91	1.27	0.76
H	K	L	M	wt	
.074	.096	.321	.030	grams	
1.88	2.44	8.15	0.76	0.21	

Demo Board MCL P/N: TB-493+ Suggested PCB Layout (PL-288)

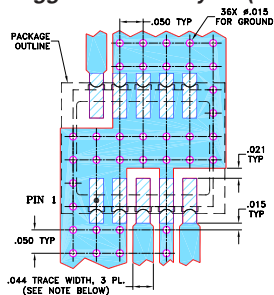

- NOTES: 1. TRACE WIDTH IS SHOWN FOR ROGERS RO4350B WITH DIELECTRIC THICKNESS .020" ± .0015"; COPPER: 1/2 OZ. EACH SIDE. FOR OTHER MATERIALS TRACE WIDTH MAY NEED TO BE MODIFIED.
 2. BOTTOM SIDE OF THE PCB IS CONTINUOUS GROUND PLANE.

Notes

- A. Performance and quality attributes and conditions not expressly stated in this specification document are intended to be excluded and do not form a part of this specification document.
 B. Electrical specifications and performance data contained in this specification document are based on Mini-Circuits' applicable established test performance criteria and measurement instructions.
 C. The parts covered by this specification document are subject to Mini-Circuits standard limited warranty and terms and conditions (collectively, "Standard Terms"); Purchasers of this part are entitled to the rights and benefits contained therein. For a full statement of the Standard Terms and the exclusive rights and remedies thereunder, please visit Mini-Circuits' website at www.minicircuits.com/MCLStore/terms.jsp

Features

- wide bandwidth, 2800 to 8000 MHz
- low conversion loss, 6.3 dB typ.
- high L-R isolation, 35 dB typ.
- IF, DC to 1250 MHz
- LTCC double balanced mixer
- aqueous washable
- low cost
- low profile, 0.095"
- protected by US Patent 7,027,795 & 8,749,989

Applications

- satellite up and down converters
- line of sight links
- defense radar
- defense communication

Electrical Specifications (T_{AMB} = -40°C to 85°C)

FREQUENCY (MHz)	CONVERSION LOSS (dB)			LO-RF ISOLATION (dB)		LO-IF ISOLATION (dB)		IP3 at center band (dBm)
	LO/RF f _L -f _U	IF	\bar{X} σ Max.	Typ.	Min.	Typ.	Min.	
2800-8000	DC-1250		6.5 0.2 8.9*	34	22	12	8	24
2800-5000	DC-1250							
5000-8000	DC-1250		6.0 0.2 8.9*	35	21	35	13	21

1 dB COMPR. +14 dBm typ.
 * Conversion loss at 30 MHz IF, increases with IF frequency.

Typical Performance Data

Frequency (MHz)	Conversion Loss (dB)	Isolation L-R (dB)	Isolation L-I (dB)	VSWR RF Port (:1)	VSWR LO Port (:1)
2800.00	6.13	41.00	11.93	2.36	2.36
5000.00	6.65	36.29	27.03	2.63	2.63
6200.00	6.86	35.62	38.03	2.95	2.95
6300.00	6.57	36.43	39.57	2.92	2.92
6400.00	6.41	41.37	41.68	2.95	2.95
6500.00	6.30	39.86	44.02	3.22	3.22
6600.00	6.55	36.15	45.57	3.24	3.24
6650.00	6.54	35.67	47.07	3.28	3.28
6700.00	6.39	35.84	47.65	3.28	3.28
7000.00	6.17	33.43	45.36	3.41	3.41
7150.00	6.39	34.29	42.31	3.46	3.46
7200.00	6.23	35.27	42.14	3.55	3.55
7300.00	6.23	34.89	41.25	3.64	3.64
7400.00	6.29	33.13	39.47	3.75	3.75
7500.00	6.39	32.66	35.70	3.78	3.78
7600.00	6.54	34.37	31.19	3.74	3.74
7700.00	6.48	34.16	27.04	3.65	3.65
7800.00	6.48	36.44	22.80	3.62	3.62
7900.00	6.48	33.88	19.30	3.54	3.54
8000.00	6.46	30.03	17.69	3.59	3.59

Electrical Schematic

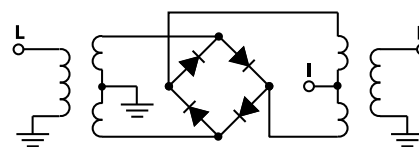

NON-CATALOG

Performance Charts

MCA1T-80H+

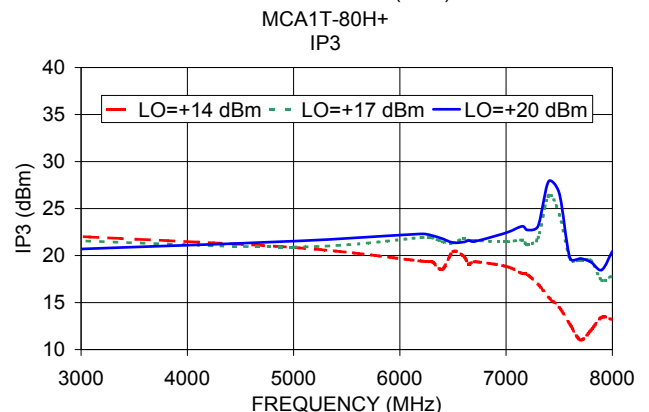
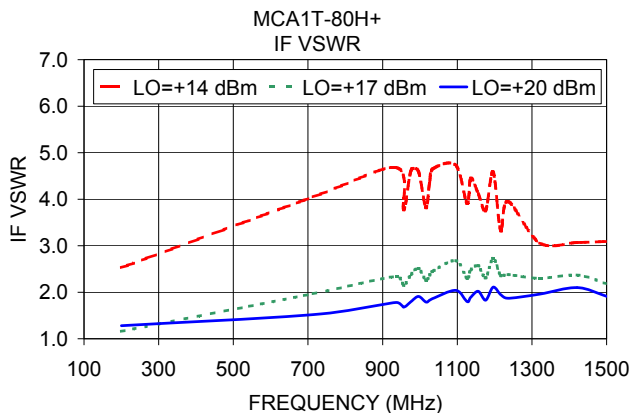
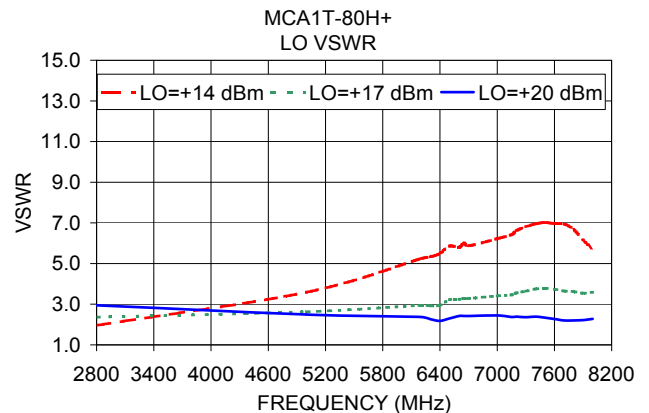
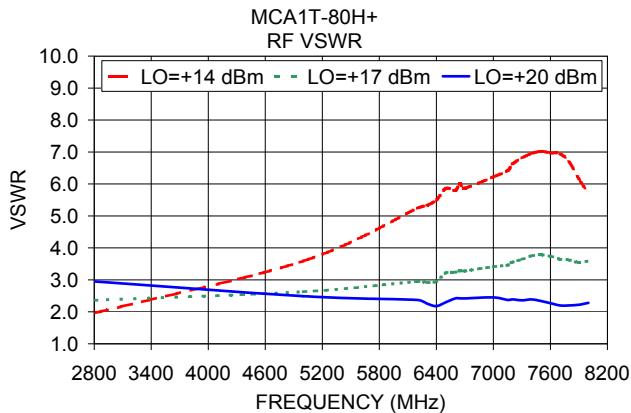
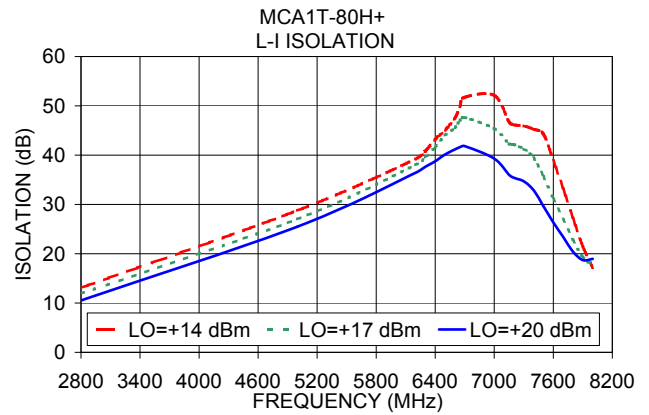
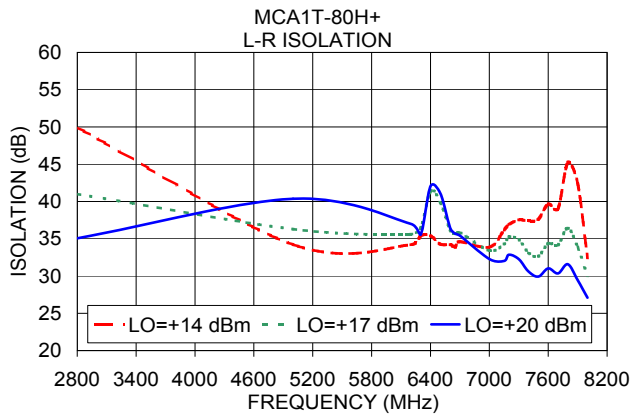
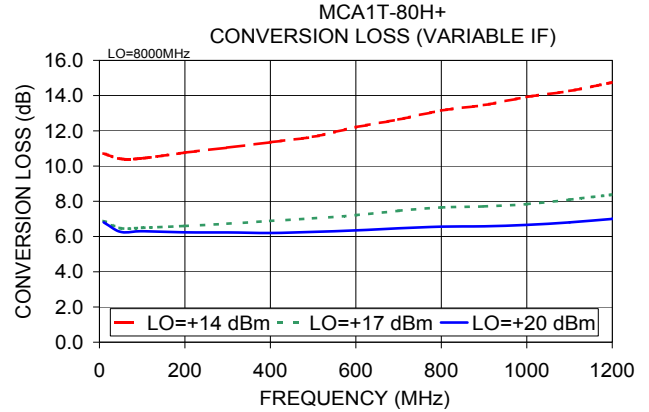
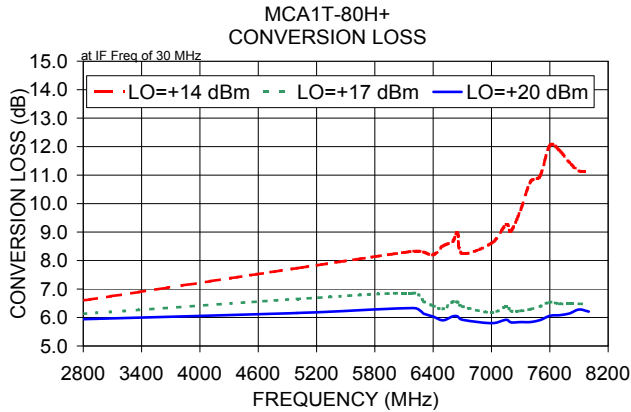

A. Performance and quality attributes and conditions not expressly stated in this specification document are intended to be excluded and do not form a part of this specification document.
 B. Electrical specifications and performance data contained in this specification document are based on Mini-Circuit's applicable established test performance criteria and measurement instructions.
 C. The parts covered by this specification document are subject to Mini-Circuits standard limited warranty and terms and conditions (collectively, "Standard Terms"); Purchasers of this part are entitled to the rights and benefits contained therein. For a full statement of the Standard Terms and the exclusive rights and remedies thereunder, please visit Mini-Circuits' website at www.minicircuits.com/MCLStore/terms.jsp



Frequency Mixer

MCA1T-80H+

Typical Performance Data

RF (IN) (MHz)	LO (MHz)	CONVERSION LOSS IF FIXED @IF(OUT)=30.1MHz (dB)			RF (IN) (MHz)	LO (MHz)	IP3 INPUT (dBm)			RF (IN) (MHz)	LO (MHz)	COMPRESSION @RF IN=+14dBm (dB)		
		@LO (dBm)					@LO (dBm)					@LO (dBm)		
		+14	+17	+20			+14	+17	+20			+14	+17	+20
2530.0	2560.1	7.69	6.94	6.48	2530.0	2560.1	22.51	21.57	20.36	2530.0	2560.1	1.71	1.59	1.68
2680.0	2710.1	7.00	6.47	6.13	2680.0	2710.1	21.86	20.76	19.82	2680.0	2710.1	1.79	1.55	1.52
2896.0	2926.1	6.46	5.99	5.76	2896.0	2926.1	23.06	24.07	24.81	2896.0	2926.1	1.66	1.35	1.25
3056.0	3086.1	6.30	5.81	5.51	3056.0	3086.1	23.10	24.79	26.34	3056.0	3086.1	1.54	1.19	1.08
3216.0	3246.1	5.96	5.46	5.18	3216.0	3246.1	21.21	22.88	23.64	3216.0	3246.1	1.75	1.36	1.15
3376.0	3406.1	5.71	5.31	5.11	3376.0	3406.1	20.76	23.42	25.10	3376.0	3406.1	1.92	1.19	0.96
3536.0	3566.1	5.62	5.26	5.12	3536.0	3566.1	21.55	25.59	27.50	3536.0	3566.1	1.85	0.86	0.61
3696.0	3726.1	5.45	5.11	5.02	3696.0	3726.1	21.65	24.31	24.85	3696.0	3726.1	1.74	0.73	0.54
3856.0	3886.1	5.90	5.47	5.38	3856.0	3886.1	20.42	24.19	26.38	3856.0	3886.1	1.66	0.64	0.27
4090.0	4120.1	8.26	7.03	6.62	4090.0	4120.1	26.26	32.24	31.61	4090.0	4120.1	1.42	1.08	0.75
4250.0	4280.1	8.91	7.67	7.06	4250.0	4280.1	24.63	26.03	26.45	4250.0	4280.1	0.86	0.78	0.80
4410.0	4440.1	8.46	7.49	6.84	4410.0	4440.1	23.95	23.36	25.04	4410.0	4440.1	0.98	0.50	0.45
4570.0	4600.1	8.26	7.07	6.54	4570.0	4600.1	23.06	22.39	24.71	4570.0	4600.1	1.12	0.61	0.34
4880.0	4910.1	8.14	7.16	6.46	4880.0	4910.1	20.95	21.01	22.28	4880.0	4910.1	0.78	0.52	0.55
5060.0	5090.1	7.85	6.61	6.12	5060.0	5090.1	20.23	20.56	21.10	5060.0	5090.1	0.91	0.47	0.49
5220.0	5250.1	7.55	6.47	5.89	5220.0	5250.1	18.98	20.65	21.22	5220.0	5250.1	1.06	0.46	0.46
5380.0	5410.1	7.12	6.26	5.79	5380.0	5410.1	18.74	20.82	21.94	5380.0	5410.1	1.27	0.61	0.51
5630.0	5660.1	7.58	6.24	5.88	5630.0	5660.1	18.78	23.41	24.45	5630.0	5660.1	0.98	0.60	0.36
5790.0	5820.1	7.71	6.32	5.94	5790.0	5820.1	22.55	28.53	27.76	5790.0	5820.1	0.77	0.52	0.28
5950.0	5980.1	9.22	7.30	6.55	5950.0	5980.1	24.04	24.50	23.83	5950.0	5980.1	0.16	0.39	0.45
6110.0	6140.1	8.54	7.06	6.46	6110.0	6140.1	20.47	22.51	22.62	6110.0	6140.1	0.51	0.42	0.49
6270.0	6300.1	8.10	6.62	6.18	6270.0	6300.1	19.63	22.25	22.55	6270.0	6300.1	0.63	0.54	0.62
6430.0	6460.1	8.35	6.39	6.01	6430.0	6460.1	18.73	21.43	21.81	6430.0	6460.1	0.41	0.53	0.57
6590.0	6620.1	8.59	6.53	6.02	6590.0	6620.1	20.16	21.84	21.45	6590.0	6620.1	0.35	0.44	0.51
6750.0	6780.1	9.00	6.48	6.00	6750.0	6780.1	19.33	21.74	21.88	6750.0	6780.1	0.00	0.42	0.48
6910.0	6940.1	8.92	6.29	5.89	6910.0	6940.1	18.84	21.56	22.51	6910.0	6940.1	0.05	0.59	0.63
7060.0	7090.1	8.52	6.31	5.86	7060.0	7090.1	19.49	21.54	22.84	7060.0	7090.1	0.08	0.45	0.58
7220.0	7250.1	10.49	6.43	5.94	7220.0	7250.1	14.92	21.20	23.31	7220.0	7250.1	-1.30	0.55	0.67
7380.0	7410.1	9.29	6.07	5.74	7380.0	7410.1	18.08	21.96	22.53	7380.0	7410.1	-0.45	0.67	0.80
7540.0	7570.1	10.75	6.46	6.00	7540.0	7570.1	15.44	22.29	23.04	7540.0	7570.1	-1.51	0.52	0.74
7700.0	7730.1	11.86	6.48	6.08	7700.0	7730.1	12.16	19.77	20.01	7700.0	7730.1	-2.39	0.76	0.99
7860.0	7890.1	10.18	6.33	6.21	7860.0	7890.1	15.92	19.00	18.75	7860.0	7890.1	-0.87	0.93	0.90
8040.0	8070.1	11.02	6.37	6.15	8040.0	8070.1	13.04	19.94	23.28	8040.0	8070.1	-1.49	0.90	0.70
8200.0	8230.1	9.83	6.16	5.95	8200.0	8230.1	17.24	24.14	26.44	8200.0	8230.1	-0.50	0.89	0.61
8360.0	8390.1	8.75	5.99	5.86	8360.0	8390.1	20.35	24.97	25.99	8360.0	8390.1	0.16	0.71	0.40
8520.0	8550.1	8.94	6.21	6.05	8520.0	8550.1	16.35	22.64	30.28	8520.0	8550.1	0.56	1.06	0.45
8680.0	8710.1	9.18	6.77	6.30	8680.0	8710.1	15.49	27.80	25.49	8680.0	8710.1	0.67	1.10	0.98
8840.0	8870.1	10.36	7.77	6.84	8840.0	8870.1	18.48	26.57	24.84	8840.0	8870.1	0.19	0.94	1.24
9000.0	9030.1	9.70	8.68	7.73	9000.0	9030.1	24.65	24.75	23.96	9000.0	9030.1	1.19	0.84	1.39

Frequency Mixer

MCA1T-80H+

Typical Performance Data

IF (OUT) (MHz)	LO (MHz)	CONVERSION LOSS VS. IF FREQUENCY @RF(IN)=5400MHz (dB)
		@LO (dBm)
		+17
2220.0	3180.0	9.76
2158.0	3242.0	9.97
2094.0	3306.0	9.80
2030.0	3370.0	9.83
1881.0	3519.0	10.80
1785.0	3615.0	10.65
1689.0	3711.0	10.35
1596.0	3804.0	9.88
1500.0	3900.0	9.73
1384.0	4016.0	9.87
1288.0	4112.0	9.10
1115.0	4285.0	8.59
1019.0	4381.0	7.98
923.0	4477.0	7.56
830.0	4570.0	7.18
734.0	4666.0	6.90
638.0	4762.0	6.66
442.0	4958.0	5.94
269.2	5130.8	5.95
96.4	5303.6	6.21
10.0	5410.0	6.85
72.0	5472.0	6.27
136.0	5536.0	6.27
200.0	5600.0	6.24
264.0	5664.0	6.10
416.0	5816.0	5.94
480.0	5880.0	6.06
542.0	5942.0	6.31
710.0	6110.0	6.85
774.0	6174.0	7.17
892.0	6292.0	8.13
1020.0	6420.0	8.51
1148.0	6548.0	9.19
1276.0	6676.0	9.88
1400.0	6800.0	10.18
1528.0	6928.0	11.94
1656.0	7056.0	11.39
1784.0	7184.0	12.29
1912.0	7312.0	10.60
2040.0	7440.0	11.24

IF (OUT) (MHz)	LO (MHz)	CONVERSION LOSS VS. IF FREQUENCY @RF(IN)=2800MHz (dB)
		@LO (dBm)
		+17
10.0	2810.0	6.59
40.0	2840.0	6.11
72.0	2872.0	6.16
104.0	2904.0	6.16
136.0	2936.0	6.09
168.0	2968.0	6.19
200.0	3000.0	6.15
232.0	3032.0	6.12
264.0	3064.0	6.13
296.0	3096.0	6.15
328.0	3128.0	6.17
360.0	3160.0	6.25
392.0	3192.0	6.20
424.0	3224.0	6.16
454.0	3254.0	6.19
486.0	3286.0	6.16
518.0	3318.0	6.21
550.0	3350.0	6.25
695.0	3495.0	6.30
775.0	3575.0	6.11
855.0	3655.0	5.96
935.0	3735.0	6.13
1015.0	3815.0	6.41
1095.0	3895.0	6.63
1175.0	3975.0	6.84
1271.0	4071.0	7.43
1380.0	4180.0	7.89
1455.0	4255.0	8.08
1535.0	4335.0	8.79
1615.0	4415.0	9.01
1695.0	4495.0	9.30
1775.0	4575.0	9.96
1855.0	4655.0	9.26
1935.0	4735.0	9.72
2070.0	4870.0	8.34
2150.0	4950.0	8.76
2230.0	5030.0	8.43
2310.0	5110.0	8.68
2390.0	5190.0	9.13
2470.0	5270.0	9.70

IF (OUT) (MHz)	LO (MHz)	CONVERSION LOSS VS. IF FREQUENCY @RF(IN)=8000MHz (dB)
		@LO (dBm)
		+17
2220.0	5780.0	9.01
2175.0	5825.0	9.09
2127.0	5873.0	9.42
2079.0	5921.0	9.78
1952.0	6048.0	10.93
1872.0	6128.0	11.35
1792.0	6208.0	11.84
1712.0	6288.0	11.10
1632.0	6368.0	11.71
1552.0	6448.0	9.92
1472.0	6528.0	10.55
1392.0	6608.0	9.07
1312.0	6688.0	9.68
1205.0	6795.0	8.90
1130.0	6870.0	7.99
1050.0	6950.0	8.09
970.0	7030.0	7.26
890.0	7110.0	7.15
810.0	7190.0	7.04
730.0	7270.0	6.94
650.0	7350.0	6.88
584.0	7416.0	6.68
552.0	7448.0	6.74
520.0	7480.0	6.54
488.0	7512.0	6.56
456.0	7544.0	6.65
424.0	7576.0	6.37
394.0	7606.0	6.41
362.0	7638.0	6.46
330.0	7670.0	6.25
298.0	7702.0	6.32
266.0	7734.0	6.35
234.0	7766.0	6.15
202.0	7798.0	6.25
170.0	7830.0	6.30
138.0	7862.0	6.19
106.0	7894.0	6.29
74.0	7926.0	6.30
42.0	7958.0	6.30
10.0	7990.0	6.97

Frequency Mixer

MCA1T-80H+

Typical Performance Data

LO (MHz)	LO-RF ISOLATION (dB)			LO-IF ISOLATION (dB)		
	@LO (dBm)			@LO (dBm)		
	+14	+17	+20	+14	+17	+20
2560.0	43.13	41.48	41.65	8.24	8.39	8.02
2710.0	40.63	36.43	34.33	11.26	10.75	9.72
2926.0	46.13	40.54	37.22	14.12	12.64	11.29
3086.0	48.04	41.19	37.76	14.20	12.99	11.99
3246.0	39.51	50.88	46.08	14.03	13.18	12.35
3406.0	34.53	39.75	39.53	13.46	13.26	12.83
3566.0	31.76	33.61	33.97	12.31	12.84	13.09
3726.0	28.34	29.02	29.75	11.56	12.48	13.08
3886.0	26.64	29.29	31.46	10.58	11.95	13.23
4120.0	22.50	26.11	30.94	10.37	12.03	13.67
4280.0	21.49	24.90	30.27	12.21	14.08	15.75
4440.0	22.86	25.76	35.70	15.05	16.99	18.39
4600.0	25.28	27.80	33.79	18.70	20.11	21.12
4910.0	32.82	38.14	44.13	26.00	25.53	24.62
5090.0	35.10	36.06	37.26	30.02	27.56	25.61
5250.0	44.25	44.43	44.08	32.65	29.17	27.01
5410.0	42.34	40.63	44.26	33.70	30.05	27.91
5660.0	46.08	49.86	47.70	35.12	32.36	30.32
5820.0	44.12	53.10	58.18	35.47	33.78	31.96
5980.0	36.41	38.54	39.45	36.79	35.43	33.94
6140.0	34.01	36.14	38.15	38.06	36.90	35.43
6300.0	33.40	34.25	34.36	40.23	39.03	37.27
6460.0	35.91	42.03	41.58	43.82	42.31	39.01
6620.0	34.28	36.62	37.10	47.32	45.50	41.16
6780.0	33.62	34.78	34.79	56.10	49.11	41.96
6940.0	33.64	34.05	33.53	57.36	47.58	40.78
7090.0	34.71	33.85	32.16	48.81	43.62	37.56
7250.0	38.63	35.53	32.68	46.08	42.70	35.27
7410.0	36.38	32.61	30.09	45.59	39.15	33.04
7570.0	37.05	32.50	29.89	41.52	32.76	27.22
7730.0	39.03	34.16	30.35	33.28	27.04	23.45
7890.0	40.20	33.71	30.02	23.33	20.46	19.27
8070.0	30.48	30.27	26.93	16.10	17.82	19.89
8230.0	25.51	28.45	25.36	17.07	19.30	21.46
8390.0	23.07	25.04	23.69	19.57	21.47	23.00
8550.0	22.49	24.42	25.40	20.67	22.32	23.77
8710.0	19.85	20.71	21.18	21.40	23.20	24.61
8870.0	18.96	19.15	19.52	21.71	23.43	25.02
9030.0	17.30	17.64	17.69	21.85	23.71	25.46

RF (IN) (MHz)	LO (MHz)	RF-IF ISOLATION (dB)		
		@LO (dBm)		
		+14	+17	+20
2530.0	2560.0	45.87	37.16	34.62
2680.0	2710.0	29.45	26.88	25.27
2896.0	2926.0	26.09	23.60	21.88
3056.0	3086.0	23.56	21.95	20.63
3216.0	3246.0	20.50	19.51	18.68
3376.0	3406.0	18.28	17.34	16.59
3536.0	3566.0	16.21	15.21	14.57
3696.0	3726.0	14.35	13.68	13.16
3856.0	3886.0	12.72	12.36	12.07
4090.0	4120.0	10.48	10.88	10.99
4250.0	4280.0	8.26	8.85	9.11
4410.0	4440.0	8.56	9.19	9.44
4570.0	4600.0	10.03	10.85	11.30
4880.0	4910.0	11.84	12.27	12.59
5060.0	5090.0	13.39	13.98	14.50
5220.0	5250.0	15.08	15.62	16.16
5380.0	5410.0	16.56	17.16	17.67
5630.0	5660.0	19.92	20.48	20.85
5790.0	5820.0	21.56	21.56	21.54
5950.0	5980.0	24.84	24.80	24.58
6110.0	6140.0	28.13	27.99	27.66
6270.0	6300.0	30.38	29.21	28.57
6430.0	6460.0	30.99	28.93	27.89
6590.0	6620.0	29.25	27.92	27.15
6750.0	6780.0	26.65	25.81	25.20
6910.0	6940.0	24.69	24.57	24.26
7060.0	7090.0	23.15	23.37	23.34
7220.0	7250.0	21.45	22.44	22.73
7380.0	7410.0	19.96	21.41	22.00
7540.0	7570.0	19.60	21.87	23.19
7700.0	7730.0	17.72	20.21	21.48
7860.0	7890.0	17.67	20.72	22.95
8040.0	8070.0	18.65	23.75	26.38
8200.0	8230.0	26.68	24.14	25.47
8360.0	8390.0	23.19	22.82	23.95
8520.0	8550.0	21.68	22.36	23.66
8680.0	8710.0	20.51	21.32	22.24
8840.0	8870.0	21.34	21.96	22.58
9000.0	9030.0	22.52	23.04	23.45

Frequency Mixer

MCA1T-80H+

Typical Performance Data

RF (IN) (MHz)	LO (MHz)	RF VSWR (:1)			LO (MHz)	LO VSWR (:1)			IF (OUT) (MHz)	IF VSWR @LO=8000MHz (:1)		
		@LO (dBm)				@LO (dBm)				@LO (dBm)		
		+14	+17	+20		+14	+17	+20		+14	+17	+20
2530.0	2560.0	3.73	3.12	2.77	2560.0	2.43	2.39	2.69	11.0	2.58	1.13	1.19
2680.0	2710.0	3.19	2.67	2.35	2710.0	2.18	2.42	2.90	176.0	2.49	1.09	1.26
2896.0	2926.0	3.01	2.53	2.17	2926.0	1.88	2.34	2.98	208.0	2.48	1.14	1.31
3056.0	3086.0	2.60	2.25	1.99	3086.0	1.60	2.14	2.78	240.0	2.59	1.19	1.24
3216.0	3246.0	2.34	1.97	1.75	3246.0	1.47	2.06	2.77	272.0	2.60	1.17	1.24
3376.0	3406.0	1.99	1.66	1.48	3406.0	1.34	1.95	2.67	304.0	2.70	1.24	1.23
3536.0	3566.0	1.71	1.42	1.26	3566.0	1.37	1.84	2.47	336.0	2.77	1.28	1.23
3696.0	3726.0	1.80	1.50	1.31	3726.0	1.58	1.92	2.58	368.0	2.81	1.28	1.21
3856.0	3886.0	1.60	1.37	1.24	3886.0	1.86	1.93	2.42	400.0	2.95	1.36	1.21
4090.0	4120.0	2.34	2.10	1.95	4120.0	2.23	2.18	2.61	536.0	3.25	1.56	1.32
4250.0	4280.0	1.94	1.84	1.78	4280.0	2.50	2.29	2.57	568.0	3.43	1.59	1.30
4410.0	4440.0	1.97	1.77	1.68	4440.0	2.77	2.44	2.64	600.0	3.54	1.69	1.33
4570.0	4600.0	2.03	1.72	1.55	4600.0	3.02	2.53	2.65	632.0	3.63	1.76	1.43
4880.0	4910.0	2.61	2.27	2.09	4910.0	3.39	2.56	2.58	694.0	3.61	1.82	1.43
5060.0	5090.0	2.60	2.17	1.90	5090.0	3.72	2.68	2.49	726.0	4.17	2.02	1.57
5220.0	5250.0	2.57	2.18	1.88	5250.0	3.75	2.67	2.46	758.0	3.90	1.89	1.47
5380.0	5410.0	2.41	2.02	1.75	5410.0	3.87	2.62	2.45	790.0	4.13	2.07	1.58
5630.0	5660.0	2.58	1.99	1.68	5660.0	4.30	2.64	2.24	822.0	4.45	2.19	1.68
5790.0	5820.0	2.61	2.05	1.80	5820.0	4.45	2.71	2.27	854.0	3.80	2.01	1.57
5950.0	5980.0	3.27	2.65	2.30	5980.0	5.03	2.99	2.38	886.0	4.66	2.32	1.74
6110.0	6140.0	3.40	2.83	2.50	6140.0	5.21	3.01	2.43	918.0	4.30	2.27	1.75
6270.0	6300.0	3.38	2.71	2.40	6300.0	5.17	2.89	2.29	950.0	3.99	2.21	1.71
6430.0	6460.0	3.31	2.51	2.17	6460.0	5.71	3.03	2.19	982.0	4.80	2.46	1.84
6590.0	6620.0	3.42	2.64	2.26	6620.0	5.76	3.24	2.43	1014.0	3.76	2.25	1.79
6750.0	6780.0	3.49	2.61	2.26	6780.0	6.24	3.39	2.48	1046.0	4.57	2.47	1.88
6910.0	6940.0	3.38	2.44	2.14	6940.0	6.26	3.41	2.46	1078.0	4.37	2.43	1.85
7060.0	7090.0	3.16	2.37	2.05	7090.0	6.26	3.39	2.40	1108.0	3.79	2.46	1.96
7220.0	7250.0	3.41	2.25	1.91	7250.0	6.88	3.67	2.39	1140.0	4.55	2.54	1.93
7380.0	7410.0	3.06	2.08	1.78	7410.0	6.58	3.57	2.34	1172.0	3.55	2.27	1.82
7540.0	7570.0	3.12	2.06	1.74	7570.0	6.68	3.56	2.25	1204.0	4.28	2.72	2.15
7700.0	7730.0	3.37	2.04	1.71	7730.0	6.95	3.65	2.20	1250.0	4.37	2.67	2.09
7860.0	7890.0	2.95	1.94	1.58	7890.0	6.11	3.40	2.14	1381.0	2.87	2.15	1.86
8040.0	8070.0	2.86	1.74	1.44	8070.0	5.64	3.64	2.27	1541.0	2.42	1.89	1.71
8200.0	8230.0	2.67	1.57	1.33	8230.0	5.70	3.59	2.26	1701.0	2.06	1.72	1.63
8360.0	8390.0	2.31	1.43	1.21	8390.0	5.43	3.34	2.09	1861.0	1.78	1.52	1.48
8520.0	8550.0	2.04	1.37	1.08	8550.0	5.12	3.10	1.94	2021.0	1.51	1.46	1.53
8680.0	8710.0	2.22	1.66	1.37	8710.0	4.25	2.53	1.65	2181.0	1.32	1.57	1.72
8840.0	8870.0	2.47	1.94	1.58	8870.0	3.36	2.07	1.42	2341.0	1.29	1.69	1.90
9000.0	9030.0	2.48	2.24	1.86	9030.0	2.35	1.57	1.24	2501.0	1.39	1.99	2.31

Harmonics Tables

RF HARMONICS ORDER

	(-dBm)	(-dBc)										
0	-	-	7	27	14	45	---	---	---	---	---	---
1	-	12	+0	35	31	50	54	---	---	---	---	---
2	65	64	76	50	60	60	54	58	---	---	---	---
3	>90	76	65	75	62	73	69	76	79	---	---	---
4	>90	>83	>83	>83	>83	>83	>83	>83	>83	>83	---	---
5	---	---	>83	>83	>83	>83	>83	>83	>83	>83	>83	---
6	---	---	---	82	>83	>83	>83	>83	>83	>83	>83	>83
7	---	---	---	---	>83	>83	>83	>83	>83	>83	>83	>83
8	---	---	---	---	---	>83	>83	>83	>83	>83	>83	>83
9	---	---	---	---	---	---	>83	>83	>83	>83	>83	>83
10	---	---	---	---	---	---	---	>83	>83	>83	>83	>83
	RF CAL	0	1	2	3	4	5	6	7	8	9	10

Test conditions: RF IN: 5400 MHz; -1.00 dBm.
 LO IN: 5430 MHz; +17.00 dBm
 IF OUT: 30 MHz; -7.4 dBm

RF HARMONICS ORDER

	(-dBm)	(-dBc)										
0	-	-	16	39	26	47	---	---	---	---	---	---
1	-	12	+0	37	31	52	62	---	---	---	---	---
2	46	52	64	44	53	51	48	55	---	---	---	---
3	63	55	45	57	41	56	55	61	70	---	---	---
4	76	65	72	66	70	58	69	64	67	64	---	---
5	---	---	88	82	73	78	60	76	65	73	81	---
6	---	---	---	>92	87	83	81	76	84	76	86	79
7	---	---	---	---	>92	>92	84	86	77	90	78	>92
8	---	---	---	---	---	>92	>92	>92	>92	81	>92	85
9	---	---	---	---	---	---	>92	>92	>92	>92	88	>92
10	---	---	---	---	---	---	---	>92	>92	>92	>92	>92
	RF CAL	0	1	2	3	4	5	6	7	8	9	10

LO HARMONICS ORDER

Test conditions: RF IN: 5400 MHz; 9.00 dBm.
 LO IN: 5430 MHz; +17.00 dBm
 IF OUT: 30 MHz; 2.37 dBm

- Notes: 1. All Harmonics are in (dBc) relative to IF OUTPUT.
 2. + entry denotes harmonics are in (dBc) above IF OUTPUT.
 3. RF Cal represent the Harmonics level of the RF input signal to the mixer.

Typical Performance Curves

Conversion Loss @IF=30.1 MHz

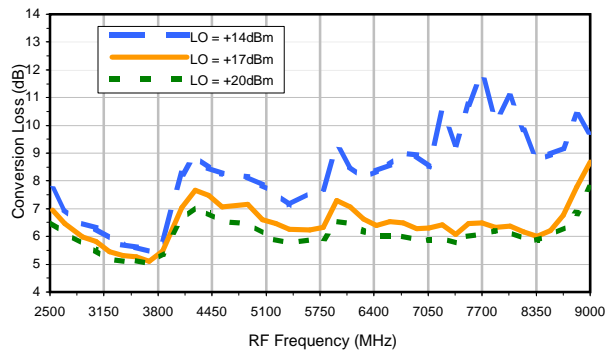

Conversion Loss vs. LO @ RF=5400 MHz

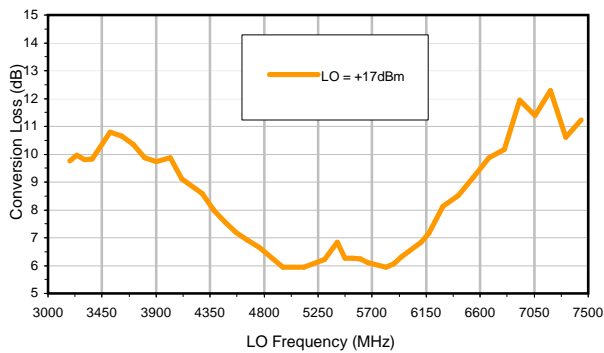

Conversion Loss vs. IF @ RF=5400 MHz

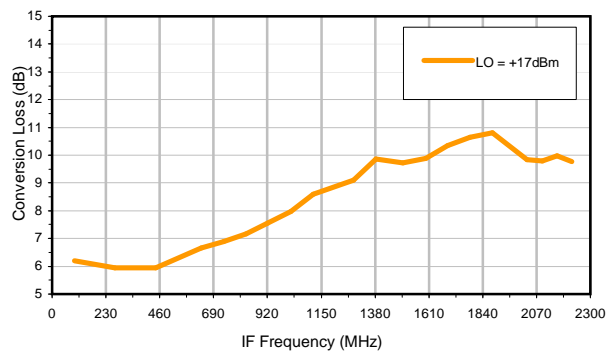

Conversion Loss vs. IF @ RF=2800 MHz

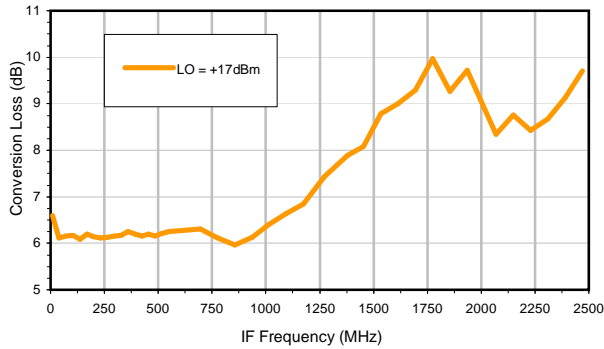

Conversion Loss vs. IF @ RF=8000 MHz

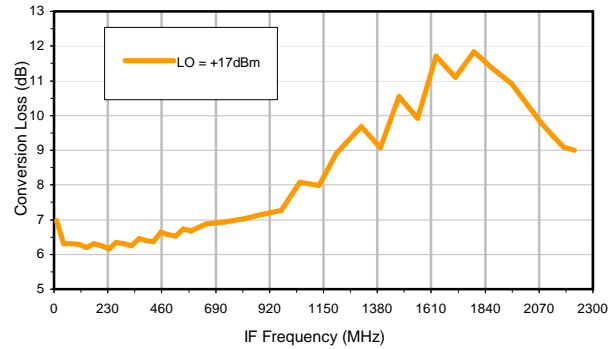

IP3 Input

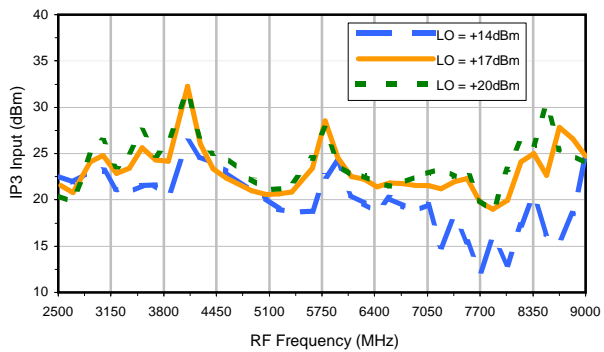

Compression @RF IN=+14 dBm

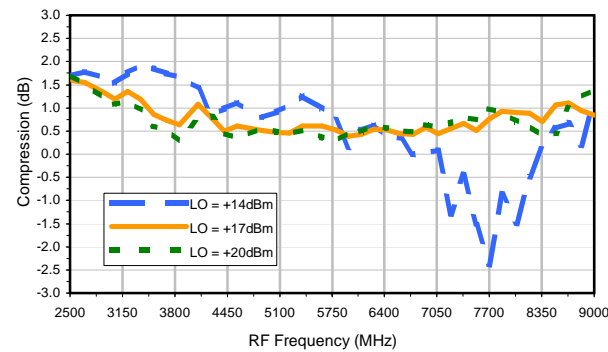

Typical Performance Curves

LO-RF Isolation

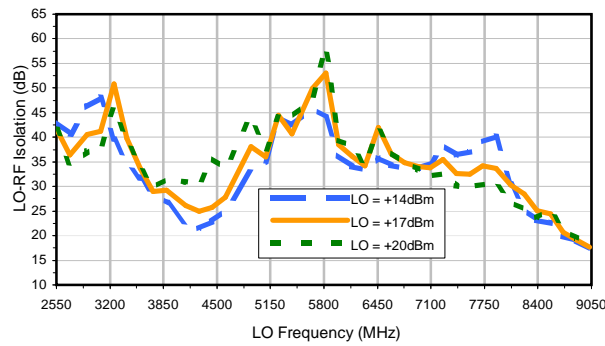

LO-IF Isolation

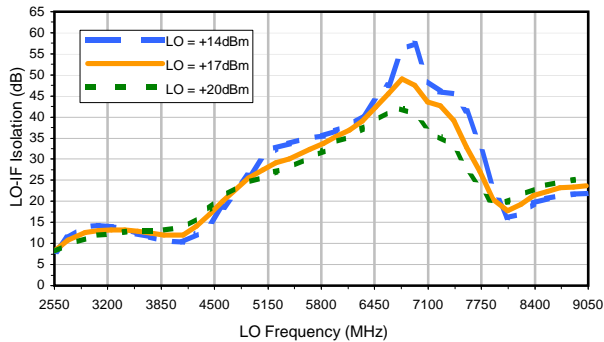

RF-IF Isolation

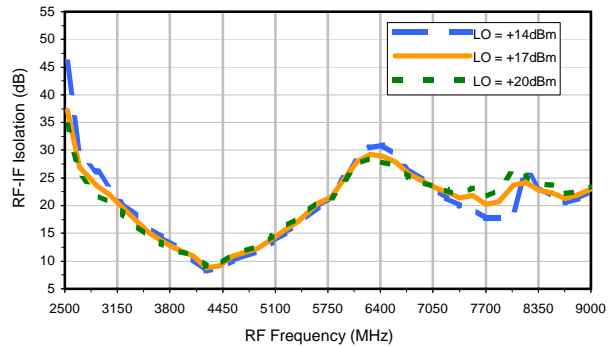

RF VSWR

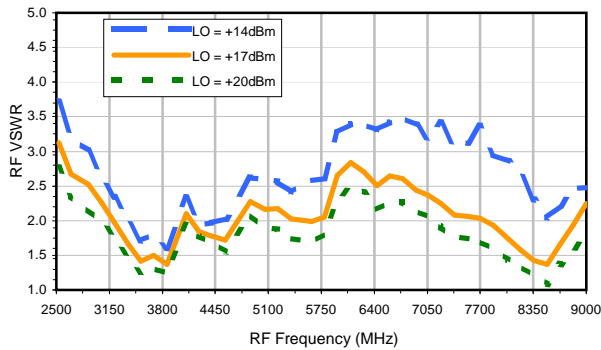

LO VSWR

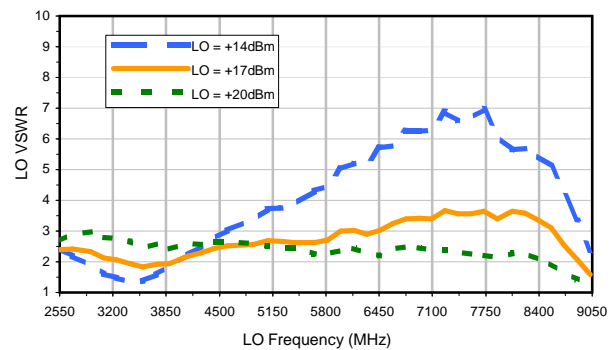

IF VSWR

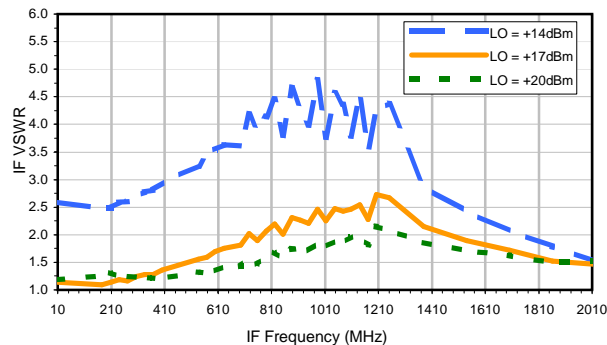

Harmonics Tables

RF HARMONICS ORDER

	(-dBm)	(-dBc)										
0	-	-	7	27	14	45	---	---	---	---	---	---
1	-	12	+0	35	31	50	54	---	---	---	---	---
2	65	64	76	50	60	60	54	58	---	---	---	---
3	>90	76	65	75	62	73	69	76	79	---	---	---
4	>90	>83	>83	>83	>83	>83	>83	>83	>83	>83	---	---
5	---	---	>83	>83	>83	>83	>83	>83	>83	>83	>83	---
6	---	---	---	82	>83	>83	>83	>83	>83	>83	>83	>83
7	---	---	---	---	>83	>83	>83	>83	>83	>83	>83	>83
8	---	---	---	---	---	>83	>83	>83	>83	>83	>83	>83
9	---	---	---	---	---	---	>83	>83	>83	>83	>83	>83
10	---	---	---	---	---	---	---	>83	>83	>83	>83	>83
	RF CAL	0	1	2	3	4	5	6	7	8	9	10

Test conditions: RF IN: 5400 MHz; -1.00 dBm.
 LO IN: 5430 MHz; +17.00 dBm
 IF OUT: 30 MHz; -7.4 dBm

RF HARMONICS ORDER

	(-dBm)	(-dBc)										
0	-	-	16	39	26	47	---	---	---	---	---	---
1	-	12	+0	37	31	52	62	---	---	---	---	---
2	46	52	64	44	53	51	48	55	---	---	---	---
3	63	55	45	57	41	56	55	61	70	---	---	---
4	76	65	72	66	70	58	69	64	67	64	---	---
5	---	---	88	82	73	78	60	76	65	73	81	---
6	---	---	---	>92	87	83	81	76	84	76	86	79
7	---	---	---	---	>92	>92	84	86	77	90	78	>92
8	---	---	---	---	---	>92	>92	>92	>92	81	>92	85
9	---	---	---	---	---	---	>92	>92	>92	>92	88	>92
10	---	---	---	---	---	---	---	>92	>92	>92	>92	>92
	RF CAL	0	1	2	3	4	5	6	7	8	9	10

LO HARMONICS ORDER

Test conditions: RF IN: 5400 MHz; 9.00 dBm.
 LO IN: 5430 MHz; +17.00 dBm
 IF OUT: 30 MHz; 2.37 dBm

- Notes: 1. All Harmonics are in (dBc) relative to IF OUTPUT.
 2. + entry denotes harmonics are in (dBc) above IF OUTPUT.
 3. RF Cal represent the Harmonics level of the RF input signal to the mixer.

DZ885-2

Outline Dimensions

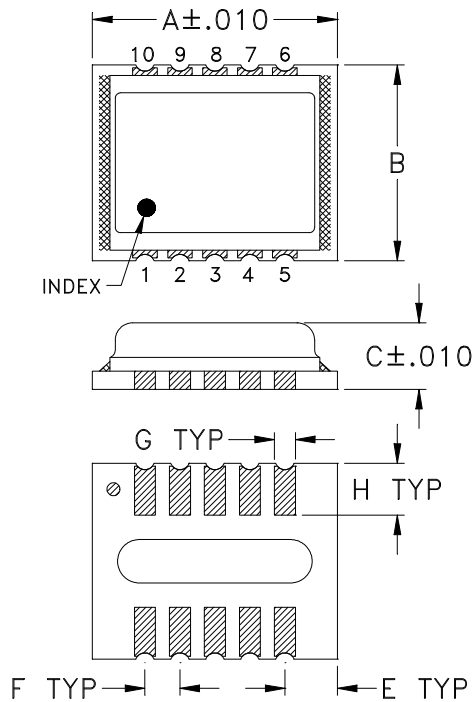

PCB Land Pattern

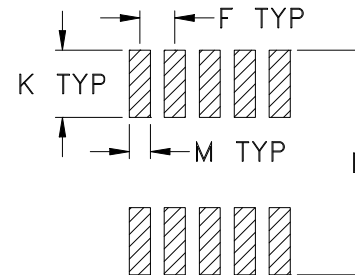

Suggested Layout,
Tolerance to be within $\pm .002$

CASE#	A	B	C	D	E	F	G	H	J	K	L	M	WT. GRAMS
DZ885-2	.350 (8.89)	.280 (7.11)	.095 (2.41)	-- --	.075 (1.91)	.050 (1.27)	.030 (0.76)	.074 (1.88)	-- --	.096 (2.44)	.321 (8.15)	.030 (0.76)	0.21

Dimensions are in inches (mm). Tolerances: 2Pl. $\pm .01$; 3Pl. $\pm .005$

Notes:

- Case material: Plastic encapsulation on Ceramic base, mounted on PCB carrier board.
- Termination finish:
For RoHS Case Styles: 3-5 μ inch (.08-.13 microns) Gold over 120-240 μ inch (3.05-6.10 microns) Nickel plate.
All models, (+) suffix.

Mini-Circuits

INTERNET <http://www.minicircuits.com>

P.O. Box 350166, Brooklyn, New York 11235-0003 (718) 934-4500 Fax (718) 332-4661

Distribution Centers NORTH AMERICA 800-654-7949 • 417-335-5935 • Fax 417-335-5945 • EUROPE 44-1252-832600 • Fax 44-1252-837010

Mini-Circuits ISO 9001 & ISO 14001 Certified

Tape & Reel Packaging TR-F34



Tape Width, mm	Device Cavity Pitch, mm	Reel Size, inches	Devices per Reel see note	
16	12	7	Small quantity standard (see note)	20
				50
				100
				200
		13	Standard	500
				1000

Note: Availability of small reel quantity varies by model.
Refer to pricing and availability on individual model dashboard.

Mini-Circuits carrier tape materials provide protection from ESD (Electro-Static Discharge) during handling and transportation. Tapes are static dissipative and comply with industry standards EIA-481/EIA-541.

Go to: www.minicircuits.com/pages/pdfs/tape.pdf



INTERNET <http://www.minicircuits.com>

P.O. Box 350166, Brooklyn, New York 11235-0003 (718) 934-4500 Fax (718) 332-4661

Distribution Centers NORTH AMERICA 800-654-7949 • 417-335-5935 • Fax 417-335-5945 • EUROPE 44-1252-832600 • Fax 44-1252-837010

Mini-Circuits ISO 9001 & ISO 14001 Certified

THIRD ANGLE PROJECTION

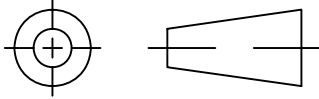

REVISIONS

REV	ECN No.	DESCRIPTION	DATE	DR	AUTH
OR	M119455	NEW RELEASE	09/08/08	AV	DJ

SUGGESTED MOUNTING CONFIGURATION FOR
 DZ885-2/DZ1383-2 CASE STYLES
 "10MX01" PIN CODE

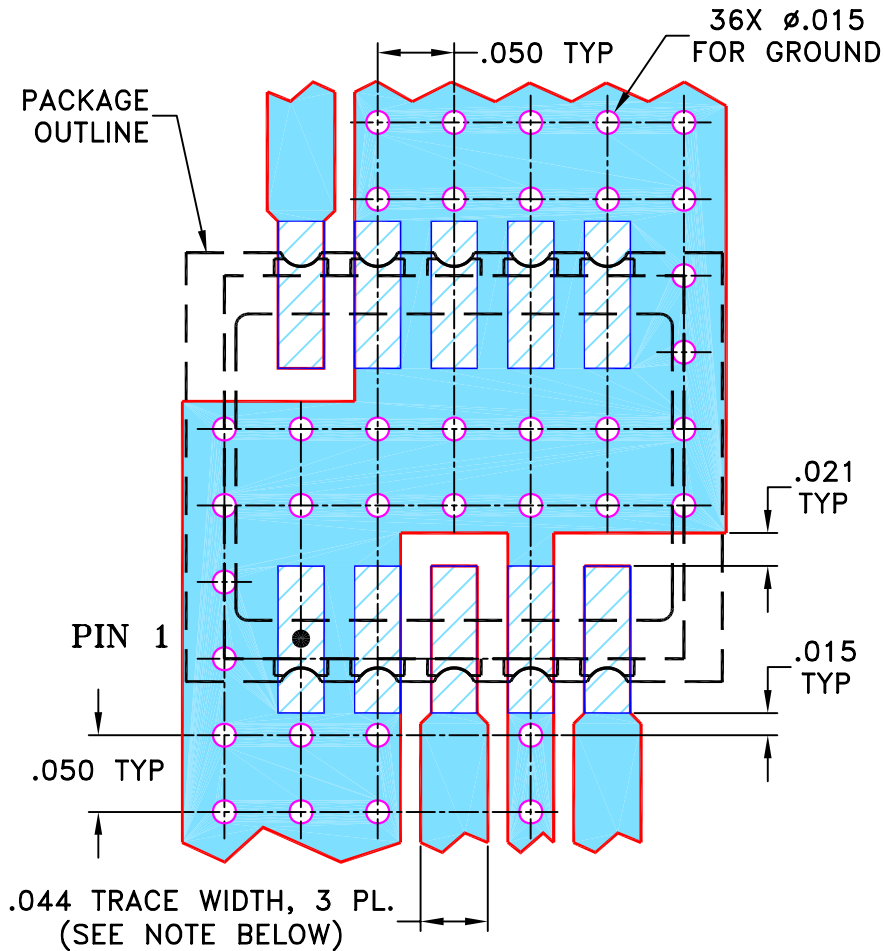

- NOTES: 1. TRACE WIDTH IS SHOWN FOR ROGERS R04350B WITH DIELECTRIC THICKNESS .020" ± .0015"; COPPER: 1/2 OZ. EACH SIDE. FOR OTHER MATERIALS TRACE WIDTH MAY NEED TO BE MODIFIED.
 2. BOTTOM SIDE OF THE PCB IS CONTINUOUS GROUND PLANE.



DENOTES PCB COPPER LAYOUT WITH SMOBC (SOLDER MASK OVER BARE COPPER)



DENOTES COPPER LAND PATTERN FREE OF SOLDER MASK

UNLESS OTHERWISE SPECIFIED	INITIALS	DATE
DIMENSIONS ARE IN INCHES	AV	09/05/08
TOLERANCES ON:	MMG	09/08/08
2 PL DECIMALS ±	DJ	09/08/08
3 PL DECIMALS ± .005		
ANGLES ±		
FRACTIONS ±		



Mini-Circuits®

13 Neptune Avenue
 Brooklyn NY 11235

PL, 10MX01, DZ885-2/DZ1383-2, TB-493

Mini-Circuits®
 THIS DOCUMENT AND ITS CONTENTS ARE THE PROPERTY OF MINI-CIRCUITS. EXCEPT FOR USE EXPRESSLY GRANTED, IN WRITING, TO ITS VENDORS, VENDEE AND THE UNITED STATES GOVERNMENT, MINI-CIRCUITS RESERVES ALL PROPRIETARY DESIGN, USE, MANUFACTURING AND REPRODUCTION RIGHTS THERETO. THESE CONTENTS SHALL NOT BE USED, DUPLICATED OR DISCLOSED TO ANY OUTSIDE PARTY, IN WHOLE OR IN PART, WITHOUT WRITTEN PERMISSION OF MINI-CIRCUITS.

SIZE A	CODE IDENT 15542	DRAWING NO: 98-PL-288	REV: OR
FILE: 98PL288	SCALE: 8:1	SHEET: 1 OF 1	

Evaluation Board and Circuit

For Pin Connections refer to Data Sheet of the DUT

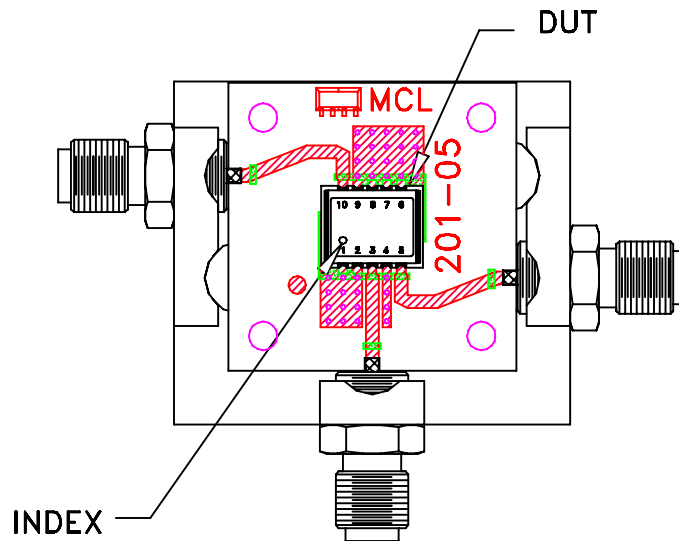

TB-493+

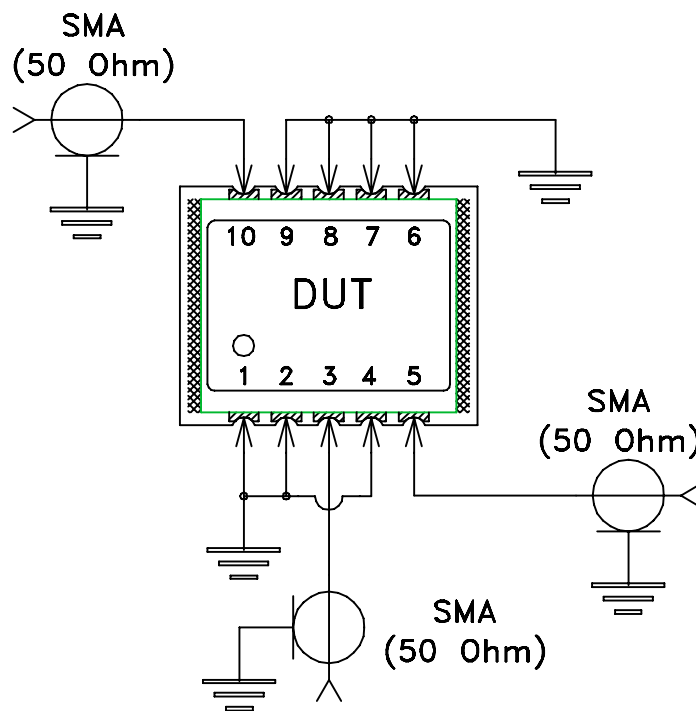

Schematic Diagram

Notes:

1. 50 Ohm SMA Female connectors.
2. PCB Material: R04350 or equivalent,
Dielectric Constant=3.5, Thickness=.020 inch.

 Mini-Circuits®



All Mini-Circuits products are manufactured under exacting quality assurance and control standards, and are capable of meeting published specifications after being subjected to any or all of the following physical and environmental test.

Specification	Test/Inspection Condition	Reference/Spec
Operating Temperature	-40° to 85° C Case Temperature	Individual Model Data Sheet
Storage Temperature	-40° to 85° C Ambient Environment	Individual Model Data Sheet
Autoclave	15 psig, 100% RH, 121°C, 96 hours	JESD22-A102-C, Condition C
Thermal Shock	-55° to 100°C, 100 cycles	MIL-STD-202, Method 107, Condition A-3, except +100°C
Solder Reflow Heat	Sn-Pb Eutectic Process: 225°C peak Pb-Free Process: 250°C peak	J-STD-020, Table 4-1, 4-2 and 5-2; Figure 5-1
Solderability	10X Magnification	J-STD-002, Para 4.2.5, Test S, 95% Coverage
Vibration (High Frequency)	20g peak, 10-2000 Hz, 12 times in each of three perpendicular directions (total 36)	MIL-STD-202, Method 204, Condition D
Mechanical Shock	50g, 11 ms, 1/2-sine, 18 shocks: 3 each direction, each of 3 axes	MIL-STD-202, Method 213, Condition A
Marking Resistance to Solvents	Isopropyl alcohol + mineral spirits at 25°C; terpene defluxer at 25°C; distilled water + proylene glycol monomethyl ether + monoethanolamine at 63°C to 70°C	MIL-STD-202, Method 215