

Surface Mount

Dual Matched MMIC Amplifier

MGVA-82+

50Ω

DC to 5.2 GHz

The Big Deal

- Gain, 14.1 dB typ. at 2 GHz
- Dual matched amplifier for push-pull & balanced amplifiers
- High dynamic range

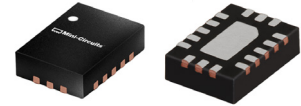

CASE STYLE: JV2579

Product Overview

MGVA-82+ (RoHS compliant) is an advanced wideband amplifier fabricated using InGaP HBT technology and offers high dynamic range over a broad frequency range. In addition, the MGVA-82+ has good input and output return loss over a broad frequency range without the need for external matching components. Lead finish is Matte-Tin and is enclosed in a 3.5 x 2.5 mm, 16-lead MCLP package for good thermal performance.

Key Features

Feature	Advantages
Broadband	Covers many communication bands including cellular, cable TV, PCS, SATCOM, WiMAX, and more.
Excellent Gain Flatness: ±0.6 dB over 0.05-2GHz	Requires no gain compensation in most wideband applications.
Matched pair for use in high IP3 and IP2 amplifiers. Gain match: ± 0.2 dB typ. Phase match: ± 3° typ. to 3 GHz	Enables it to be used in push-pull amplifiers resulting in outstanding IP2.
High IP3, up to 41 dBm	Ideal for suppressing unwanted intermodulation in the presence of multiple carriers, now common in many communication systems.
High P1dB: Up to 17.6 dBm	High P1dB enables the amplifier to operate in linear region in the presence of strong interfering signals.
Medium Noise Figure: 6.7-7.7 dB typ.	Together with High OIP3/P1dB, results in high dynamic range



Surface Mount

Dual Matched MMIC Amplifier

DC - 5.2GHz

Product Features

- Two matched amplifiers in one package
- High IP3, +36 dBm at 2 GHz
- High IP2, +44 dBm at 2 GHz in push-pull configuration
- Gain, 14.1 dB typ at 2 GHz
- Excellent Gain flatness, ±0.6 dB (0.05-2 GHz)
- P1dB, +20 dBm typ at 2 GHz



Generic photo used for illustration purposes only

MGVA-82+

CASE STYLE: JV2579

Typical Applications

- SATCOM
- CATV
- FTTH
- Optical networks
- Base station infrastructure
- Balanced amplifiers

+RoHS Compliant
The +Suffix identifies RoHS Compliance. See our web site for RoHS Compliance methodologies and qualifications

General Description

MGVA-82+ (RoHS compliant) is an advanced wideband amplifier fabricated using InGaP HBT technology and offers high dynamic range over a broad frequency range. In addition, the MGVA-82+ has good input and output return loss over a broad frequency range without the need for external matching components. Lead finish is Matte-Tin and is enclosed in a 3.5 x 2.5 mm, 16-lead MCLP package for good thermal performance.

simplified schematic (each of A1, A2) and pad description

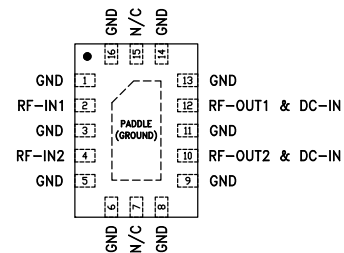
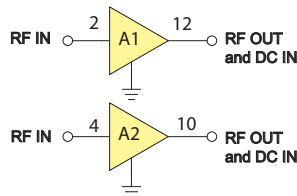

Function	Pad Number	Description
RF-IN1	2	RF input pin. This pin requires the use of an external DC blocking capacitor chosen for the frequency of operation. (see Characterization Test Circuit, Fig 1.)
RF-OUT1 & DC-IN	12	RF output and bias pin. DC voltage is present on this pin; therefore a DC blocking capacitor is necessary for proper operation. An RF choke is needed to feed DC bias without loss of RF signal due to the bias connection, as shown in "Characterization Test Circuit", Fig 1
RF-IN2	4	RF input pin. This pin requires the use of an external DC blocking capacitor chosen for the frequency of operation. (see Characterization Test Circuit, Fig 1.)
RF-OUT2 & DC-IN	10	RF output and bias pin. DC voltage is present on this pin; therefore a DC blocking capacitor is necessary for proper operation. An RF choke is needed to feed DC bias without loss of RF signal due to the bias connection, as shown in "Characterization Test Circuit", Fig 1
GND	1,3,5,6,8,9,11,13,14,16 & paddle	Connections to ground. Use via holes as shown in "Suggested Layout for PCB Design" to reduce ground path inductance for best performance.
N/C	7,15	No Connection

* Enhancement mode pseudomorphic High Electron Mobility Transistor.



Electrical Specifications¹ at 25°C, Zo=50Ω and Device Voltage 5V, unless noted

(Specifications (other than Matching or where defined as push-pull) are for each of the two matched amplifiers in the package)

Parameter	Condition (MHz)	Min.	Typ.	Max.	Units
Frequency Range		DC		5.2	GHz
Gain	50	13.8	15.3	16.8	dB
	1000	—	14.9	—	
	2000	12.2	14.1	15.5	
	3000	—	13.2	—	
	4000	9.8	12.1	13.3	
	5200	—	9.9	—	
Gain Flatness	50 - 2000	—	±0.6	—	dB
Input Return Loss	50		32.4		dB
	1000		23.5		
	2000		17.7		
	3000		15.4		
	4000		13.0		
	5200		9.4		
Output Return Loss	50		16.2		dB
	1000		14.7		
	2000		11.7		
	3000		10.5		
	4000		9.1		
	5200		6.9		
Output power @ 1 dB Compression	50		20.2		dBm
	1000		20.3		
	2000		20.2		
	3000		19.8		
	4000		19.5		
	5200		18.3		
Output IP3	50	—	41	—	dBm
	1000	—	38	—	
	2000	33	36	—	
	3000	—	35	—	
	4000	—	33	—	
	5200	—	32	—	
Output IP2	50	—	55	—	dBm
	1000	—	55	—	
	2000	40	44	—	
	3000	—	41	—	
	4000	—	38	—	
	5200	—	37	—	
Noise Figure	50		6.7		dB
	1000		6.8		
	2000		7.0		
	3000		7.1		
	4000		7.3		
	5200		7.7		
Matching between A1, A2	Amplitude Unbalance	50		0.1	dB
		1000		0.1	
		2000		0.1	
		3000		0.2	
		4000		0.2	
		5200		0.3	
	Phase Unbalance	50		0.1	deg
		1000		1.1	
		2000		1.9	
		3000		3.4	
		4000		6.7	
		5200		9.4	
Device operating voltage		4.8	5.0	5.2	V
Device operating current		—	100	120	mA
Device current variation vs. temperature ⁴			70.5		μA/°C
Device current variation vs voltage ⁵			0.038		mA/mV
Thermal Resistance, junction-to-ground lead			39.4		°C/W

(1) Measured on Mini-Circuits Test Board TB-1002+, see characterization circuit, Fig 1.

(2) $\theta_{jc} = (\text{Junction Temperature} - \text{Ground Pad Temperature}) / (\text{Voltage} \times \text{sum of current in A1 \& A2})$

Absolute Maximum Ratings for each Amplifier⁽³⁾

Parameter	Ratings
Operating Temperature ⁴	-40°C to 85°C
Storage Temperature	-65°C to 150°C
Operating Current at 5V	160 mA
Power Dissipation	0.84 W
Input Power (CW)	20 dBm
DC Voltage (pads 10, 12)	5.8V

⁽³⁾ Permanent damage may occur if any of these limits are exceeded. These ratings are not intended for continuous normal operation.
⁽⁴⁾ Defined with reference to ground pad temperature.

Characterization Test Circuit

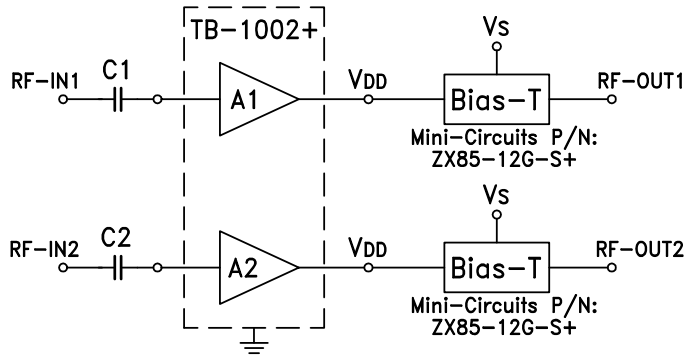

Fig 1. Block Diagram of Test Circuit used for characterization. (DUT tested in Mini-Circuits Test board TB-1002+). Gain, Return loss, Output Power at 1dB compression (P1 dB), output IP3 (OIP3) and noise figure measured using Agilent’s N5242A PNA-X micro-wave network analyzer.

Conditions:

1. Gain and Return loss: Pin= -25dBm
 2. Output IP3 (OIP3) & Output IP2 (OIP2): Two tones, spaced 1MHz apart, 0 dBm/tone at output.
- Note: C1&C2 are PNA built-in DC Blocks.

Product Marking



Marking may contain other features or characters for internal lot control

Additional Detailed Technical Information	
<i>additional information is available on our dash board. To access this information click here</i>	
Performance Data	Data Table
	Swept Graphs
	S-Parameter (S4P Files) Data Set (.zip file)
Case Style	JV2579 <i>Plastic package, exposed paddle lead finish: Matte-Tin plate</i>
Tape & Reel Standard quantities available on reel	F104 <i>7" reels with 2K devices</i>
Suggested Layout for PCB Design	PL-582
Evaluation Board	TB-1002+
Environmental Ratings	ENV08T2

ESD Rating

Human Body Model (HBM): Class 1C (1000 to <2000V) in accordance with ANSI/ESD STM 5.1 - 2001**

** Tested as a single ended amplifier in SOT-89 package.

MSL Test Flow Chart

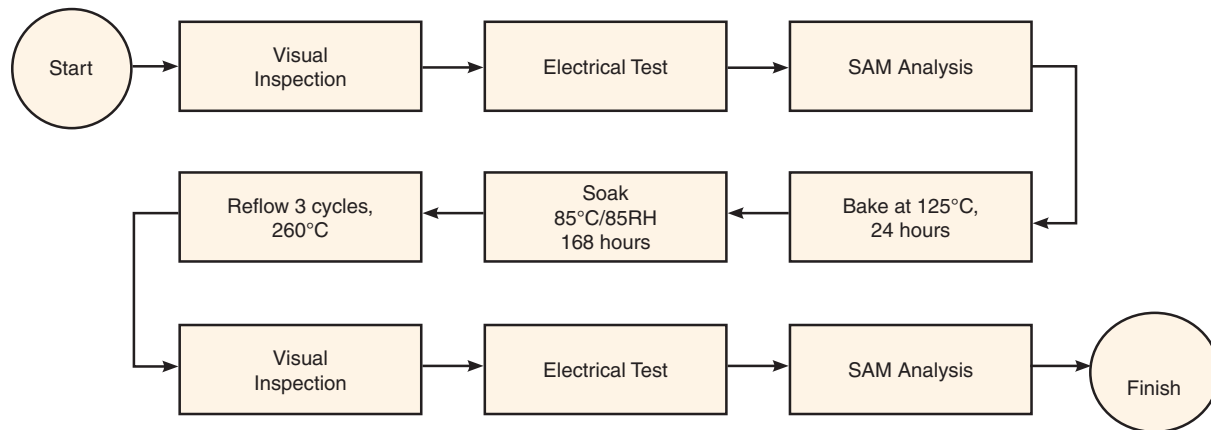

Additional Notes

- A. Performance and quality attributes and conditions not expressly stated in this specification document are intended to be excluded and do not form a part of this specification document.
- B. Electrical specifications and performance data contained in this specification document are based on Mini-Circuit's applicable established test performance criteria and measurement instructions.
- C. The parts covered by this specification document are subject to Mini-Circuits standard limited warranty and terms and conditions (collectively, "Standard Terms"); Purchasers of this part are entitled to the rights and benefits contained therein. For a full statement of the Standard Terms and the exclusive rights and remedies thereunder, please visit Mini-Circuits' website at www.minicircuits.com/MCLStore/terms.jsp

Typical Performance Data

NOTE: Use PDF Bookmarks to view DATA at required conditions

Definitions:

- Input Return Loss = -S11 (dB)
- Gain(Power Gain) = S21 (dB)
- Reverse Isolation = -S12 (dB)
- Output Return Loss = -S22 (dB)

TEST CONDITIONS: Vd = 5.00V, Id = 101.96mA @ Temperature = +25°C

FREQ	Gain	Isolation	Input Return Loss	Output Return Loss	Stability		IP-3 Output	1dB Comp. Output	Noise Figure
					K	Measure			
(MHz)	(dB)	(dB)	(dB)	(dB)	K	Measure	(dBm)	(dBm)	(dB)
20	15.33	24.16	31.60	16.22	1.53	0.84	39.00	19.65	6.75
50	15.33	24.16	31.63	16.22	1.53	0.84	40.06	20.28	6.59
80	15.32	24.18	31.48	16.22	1.54	0.84	40.13	20.21	6.56
100	15.31	24.18	31.38	16.23	1.54	0.84	40.95	20.05	6.54
200	15.27	24.19	30.90	16.17	1.54	0.85	41.17	20.25	6.52
300	15.24	24.18	30.67	16.12	1.55	0.85	40.53	20.30	6.58
400	15.20	24.17	30.35	16.07	1.55	0.85	40.25	20.27	6.56
500	15.16	24.15	29.74	15.96	1.55	0.85	40.21	20.41	6.51
600	15.12	24.12	28.97	15.84	1.55	0.85	41.35	20.30	6.53
700	15.07	24.08	27.94	15.65	1.55	0.85	40.39	20.27	6.56
800	15.02	24.05	26.99	15.43	1.54	0.85	40.42	20.24	6.58
900	14.96	24.00	25.89	15.16	1.54	0.85	40.20	20.15	6.65
1000	14.90	23.95	24.79	14.89	1.53	0.85	40.49	20.35	6.65
1200	14.77	23.85	22.86	14.24	1.52	0.85	38.99	20.26	6.75
1400	14.61	23.73	21.18	13.57	1.51	0.85	38.08	20.19	6.80
1600	14.45	23.60	19.73	12.95	1.50	0.85	38.07	20.24	6.83
1800	14.27	23.48	18.53	12.35	1.49	0.85	37.80	20.16	6.84
2000	14.09	23.33	17.48	11.81	1.47	0.86	37.87	20.31	6.83
2200	13.91	23.20	16.63	11.36	1.45	0.86	37.48	20.37	6.84
2400	13.74	23.04	15.92	11.01	1.43	0.86	36.89	20.12	6.82
2600	13.55	22.89	15.41	10.75	1.43	0.86	36.86	20.04	6.85
2800	13.38	22.71	14.94	10.54	1.41	0.86	36.12	19.91	6.90
3000	13.20	22.56	14.56	10.43	1.40	0.86	36.32	20.00	6.92
3200	13.01	22.41	14.28	10.29	1.40	0.86	35.40	20.13	6.97
3400	12.81	22.25	13.93	10.15	1.40	0.86	35.11	19.93	6.98
3600	12.60	22.12	13.60	10.03	1.40	0.87	34.91	19.87	6.99
3800	12.38	22.00	13.24	9.88	1.40	0.87	34.32	19.56	7.10
4000	12.12	21.90	12.81	9.61	1.41	0.87	34.61	19.73	7.07
4200	11.85	21.82	12.38	9.29	1.42	0.86	34.25	19.65	7.08
4400	11.54	21.78	11.85	8.95	1.43	0.86	34.09	19.39	7.18
4600	11.25	21.73	11.41	8.64	1.44	0.86	33.71	19.21	7.26
4800	10.93	21.71	10.98	8.33	1.46	0.86	33.63	18.98	7.25
5000	10.61	21.67	10.61	8.05	1.47	0.86	32.60	18.44	7.37
5200	10.26	21.66	10.20	7.80	1.49	0.86	33.13	18.50	7.42
5400	9.93	21.65	9.85	7.60	1.51	0.87	33.44	18.48	7.48
5600	9.57	21.61	9.57	7.46	1.53	0.87	32.75	18.36	7.56
5800	9.27	21.61	9.24	7.28	1.55	0.87	32.52	18.19	7.62
6000	8.93	21.62	9.07	7.30	1.60	0.88	32.12	17.93	7.68
6200	8.63	21.62	8.82	7.15	1.63	0.88	32.15	17.77	7.73
6400	8.28	21.61	8.57	7.03	1.66	0.89	32.16	17.74	7.81
6600	7.93	21.61	8.37	7.02	1.71	0.89	31.94	17.64	7.90
6800	7.58	21.67	8.10	6.83	1.75	0.89	31.61	17.40	8.02
7000	7.14	21.79	7.89	6.72	1.83	0.90	31.60	17.14	8.16

Typical Performance Data

Definitions:

Input Return Loss = -S11 (dB)

Gain(Power Gain) = S21 (dB)

Reverse Isolation = -S12 (dB)

Output Return Loss = -S22 (dB)

TEST CONDITIONS: Vd = 4.75V, Id = 92.82mA @ Temperature = +25°C

FREQ	Gain	Isolation	Input Return Loss	Output Return Loss	Stability		IP-3 Output	1dB Comp. Output	Noise Figure
					K	Measure			
(MHz)	(dB)	(dB)	(dB)	(dB)	K	Measure	(dBm)	(dBm)	(dB)
20	15.29	24.10	30.36	16.01	1.53	0.84	49.65	18.86	6.63
50	15.28	24.10	30.29	16.01	1.53	0.84	39.11	19.45	6.45
80	15.27	24.11	30.31	16.02	1.53	0.84	38.86	19.39	6.44
100	15.26	24.12	30.14	16.03	1.53	0.84	39.58	19.25	6.42
200	15.23	24.13	29.79	15.97	1.54	0.84	39.07	19.42	6.42
300	15.19	24.12	29.68	15.93	1.54	0.84	39.53	19.47	6.40
400	15.15	24.11	29.51	15.88	1.55	0.85	38.67	19.44	6.44
500	15.12	24.08	29.02	15.78	1.54	0.85	38.57	19.56	6.41
600	15.07	24.06	28.39	15.66	1.54	0.85	39.20	19.45	6.43
700	15.03	24.01	27.51	15.47	1.54	0.85	38.96	19.43	6.51
800	14.98	23.97	26.62	15.26	1.54	0.85	38.78	19.40	6.48
900	14.92	23.93	25.65	14.99	1.53	0.85	38.71	19.32	6.57
1000	14.86	23.88	24.65	14.72	1.53	0.85	38.50	19.48	6.55
1200	14.72	23.77	22.75	14.09	1.52	0.85	37.71	19.42	6.60
1400	14.56	23.64	21.10	13.45	1.51	0.85	37.41	19.36	6.70
1600	14.40	23.52	19.68	12.82	1.49	0.85	37.15	19.40	6.70
1800	14.22	23.39	18.46	12.24	1.48	0.85	37.32	19.33	6.73
2000	14.04	23.24	17.43	11.71	1.46	0.85	37.45	19.44	6.72
2200	13.85	23.09	16.57	11.26	1.44	0.85	36.80	19.50	6.74
2400	13.69	22.94	15.85	10.92	1.42	0.86	35.83	19.32	6.72
2600	13.49	22.79	15.36	10.66	1.42	0.86	35.90	19.24	6.74
2800	13.32	22.61	14.87	10.46	1.40	0.86	35.03	19.15	6.78
3000	13.14	22.45	14.51	10.35	1.39	0.86	35.47	19.21	6.80
3200	12.94	22.29	14.24	10.22	1.39	0.86	34.84	19.33	6.84
3400	12.74	22.14	13.88	10.07	1.39	0.86	34.40	19.18	6.87
3600	12.54	22.01	13.58	9.96	1.39	0.86	34.21	19.14	6.89
3800	12.31	21.88	13.21	9.81	1.40	0.86	33.84	18.87	6.96
4000	12.05	21.79	12.80	9.55	1.40	0.86	33.86	19.02	6.96
4200	11.78	21.71	12.37	9.24	1.41	0.86	33.72	18.96	6.95
4400	11.46	21.66	11.85	8.90	1.42	0.86	33.53	18.74	7.05
4600	11.17	21.62	11.40	8.60	1.44	0.86	33.05	18.58	7.15
4800	10.86	21.60	10.98	8.29	1.45	0.86	33.04	18.37	7.14
5000	10.53	21.56	10.61	8.01	1.46	0.86	32.04	17.83	7.26
5200	10.18	21.55	10.19	7.76	1.48	0.86	32.49	17.93	7.32
5400	9.85	21.54	9.85	7.56	1.50	0.87	32.84	17.91	7.34
5600	9.49	21.51	9.57	7.42	1.53	0.87	32.35	17.84	7.40
5800	9.19	21.50	9.25	7.25	1.55	0.87	31.95	17.64	7.42
6000	8.85	21.52	9.07	7.28	1.60	0.88	31.49	17.42	7.55
6200	8.55	21.52	8.84	7.12	1.63	0.88	31.62	17.29	7.60
6400	8.20	21.51	8.57	7.01	1.66	0.89	31.81	17.28	7.65
6600	7.85	21.53	8.38	6.97	1.71	0.89	31.30	17.18	7.78
6800	7.50	21.59	8.12	6.83	1.75	0.89	31.16	16.96	7.86
7000	7.06	21.69	7.91	6.72	1.83	0.90	31.06	16.73	7.96

Typical Performance Data

Definitions:

Input Return Loss = -S11 (dB)

Gain(Power Gain) = S21 (dB)

Reverse Isolation = -S12 (dB)

Output Return Loss = -S22 (dB)

TEST CONDITIONS: Vd = 5.25V, Id = 111.34mA @ Temperature = +25°C

FREQ	Gain	Isolation	Input Return Loss	Output Return Loss	Stability		IP-3 Output	1dB Comp. Output	Noise Figure
					K	Measure			
(MHz)	(dB)	(dB)	(dB)	(dB)	K	Measure	(dBm)	(dBm)	(dB)
20	15.37	24.21	32.58	16.40	1.54	0.84	39.70	20.34	6.89
50	15.37	24.22	32.71	16.41	1.54	0.84	41.07	21.02	6.72
80	15.36	24.23	32.60	16.42	1.54	0.85	40.34	20.94	6.68
100	15.35	24.23	32.52	16.42	1.54	0.85	45.05	20.78	6.68
200	15.31	24.24	31.93	16.35	1.55	0.85	40.90	21.00	6.66
300	15.28	24.24	31.63	16.30	1.55	0.85	42.84	21.04	6.69
400	15.23	24.23	31.13	16.25	1.55	0.85	41.67	21.01	6.66
500	15.20	24.20	30.40	16.14	1.55	0.85	41.56	21.17	6.62
600	15.15	24.18	29.42	16.00	1.55	0.85	42.94	21.03	6.67
700	15.11	24.14	28.25	15.81	1.55	0.85	41.96	21.01	6.74
800	15.06	24.10	27.14	15.58	1.55	0.85	41.06	20.98	6.70
900	15.00	24.06	26.04	15.30	1.54	0.85	40.24	20.87	6.78
1000	14.94	24.01	24.95	15.02	1.54	0.85	40.70	21.10	6.79
1200	14.81	23.91	22.92	14.36	1.53	0.85	39.55	21.01	6.83
1400	14.65	23.79	21.25	13.70	1.52	0.85	39.27	20.93	6.90
1600	14.50	23.67	19.77	13.05	1.50	0.86	38.88	20.98	6.96
1800	14.32	23.55	18.53	12.45	1.49	0.86	38.19	20.91	6.95
2000	14.14	23.41	17.51	11.89	1.47	0.86	38.43	21.09	6.93
2200	13.96	23.27	16.64	11.44	1.46	0.86	38.18	21.15	6.98
2400	13.80	23.12	15.94	11.09	1.44	0.86	37.03	20.85	6.95
2600	13.61	22.98	15.44	10.82	1.43	0.86	36.84	20.77	6.99
2800	13.44	22.80	14.96	10.60	1.42	0.86	35.97	20.58	7.01
3000	13.26	22.65	14.58	10.49	1.41	0.86	36.57	20.70	7.03
3200	13.07	22.49	14.30	10.35	1.41	0.86	35.80	20.77	7.03
3400	12.87	22.33	13.94	10.20	1.40	0.87	35.57	20.56	7.11
3600	12.67	22.21	13.60	10.08	1.40	0.87	35.15	20.49	7.14
3800	12.44	22.08	13.23	9.93	1.41	0.87	34.78	20.15	7.20
4000	12.19	21.99	12.80	9.66	1.42	0.87	34.60	20.34	7.21
4200	11.92	21.91	12.37	9.33	1.42	0.87	34.65	20.24	7.23
4400	11.61	21.86	11.85	8.98	1.44	0.87	34.22	19.96	7.32
4600	11.32	21.81	11.38	8.67	1.45	0.86	33.96	19.78	7.41
4800	11.01	21.79	10.97	8.36	1.46	0.86	33.93	19.54	7.43
5000	10.68	21.75	10.59	8.07	1.47	0.86	33.05	18.96	7.50
5200	10.34	21.74	10.17	7.81	1.49	0.87	33.28	19.05	7.58
5400	10.00	21.73	9.83	7.61	1.51	0.87	33.56	19.03	7.61
5600	9.64	21.69	9.55	7.46	1.53	0.87	33.24	18.91	7.70
5800	9.34	21.68	9.22	7.29	1.56	0.88	32.64	18.71	7.74
6000	9.01	21.70	9.05	7.31	1.60	0.88	32.35	18.47	7.80
6200	8.71	21.69	8.81	7.14	1.63	0.88	32.36	18.29	7.89
6400	8.36	21.68	8.54	7.03	1.66	0.89	32.55	18.23	7.94
6600	8.01	21.68	8.35	7.02	1.71	0.89	32.18	18.10	8.09
6800	7.66	21.74	8.09	6.83	1.75	0.89	31.86	17.84	8.16
7000	7.21	21.86	7.88	6.72	1.83	0.90	31.89	17.58	8.30

Typical Performance Data

Definitions:

Input Return Loss = -S11 (dB)

Gain(Power Gain) = S21 (dB)

Reverse Isolation = -S12 (dB)

Output Return Loss = -S22 (dB)

TEST CONDITIONS: Vd = 5.00V, Id = 96.78mA @ Temperature = -45°C

FREQ	Gain	Isolation	Input Return Loss	Output Return Loss	Stability		IP-3 Output	1dB Comp. Output	Noise Figure
					K	Measure			
(MHz)	(dB)	(dB)	(dB)	(dB)	K	Measure	(dBm)	(dBm)	(dB)
20	15.25	24.04	28.39	15.57	1.52	0.84	40.84	19.34	6.09
50	15.24	24.04	27.60	15.41	1.52	0.84	41.49	19.93	5.89
80	15.22	24.05	26.68	15.21	1.53	0.84	39.75	19.88	5.86
100	15.22	24.06	26.09	15.09	1.53	0.83	42.06	19.75	5.82
200	15.19	24.06	26.09	15.05	1.53	0.84	41.57	19.93	5.81
300	15.18	24.03	28.46	15.66	1.53	0.84	41.26	19.98	5.84
400	15.15	24.01	28.60	15.87	1.53	0.84	40.89	19.95	5.80
500	15.13	23.98	29.02	15.76	1.53	0.84	41.03	20.07	5.78
600	15.08	23.95	28.54	15.52	1.53	0.84	40.82	19.97	5.81
700	15.04	23.91	27.41	15.24	1.52	0.84	41.10	19.97	5.85
800	14.99	23.87	26.89	15.08	1.52	0.84	40.36	19.93	5.83
900	14.94	23.82	25.69	14.81	1.52	0.84	40.12	19.87	5.93
1000	14.88	23.76	24.60	14.61	1.51	0.84	40.11	20.03	5.93
1200	14.77	23.63	23.02	14.46	1.50	0.85	39.40	19.98	5.97
1400	14.61	23.52	21.15	13.65	1.49	0.85	39.08	19.91	6.02
1600	14.45	23.40	19.56	12.98	1.47	0.85	38.31	19.95	6.06
1800	14.26	23.29	18.24	12.28	1.46	0.85	38.11	19.87	6.07
2000	14.09	23.14	17.25	11.84	1.44	0.85	39.08	19.97	6.05
2200	13.91	23.01	16.48	11.25	1.42	0.85	38.57	20.02	6.05
2400	13.74	22.86	15.84	10.80	1.40	0.85	37.51	19.89	6.05
2600	13.54	22.73	15.57	10.35	1.39	0.85	37.07	19.78	6.05
2800	13.39	22.54	15.13	10.16	1.37	0.85	36.28	19.76	6.09
3000	13.24	22.36	15.02	10.05	1.37	0.85	36.78	19.78	6.08
3200	13.06	22.21	14.80	9.88	1.36	0.84	36.10	20.00	6.11
3400	12.86	22.05	14.58	9.60	1.35	0.84	35.74	19.87	6.17
3600	12.68	21.91	14.36	9.49	1.35	0.84	35.65	19.87	6.19
3800	12.48	21.78	13.81	9.53	1.36	0.85	35.20	19.64	6.28
4000	12.23	21.69	13.12	9.28	1.36	0.85	35.34	19.78	6.24
4200	11.95	21.63	12.52	9.01	1.37	0.85	35.16	19.71	6.27
4400	11.65	21.58	11.95	8.72	1.38	0.85	34.97	19.52	6.37
4600	11.39	21.51	11.41	8.59	1.39	0.86	34.51	19.44	6.45
4800	11.12	21.47	11.05	8.45	1.40	0.87	34.30	19.23	6.42
5000	10.84	21.40	10.83	8.15	1.41	0.86	33.07	18.78	6.53
5200	10.55	21.34	10.50	8.00	1.41	0.87	33.79	18.86	6.59
5400	10.30	21.26	10.20	7.95	1.43	0.87	34.10	18.77	6.60
5600	9.99	21.19	10.02	7.82	1.44	0.87	33.96	18.82	6.67
5800	9.76	21.14	9.64	7.65	1.45	0.87	33.63	18.71	6.69
6000	9.44	21.15	9.37	7.56	1.49	0.88	33.12	18.42	6.74
6200	9.15	21.13	8.96	7.36	1.50	0.88	32.87	18.27	6.84
6400	8.83	21.14	8.67	7.16	1.52	0.88	33.20	18.24	6.85
6600	8.44	21.18	8.20	6.99	1.55	0.88	32.99	18.25	6.99
6800	8.02	21.31	7.82	6.64	1.59	0.88	32.76	17.95	7.10
7000	7.55	21.47	7.49	6.41	1.64	0.88	32.60	17.68	7.25

Typical Performance Data

Definitions:

Input Return Loss = -S11 (dB)

Gain(Power Gain) = S21 (dB)

Reverse Isolation = -S12 (dB)

Output Return Loss = -S22 (dB)

TEST CONDITIONS: Vd = 4.75V, Id = 87.93mA @ Temperature = -45°C

FREQ	Gain	Isolation	Input Return Loss	Output Return Loss	Stability		IP-3 Output	1dB Comp. Output	Noise Figure
					K	Measure			
(MHz)	(dB)	(dB)	(dB)	(dB)	K	Measure	(dBm)	(dBm)	(dB)
20	15.20	23.97	27.49	15.36	1.52	0.83	40.57	18.53	5.97
50	15.18	23.97	26.75	15.21	1.52	0.83	39.85	19.05	5.76
80	15.17	23.99	25.94	15.01	1.52	0.83	39.34	19.01	5.74
100	15.16	23.99	25.38	14.89	1.52	0.83	39.92	18.90	5.71
200	15.13	23.99	25.37	14.86	1.53	0.83	39.02	19.04	5.71
300	15.13	23.96	27.56	15.45	1.53	0.84	38.92	19.09	5.65
400	15.10	23.94	27.77	15.65	1.53	0.84	39.18	19.07	5.72
500	15.07	23.91	28.17	15.55	1.53	0.84	38.26	19.14	5.69
600	15.03	23.88	27.83	15.32	1.52	0.84	39.60	19.08	5.71
700	14.99	23.84	26.79	15.05	1.52	0.84	39.57	19.07	5.77
800	14.94	23.79	26.50	14.90	1.52	0.84	39.62	19.06	5.75
900	14.88	23.74	25.35	14.63	1.51	0.84	38.47	19.00	5.83
1000	14.83	23.69	24.35	14.44	1.51	0.84	38.72	19.10	5.83
1200	14.71	23.55	22.91	14.29	1.49	0.85	37.79	19.09	5.88
1400	14.55	23.44	21.08	13.51	1.48	0.85	37.79	19.03	5.92
1600	14.39	23.31	19.49	12.85	1.46	0.85	37.50	19.06	5.98
1800	14.20	23.19	18.19	12.17	1.45	0.85	37.06	18.99	5.97
2000	14.03	23.04	17.18	11.73	1.43	0.85	37.24	19.02	5.95
2200	13.84	22.91	16.44	11.15	1.42	0.85	37.26	19.06	5.97
2400	13.67	22.76	15.78	10.71	1.40	0.85	36.09	19.03	5.93
2600	13.47	22.62	15.50	10.27	1.39	0.85	36.10	18.93	5.97
2800	13.32	22.43	15.08	10.08	1.37	0.85	35.22	18.94	6.00
3000	13.16	22.26	14.96	9.98	1.36	0.84	35.71	18.95	6.01
3200	12.98	22.10	14.76	9.81	1.35	0.84	35.08	19.13	5.99
3400	12.78	21.94	14.55	9.53	1.35	0.84	34.89	19.04	6.06
3600	12.59	21.80	14.35	9.43	1.35	0.84	34.65	19.06	6.10
3800	12.39	21.67	13.78	9.47	1.35	0.84	34.18	18.89	6.17
4000	12.14	21.58	13.11	9.22	1.36	0.85	34.17	18.99	6.19
4200	11.86	21.52	12.51	8.97	1.36	0.85	34.01	18.92	6.17
4400	11.56	21.47	11.95	8.68	1.37	0.85	33.80	18.77	6.25
4600	11.30	21.40	11.41	8.55	1.38	0.86	33.70	18.74	6.33
4800	11.03	21.36	11.05	8.42	1.39	0.87	33.52	18.55	6.31
5000	10.75	21.29	10.83	8.13	1.40	0.86	32.42	18.16	6.44
5200	10.45	21.23	10.51	7.97	1.41	0.86	32.93	18.22	6.47
5400	10.21	21.16	10.21	7.93	1.42	0.87	33.30	18.15	6.45
5600	9.89	21.08	10.02	7.81	1.44	0.87	33.06	18.23	6.54
5800	9.66	21.04	9.65	7.63	1.45	0.87	32.74	18.12	6.60
6000	9.34	21.05	9.37	7.55	1.48	0.88	32.29	17.86	6.65
6200	9.05	21.03	8.97	7.35	1.50	0.88	32.07	17.67	6.74
6400	8.72	21.04	8.67	7.16	1.52	0.88	32.49	17.65	6.78
6600	8.33	21.08	8.22	6.99	1.56	0.88	32.35	17.71	6.92
6800	7.92	21.22	7.83	6.64	1.59	0.88	32.08	17.39	6.97
7000	7.45	21.38	7.50	6.41	1.64	0.88	32.04	17.13	7.13

Typical Performance Data

Definitions:

Input Return Loss = -S11 (dB)

Gain(Power Gain) = S21 (dB)

Reverse Isolation = -S12 (dB)

Output Return Loss = -S22 (dB)

TEST CONDITIONS: Vd = 5.25V, Id = 105.78mA @ Temperature = -45°C

FREQ	Gain	Isolation	Input Return Loss	Output Return Loss	Stability		IP-3 Output	1dB Comp. Output	Noise Figure
					K	Measure			
(MHz)	(dB)	(dB)	(dB)	(dB)	K	Measure	(dBm)	(dBm)	(dB)
20	15.29	24.09	29.20	15.76	1.53	0.84	41.81	20.07	6.21
50	15.28	24.09	28.34	15.60	1.53	0.84	47.82	20.72	6.02
80	15.27	24.11	27.39	15.39	1.53	0.84	41.98	20.66	5.98
100	15.26	24.11	26.76	15.27	1.53	0.84	41.89	20.51	5.94
200	15.23	24.11	26.69	15.23	1.53	0.84	40.48	20.72	5.90
300	15.22	24.09	29.20	15.85	1.53	0.84	43.06	20.77	5.97
400	15.20	24.06	29.39	16.05	1.54	0.84	40.54	20.74	5.91
500	15.17	24.04	29.75	15.95	1.53	0.84	43.43	20.87	5.87
600	15.12	24.01	29.09	15.69	1.53	0.84	42.42	20.76	5.90
700	15.08	23.97	27.81	15.41	1.53	0.84	42.55	20.75	5.94
800	15.04	23.93	27.31	15.24	1.52	0.84	42.07	20.72	5.91
900	14.98	23.88	25.90	14.97	1.52	0.85	41.78	20.65	6.02
1000	14.93	23.83	24.79	14.76	1.51	0.85	42.09	20.84	5.98
1200	14.82	23.70	23.08	14.60	1.50	0.85	41.16	20.77	6.08
1400	14.66	23.60	21.16	13.77	1.49	0.85	40.22	20.69	6.11
1600	14.50	23.48	19.58	13.09	1.48	0.85	40.03	20.74	6.11
1800	14.31	23.37	18.28	12.38	1.46	0.85	39.35	20.66	6.18
2000	14.15	23.22	17.29	11.93	1.45	0.85	40.80	20.80	6.16
2200	13.96	23.09	16.53	11.33	1.43	0.85	40.00	20.87	6.16
2400	13.80	22.94	15.88	10.87	1.41	0.85	38.24	20.66	6.14
2600	13.60	22.81	15.61	10.42	1.40	0.85	38.10	20.56	6.15
2800	13.45	22.63	15.18	10.22	1.38	0.85	37.15	20.49	6.17
3000	13.30	22.45	15.07	10.12	1.37	0.85	37.50	20.54	6.20
3200	13.12	22.30	14.85	9.94	1.37	0.85	37.37	20.73	6.23
3400	12.92	22.15	14.60	9.65	1.36	0.84	36.49	20.57	6.27
3600	12.74	22.00	14.39	9.54	1.36	0.84	36.40	20.57	6.30
3800	12.54	21.87	13.81	9.57	1.36	0.85	36.06	20.30	6.35
4000	12.30	21.79	13.11	9.32	1.37	0.85	36.23	20.46	6.38
4200	12.02	21.72	12.50	9.05	1.38	0.85	36.00	20.38	6.37
4400	11.72	21.68	11.94	8.75	1.38	0.85	35.65	20.16	6.46
4600	11.46	21.61	11.40	8.62	1.39	0.86	35.48	20.07	6.56
4800	11.20	21.56	11.04	8.48	1.40	0.87	34.98	19.83	6.52
5000	10.92	21.49	10.82	8.19	1.41	0.86	34.04	19.35	6.63
5200	10.63	21.43	10.49	8.02	1.42	0.87	34.44	19.42	6.69
5400	10.37	21.36	10.19	7.95	1.43	0.87	34.77	19.35	6.71
5600	10.07	21.26	9.93	7.84	1.44	0.88	34.63	19.40	6.80
5800	9.85	21.24	9.63	7.65	1.46	0.87	34.37	19.27	6.67
6000	9.51	21.23	9.36	7.58	1.49	0.88	33.66	18.99	6.91
6200	9.24	21.22	8.94	7.37	1.50	0.88	33.69	18.77	6.86
6400	8.91	21.21	8.66	7.16	1.52	0.88	33.79	18.74	7.03
6600	8.52	21.25	8.18	7.01	1.56	0.88	33.82	18.74	7.11
6800	8.11	21.37	7.81	6.64	1.58	0.88	33.48	18.40	7.22
7000	7.65	21.53	7.44	6.43	1.64	0.88	33.42	18.12	7.36

Typical Performance Data

Definitions:

Input Return Loss = -S11 (dB)

Gain(Power Gain) = S21 (dB)

Reverse Isolation = -S12 (dB)

Output Return Loss = -S22 (dB)

TEST CONDITIONS: Vd = 5.00V, Id = 105.56mA @ Temperature = +85°C

FREQ	Gain	Isolation	Input Return Loss	Output Return Loss	Stability		IP-3 Output	1dB Comp. Output	Noise Figure
					K	Measure			
(MHz)	(dB)	(dB)	(dB)	(dB)	K	Measure	(dBm)	(dBm)	(dB)
20	15.34	24.19	33.42	16.55	1.54	0.85	41.53	19.83	7.42
50	15.34	24.20	34.48	16.71	1.54	0.85	39.52	20.50	7.24
80	15.33	24.21	36.47	16.95	1.54	0.85	40.26	20.41	7.23
100	15.32	24.21	38.00	17.12	1.54	0.85	41.80	20.23	7.23
200	15.28	24.21	37.07	17.30	1.55	0.85	41.70	20.44	7.25
300	15.23	24.22	32.47	16.68	1.55	0.85	41.03	20.49	7.19
400	15.18	24.21	30.79	16.32	1.56	0.85	39.42	20.45	7.26
500	15.15	24.19	29.94	16.25	1.56	0.85	39.92	20.60	7.24
600	15.09	24.17	28.55	16.07	1.56	0.85	39.68	20.46	7.28
700	15.04	24.14	27.07	15.67	1.56	0.85	39.52	20.44	7.33
800	14.99	24.10	25.97	15.34	1.55	0.85	38.97	20.41	7.33
900	14.92	24.06	25.10	15.04	1.55	0.85	38.54	20.28	7.41
1000	14.86	24.01	24.17	14.74	1.55	0.85	38.10	20.52	7.41
1200	14.72	23.90	22.48	14.07	1.54	0.85	37.84	20.43	7.49
1400	14.57	23.78	21.08	13.51	1.52	0.86	37.50	20.35	7.55
1600	14.42	23.64	19.72	12.97	1.51	0.86	36.74	20.40	7.58
1800	14.24	23.51	18.51	12.47	1.50	0.86	36.36	20.31	7.62
2000	14.05	23.36	17.44	11.95	1.48	0.86	36.56	20.50	7.61
2200	13.86	23.23	16.50	11.49	1.47	0.86	35.91	20.53	7.64
2400	13.67	23.07	15.64	11.13	1.45	0.86	35.27	20.13	7.65
2600	13.45	22.95	15.07	10.85	1.45	0.87	34.77	20.09	7.67
2800	13.25	22.79	14.51	10.58	1.43	0.87	34.19	19.85	7.71
3000	13.03	22.66	14.06	10.43	1.43	0.87	34.51	20.03	7.75
3200	12.81	22.51	13.74	10.31	1.43	0.88	33.68	19.99	7.80
3400	12.59	22.38	13.42	10.19	1.43	0.88	33.45	19.80	7.82
3600	12.36	22.22	13.16	10.15	1.44	0.88	33.29	19.70	7.86
3800	12.13	22.09	12.86	10.09	1.45	0.88	32.94	19.41	7.94
4000	11.86	21.98	12.52	9.85	1.46	0.88	32.74	19.55	7.95
4200	11.58	21.92	12.15	9.57	1.47	0.88	32.51	19.44	7.94
4400	11.26	21.84	11.72	9.27	1.49	0.88	32.38	19.18	8.05
4600	10.94	21.81	11.23	8.88	1.50	0.88	31.98	18.92	8.14
4800	10.59	21.81	10.78	8.49	1.52	0.88	31.93	18.73	8.12
5000	10.21	21.81	10.34	8.17	1.55	0.88	31.25	18.13	8.27
5200	9.82	21.81	9.89	7.87	1.57	0.88	31.29	18.22	8.37
5400	9.44	21.83	9.58	7.68	1.61	0.89	31.52	18.21	8.38
5600	9.08	21.84	9.30	7.52	1.64	0.89	30.91	17.95	8.48
5800	8.69	21.83	9.03	7.44	1.68	0.90	30.57	17.72	8.53
6000	8.34	21.84	8.83	7.41	1.73	0.91	30.33	17.49	8.62
6200	8.02	21.83	8.75	7.46	1.79	0.91	30.32	17.38	8.67
6400	7.64	21.86	8.63	7.38	1.85	0.91	30.33	17.25	8.75
6600	7.32	21.83	8.54	7.44	1.91	0.92	29.66	17.05	8.87
6800	6.95	21.91	8.31	7.33	1.98	0.92	29.45	16.82	8.97
7000	6.55	21.99	8.14	7.17	2.06	0.92	29.41	16.57	9.09

Typical Performance Data

Definitions:

Input Return Loss = -S11 (dB)

Gain(Power Gain) = S21 (dB)

Reverse Isolation = -S12 (dB)

Output Return Loss = -S22 (dB)

TEST CONDITIONS: Vd = 4.75V, Id = 96.22mA @ Temperature = +85°C

FREQ	Gain	Isolation	Input Return Loss	Output Return Loss	Stability		IP-3 Output	1dB Comp. Output	Noise Figure
					K	Measure			
(MHz)	(dB)	(dB)	(dB)	(dB)	K	Measure	(dBm)	(dBm)	(dB)
20	15.30	24.13	31.85	16.34	1.53	0.84	38.17	19.07	7.25
50	15.29	24.13	32.86	16.50	1.54	0.84	39.73	19.70	7.11
80	15.29	24.14	34.32	16.73	1.54	0.85	37.71	19.61	7.10
100	15.28	24.14	35.52	16.89	1.54	0.85	39.21	19.45	7.10
200	15.24	24.15	35.61	17.07	1.55	0.85	38.33	19.64	7.09
300	15.19	24.15	31.40	16.46	1.55	0.85	38.56	19.68	7.16
400	15.14	24.15	29.98	16.13	1.55	0.85	38.10	19.66	7.14
500	15.11	24.12	29.39	16.06	1.55	0.85	38.48	19.79	7.12
600	15.05	24.10	28.15	15.88	1.55	0.85	38.98	19.66	7.14
700	15.00	24.07	26.74	15.50	1.55	0.85	38.91	19.64	7.19
800	14.95	24.03	25.76	15.17	1.55	0.85	38.06	19.61	7.18
900	14.88	23.99	24.86	14.88	1.54	0.85	37.23	19.50	7.27
1000	14.82	23.93	23.95	14.59	1.54	0.85	37.16	19.71	7.29
1200	14.68	23.82	22.37	13.93	1.53	0.85	36.89	19.62	7.35
1400	14.53	23.70	20.99	13.39	1.52	0.85	36.17	19.55	7.40
1600	14.37	23.55	19.64	12.86	1.50	0.85	36.22	19.61	7.44
1800	14.19	23.42	18.48	12.36	1.49	0.86	35.46	19.52	7.47
2000	14.00	23.26	17.42	11.86	1.47	0.86	35.84	19.68	7.48
2200	13.81	23.13	16.46	11.41	1.46	0.86	35.16	19.71	7.49
2400	13.62	22.97	15.62	11.04	1.44	0.86	34.33	19.39	7.49
2600	13.40	22.85	15.03	10.77	1.44	0.86	34.32	19.33	7.52
2800	13.19	22.69	14.50	10.50	1.42	0.87	33.79	19.15	7.55
3000	12.98	22.56	14.04	10.36	1.42	0.87	34.07	19.29	7.60
3200	12.76	22.41	13.72	10.24	1.42	0.87	33.38	19.29	7.61
3400	12.54	22.27	13.41	10.12	1.42	0.88	33.04	19.11	7.71
3600	12.31	22.12	13.16	10.09	1.43	0.88	32.62	19.04	7.71
3800	12.07	21.99	12.87	10.02	1.44	0.88	32.55	18.76	7.78
4000	11.80	21.88	12.53	9.79	1.45	0.88	32.42	18.91	7.82
4200	11.52	21.82	12.16	9.51	1.47	0.88	32.31	18.82	7.81
4400	11.21	21.74	11.74	9.22	1.48	0.88	31.99	18.56	7.90
4600	10.89	21.71	11.25	8.84	1.50	0.88	31.56	18.33	7.98
4800	10.54	21.70	10.80	8.45	1.52	0.88	31.58	18.16	7.95
5000	10.16	21.71	10.35	8.13	1.54	0.88	30.75	17.54	8.14
5200	9.77	21.72	9.90	7.83	1.56	0.88	31.11	17.67	8.18
5400	9.39	21.73	9.59	7.64	1.60	0.88	31.20	17.69	8.21
5600	9.02	21.75	9.32	7.48	1.63	0.89	30.71	17.44	8.29
5800	8.64	21.74	9.04	7.41	1.67	0.90	30.20	17.24	8.36
6000	8.30	21.74	8.85	7.37	1.72	0.90	30.15	17.02	8.46
6200	7.97	21.74	8.77	7.42	1.78	0.91	30.05	16.92	8.52
6400	7.60	21.77	8.64	7.35	1.84	0.91	30.08	16.84	8.60
6600	7.28	21.74	8.56	7.42	1.90	0.92	29.37	16.65	8.70
6800	6.91	21.82	8.33	7.31	1.97	0.92	29.20	16.42	8.78
7000	6.51	21.90	8.15	7.14	2.04	0.92	29.16	16.20	8.89

Typical Performance Data

Definitions:

Input Return Loss = -S11 (dB)

Gain(Power Gain) = S21 (dB)

Reverse Isolation = -S12 (dB)

Output Return Loss = -S22 (dB)

TEST CONDITIONS: Vd = 5.25V, Id = 114.99mA @ Temperature = +85°C

FREQ	Gain	Isolation	Input Return Loss	Output Return Loss	Stability		IP-3 Output	1dB Comp. Output	Noise Figure
					K	Measure			
(MHz)	(dB)	(dB)	(dB)	(dB)	K	Measure	(dBm)	(dBm)	(dB)
20	15.38	24.24	34.97	16.73	1.54	0.85	38.21	20.50	7.52
50	15.37	24.25	36.41	16.91	1.54	0.85	43.86	21.22	7.36
80	15.36	24.26	39.10	17.15	1.55	0.85	40.57	21.12	7.35
100	15.36	24.26	40.87	17.33	1.55	0.85	44.59	20.94	7.34
200	15.32	24.27	38.29	17.50	1.55	0.85	41.58	21.15	7.35
300	15.27	24.27	33.20	16.85	1.56	0.85	42.06	21.21	7.40
400	15.22	24.27	31.44	16.51	1.56	0.85	40.25	21.17	7.42
500	15.18	24.25	30.40	16.43	1.56	0.85	40.14	21.33	7.39
600	15.13	24.23	28.84	16.23	1.56	0.86	40.58	21.18	7.40
700	15.08	24.19	27.28	15.83	1.56	0.86	39.89	21.14	7.45
800	15.02	24.16	26.21	15.50	1.56	0.86	40.26	21.11	7.46
900	14.96	24.12	25.22	15.19	1.56	0.86	39.23	20.97	7.52
1000	14.90	24.07	24.27	14.88	1.55	0.86	39.32	21.25	7.55
1200	14.76	23.97	22.58	14.19	1.54	0.86	38.85	21.13	7.62
1400	14.61	23.85	21.14	13.63	1.53	0.86	38.17	21.03	7.68
1600	14.46	23.72	19.74	13.08	1.52	0.86	37.18	21.10	7.74
1800	14.28	23.59	18.54	12.58	1.50	0.86	37.26	21.01	7.75
2000	14.10	23.44	17.48	12.05	1.49	0.86	36.94	21.23	7.72
2200	13.90	23.31	16.52	11.59	1.47	0.86	36.55	21.25	7.78
2400	13.72	23.15	15.64	11.22	1.46	0.87	35.75	20.79	7.78
2600	13.50	23.04	15.07	10.93	1.45	0.87	35.38	20.76	7.81
2800	13.30	22.88	14.52	10.66	1.44	0.87	34.66	20.49	7.84
3000	13.08	22.75	14.06	10.51	1.44	0.88	34.86	20.70	7.89
3200	12.86	22.61	13.74	10.39	1.44	0.88	34.05	20.61	7.92
3400	12.65	22.47	13.42	10.26	1.44	0.88	33.93	20.40	7.96
3600	12.41	22.32	13.15	10.22	1.45	0.88	33.66	20.30	8.01
3800	12.18	22.19	12.86	10.16	1.46	0.89	33.33	19.99	8.07
4000	11.91	22.07	12.52	9.92	1.47	0.89	33.10	20.12	8.10
4200	11.63	22.01	12.14	9.64	1.48	0.89	32.94	19.98	8.07
4400	11.32	21.93	11.71	9.34	1.50	0.88	32.83	19.71	8.16
4600	11.00	21.90	11.22	8.95	1.51	0.88	32.37	19.44	8.29
4800	10.64	21.89	10.76	8.56	1.53	0.88	32.19	19.23	8.26
5000	10.26	21.90	10.31	8.23	1.56	0.88	31.44	18.64	8.42
5200	9.87	21.90	9.86	7.92	1.58	0.88	31.61	18.70	8.52
5400	9.49	21.92	9.55	7.73	1.62	0.89	31.54	18.66	8.51
5600	9.12	21.93	9.28	7.57	1.65	0.89	31.26	18.37	8.65
5800	8.74	21.92	9.01	7.49	1.69	0.90	30.86	18.12	8.66
6000	8.39	21.92	8.81	7.44	1.74	0.91	30.50	17.90	8.79
6200	8.06	21.92	8.72	7.50	1.80	0.91	30.46	17.75	8.83
6400	7.68	21.94	8.60	7.42	1.86	0.92	30.46	17.59	8.89
6600	7.36	21.91	8.51	7.49	1.92	0.92	29.75	17.36	9.03
6800	6.99	21.99	8.30	7.38	1.99	0.93	29.62	17.13	9.13
7000	6.59	22.06	8.12	7.21	2.07	0.92	29.54	16.89	9.29

Typical Performance Curves

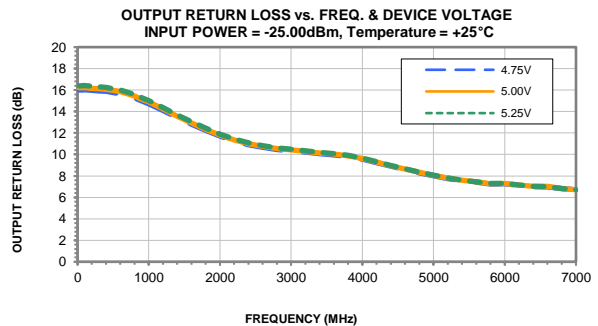
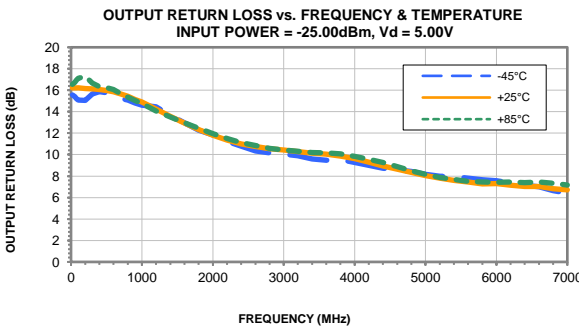
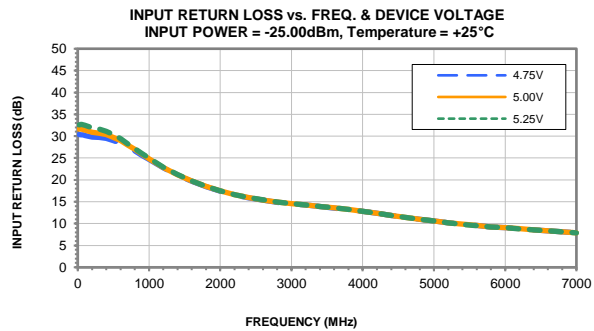
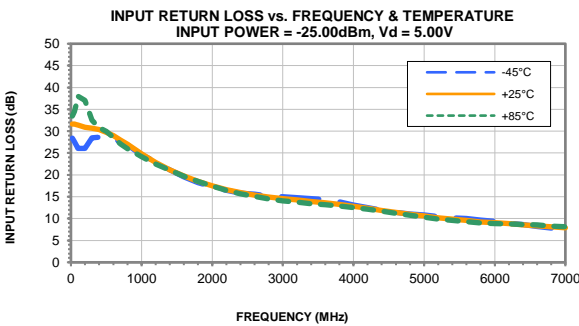
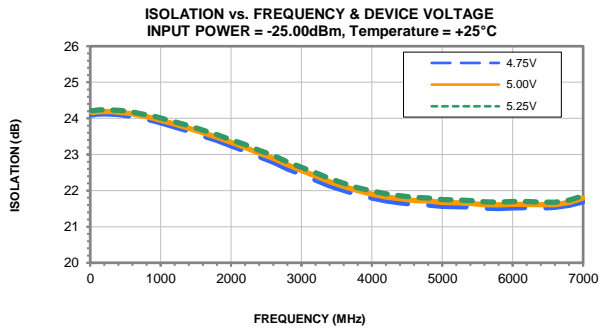
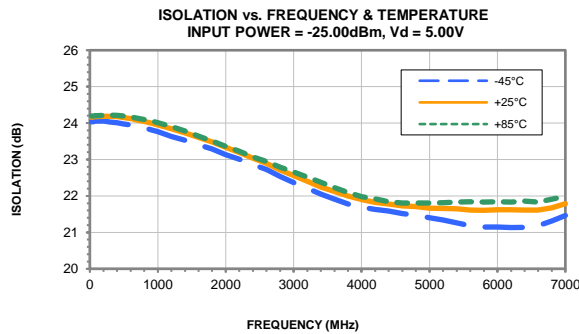
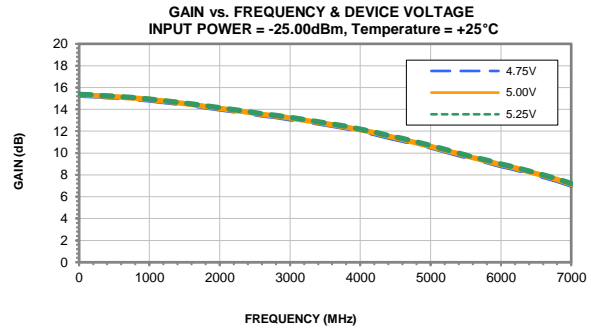
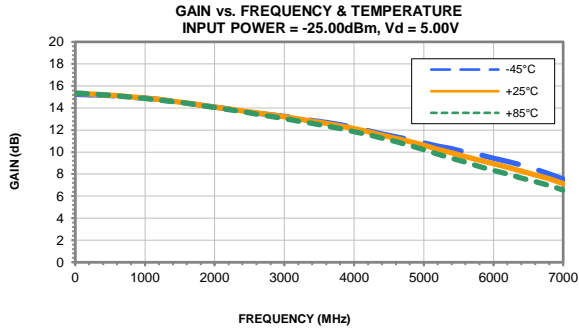

Typical Performance Curves

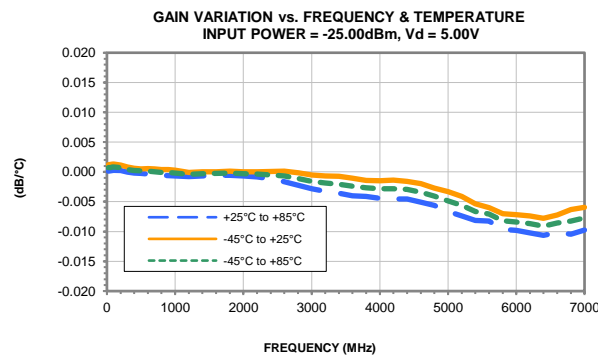
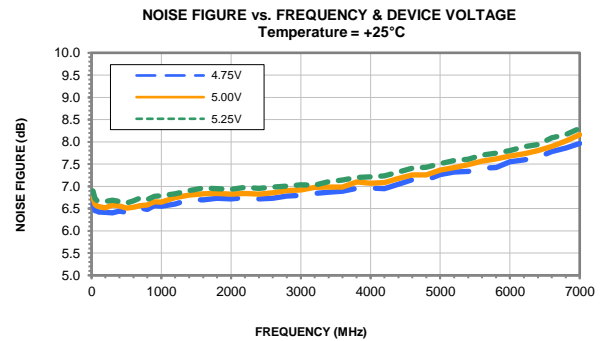
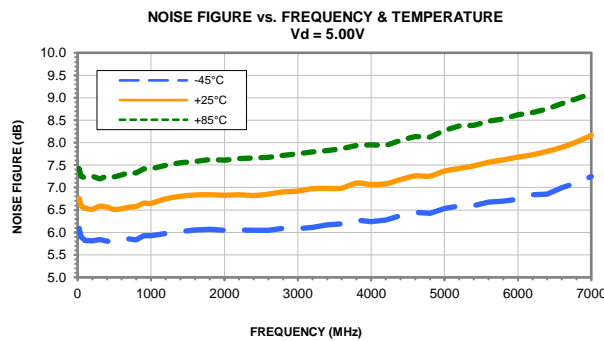
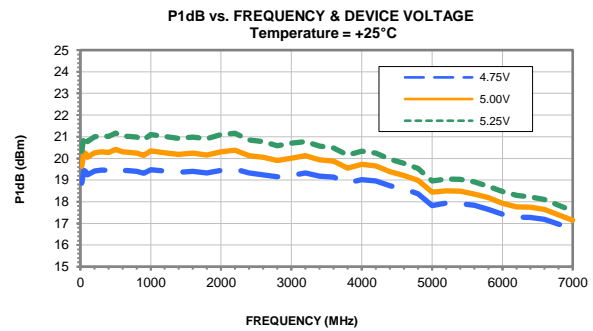
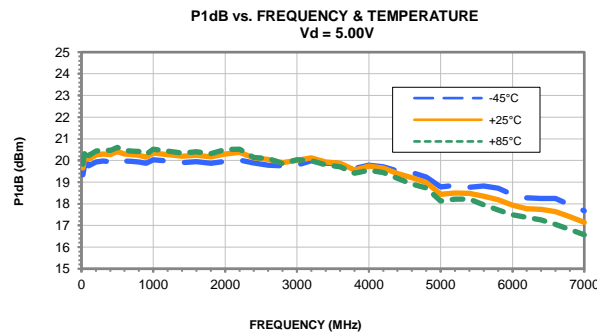
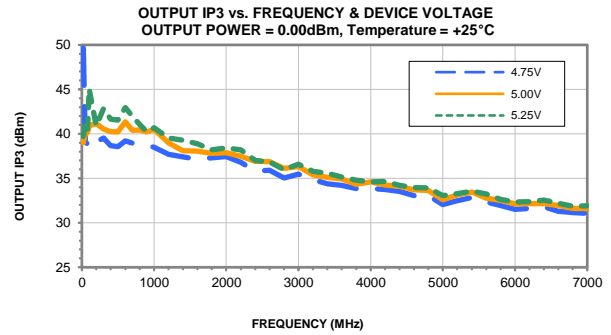
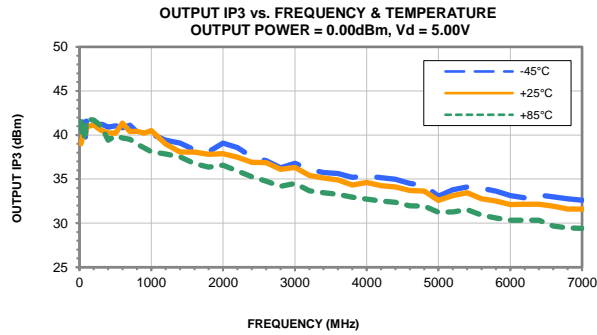

Outline Dimensions

JV2579

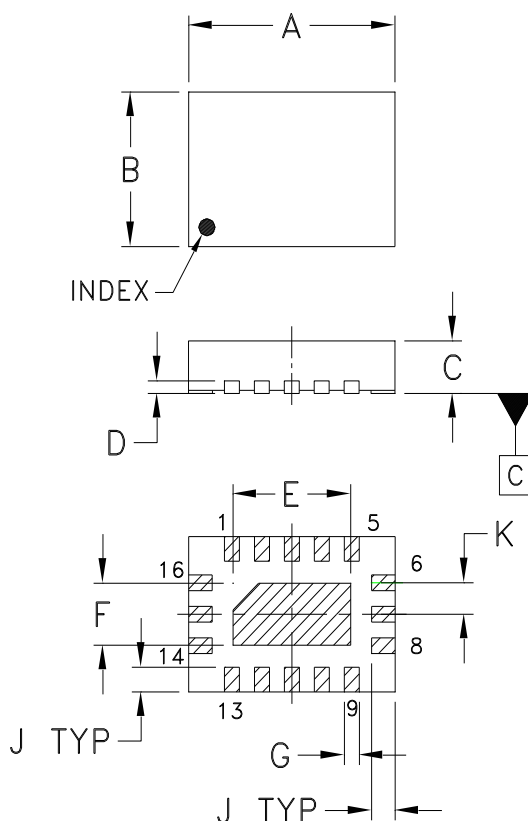

PCB Land Pattern

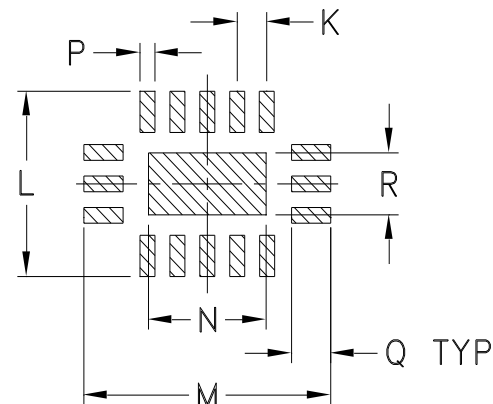

Suggested Layout,
Tolerance to be within $\pm .002$

CASE #	A	B	C	D	E	F	G	H	J	K	L	M	N
JV2579	.138 (3.5)	.098 (2.5)	.033 (0.85)	.008 (0.20)	.079 (2.01)	.039 (0.99)	.010 (0.25)	-	.016 (0.41)	.020 (.51)	.118 (3.00)	.165 (4.19)	.079 (2.01)

CASE #	P	Q	R	WT. GRAM
JV2579	.010 (0.25)	.026 (0.66)	.039 (0.99)	.03

Dimensions are in inches (mm). Tolerances: 2 Pl. $\pm .01$; 3 Pl. $\pm .005$

Notes:

1. Case material: Plastic.
2. Termination finish: **as shown below or indicated on Data Sheet.**
For RoHS Case Styles: Matte-Tin plate.



P.O. Box 350166, Brooklyn, New York 11235-0003 (718) 934-4500 Fax (718) 332-4661 For detailed performance specs & shopping online see Mini-Circuits web site



The Design Engineers Search Engine Provides ACTUAL Data Instantly From MINI-CIRCUITS At: www.minicircuits.com

RF/IF MICROWAVE COMPONENTS

Tape & Reel Packaging TR-F104



Tape Width, mm	Device Cavity Pitch, mm	Reel Size, inches	Devices per Reel	
8	4	7	Small quantity standards (see note)	20
				50
				100
				200
				500
				1000
		7	Standard	2000

Note: Please Consult individual model data sheet to determine device per reel availability.

Mini-Circuits carrier tape materials provide protection from ESD (Electro-Static Discharge) during handling and transportation. Tapes are static dissipative and comply with industry standards EIA-481/EIA-541.

Go to: www.minicircuits.com/pages/pdfs/tape.pdf



INTERNET <http://www.minicircuits.com>

P.O. Box 350166, Brooklyn, New York 11235-0003 (718) 934-4500 Fax (718) 332-4661

Distribution Centers NORTH AMERICA 800-654-7949 • 417-335-5935 • Fax 417-335-5945 • EUROPE 44-1252-832600 • Fax 44-1252-837010

Mini-Circuits ISO 9001 & ISO 14001 Certified

THIRD ANGLE PROJECTION

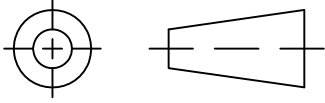

REVISIONS

REV	ECN No.	DESCRIPTION	DATE	DR	AUTH
OR	M167054	NEW RELEASE	04/11/18	ITG	RS

SUGGESTED MOUNTING CONFIGURATION
FOR JV2579 CASE STYLE, "16AM04" PIN CODE

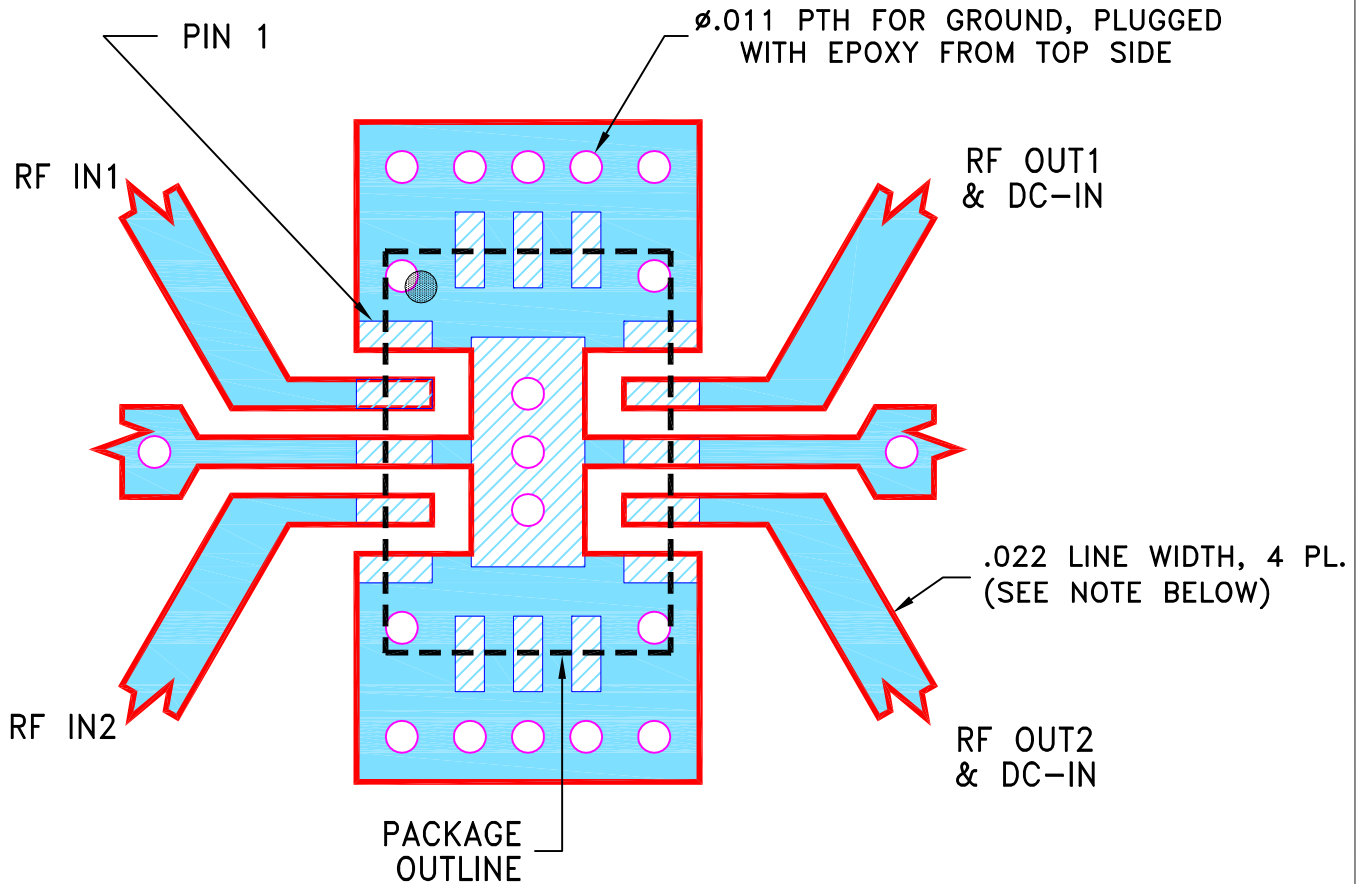

NOTES:

1. LINE WIDTH IS SHOWN FOR ROGERS R04350B WITH DIELECTRIC THICKNESS .010±.001. COPPER: 1/2 OZ. EACH SIDE. FOR OTHER MATERIALS TRACE WIDTH MAY NEED TO BE MODIFIED.
2. BOTTOM SIDE OF THE PCB IS CONTINUOUS GROUND PLANE.

- DENOTES PCB COPPER LAYOUT WITH SMOBC (SOLDER MASK OVER BARE COPPER).
- DENOTES COPPER LAND PATTERN FREE OF SOLDER MASK.

UNLESS OTHERWISE SPECIFIED	INITIALS		DATE
DIMENSIONS ARE IN INCHES TOLERANCES ON: 2 PL DECIMALS ± 3 PL DECIMALS ± .005 ANGLES ± FRACTIONS ±	DRAWN	ITG	04/09/18
	CHECKED	GF	04/11/18
	APPROVED	RS	04/11/18

Mini-Circuits® 13 Neptune Avenue
Brooklyn NY 11235

PL, 16AM04, JV2579, TB-1002+

Mini-Circuits®
 THIS DOCUMENT AND ITS CONTENTS ARE THE PROPERTY OF MINI-CIRCUITS. EXCEPT FOR USE EXPRESSLY GRANTED, IN WRITING, TO ITS VENDORS, VENDEE AND THE UNITED STATES GOVERNMENT, MINI-CIRCUITS RESERVES ALL PROPRIETARY DESIGN, USE, MANUFACTURING AND REPRODUCTION RIGHTS THERETO. THESE CONTENTS SHALL NOT BE USED, DUPLICATED OR DISCLOSED TO ANY OUTSIDE PARTY, IN WHOLE OR IN PART, WITHOUT WRITTEN PERMISSION OF MINI-CIRCUITS.

ASHEETA1.DWG REV:A DATE:01/12/95

SIZE	CODE IDENT	DRAWING NO:	REV:
A	15542	98-PL-582	OR
FILE:	98PL582	SCALE: 15:1	SHEET: 1 OF 1

Evaluation Board and Circuit

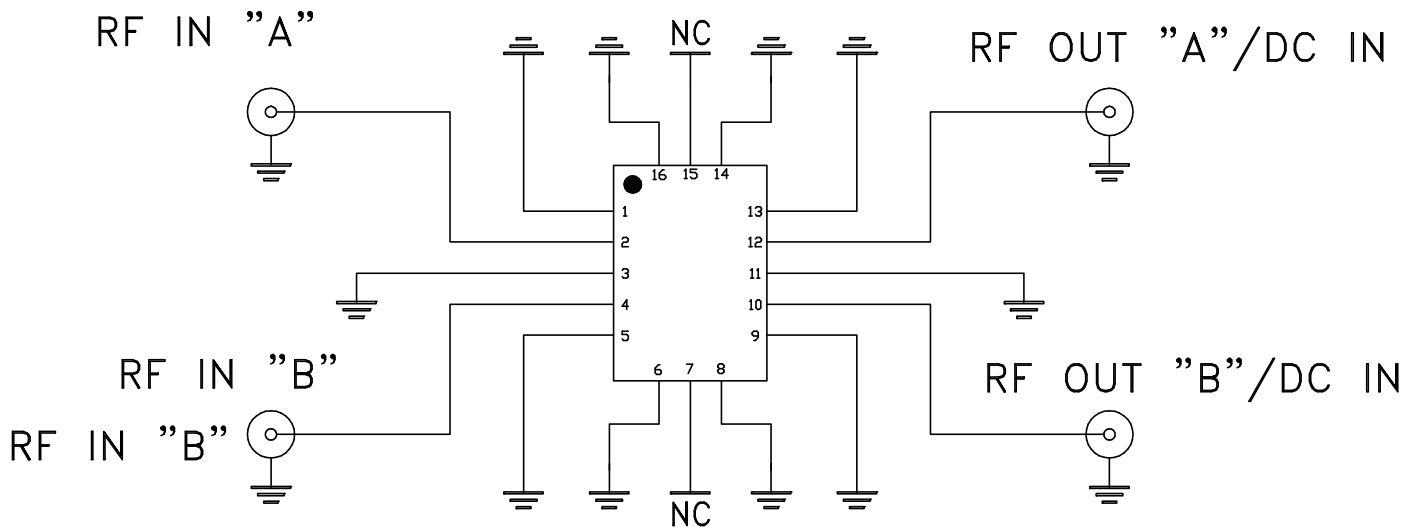
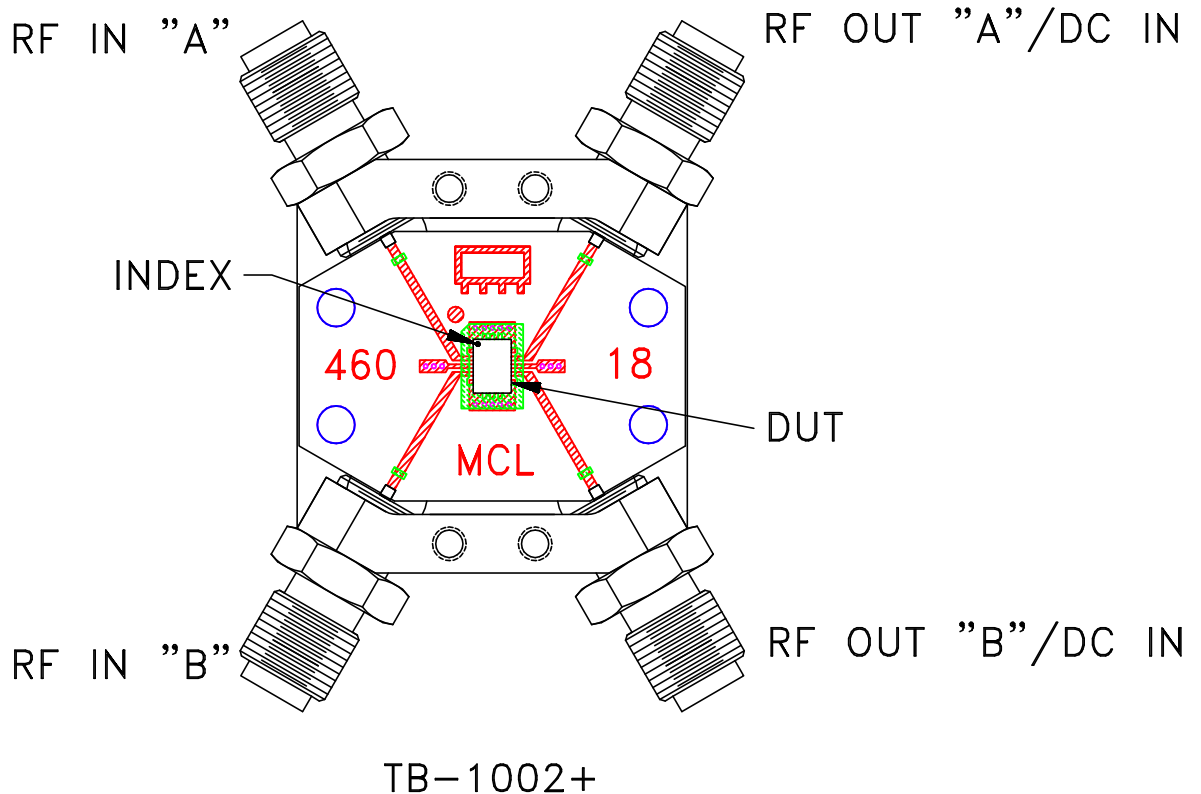

Schematic Diagram

NOTES:

1. SMA Female connectors.
2. PCB Material: Rogers R04350 or equivalent, Dielectric Constant=3.5, Thickness=.010 inch.

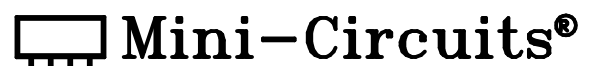

All Mini-Circuits products are manufactured under exacting quality assurance and control standards, and are capable of meeting published specifications after being subjected to any or all of the following physical and environmental test.

Specification	Test/Inspection Condition	Reference/Spec
Operating Temperature	-45° to 85°C or -40° to 85°C Ambient Environment	Individual Model Data Sheet
Storage Temperature	-65° to 150° C Ambient Environment	Individual Model Data Sheet
Thermal Shock	-55° to 100°C, 100 cycles	MIL-STD-202, Method 107, Condition A-3, except +100°C
Mechanical Shock	1.5Kg, 0.5 ms, 5 shock pulses, Y1 direction only	MIL-STD-883, Method 2002, Condition B, except Y1 direction only
Vibration (Variable Frequency)	50g peak	MIL-STD-883, Method 2007, Condition B
Autoclave	15 psig, 100% RH, 121°C, 96 hours	JESD22-A102, Condition C
HAST	130°C, 85% RH, 96 hours	JESD22-A110
Solderability	10X Magnification	J-STD-002, Para 4.2.5, Test S, 95% Coverage
Solder Reflow Heat	Sn-Pb Eutetic Process: 240°C peak Pb-Free Process: 260°C peak	J-STD-020, Table 4-1, 4-2 and 5-2; Figure 5-1
Moisture Sensitivity: Level 1	Bake at 125°C for 24 hours Soak at 85°C/85% RH for 168 hours, Reflow 3 cycles at 260°C peak	J-STD-020
Marking Resistance to Solvents	Isopropyl alcohol + mineral spirits at 25°C; terpene defluxer at 25°C; distilled water + proylene glycol monomethyl ether +	MIL-STD-202, Method 215



All Mini-Circuits products are manufactured under exacting quality assurance and control standards, and are capable of meeting published specifications after being subjected to any or all of the following physical and environmental test.

Specification	Test/Inspection Condition	Reference/Spec
	monoethanolamine at 63°C to 70°C	