

Ceramic, Hermetically Sealed, Wideband

## High Gain Mixer

### MRA-42LH+

Level 10 (LO Power+10 dBm) 1000 to 4200 MHz

#### Product Features

- wide bandwidth, 1000 to 4200 MHz
- excellent conversion gain, 11.5 dB typ.
- excellent L-R isolation, 33 dB typ.
- LTCC double balanced mixer
- aqueous washable
- low cost
- small size, .300"x.250"x.060"
- ceramic, hermetic, nitrogen filled



CASE STYLE: DZ1650

#### +RoHS Compliant

The +Suffix identifies RoHS Compliance. See our web site for RoHS Compliance methodologies and qualifications

#### Typical Applications

- cellular
- PCN
- fixed satellite
- WCDMA
- defense radar
- defense communications

**Model is not recommended for new designs and will be discontinued**

#### General Description

The MRA-42LH+ combines a double balance mixer with a highly linear, low noise IF amplifier to provide a high gain active mixer for efficient operation from 1000 MHz to 4200 MHz. The MRA-42LH+, due to its ultra compact size, offers the additional flexibility to enable the user to install design specific components (i.e., filters, attenuators, switches...) based upon the design needs.

The Schottky diode and MMIC amplifier are bonded to a multilayer integrated LTCC substrate, and then sealed under a controlled nitrogen atmosphere with gold plated covers and eutectic Au-Sn solder. These very compact active mixers have been tested to MIL requirements for gross leak, fine leak, thermal shock, vibration, acceleration, mechanical shock and HTOL.

#### Functional Schematic

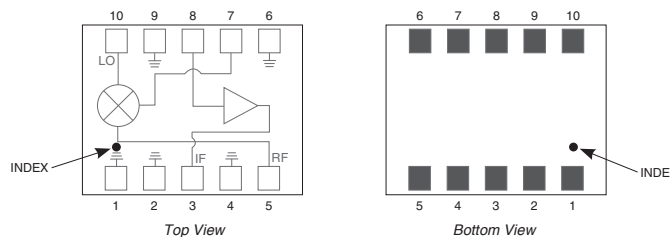

Function	Pad Number	Description
RF	5	RF
LO	10	LO
IF	3	IF
GND	1,2,4,6,9	Connected to ground
	7,8	Connected externally (see Application Circuit, Fig 2)

#### Notes

- A. Performance and quality attributes and conditions not expressly stated in this specification document are intended to be excluded and do not form a part of this specification document.  
 B. Electrical specifications and performance data contained in this specification document are based on Mini-Circuit's applicable established test performance criteria and measurement instructions.  
 C. The parts covered by this specification document are subject to Mini-Circuits standard limited warranty and terms and conditions (collectively, "Standard Terms"); Purchasers of this part are entitled to the rights and benefits contained therein. For a full statement of the Standard Terms and the exclusive rights and remedies thereunder, please visit Mini-Circuits' website at [www.minicircuits.com/MCLStore/terms.jsp](http://www.minicircuits.com/MCLStore/terms.jsp)



# NON-CATALOG

Ceramic, Hermetically Sealed, Wideband High Gain Mixer

**MRA-42LH+**

## Electrical Specifications at 25°C

Parameter	Condition (MHz)	Min.	Typ.	Max.	Units
Frequency Range, LO/RF		1000		4200	MHz
Frequency Range, IF		10		800	MHz
Conversion Gain*	1000 - 4200	9.0	11.5		dB
Noise Figure	1000 - 4200		8.0		dB
LO to RF Isolation	1000 - 4200	25	35		dB
LO to IF Isolation	1000 - 4200	12	20		dB
Output IP3	1000 - 4200		21		dBm
RF Input Power at 1 dB Compression	1000 - 4200		4		dBm
DC Power	Volt		3		V
	Current			100	mA

\*Conversion Gain measured at 30 MHz IF.

## Absolute Maximum Ratings

Parameter	Ratings
Operating Temperature (ground lead)	-55°C to 125°C
Storage Temperature	-65°C to 150°C
RF Power	50 mW
DC Voltage	5 V

Permanent damage may occur if any of these limits are exceeded.

## Characterization Test Circuit

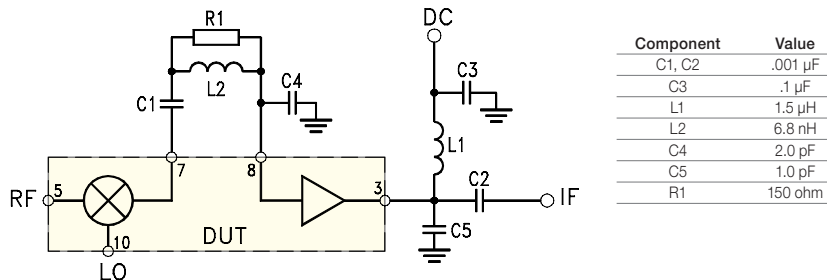

**Fig 1.** Block Diagram of Test Circuit used for characterization. (DUT soldered on Mini-Circuits Characterization Test Board TB-660+) Gain, Output power at 1dB compression (P1dB), Output IP3 (OIP3) are measured using R&S Network Analyzer ZVA-24. Noise Figure measured using Agilent's N8974A Noise Figure Analyzer

Conditions:

- Gain: RF Power=-15 dBm
- Output IP3 (OIP3): Two tones, spaced 1 MHz apart, 0 dBm/tone at output.
- DC voltage=3V

### Notes

- Performance and quality attributes and conditions not expressly stated in this specification document are intended to be excluded and do not form a part of this specification document.
- Electrical specifications and performance data contained in this specification document are based on Mini-Circuit's applicable established test performance criteria and measurement instructions.
- The parts covered by this specification document are subject to Mini-Circuits standard limited warranty and terms and conditions (collectively, "Standard Terms"); Purchasers of this part are entitled to the rights and benefits contained therein. For a full statement of the Standard Terms and the exclusive rights and remedies thereunder, please visit Mini-Circuits' website at [www.minicircuits.com/MCLStore/terms.jsp](http://www.minicircuits.com/MCLStore/terms.jsp)



# NON-CATALOG

Ceramic, Hermetically Sealed, Wideband High Gain Mixer

**MRA-42LH+**

## Typical Performance Curves

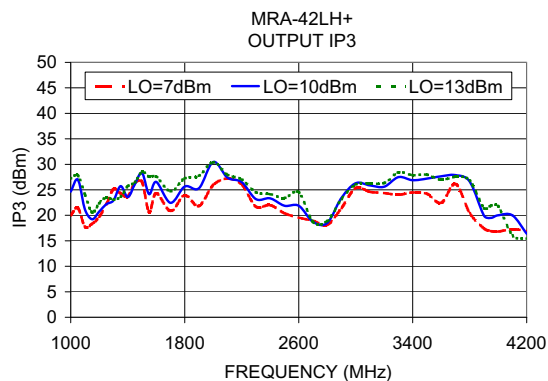
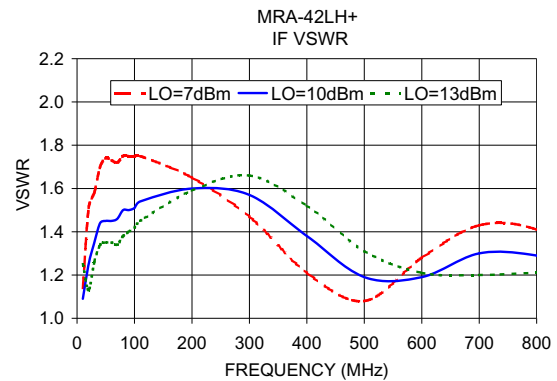
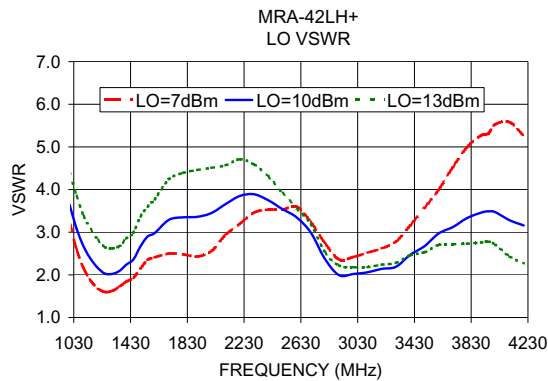
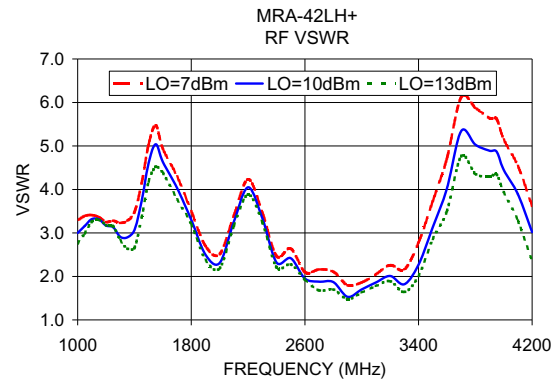
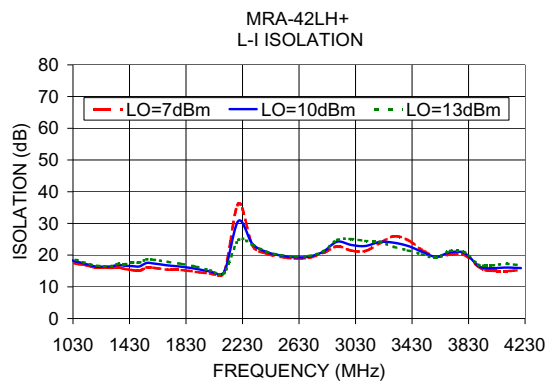
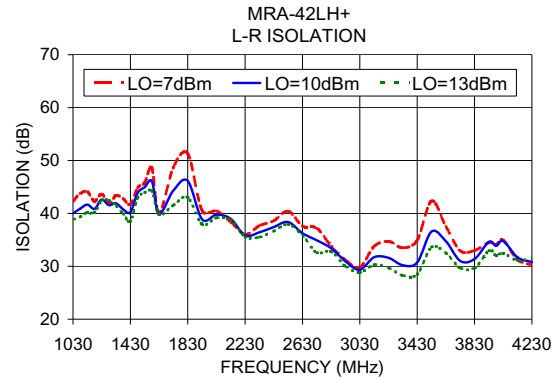
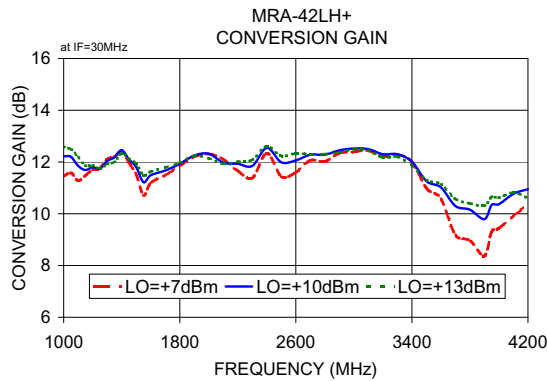

### Notes

- Performance and quality attributes and conditions not expressly stated in this specification document are intended to be excluded and do not form a part of this specification document.
- Electrical specifications and performance data contained in this specification document are based on Mini-Circuit's applicable established test performance criteria and measurement instructions.
- The parts covered by this specification document are subject to Mini-Circuits standard limited warranty and terms and conditions (collectively, "Standard Terms"); Purchasers of this part are entitled to the rights and benefits contained therein. For a full statement of the Standard Terms and the exclusive rights and remedies thereunder, please visit Mini-Circuits' website at [www.minicircuits.com/MCLStore/terms.jsp](http://www.minicircuits.com/MCLStore/terms.jsp)



# NON-CATALOG

Ceramic, Hermetically Sealed, Wideband High Gain Mixer

**MRA-42LH+**

## Electrical Performance for Suggested Application Circuit

Parameter	Condition (MHz)	Min.	Typ.	Max.	Units
Frequency Range, LO/RF		1000		4200	MHz
Frequency Range, IF		10		800	MHz
Conversion Gain*	1000 - 4200		11.5		dB
Noise Figure	1000 - 4200		8.0		dB
LO to RF Isolation	1000 - 4200		35		dB
LO to IF Isolation	1000 - 4200		60		dB
Output IP3	1000 - 4200		21		dBm
RF Input Power at 1 dB Compression	1000 - 4200		4		dBm
DC Power	Volt		3		V
	Current		—		mA

## Suggested Application Circuit (Fig. 2)

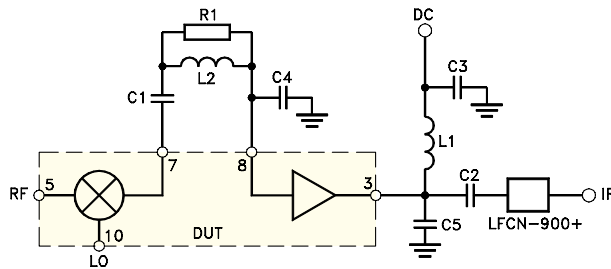

Component	Value
C1, C2	.001 $\mu$ F
C3	.1 $\mu$ F
L1	1.5 $\mu$ F
L2	6.8 nH
C4	2.0 pF
C5	1.0 pF
R1	150 ohm

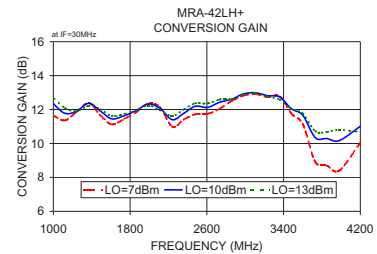
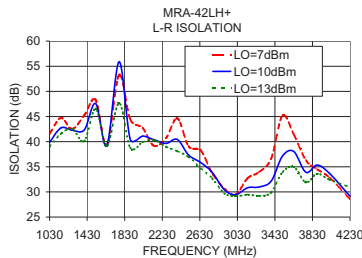
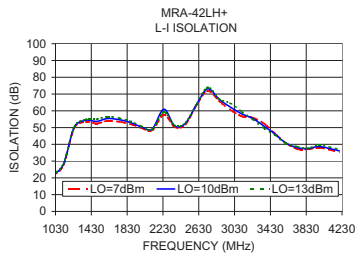

### Notes

- Performance and quality attributes and conditions not expressly stated in this specification document are intended to be excluded and do not form a part of this specification document.
- Electrical specifications and performance data contained in this specification document are based on Mini-Circuit's applicable established test performance criteria and measurement instructions.
- The parts covered by this specification document are subject to Mini-Circuits standard limited warranty and terms and conditions (collectively, "Standard Terms"); Purchasers of this part are entitled to the rights and benefits contained therein. For a full statement of the Standard Terms and the exclusive rights and remedies thereunder, please visit Mini-Circuits' website at [www.minicircuits.com/MCLStore/terms.jsp](http://www.minicircuits.com/MCLStore/terms.jsp)



# NON-CATALOG

Ceramic, Hermetically Sealed, Wideband High Gain Mixer

**MRA-42LH+**

## Additional Detailed Technical Information

additional information is available on our dash board. To access this information [click here](#)

<b>Performance Data</b>	Data Table
	Swept Graphs
<b>Case Style</b>	DZ1650
<b>Tape &amp; Reel</b> Standard quantities available on reel	F34 7" reels with 10, 20, 50, 100, 200 or 500 devices. 13" reels with 1K devices.
<b>Suggested Layout for PCB Design</b>	PL-369
<b>Evaluation Board</b>	TB-660-42LH+
<b>Environmental Ratings</b>	ENV-64

## ESD Rating

Human Body Model (HBM): Class 1B in accordance with ANSI/ESD STM 5.1 - 2001; passes 500V.

Machine Model (MM): Class M1 in accordance with ANSI/ESD STM5.2-1999; passes 20V

## MSL Rating

Moisture Sensitivity: MSL1

## Qualification Testing

Test Description		Test Method/Process	Results
1	Hermeticity (fine and gross leak)	MIL-STD-202 Method 112, Cond. C & D	Pass
2	Acceleration, 30Kg, Y1 Direction	MIL-STD-883 Method 2001 Cond. E	Pass
3	Vibration , 10-2000Hz sine, 20g, 3 axis	MIL-STD-202 Method 204, Cond. D	Pass
4	Mechanical shock	MIL-STD-202 Method 213, Cond . A	Pass
5	PIND 20G's @ 130 Hz	MIL-STD-750 Method 2052.2	Pass
6	Temp Cycle -55C/+125C, 1000 Cycles	MIL-STD-202 Method 107	Pass
7	Autoclave, 121C, RH 100%, 15 Psig, 96 hrs	JESD22-A102C	Pass
8	HTOL, 1000hrs, 105C at rated Voltage condition	MIL-STD-202 Method 108, Cond . D	Pass
9	Bend Test	JESD22-B113	Pass
10	Resistance to soldering heat, 3x reflow, 260C peak	JESD22-B102	Pass
11	Drop Test	JESD22-B111	Pass
12	Adhesion Strength	Push Test>10 lb	Pass

### Notes

- A. Performance and quality attributes and conditions not expressly stated in this specification document are intended to be excluded and do not form a part of this specification document.
- B. Electrical specifications and performance data contained in this specification document are based on Mini-Circuit's applicable established test performance criteria and measurement instructions.
- C. The parts covered by this specification document are subject to Mini-Circuits standard limited warranty and terms and conditions (collectively, "Standard Terms"); Purchasers of this part are entitled to the rights and benefits contained therein. For a full statement of the Standard Terms and the exclusive rights and remedies thereunder, please visit Mini-Circuits' website at [www.minicircuits.com/MCLStore/terms.jsp](http://www.minicircuits.com/MCLStore/terms.jsp)



# High Gain Mixer

# MRA-42LH+

## Typical Performance Data

RF (IN) (MHz)	LO (MHz)	CONVERSION GAIN IF FIXED @IF(OUT)=30MHz (dB)			RF (IN) (MHz)	LO (MHz)	IP-3 OUTPUT (dBm)			RF (IN) (MHz)	LO (MHz)	COMPRESSION @RF IN=+4dBm (dB)		
		@LO (dBm)					@LO (dBm)					@LO (dBm)		
		+7	+10	+13			+7	+10	+13			+7	+10	+13
1000.1	1030.1	12.57	12.80	12.91	1000.1	1030.1	21.55	22.21	22.20	1000.1	1030.1	2.38	2.22	2.02
1050.1	1080.1	12.47	12.63	12.69	1050.1	1080.1	22.09	22.35	22.01	1050.1	1080.1	2.24	2.01	1.79
1100.1	1130.1	12.10	12.32	12.42	1100.1	1130.1	20.81	21.70	21.72	1100.1	1130.1	1.82	1.67	1.51
1150.1	1180.1	11.85	12.01	12.13	1150.1	1180.1	18.13	19.25	20.22	1150.1	1180.1	1.64	1.50	1.39
1200.1	1230.1	11.81	11.88	11.90	1200.1	1230.1	19.38	20.46	20.99	1200.1	1230.1	1.55	1.39	1.25
1250.1	1280.1	11.80	11.79	11.78	1250.1	1280.1	19.87	20.57	20.79	1250.1	1280.1	1.23	1.06	0.90
1300.1	1330.1	11.92	11.80	11.72	1300.1	1330.1	20.19	20.76	21.05	1300.1	1330.1	1.25	1.13	1.02
1350.1	1380.1	12.12	11.94	11.78	1350.1	1380.1	22.09	21.46	22.10	1350.1	1380.1	1.14	0.97	0.88
1400.1	1430.1	12.36	12.19	11.97	1400.1	1430.1	22.98	23.45	23.46	1400.1	1430.1	1.21	1.03	0.89
1450.1	1480.1	12.25	12.19	12.04	1450.1	1480.1	24.33	24.74	24.80	1450.1	1480.1	1.10	0.97	0.81
1500.1	1530.1	11.93	11.97	11.91	1500.1	1530.1	25.35	25.54	25.36	1500.1	1530.1	0.98	0.88	0.75
1550.1	1580.1	11.59	11.69	11.69	1550.1	1580.1	24.17	24.78	24.30	1550.1	1580.1	0.85	0.74	0.63
1600.1	1630.1	11.49	11.58	11.61	1600.1	1630.1	24.70	24.97	24.62	1600.1	1630.1	0.84	0.77	0.70
1650.1	1680.1	11.43	11.53	11.57	1650.1	1680.1	20.46	21.00	21.50	1650.1	1680.1	0.86	0.78	0.71
1700.1	1730.1	11.53	11.61	11.63	1700.1	1730.1	21.27	22.61	23.15	1700.1	1730.1	1.10	1.00	0.88
1800.1	1830.1	11.82	11.85	11.84	1800.1	1830.1	23.78	24.41	24.50	1800.1	1830.1	1.13	1.00	0.92
1900.1	1930.1	12.15	12.12	12.06	1900.1	1930.1	23.97	25.48	25.59	1900.1	1930.1	0.97	0.86	0.83
2000.1	2030.1	12.25	12.14	12.01	2000.1	2030.1	27.41	27.20	26.77	2000.1	2030.1	0.60	0.54	0.53
2100.1	2130.1	12.06	11.89	11.70	2100.1	2130.1	25.35	25.71	26.04	2100.1	2130.1	0.77	0.64	0.59
2200.1	2230.1	12.11	12.16	12.16	2200.1	2230.1	24.19	24.51	24.92	2200.1	2230.1	1.33	1.18	1.03
2300.1	2330.1	12.05	12.21	12.30	2300.1	2330.1	21.03	21.97	22.65	2300.1	2330.1	1.76	1.59	1.43
2400.1	2430.1	12.70	12.75	12.74	2400.1	2430.1	21.17	21.89	22.85	2400.1	2430.1	1.72	1.60	1.48
2500.1	2530.1	12.37	12.54	12.59	2500.1	2530.1	20.13	21.56	22.61	2500.1	2530.1	1.77	1.58	1.40
2600.1	2630.1	12.48	12.66	12.74	2600.1	2630.1	19.69	21.77	23.38	2600.1	2630.1	2.12	2.02	1.86
2700.1	2730.1	12.46	12.44	12.38	2700.1	2730.1	16.22	16.37	16.71	2700.1	2730.1	1.93	1.73	1.59
2800.1	2830.1	12.53	12.53	12.49	2800.1	2830.1	16.91	17.18	17.72	2800.1	2830.1	2.00	1.80	1.66
2900.1	2930.1	12.52	12.44	12.32	2900.1	2930.1	20.24	20.00	19.88	2900.1	2930.1	1.83	1.68	1.56
3000.1	3030.1	12.60	12.55	12.46	3000.1	3030.1	22.69	22.38	21.96	3000.1	3030.1	1.43	1.35	1.29
3100.1	3130.1	12.62	12.55	12.44	3100.1	3130.1	23.15	23.07	22.59	3100.1	3130.1	1.18	1.14	1.12
3200.1	3230.1	12.45	12.33	12.20	3200.1	3230.1	23.20	24.02	24.32	3200.1	3230.1	0.85	0.80	0.81
3300.1	3330.1	12.41	12.25	12.07	3300.1	3330.1	25.08	25.56	25.72	3300.1	3330.1	0.84	0.73	0.68
3400.1	3430.1	12.25	12.09	11.92	3400.1	3430.1	24.79	25.55	25.87	3400.1	3430.1	1.32	1.08	0.92
3500.1	3530.1	11.68	11.61	11.50	3500.1	3530.1	24.65	24.94	24.83	3500.1	3530.1	1.43	1.27	1.20
3600.1	3630.1	11.60	11.59	11.53	3600.1	3630.1	24.36	24.28	24.41	3600.1	3630.1	0.99	0.84	0.83
3700.1	3730.1	11.33	11.46	11.45	3700.1	3730.1	23.53	23.81	24.01	3700.1	3730.1	1.49	1.41	1.35
3800.1	3830.1	10.85	10.92	10.85	3800.1	3830.1	23.20	21.84	19.76	3800.1	3830.1	1.11	1.18	1.32
3900.1	3930.1	10.69	10.81	10.21	3900.1	3930.1	18.29	18.62	16.31	3900.1	3930.1	1.53	1.72	1.67
4000.1	4030.1	10.93	11.03	10.31	4000.1	4030.1	18.05	18.26	14.78	4000.1	4030.1	1.69	2.00	2.05
4100.1	4130.1	11.28	10.41	8.43	4100.1	4130.1	16.36	13.56	21.42	4100.1	4130.1	2.17	1.88	0.93
4200.1	4230.1	11.30	10.33	9.20	4200.1	4230.1	14.50	13.90	15.88	4200.1	4230.1	2.29	1.70	1.28

# High Gain Mixer

# MRA-42LH+

## Typical Performance Data

IF (OUT) (MHz)	LO (MHz)	CONVERSION GAIN VS. IF FREQUENCY @RF(IN)=2600.1MHz (dB)
		@LO (dBm)
		+10
1800.0	800.1	-10.84
1710.0	890.1	-8.37
1620.0	980.1	-6.86
1530.0	1070.1	-4.94
1440.0	1160.1	-1.70
1350.0	1250.1	0.77
1260.0	1340.1	4.33
1170.0	1430.1	5.36
1070.0	1530.1	6.35
980.0	1620.1	5.88
890.0	1710.1	6.42
800.0	1800.1	7.21
710.0	1890.1	8.31
600.0	2000.1	9.22
530.0	2070.1	9.27
440.0	2160.1	9.95
340.0	2260.1	10.56
250.0	2350.1	10.86
160.0	2440.1	10.75
70.0	2530.1	11.43
20.0	2620.1	13.50
110.0	2710.1	9.92
200.0	2800.1	10.00
290.0	2890.1	9.99
380.0	2980.1	9.85
470.0	3070.1	9.80
560.0	3160.1	9.98
650.0	3250.1	9.77
750.0	3350.1	9.01
840.0	3440.1	8.06
930.0	3530.1	6.99
1020.0	3620.1	6.10
1110.0	3710.1	4.72
1200.0	3800.1	3.13
1290.0	3890.1	1.30
1380.0	3980.1	-0.22
1480.0	4080.1	-2.69
1570.0	4170.1	-5.03
1660.0	4260.1	-8.37
1750.0	4350.1	-11.81

IF (OUT) (MHz)	LO (MHz)	CONVERSION GAIN VS. IF FREQUENCY @RF(IN)=1000.1MHz (dB)
		@LO (dBm)
		+10
20.0	1020.1	13.81
70.0	1070.1	11.64
120.0	1120.1	11.30
170.0	1170.1	11.04
220.0	1220.1	10.84
270.0	1270.1	10.73
320.0	1320.1	10.64
370.0	1370.1	10.39
420.0	1420.1	10.08
470.0	1470.1	9.68
520.0	1520.1	9.41
570.0	1570.1	9.06
620.0	1620.1	8.85
680.0	1680.1	8.84
730.0	1730.1	8.82
780.0	1780.1	8.79
830.0	1830.1	8.53
880.0	1880.1	8.00
930.0	1930.1	7.62
980.0	1980.1	7.18
1030.0	2030.1	6.39
1080.0	2080.1	5.92
1130.0	2130.1	5.04
1180.0	2180.1	4.16
1230.0	2230.1	2.93
1280.0	2280.1	1.68
1340.0	2340.1	0.65
1390.0	2390.1	-0.60
1440.0	2440.1	-1.94
1490.0	2490.1	-3.50
1540.0	2540.1	-4.66
1590.0	2590.1	-6.10
1640.0	2640.1	-6.80
1690.0	2690.1	-7.85
1740.0	2740.1	-8.43
1790.0	2790.1	-9.56
1840.0	2840.1	-11.07
1890.0	2890.1	-13.06
1940.0	2940.1	-14.47
2000.0	3000.1	-16.09

IF (OUT) (MHz)	LO (MHz)	CONVERSION GAIN VS. IF FREQUENCY @RF(IN)=4200.1MHz (dB)
		@LO (dBm)
		+10
1900.0	2300.1	-15.07
1860.0	2340.1	-12.87
1810.0	2390.1	-10.44
1760.0	2440.1	-9.30
1710.0	2490.1	-8.34
1660.0	2540.1	-7.30
1620.0	2580.1	-6.50
1570.0	2630.1	-5.62
1520.0	2680.1	-4.61
1470.0	2730.1	-3.52
1420.0	2780.1	-1.87
1370.0	2830.1	-0.45
1330.0	2870.1	0.89
1280.0	2920.1	1.94
1230.0	2970.1	2.73
1180.0	3020.1	2.86
1130.0	3070.1	3.31
1090.0	3110.1	3.57
1040.0	3160.1	4.43
990.0	3210.1	5.06
940.0	3260.1	5.50
890.0	3310.1	5.96
840.0	3360.1	6.82
800.0	3400.1	7.06
750.0	3450.1	7.31
700.0	3500.1	7.66
650.0	3550.1	7.93
600.0	3600.1	7.96
560.0	3640.1	8.29
510.0	3690.1	8.90
460.0	3740.1	9.36
410.0	3790.1	9.38
360.0	3840.1	9.68
310.0	3890.1	10.37
270.0	3930.1	10.58
200.0	4000.1	10.70
170.0	4030.1	10.57
120.0	4080.1	10.42
70.0	4130.1	10.12
20.0	4180.1	11.40

# High Gain Mixer

# MRA-42LH+

## Typical Performance Data

LO (MHz)	LO-RF ISOLATION (dB)			LO-IF ISOLATION (dB)		
	@LO (dBm)			@LO (dBm)		
	+7	+10	+13	+7	+10	+13
1030.1	39.20	38.38	37.85	18.88	19.09	19.17
1080.1	40.04	38.99	38.34	18.22	18.62	18.78
1130.1	40.73	39.66	39.02	17.48	17.74	17.88
1180.1	39.98	39.42	39.11	16.69	16.89	17.01
1230.1	42.09	42.05	42.33	16.05	16.34	16.50
1280.1	41.26	42.06	42.69	15.73	15.87	15.97
1330.1	41.26	41.17	41.12	15.62	15.77	15.89
1380.1	39.60	39.18	38.90	16.22	16.37	16.46
1430.1	39.35	37.75	37.18	16.17	16.46	16.63
1480.1	42.33	41.23	40.04	16.39	17.37	18.08
1530.1	43.90	42.79	41.45	16.11	17.19	18.11
1580.1	45.55	44.35	43.68	17.18	18.21	19.05
1630.1	40.28	40.13	39.72	16.95	18.05	18.97
1680.1	42.24	42.01	41.65	16.76	17.99	18.99
1730.1	43.59	41.70	40.51	16.17	17.22	18.09
1830.1	45.32	42.66	40.87	15.54	16.40	17.07
1930.1	38.35	37.64	37.06	14.95	15.57	15.98
2030.1	39.02	38.54	38.11	14.02	14.27	14.37
2130.1	39.11	38.75	38.02	13.19	12.88	12.51
2230.1	36.22	35.97	35.55	25.14	21.85	19.86
2330.1	37.01	36.11	35.30	24.26	23.69	22.91
2430.1	36.71	35.86	35.27	20.90	20.96	20.87
2530.1	37.97	37.64	37.98	19.64	19.74	19.73
2630.1	36.18	35.74	35.53	19.01	19.09	19.08
2730.1	33.94	32.51	32.21	19.23	19.31	19.28
2830.1	34.04	33.03	32.22	20.41	20.31	20.18
2930.1	31.56	30.47	29.67	24.02	23.88	23.51
3030.1	29.68	29.17	28.67	23.98	25.37	26.39
3130.1	31.29	30.09	29.21	23.30	24.78	26.07
3230.1	31.16	29.63	28.62	24.06	24.14	24.10
3330.1	29.24	27.86	26.95	23.12	22.21	21.62
3430.1	29.47	27.85	26.83	22.13	21.10	20.37
3530.1	34.36	32.27	31.02	20.51	19.89	19.35
3630.1	33.79	31.96	30.63	18.79	18.53	18.19
3730.1	30.86	29.81	29.03	19.02	19.41	19.57
3830.1	30.76	29.46	28.32	20.16	20.71	21.10
3930.1	33.87	31.89	29.92	21.77	22.39	23.05
4030.1	33.53	31.68	29.63	19.52	20.44	21.23
4130.1	31.22	30.04	27.64	18.35	19.42	19.83
4230.1	30.64	30.18	26.56	17.30	18.02	18.18

RF (IN) (MHz)	LO (MHz)	RF-IF ISOLATION (dB)		
		@LO (dBm)		
		+7	+10	+13
1000.1	1030.1	-0.67	-1.18	-1.53
1050.1	1080.1	0.52	-0.05	-0.45
1100.1	1130.1	2.01	1.36	0.92
1150.1	1180.1	5.01	4.23	3.58
1200.1	1230.1	7.68	6.73	6.07
1250.1	1280.1	11.20	9.78	8.85
1300.1	1330.1	13.84	12.80	11.84
1350.1	1380.1	13.31	11.98	11.15
1400.1	1430.1	12.46	11.44	10.55
1450.1	1480.1	12.72	11.83	10.99
1500.1	1530.1	13.70	12.77	12.05
1550.1	1580.1	15.11	14.50	14.04
1600.1	1630.1	17.67	17.31	16.99
1650.1	1680.1	19.73	19.37	19.07
1700.1	1730.1	21.43	20.85	20.38
1800.1	1830.1	22.19	21.91	21.49
1900.1	1930.1	21.76	21.32	20.82
2000.1	2030.1	21.03	20.70	20.18
2100.1	2130.1	22.01	22.14	21.84
2200.1	2230.1	33.14	35.34	36.67
2300.1	2330.1	39.72	36.22	32.78
2400.1	2430.1	31.26	29.57	27.61
2500.1	2530.1	28.38	27.08	25.58
2600.1	2630.1	25.39	24.25	22.94
2700.1	2730.1	23.32	22.84	22.28
2800.1	2830.1	20.64	20.09	19.58
2900.1	2930.1	17.24	17.15	17.35
3000.1	3030.1	17.42	17.48	17.65
3100.1	3130.1	19.15	19.22	19.24
3200.1	3230.1	20.45	20.33	20.09
3300.1	3330.1	20.52	20.05	19.54
3400.1	3430.1	18.92	18.34	17.78
3500.1	3530.1	27.15	26.34	25.28
3600.1	3630.1	23.54	22.75	21.97
3700.1	3730.1	27.13	25.86	24.75
3800.1	3830.1	28.93	27.16	25.67
3900.1	3930.1	42.34	35.63	32.00
4000.1	4030.1	34.03	33.39	31.94
4100.1	4130.1	31.05	33.89	36.76
4200.1	4230.1	31.98	36.88	33.29

# High Gain Mixer

# MRA-42LH+

## Typical Performance Data

RF (IN) (MHz)	LO (MHz)	RF VSWR (:1)			LO (MHz)	LO VSWR (:1)			IF (OUT) (MHz)	IF VSWR @LO=4200.1MHz (:1)		
		@LO (dBm)				@LO (dBm)				@LO (dBm)		
		+7	+10	+13		+7	+10	+13		+7	+10	+13
1000.1	1030.1	1.52	1.48	1.46	1030.1	3.17	3.54	4.27	10.1	1.31	1.29	1.11
1050.1	1080.1	1.57	1.54	1.52	1080.1	2.52	2.98	3.72	30.1	1.23	1.23	1.21
1100.1	1130.1	1.69	1.67	1.66	1130.1	2.12	2.60	3.31	50.1	1.25	1.27	1.30
1150.1	1180.1	1.87	1.86	1.85	1180.1	1.84	2.33	3.01	70.1	1.28	1.27	1.29
1200.1	1230.1	1.98	1.99	1.99	1230.1	1.69	2.16	2.81	90.1	1.32	1.32	1.32
1250.1	1280.1	2.06	2.09	2.09	1280.1	1.64	2.05	2.68	110.1	1.37	1.37	1.39
1300.1	1330.1	2.13	2.20	2.21	1330.1	1.68	2.07	2.69	130.1	1.42	1.42	1.43
1350.1	1380.1	2.08	2.16	2.18	1380.1	1.79	2.16	2.76	150.1	1.48	1.47	1.47
1400.1	1430.1	1.80	1.88	1.90	1430.1	1.91	2.33	2.96	170.1	1.52	1.52	1.52
1450.1	1480.1	1.57	1.62	1.65	1480.1	1.99	2.44	3.10	190.1	1.59	1.59	1.57
1500.1	1530.1	1.62	1.67	1.70	1530.1	2.20	2.73	3.46	210.1	1.63	1.62	1.63
1550.1	1580.1	1.64	1.68	1.70	1580.1	2.38	2.94	3.67	230.1	1.68	1.69	1.69
1600.1	1630.1	1.69	1.73	1.75	1630.1	2.41	2.99	3.80	250.1	1.74	1.74	1.75
1650.1	1680.1	1.65	1.69	1.69	1680.1	2.33	3.01	3.88	270.1	1.81	1.80	1.82
1700.1	1730.1	1.67	1.70	1.68	1730.1	2.47	3.25	4.19	290.1	1.84	1.85	1.85
1800.1	1830.1	1.51	1.55	1.56	1830.1	2.43	3.28	4.28	310.1	1.87	1.88	1.88
1900.1	1930.1	1.28	1.31	1.32	1930.1	2.39	3.27	4.30	330.1	1.90	1.90	1.92
2000.1	2030.1	1.37	1.38	1.37	2030.1	2.50	3.32	4.29	350.1	1.95	1.96	1.96
2100.1	2130.1	1.65	1.65	1.63	2130.1	2.86	3.51	4.31	370.1	1.98	1.97	1.98
2200.1	2230.1	1.62	1.62	1.62	2230.1	3.09	3.66	4.42	390.1	1.97	1.98	1.99
2300.1	2330.1	1.55	1.55	1.55	2330.1	3.30	3.68	4.30	410.1	1.96	1.96	1.96
2400.1	2430.1	1.38	1.37	1.37	2430.1	3.38	3.55	4.06	430.1	1.95	1.95	1.95
2500.1	2530.1	1.58	1.57	1.57	2530.1	3.36	3.37	3.73	450.1	1.93	1.93	1.93
2600.1	2630.1	1.40	1.40	1.39	2630.1	3.39	3.14	3.35	470.1	1.90	1.90	1.90
2700.1	2730.1	1.41	1.40	1.40	2730.1	3.09	2.87	3.07	490.1	1.85	1.84	1.84
2800.1	2830.1	1.61	1.60	1.60	2830.1	2.64	2.32	2.51	510.1	1.78	1.78	1.78
2900.1	2930.1	1.71	1.71	1.71	2930.1	2.22	1.91	2.18	530.1	1.71	1.72	1.71
3000.1	3030.1	1.87	1.87	1.87	3030.1	2.29	1.95	2.16	550.1	1.66	1.65	1.65
3100.1	3130.1	2.08	2.08	2.08	3130.1	2.45	2.05	2.21	570.1	1.59	1.59	1.58
3200.1	3230.1	1.98	1.98	1.98	3230.1	2.63	2.17	2.29	590.1	1.52	1.52	1.51
3300.1	3330.1	1.57	1.57	1.57	3330.1	2.87	2.26	2.33	610.1	1.44	1.44	1.43
3400.1	3430.1	1.40	1.40	1.40	3430.1	3.35	2.58	2.53	630.1	1.39	1.38	1.38
3500.1	3530.1	1.60	1.61	1.61	3530.1	3.82	2.80	2.59	650.1	1.33	1.32	1.32
3600.1	3630.1	1.42	1.43	1.43	3630.1	4.24	3.09	2.74	670.1	1.27	1.26	1.26
3700.1	3730.1	1.65	1.66	1.66	3730.1	4.79	3.26	2.75	690.1	1.21	1.20	1.20
3800.1	3830.1	1.58	1.58	1.58	3830.1	5.17	3.42	2.73	710.1	1.16	1.15	1.15
3900.1	3930.1	1.37	1.37	1.36	3930.1	5.39	3.51	2.73	730.1	1.12	1.11	1.11
4000.1	4030.1	1.25	1.25	1.25	4030.1	5.49	3.43	2.61	750.1	1.09	1.09	1.08
4100.1	4130.1	1.18	1.21	1.23	4130.1	5.37	3.18	2.30	770.1	1.08	1.08	1.08
4200.1	4230.1	1.15	1.18	1.21	4230.1	5.06	3.06	2.14	800.1	1.11	1.11	1.11

## Harmonics Tables

RF HARMONICS ORDER

	(-dBm)	(-dBc)										
0	---	---	10.35	45.67	59.98	60.96	40.38	79.07	54.44	96.81	71.58	96.59
1	---	38.23	---	42.51	47.33	76.11	72.86	71.75	91.06	83.76	100.09	98.50
2	99.21	72.35	68.86	44.21	75.94	76.85	102.99	96.80	79.62	90.56	82.39	98.63
3	103.52	105.32	84.03	88.92	54.12	80.55	89.11	117.22	103.38	109.24	110.94	104.18
4	105.25	116.75	125.53	113.30	109.29	82.79	108.37	107.59	123.04	123.43	111.49	114.59
5	98.29	122.15	125.14	122.85	126.61	122.06	91.32	116.14	120.14	123.16	125.58	121.72
6	95.73	121.24	121.98	125.33	125.99	121.58	122.65	114.67	123.32	123.20	125.00	123.76
7	95.21	119.27	120.74	124.82	122.26	122.72	123.81	123.83	121.52	128.95	122.92	124.51
8	110.69	123.23	118.71	122.09	119.58	123.46	124.44	123.01	123.22	120.88	121.22	121.25
9	104.46	124.12	126.55	116.95	118.86	125.03	118.35	121.07	127.44	120.41	123.03	124.56
10	101.60	124.12	122.88	125.50	117.85	117.74	121.88	123.59	126.50	125.61	122.75	123.04
	RF CAL	0	1	2	3	4	5	6	7	8	9	10

### LO HARMONICS ORDER

Test conditions: RF IN: 2600.1 MHz; -10 dBm.  
 LO IN: 2630.1 MHz; +10.00 dBm  
 IF OUT: 30 MHz; 2.56 dBm

RF HARMONICS ORDER

	(-dBm)	(-dBc)										
0	---	---	19.89	59.04	72.86	74.13	52.32	83.23	70.43	96.49	87.73	103.55
1	---	37.13	---	42.68	48.56	77.78	77.62	74.74	89.28	83.28	110.45	102.08
2	91.08	58.90	54.57	28.67	61.80	68.20	87.75	87.09	74.98	87.30	81.56	99.50
3	89.63	78.76	57.56	69.08	31.18	58.85	74.42	97.24	91.41	93.05	103.59	88.70
4	92.17	95.39	100.01	80.94	69.93	49.71	78.06	85.94	108.62	97.55	92.21	95.75
5	87.32	92.12	88.56	96.98	76.53	85.05	45.29	69.48	87.32	114.36	97.40	104.48
6	84.86	112.43	95.39	104.81	102.46	84.66	84.43	57.06	95.39	89.01	117.40	105.86
7	87.96	103.54	102.36	113.87	103.41	113.24	86.00	91.64	61.03	76.78	100.40	114.14
8	95.54	123.40	109.98	110.35	106.75	106.48	111.55	91.94	94.02	61.85	88.26	96.93
9	96.73	122.11	122.75	113.19	111.87	101.90	112.63	120.06	98.82	97.98	72.26	81.88
10	92.88	121.10	121.11	127.68	115.30	121.14	110.34	113.81	124.12	97.58	105.88	74.09
	RF CAL	0	1	2	3	4	5	6	7	8	9	10

### LO HARMONICS ORDER

Test conditions: RF IN: 2600.1 MHz; 0 dBm.  
 LO IN: 2630.1 MHz; +10.00 dBm  
 IF OUT: 30 MHz; 12.09 dBm

- Notes: 1. All Harmonics are in (dBc) relative to IF OUTPUT  
 2. + entry denotes harmonics are in (dBc) above IF OUTPUT  
 3. RF Cal represents the Harmonics level of the RF Input Signal to the mixer

## Typical Performance Curves

Conversion Gain @IF=30 MHz

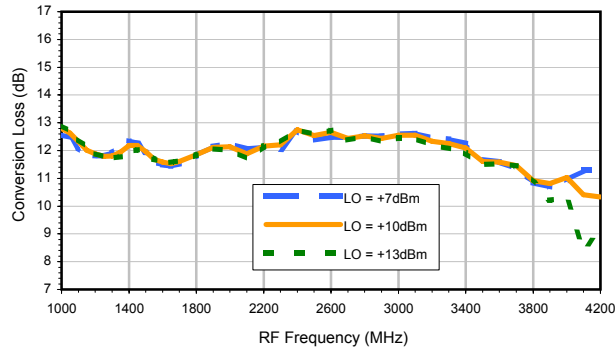

Conversion Gain vs. LO @ RF=2600.1 MHz

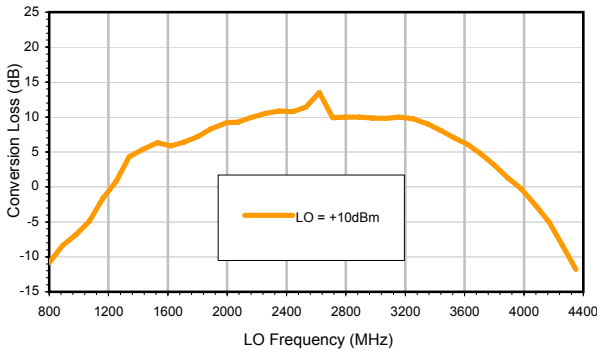

Conversion Gain vs. IF @ RF=2600.1 MHz

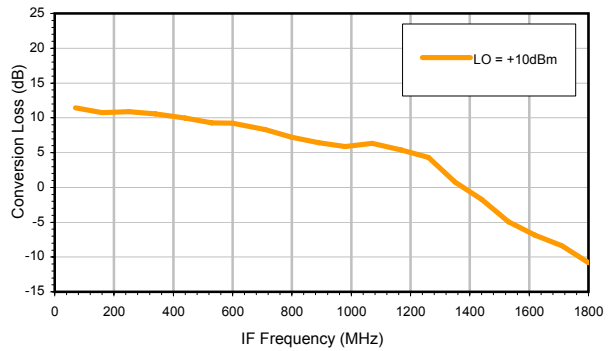

Conversion Gain vs. IF @ RF=1000.1 MHz

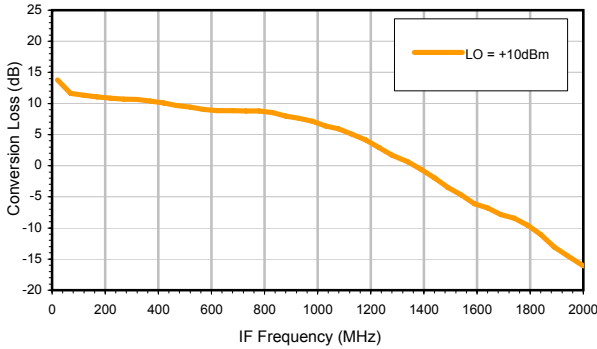

Conversion Gain vs. IF @ RF=4200.1 MHz

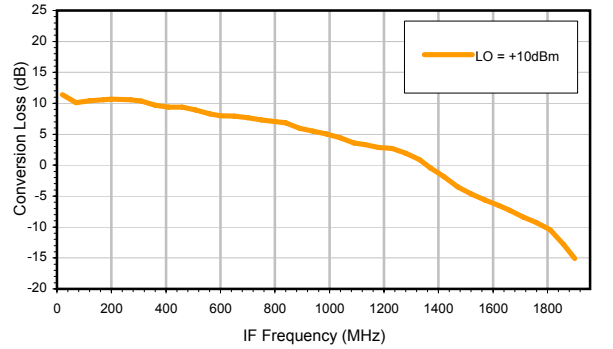

IP-3 Output

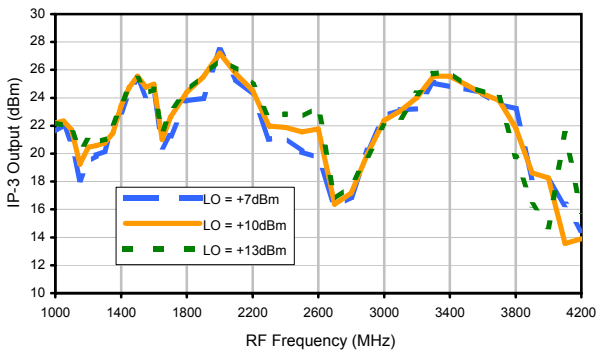

Compression @RF IN=+4 dBm

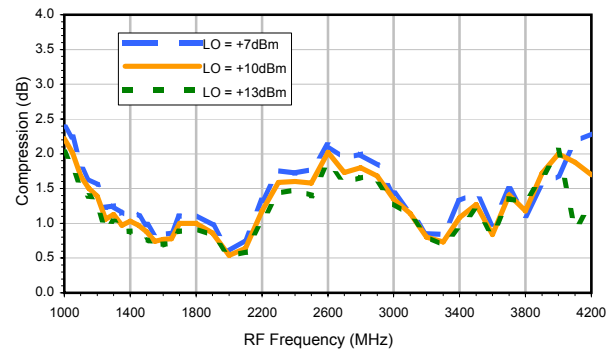

## Typical Performance Curves

### LO-RF Isolation

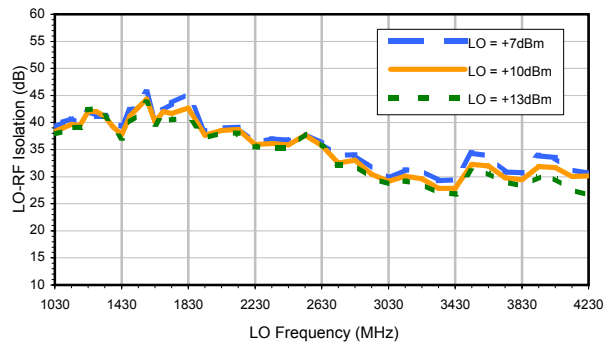

### LO-IF Isolation

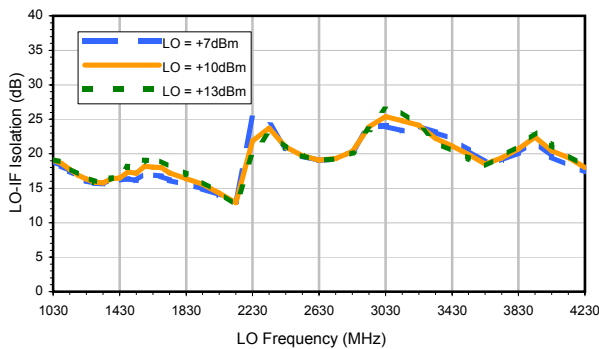

### RF-IF Isolation

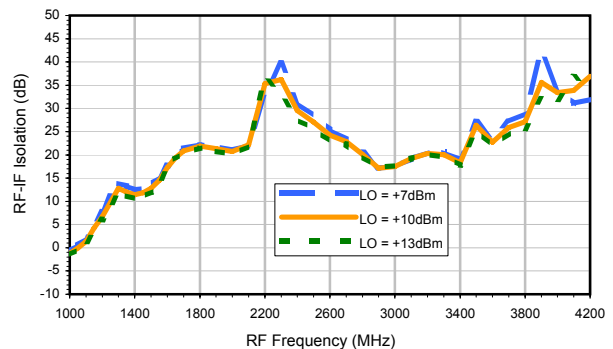

### RF VSWR

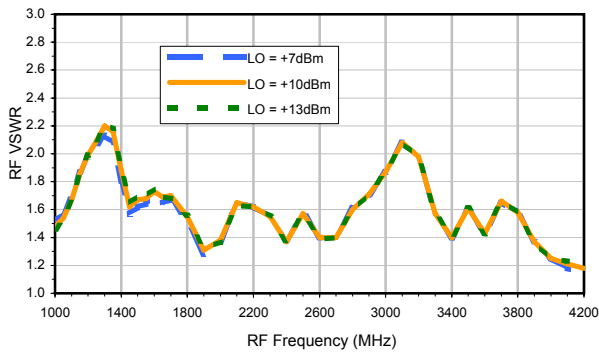

### LO VSWR

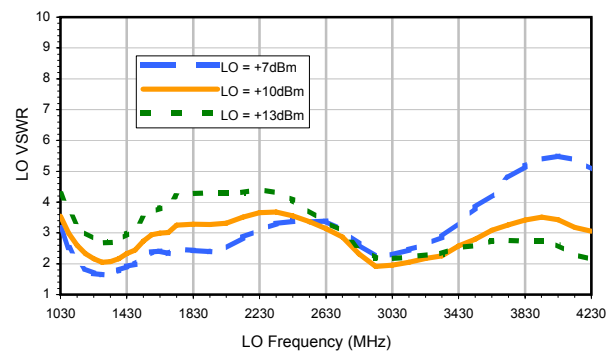

### IF VSWR

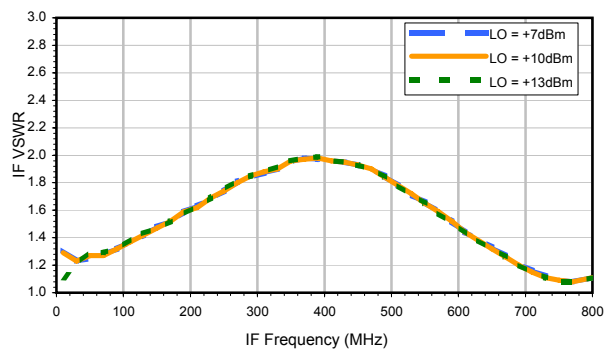

## Harmonics Tables

RF HARMONICS ORDER

	(-dBm)	(dBc)										
0	---	---	10.35	45.67	59.98	60.96	40.38	79.07	54.44	96.81	71.58	96.59
1	---	38.23	---	42.51	47.33	76.11	72.86	71.75	91.06	83.76	100.09	98.50
2	99.21	72.35	68.86	44.21	75.94	76.85	102.99	96.80	79.62	90.56	82.39	98.63
3	103.52	105.32	84.03	88.92	54.12	80.55	89.11	117.22	103.38	109.24	110.94	104.18
4	105.25	116.75	125.53	113.30	109.29	82.79	108.37	107.59	123.04	123.43	111.49	114.59
5	98.29	122.15	125.14	122.85	126.61	122.06	91.32	116.14	120.14	123.16	125.58	121.72
6	95.73	121.24	121.98	125.33	125.99	121.58	122.65	114.67	123.32	123.20	125.00	123.76
7	95.21	119.27	120.74	124.82	122.26	122.72	123.81	123.83	121.52	128.95	122.92	124.51
8	110.69	123.23	118.71	122.09	119.58	123.46	124.44	123.01	123.22	120.88	121.22	121.25
9	104.46	124.12	126.55	116.95	118.86	125.03	118.35	121.07	127.44	120.41	123.03	124.56
10	101.60	124.12	122.88	125.50	117.85	117.74	121.88	123.59	126.50	125.61	122.75	123.04
	RF CAL	0	1	2	3	4	5	6	7	8	9	10

### LO HARMONICS ORDER

Test conditions: RF IN: 2600.1 MHz; -10 dBm.  
 LO IN: 2630.1 MHz; +10.00 dBm  
 IF OUT: 30 MHz; 2.56 dBm

RF HARMONICS ORDER

	(-dBm)	(dBc)										
0	---	---	19.89	59.04	72.86	74.13	52.32	83.23	70.43	96.49	87.73	103.55
1	---	37.13	---	42.68	48.56	77.78	77.62	74.74	89.28	83.28	110.45	102.08
2	91.08	58.90	54.57	28.67	61.80	68.20	87.75	87.09	74.98	87.30	81.56	99.50
3	89.63	78.76	57.56	69.08	31.18	58.85	74.42	97.24	91.41	93.05	103.59	88.70
4	92.17	95.39	100.01	80.94	69.93	49.71	78.06	85.94	108.62	97.55	92.21	95.75
5	87.32	92.12	88.56	96.98	76.53	85.05	45.29	69.48	87.32	114.36	97.40	104.48
6	84.86	112.43	95.39	104.81	102.46	84.66	84.43	57.06	95.39	89.01	117.40	105.86
7	87.96	103.54	102.36	113.87	103.41	113.24	86.00	91.64	61.03	76.78	100.40	114.14
8	95.54	123.40	109.98	110.35	106.75	106.48	111.55	91.94	94.02	61.85	88.26	96.93
9	96.73	122.11	122.75	113.19	111.87	101.90	112.63	120.06	98.82	97.98	72.26	81.88
10	92.88	121.10	121.11	127.68	115.30	121.14	110.34	113.81	124.12	97.58	105.88	74.09
	RF CAL	0	1	2	3	4	5	6	7	8	9	10

### LO HARMONICS ORDER

Test conditions: RF IN: 2600.1 MHz; 0 dBm.  
 LO IN: 2630.1 MHz; +10.00 dBm  
 IF OUT: 30 MHz; 12.09 dBm

- Notes:
1. All Harmonics are in (dBc) relative to IF OUTPUT
  2. + entry denotes harmonics are in (dBc) above IF OUTPUT
  3. RF Cal represents the Harmonics level of the RF Input Signal to the mixer

DZ1650

## Outline Dimensions

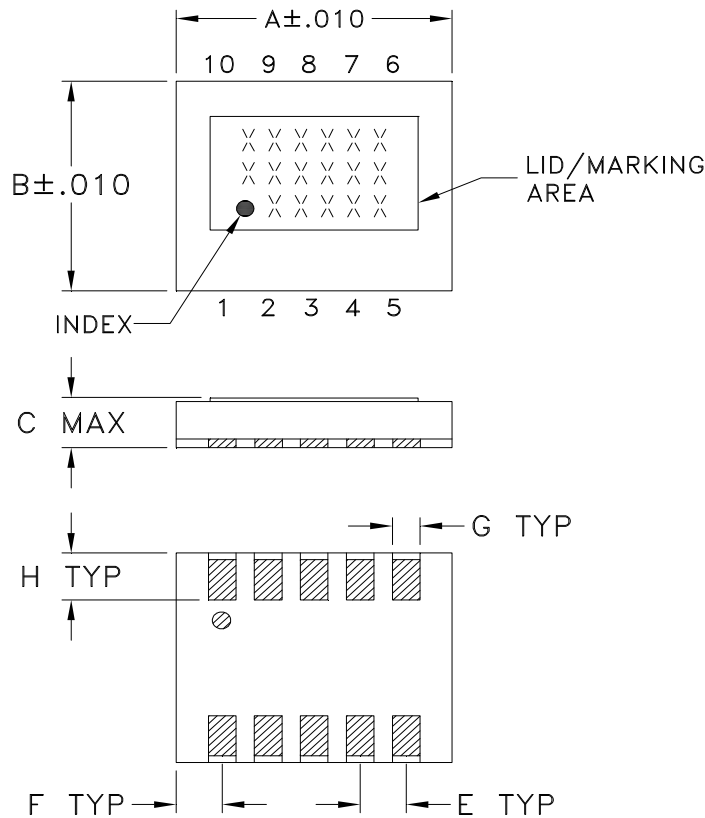

## PCB Land Pattern

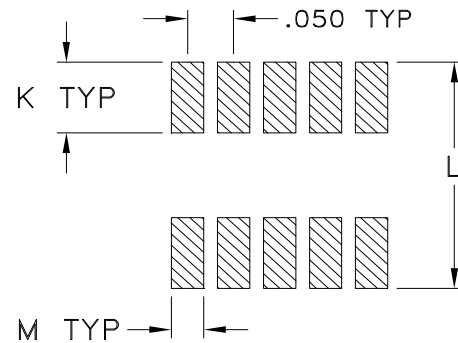

Suggested Layout,  
Tolerance to be within  $\pm .002$

CASE#	A	B	C	D	E	F	G	H	J	K	L	M	WT. GRAMS
DZ1650	.300 (7.62)	.250 (6.35)	.060 (1.52)	-- --	.050 (1.27)	.050 (1.27)	.030 (.76)	.056 (1.42)	-- --	.085 (2.16)	.270 (6.86)	.035 (.89)	.29

Dimensions are in inches (mm). Tolerances: 2Pl.  $\pm .01$ ; 3Pl.  $\pm .005$

### Notes:

- Case material: Ceramic.
- Termination finish:  
For RoHS Case Styles: 1.2  $\mu$  inch (0.03microns) Gold over 8  $\mu$  inch (0.2 microns) Palladium and 158  $\mu$  inch (4.0 microns) Nickel plate.  
All models, (+) suffix.



INTERNET <http://www.minicircuits.com>

P.O. Box 350166, Brooklyn, New York 11235-0003 (718) 934-4500 Fax (718) 332-4661

Distribution Centers NORTH AMERICA 800-654-7949 • 417-335-5935 • Fax 417-335-5945 • EUROPE 44-1252-832600 • Fax 44-1252-837010

Mini-Circuits ISO 9001 & ISO 14001 Certified

# Tape & Reel Packaging TR-F34

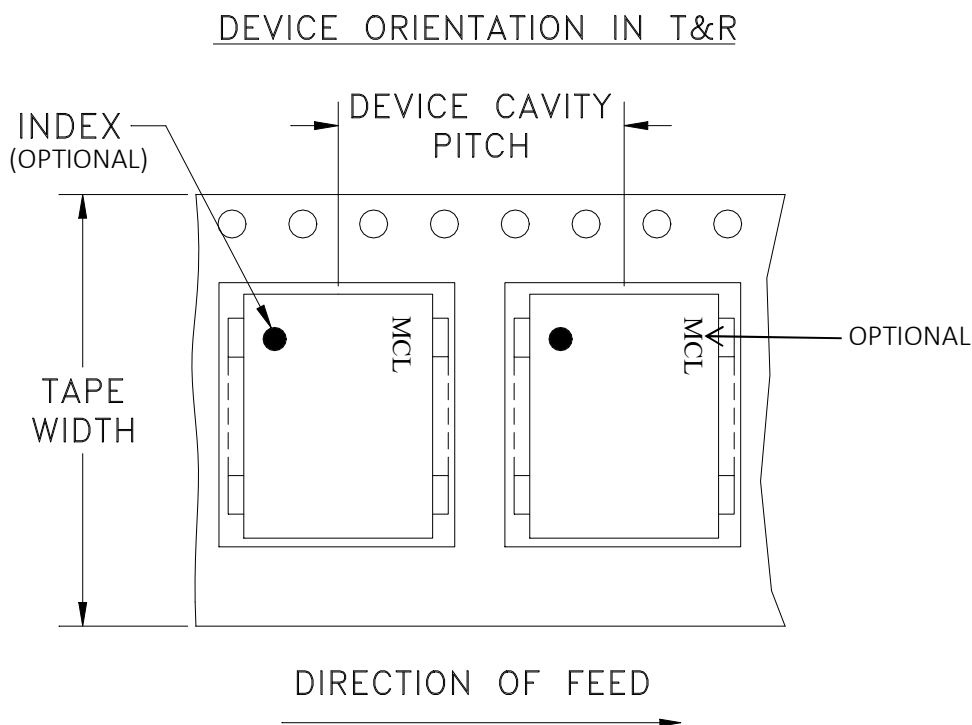

Tape Width, mm	Device Cavity Pitch, mm	Reel Size, inches	Devices per Reel see note	
16	12	7	Small quantity standard (see note)	20
				50
			Standard	100
				200
		13	Standard	500
				1000

Note: Availability of small reel quantity varies by model.  
Refer to pricing and availability on individual model dashboard.

Mini-Circuits carrier tape materials provide protection from ESD (Electro-Static Discharge) during handling and transportation. Tapes are static dissipative and comply with industry standards EIA-481/EIA-541.

Go to: [www.minicircuits.com/pages/pdfs/tape.pdf](http://www.minicircuits.com/pages/pdfs/tape.pdf)



INTERNET <http://www.minicircuits.com>

P.O. Box 350166, Brooklyn, New York 11235-0003 (718) 934-4500 Fax (718) 332-4661

Distribution Centers NORTH AMERICA 800-654-7949 • 417-335-5935 • Fax 417-335-5945 • EUROPE 44-1252-832600 • Fax 44-1252-837010

Mini-Circuits ISO 9001 & ISO 14001 Certified

THIRD ANGLE PROJECTION

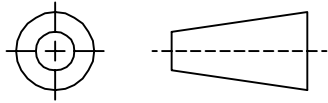

REVISIONS

REV	ECN No.	DESCRIPTION	DATE	DR	AUTH
OR	M136908	NEW RELEASE	06/12/12	GF	DJ

SUGGESTED MOUNTING CONFIGURATION  
FOR DZ1650 CASE STYLE, "10MA02" PIN CODE

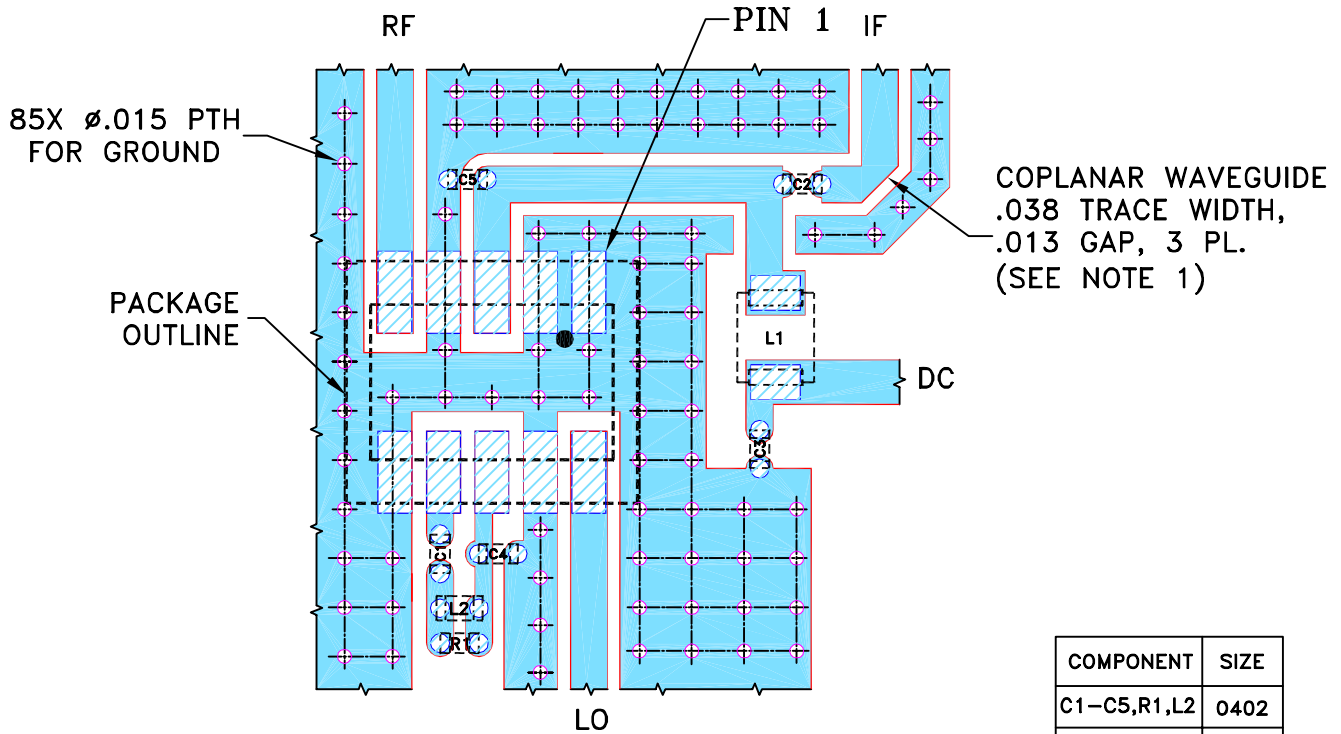

COMPONENT	SIZE
C1-C5,R1,L2	0402
L1	1008

NOTES:

1. COPLANAR WAVEGUIDE PARAMETERS ARE SHOWN FOR ROGERS R04350B WITH DIELECTRIC THICKNESS .020" ± .0015".  
COPPER: 1/2 OZ. EACH SIDE. FOR OTHER MATERIALS TRACE WIDTH AND GAP MAY NEED TO BE MODIFIED.
2. CHIP COMPONENT FOOT PRINTS SHOWN FOR REFERENCE.  
FOR COMPONENT VALUES REFER TO TB-660+.
3. BOTTOM SIDE OF THE PCB IS CONTINUOUS GROUND PLANE.

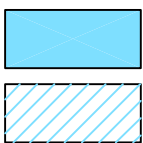

SOLID BLUE DENOTES PCB COPPER LAYOUT WITH SMOBC (SOLDER MASK OVER BARE COPPER).  
HATCHED BLUE DENOTES COPPER LAND PATTERN FREE OF SOLDER MASK.

UNLESS OTHERWISE SPECIFIED	INITIALS	DATE
DIMENSIONS ARE IN INCHES	DRAWN GF	06/08/12
TOLERANCES ON:	CHECKED AV	06/12/12
2 PL DECIMALS ±	APPROVED DJ	06/12/12
3 PL DECIMALS ± .005		
ANGLES ±		
FRACTIONS ±		

Mini-Circuits® 13 Neptune Avenue  
Brooklyn NY 11235

PL, 10MA02, DZ1650, TB-660+

SIZE	CODE IDENT	DRAWING NO:	REV:
A	15542	98-PL-369	OR
FILE:	98PL369	SCALE: 5:1	SHEET: 1 OF 1

Mini-Circuits®  
THIS DOCUMENT AND ITS CONTENTS ARE THE PROPERTY OF MINI-CIRCUITS. EXCEPT FOR USE EXPRESSLY GRANTED, IN WRITING, TO ITS VENDORS, VENDEE AND THE UNITED STATES GOVERNMENT, MINI-CIRCUITS RESERVES ALL PROPRIETARY DESIGN, USE, MANUFACTURING AND REPRODUCTION RIGHTS THERETO. THESE CONTENTS SHALL NOT BE USED, DUPLICATED OR DISCLOSED TO ANY OUTSIDE PARTY, IN WHOLE OR IN PART, WITHOUT WRITTEN PERMISSION OF MINI-CIRCUITS.

# Evaluation Board and Circuit

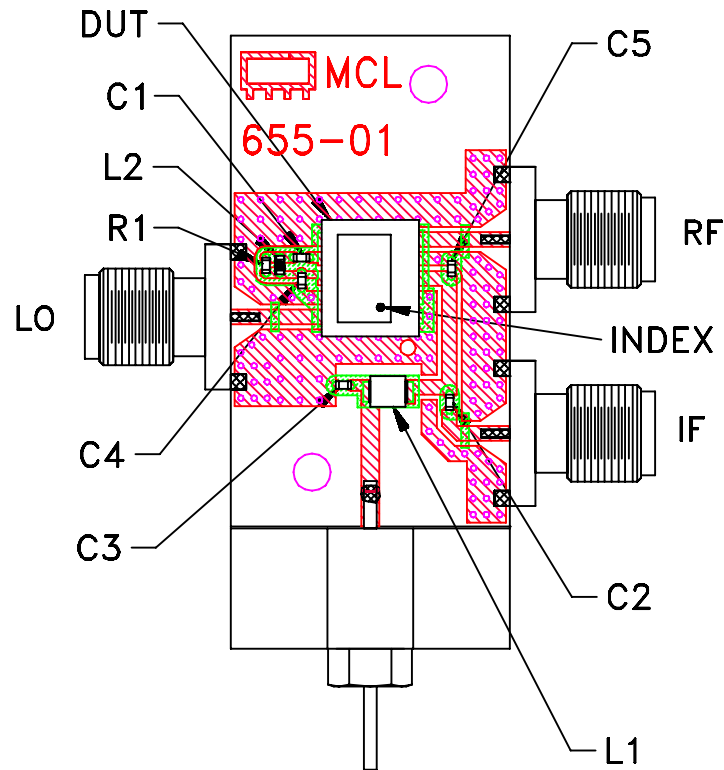

TB-660-42LH+

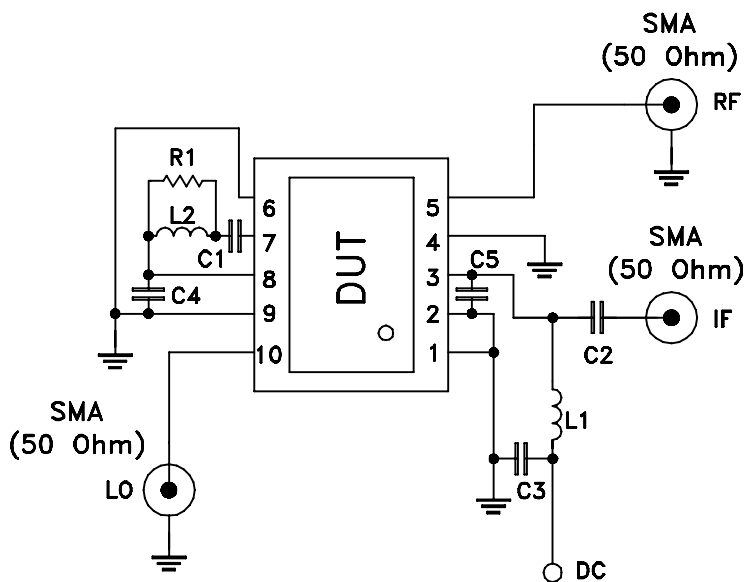

COMPONENT	VALUE
DUT	MRA-42LH+
C1,C2	0.001 $\mu$ F
C3	0.1 $\mu$ F
C4	2.0 pF
C5	1.0 pF
L1	1.5 $\mu$ H
L2	6.8 nH
R1	150 Ohm

Schematic Diagram

## Notes:

1. 50 Ohm SMA Female connectors.
2. PCB Material: R04350 or equivalent,  
Dielectric Constant=3.5, Thickness=.020 inch.

 **Mini-Circuits®**

All Mini-Circuits products are manufactured under exacting quality assurance and control standards, and are capable of meeting published specifications after being subjected to any or all of the following physical and environmental test.

Specification	Test/Inspection Condition	Reference/Spec
Operating Temperature	-55° to 125° C Ambient Environment	Individual Model Data Sheet
Storage Temperature	-65° to 150° C Ambient Environment	Individual Model Data Sheet
Thermal Shock	-55° to 100° C, 1000 cycles, 15 minutes -55° to 150° C, 1000 cycles, 15 minutes	MIL-STD-202, Method 10
HTOL	1000 hrs, 125°, at rated Lo Level	MIL-STD-202, Method 108, Condition D
High Temp Storage	150°C 1008 hours	JESD22-A103
Resistance to Solvent	Per Reference Spec	MIL-STD-202, Method 215J
Fine and Gross Leak Test	Per Reference Spec	MIL-STD-202, Method 112 Test, Conditions C, D
Constant Acceleration	Y1 plane only, 30,000 g	MIL-STD-883, Method 2001, Condition E
Mechanical Shock	Per Reference Spec	MIL-STD-202, Method 213, Condition A
Vibration (High Frequency)	20g peak, 10-2000 Hz, 12 times in each of three perpendicular directions	MIL-STD-202, Method 204, Condition D
Solderability	3X, 245° peak temp	JESD22-B102
Bend Test	1MM, deflection for 5 secs.	JESD22-B113