

Engineering Development Model

RF Transformer

NCS4-ED12817/34B25

Impedance Ratio : 4

Important Note

This model has been designed, built and tested in our engineering department. Performance data represents model capability. At present it is a non-catalog model. On request, we can supply a final specification sheet, part number and price/delivery information.



Please click "Back", and then click "Contact Us" for Applications support.

CASE STYLE: GE0805C-1

ELECTRICAL SPECIFICATIONS 50Ω @ +25°C				
Parameter	Min.	Typ.	Max.	Units
Frequency	2200		2700	MHz
Insertion Loss *	1 dB Bandwidth		2200-2700	MHz

Note: * Insertion Loss is referenced to mid-band loss, 0.7dB typ.

MAXIMUM RATINGS	
Operating Temperature	-40°C to 85°C
Storage Temperature	-55°C to 100°C
Input RF Power **	3 W

** Derate linearly to 2W at 85°C

Configuration : J

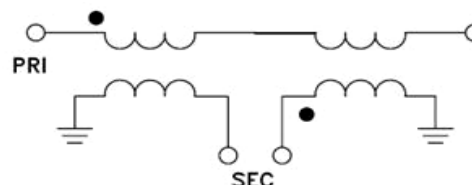

PIN CONNECTIONS	
PRIMARY DOT (Unbalanced)	1
PRIMARY (GND)	2
SECONDARY DOT (Balanced)	4
SECONDARY (Balanced)	3
NO CONNECTION	6
NOT USED (GND Externally)	5

Pads 2,3,4 are DC-connected internally.

RF Transformer

NCS4-ED12817/34B25

Typical Performance Data

FREQUENCY (MHz)	AVERAGE INSERTION LOSS* (dB)	INPUT RETURN LOSS (dB)	AMPLITUDE UNBALANCE (dB)	PHASE UNBALANCE** (deg)
1700	4.86	2.29	1.18	1.16
1750	4.25	2.64	1.07	1.05
1800	3.66	3.06	0.97	0.89
1850	3.10	3.56	0.86	0.75
1900	2.57	4.16	0.75	0.61
1950	2.07	4.89	0.66	0.53
2000	1.63	5.75	0.57	0.32
2050	1.24	6.80	0.46	0.20
2100	0.90	8.05	0.39	0.15
2150	0.62	9.59	0.31	0.09
2200	0.39	11.47	0.22	0.23
2250	0.22	13.85	0.15	0.21
2300	0.10	16.96	0.09	0.41
2350	0.03	21.04	0.04	0.38
2400	0.00	25.02	0.03	0.59
2450	0.01	23.15	0.08	0.41
2500	0.04	19.33	0.12	0.39
2550	0.09	16.48	0.17	0.47
2600	0.16	14.50	0.21	0.27
2650	0.24	12.99	0.24	0.23
2675	0.28	12.36	0.26	0.21
2700	0.33	11.81	0.28	0.08
2725	0.37	11.33	0.29	0.00
2750	0.41	10.89	0.30	0.04
2775	0.46	10.49	0.32	0.08
2800	0.50	10.13	0.33	0.14
2825	0.54	9.81	0.34	0.26
2850	0.58	9.54	0.35	0.35
2875	0.62	9.29	0.35	0.40
2900	0.67	9.05	0.36	0.42
2950	0.73	8.63	0.38	0.66
3000	0.80	8.32	0.39	0.90
3100	0.91	7.81	0.45	1.08
3200	0.99	7.46	0.43	0.89
3300	1.04	7.31	0.32	0.80
3400	1.06	7.37	0.25	1.68
3500	1.05	7.50	0.25	2.38
3600	1.01	7.66	0.16	2.59
3700	0.96	7.99	0.00	3.03
3800	0.89	8.42	0.20	3.57
3900	0.82	9.00	0.43	4.23
4000	0.74	9.67	0.68	4.89
4200	0.62	11.37	1.32	6.28
4400	0.54	13.87	2.12	8.20
4500	0.53	15.66	2.53	9.40
5000	0.97	25.57	4.92	18.31
5250	1.46	15.96	6.15	25.17
5500	2.01	12.26	7.22	32.66
5750	2.54	10.08	7.96	39.42
6000	3.10	8.47	8.33	42.32
6250	4.00	6.88	8.85	35.84

* Insertion Loss is referenced to mid-band loss , 0.7 dB.

**Phase Unbalance is relative to 180°



Distribution Centers NORTH AMERICA 800-654-7949 • 417-335-5935 • Fax 417-335-5945 • EUROPE 44-1252-832600 • Fax 44-1252-837010

Mini-Circuits ISO 9001 & ISO 14001 Certified

INTERNET <http://www.minicircuits.com>



REV. X1

NCS4-ED12817/34B25

070619

Page 1 of 1

RF Transformer

NCS4-ED12817/34B25

Typical Performance Curves



* Insertion Loss is referenced to mid-band loss , 0.7 dB.

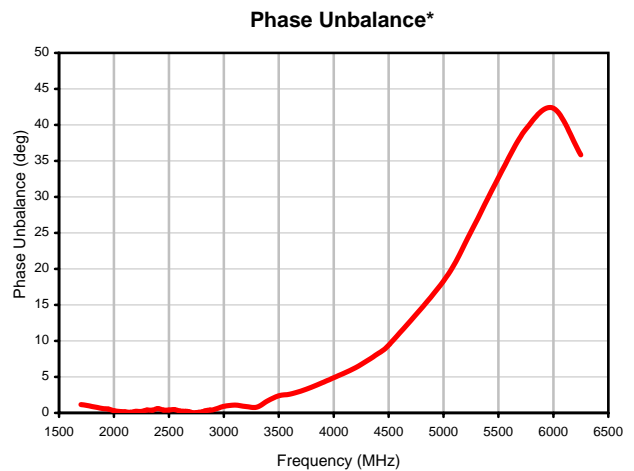
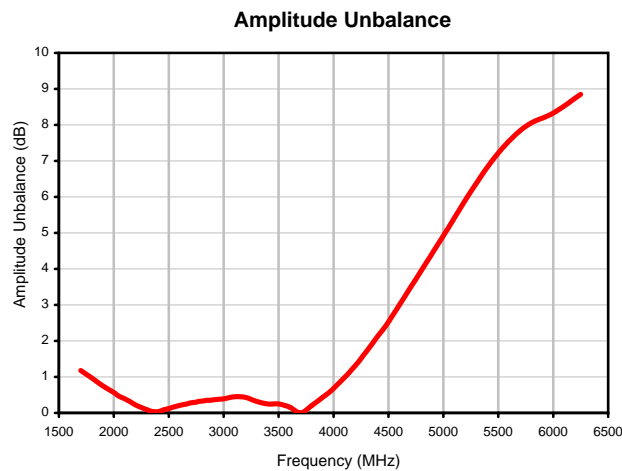
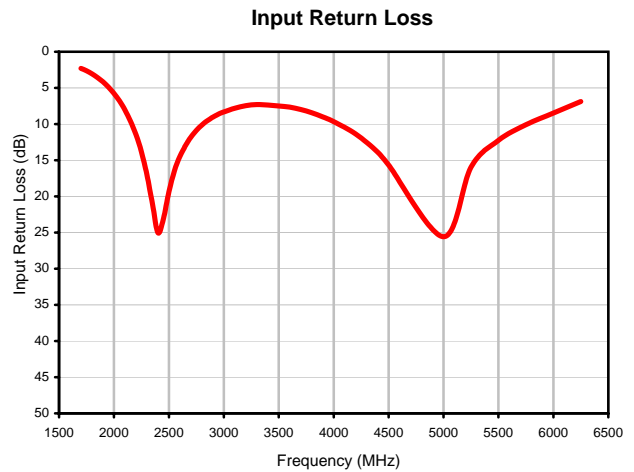

**Phase Unbalance is relative to 180°

Outline Dimensions



PCB Land Pattern



Suggested Layout,
Tolerance to be within $\pm .002$

CASE #	A	B	C	D	E	F	G	H	J	K	WT. GRAM
GE0805C-1	.079 (2.00)	.049 (1.25)	.033 (0.84)	.014 (0.35)	.012 (0.30)	.012 (0.30)	.026 (0.65)	.014 (0.35)	.039 (1.00)	.110 (2.80)	.008

Dimensions are in inches (mm). Tolerances: 2Pl. $\pm .01$; 3 Pl. $\pm .005$

Notes:

- Open style, ceramic base.
- Termination finish: For RoHS Case Styles: Tin plate over Nickel plate. All models, (+) suffix.
For RoHS-5 Case Style: Tin-lead plate. All models, no (+) suffix.



P.O. Box 350166, Brooklyn, New York 11235-0003 (718) 934-4500 Fax (718) 332-4661 For detailed performance specs & shopping online see Mini-Circuits web site



The Design Engineers Search Engine Provides ACTUAL Data Instantly From MINI-CIRCUITS At: www.minicircuits.com

RF/IF MICROWAVE COMPONENTS

Tape & Reel Packaging TR-F74

DEVICE ORIENTATION IN T&R

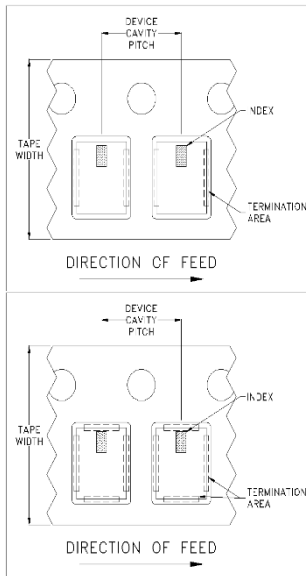

ILLUSTRATION 1

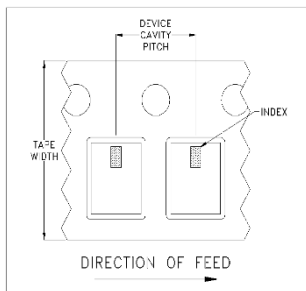

ILLUSTRATION 2

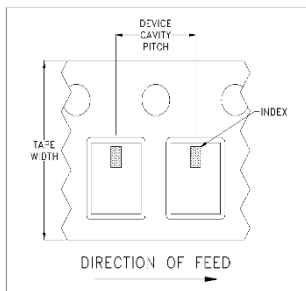

ILLUSTRATION 3

Applicable Case Styles

GE0805C-1
 GE0805C-1AP
 JV1210C-1
 GU2939

Applicable Case Styles

JV1210C
 JV1210C-2
 JV1210C-3
 JV1210C-4
 JV1210C-5
 JV1210C-6
 JV1210C-11

Applicable Case Styles

JC0603C-8
 JC0603C-9
 JV1210C-7
 JV1210C-8
 JV1210C-9
 JV1210C-10
 JV1210C-13
 GE0805C-13
 GE0805C-19
 GE0805C-20

Tape Width, mm	Device Cavity Pitch, mm	Real Size, inches	Devices per Reel	
8	4	7	Small quantity standards (see note)	20
				50
				100
				200
				500
				1000
			Standard	2000
				4000

Note: Small reel availability varies by model. Refer to pricing and availability on individual model dashboard.

Mini-Circuits carrier tape materials provide protection from ESD (Electro-Static Discharge) during handling and transportation. Tapes are static dissipative and comply with industry standards EIA-481/EIA-541.

Go to: www.minicircuits.com/pages/pdfs/tape.pdf



Distribution Centers NORTH AMERICA 800-654-7949 • 417-335-5935 • Fax 417-335-5945 • EUROPE 44-1252-832600 • Fax 44-1252-837010

Mini-Circuits ISO 9001 & ISO 14001 Certified

INTERNET <http://www.minicircuits.com>

P.O. Box 350166, Brooklyn, New York 11235-0003 (718) 934-4500 Fax (718) 332-4661

THIRD ANGLE PROJECTION



REVISIONS

REV	ECN No.	DESCRIPTION	DATE	DR	AUTH
OR	M109549	NEW RELEASE	01/31/07	PW	DJ

SUGGESTED MOUNTING CONFIGURATION
FOR GE0805C-1 CASE STYLE, "ry" PIN CONNECTION.

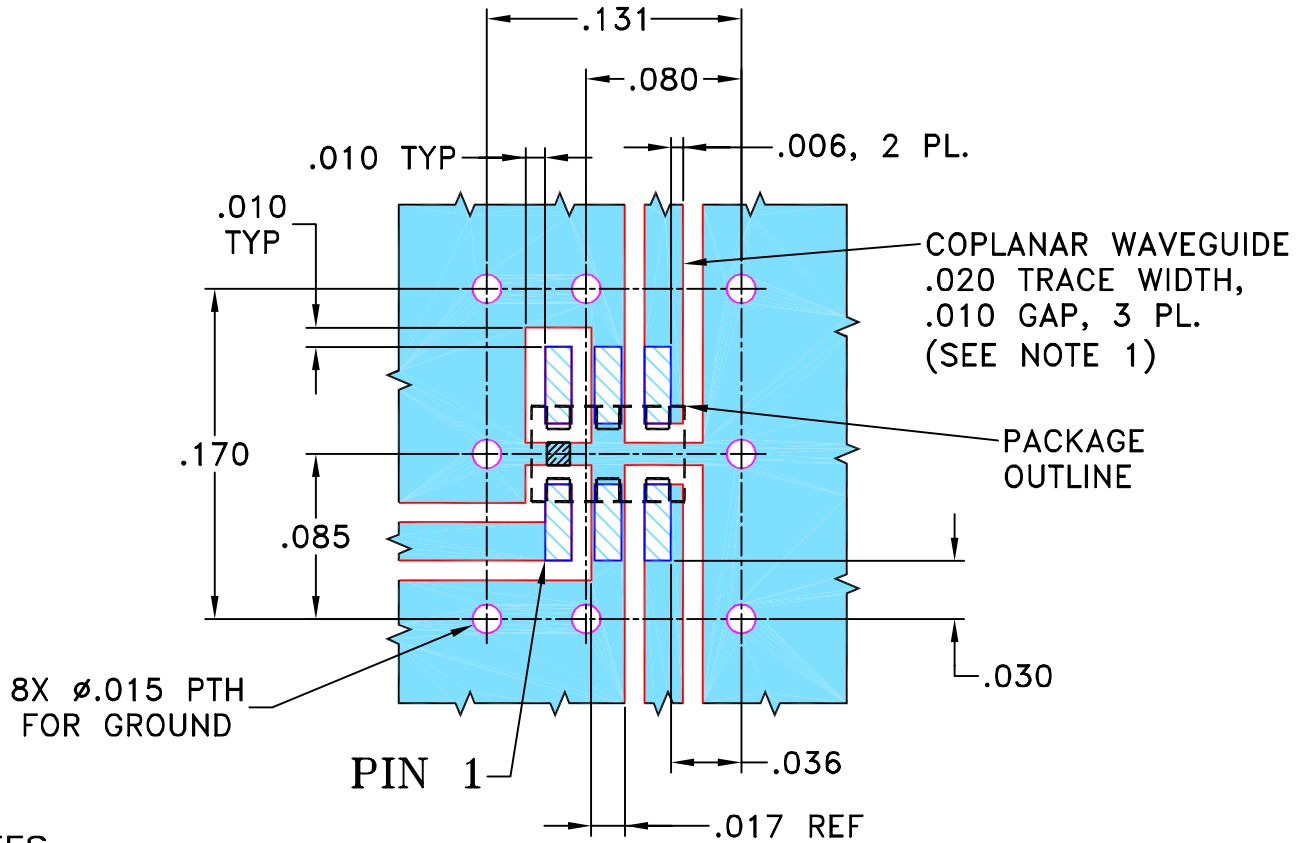

NOTES:

1. COPLANAR WAVEGUIDE PARAMETERS ARE SHOWN FOR ROGERS R04350B WITH DIELECTRIC THICKNESS .010" ± .001". COPPER: 1/2 OZ. EACH SIDE. FOR OTHER MATERIALS TRACE WIDTH AND GAP MAY NEED TO BE MODIFIED.
2. BOTTOM SIDE OF THE PCB IS CONTINUOUS GROUND PLANE.



DENOTES PCB COPPER LAYOUT WITH SMOBC (SOLDER MASK OVER BARE COPPER).

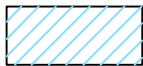

DENOTES COPPER LAND PATTERN FREE OF SOLDER MASK

UNLESS OTHERWISE SPECIFIED	INITIALS		DATE
DIMENSIONS ARE IN INCHES TOLERANCES ON: 2 PL DECIMALS ± 3 PL DECIMALS ± .005 ANGLES ± FRACTIONS ±	DRAWN	PW	01/30/07
	CHECKED	IL	01/31/07
	APPROVED	DJ	01/31/07



Mini-Circuits®

13 Neptune Avenue
Brooklyn NY 11235

PL, ry, GE0805C-1, NCS, TB-419+

Mini-Circuits®
 THIS DOCUMENT AND ITS CONTENTS ARE THE PROPERTY OF MINI-CIRCUITS. EXCEPT FOR USE EXPRESSLY GRANTED, IN WRITING, TO ITS VENDORS, VENDEE AND THE UNITED STATES GOVERNMENT, MINI-CIRCUITS RESERVES ALL PROPRIETARY DESIGN, USE, MANUFACTURING AND REPRODUCTION RIGHTS THERETO. THESE CONTENTS SHALL NOT BE USED, DUPLICATED OR DISCLOSED TO ANY OUTSIDE PARTY, IN WHOLE OR IN PART, WITHOUT WRITTEN PERMISSION OF MINI-CIRCUITS.

SIZE A	CODE IDENT 15542	DRAWING NO: 98-PL-264	REV: OR
FILE: 98PL264	SCALE: 10:1	SHEET: 1 OF 1	

Evaluation Board and Circuit

For Pin Connections refer to Data Sheet of the DUT

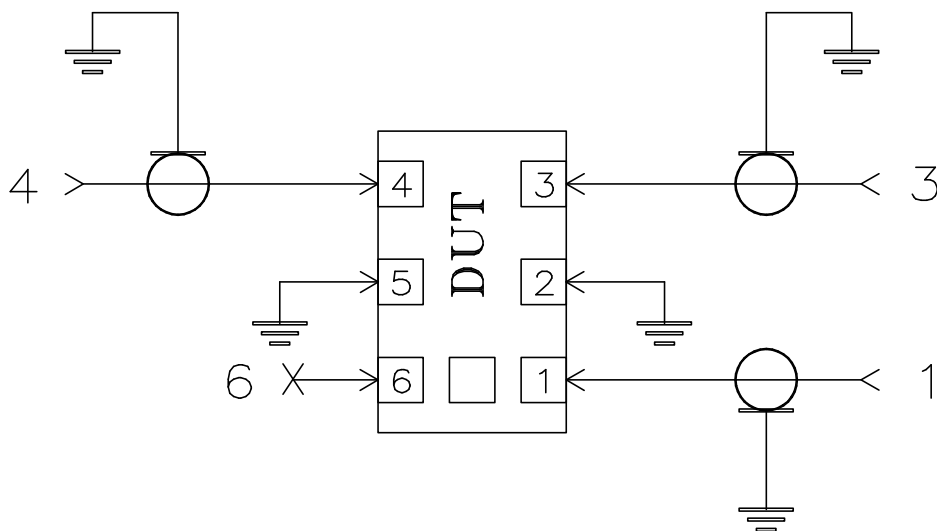
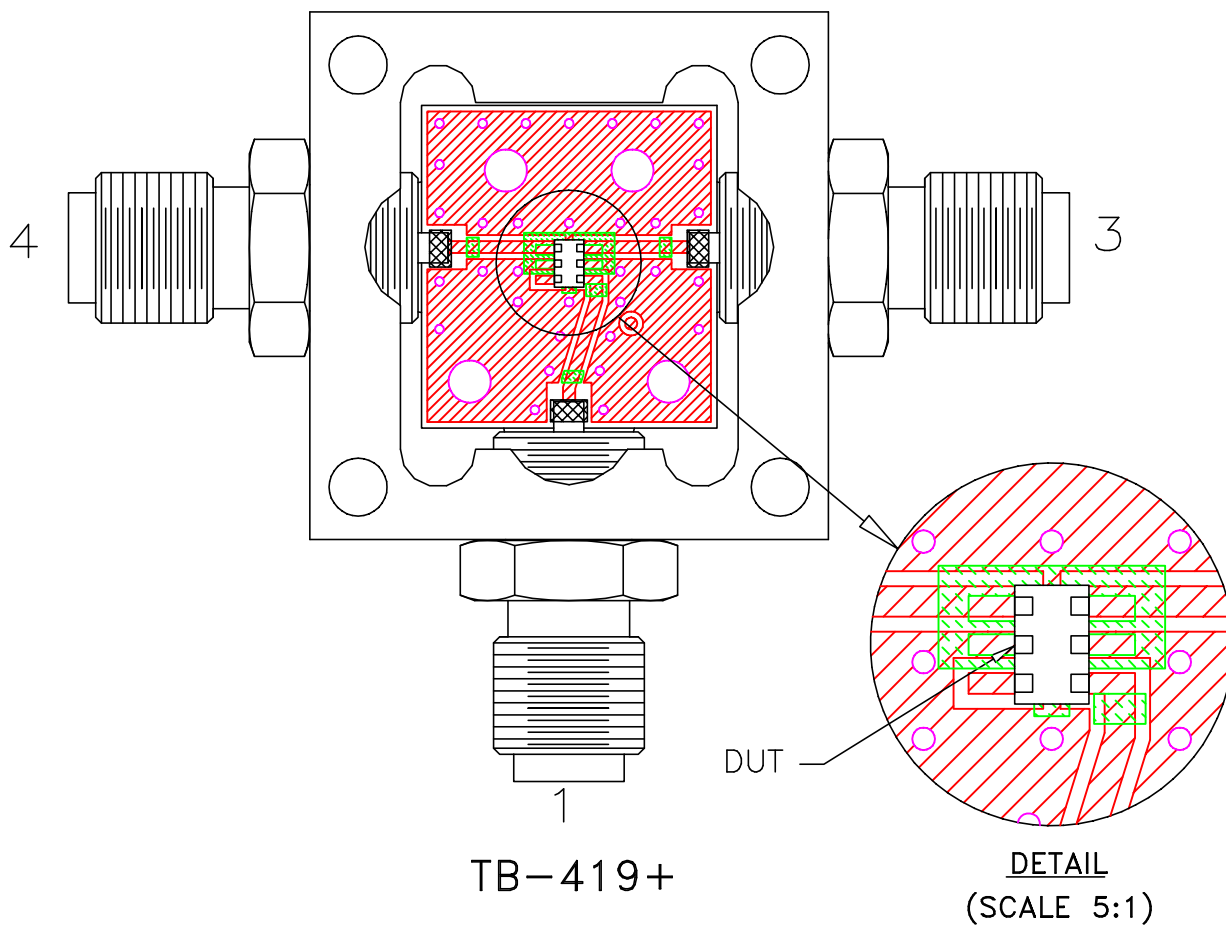

Schematic Diagram

Notes:

1. SMA Female connectors.
2. PCB Material: Rogers R04350 or equivalent, Dielectric Constant=3.5, Thickness=.010 inch.

 **Mini-Circuits®**

All Mini-Circuits products are manufactured under exacting quality assurance and control standards, and are capable of meeting published specifications after being subjected to any or all of the following physical and environmental test.

Specification	Test/Inspection Condition	Reference/Spec
Operating Temperature	-40° to 85° C Ambient Environment	Individual Model Data Sheet
Storage Temperature	-55° to 100° C Ambient Environment	Individual Model Data Sheet
Humidity	90 to 95% RH, 240 hours, 50°C	MIL-STD-202, Method 103, Condition A, Except 50°C and end-point electrical test done within 12 hours
Thermal Shock	-55° to 100°C, 100 cycles	MIL-STD-202, Method 107, Condition A-3, except +100°C
Solder Reflow Heat	Sn-Pb Eutetic Process: 225°C peak Pb-Free Process 245° - 250°C peak	J-STD-020, Table 4-1, 4-2 and 5-2, Figure 5-1
Solderability	10X Magnification	J-STD-002, Para 4.2.5, Test S, 95% Coverage
Vibration (High Frequency)	20g peak, 10-2000 Hz, 12 times in each of three perpendicular directions (total 36)	MIL-STD-202, Method 204, Condition D
Mechanical Shock	50g, 11 ms, 1/2-sine, 18 shocks: 3 each direction, each of 3 axes	MIL-STD-202, Method 213, Condition A