

# Low Pass Filter

## NLP-450+

50Ω DC to 400 MHz

### Maximum Ratings

Operating Temperature	-55°C to 100°C
Storage Temperature	-55°C to 100°C
RF Power Input	0.5W max.

Permanent damage may occur if any of these limits are exceeded.

### Features

- rugged shielded case
- other NLP models available with wide selection of cut-off frequencies

### Applications

- lab use
- test equipment
- video equipment



Generic photo used for illustration purposes only

CASE STYLE: FF57

Connectors Model

N-Type NLP-450+

**+RoHS Compliant**

The +Suffix identifies RoHS Compliance. See our web site for RoHS Compliance methodologies and qualifications

### Low Pass Filter Electrical Specifications

PASSBAND (MHz)	fco (MHz) Nom.	STOPBAND (MHz)		VSWR (:1)	
		(loss > 20 dB)	(loss > 40 dB)	Passband Typ.	Stopband Typ.
DC-400	440	580-750	750-1800	1.7	18

### Outline Drawing

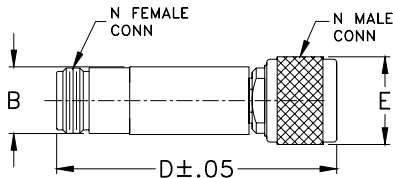

### Outline Dimensions (inch/mm)

B	D	E	wt
.67	2.90	.82	grams
17.02	73.66	20.83	90.0

### typical frequency response

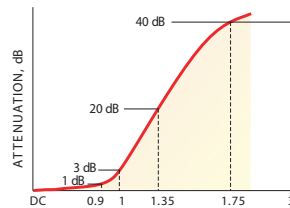

### electrical schematic

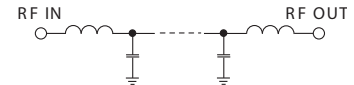

### typical Performance Data

Frequency (MHz)	Return Loss (dB)	Frequency (MHz)	Group Delay (nsec)
10.00	42.4	10.00	1.96
80.00	33.6	80.00	2.10
147.50	28.3	147.50	2.16
217.50	21.0	217.50	2.27
285.00	21.4	285.00	2.60
355.00	16.3	355.00	3.25
400.00	18.0	400.00	4.26
420.00	12.8	410.00	4.76
440.00	5.2	420.00	5.32
545.00	0.4	430.00	5.87
555.00	0.3	440.00	5.99
565.00	0.3	545.00	1.52
570.00	0.3	550.00	1.28
575.00	0.3	555.00	1.45
580.00	0.3	560.00	1.42
590.00	0.3	565.00	1.12
620.00	0.2	570.00	0.88
680.00	0.2	575.00	1.20
700.00	0.1	580.00	1.11
720.06	0.1	590.00	1.48
750.00	0.2	600.00	1.67
975.00	0.1	620.00	0.93
1112.50	0.1	640.00	1.24
1250.00	0.1	680.00	0.64
1387.50	0.1	700.00	0.62
1525.00	0.1	720.00	0.59
1592.50	0.1	750.00	0.58
1662.50	0.1	975.00	0.56
1730.00	0.1	1042.50	0.53
1800.00	0.1	1112.50	0.52

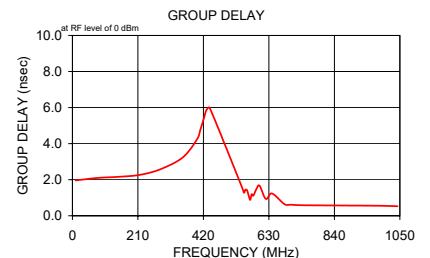
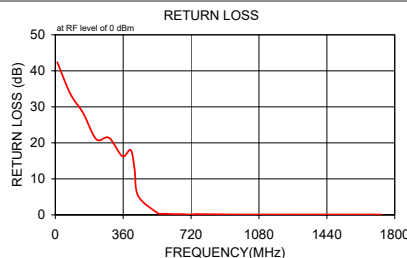

### Notes

- Performance and quality attributes and conditions not expressly stated in this specification document are intended to be excluded and do not form a part of this specification document.
- Electrical specifications and performance data contained in this specification document are based on Mini-Circuit's applicable established test performance criteria and measurement instructions.
- The parts covered by this specification document are subject to Mini-Circuits standard limited warranty and terms and conditions (collectively, "Standard Terms"); Purchasers of this part are entitled to the rights and benefits contained therein. For a full statement of the Standard Terms and the exclusive rights and remedies thereunder, please visit Mini-Circuits' website at [www.minicircuits.com/MCLStore/terms.jsp](http://www.minicircuits.com/MCLStore/terms.jsp)



# Coaxial Low Pass Filter

# NLP-450+

## Typical Performance Data

FREQUENCY (MHz)	INSERTION LOSS (dB)	RETURN LOSS (dB)	FREQUENCY (MHz)	GROUP DELAY (nsec)
10.0	0.13	40.83	10.0	2.360
50.0	0.14	27.08	50.0	2.110
100.0	0.15	25.01	100.0	2.160
150.0	0.18	34.08	150.0	2.240
200.0	0.24	24.19	200.0	2.330
250.0	0.32	19.30	250.0	2.470
300.0	0.36	19.79	300.0	2.720
350.0	0.44	21.77	350.0	3.140
400.0	0.64	18.07	400.0	4.280
420.0	1.28	9.50	420.0	4.990
430.0	2.04	6.51	430.0	5.170
440.0	3.18	4.35	440.0	5.040
450.0	4.74	2.92	450.0	4.620
460.0	6.56	1.97	460.0	4.100
470.0	8.55	1.38	470.0	3.550
480.0	10.59	1.03	480.0	3.070
490.0	12.64	0.81	490.0	2.660
500.0	14.63	0.68	500.0	2.320
510.0	16.57	0.60	520.0	1.860
520.0	18.44	0.54	530.0	1.690
530.0	20.24	0.49	535.0	1.620
535.0	21.12	0.46	540.0	1.560
540.0	21.98	0.44	550.0	1.440
550.0	23.65	0.40	600.0	1.040
600.0	31.39	0.34	650.0	0.830
650.0	38.10	0.28	665.0	0.810
665.0	39.97	0.28	666.0	0.790
670.0	40.59	0.28	669.0	0.780
1000.0	71.12	0.19	670.0	0.750
1500.0	84.02	0.24	1000.0	0.510
2000.0	83.85	0.34	1500.0	0.390
2500.0	99.38	0.35	2000.0	0.250
3000.0	75.40	0.37	3000.0	0.160

REV. X1  
NLP-450+  
070603  
Page 1 of 1



IF/RF MICROWAVE COMPONENTS • ISO 9001 ISO 14001 AS 9100 CERTIFIED • RoHS compliant  
P.O. Box 350166, Brooklyn, New York 11235-0003 (718) 934-4500 Fax (718) 332-4661



The Design Engineers Search Engine finds the model you need, Instantly • For detailed performance specs & shopping online see



## Typical Performance Curves

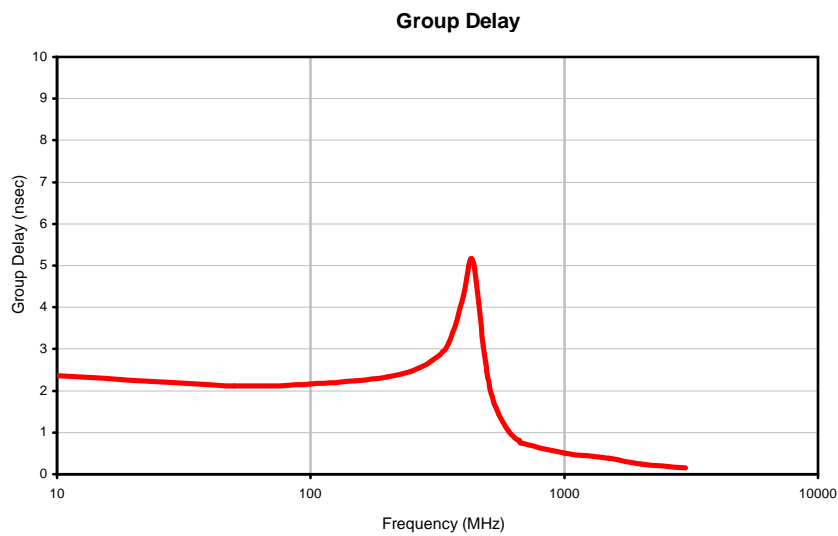
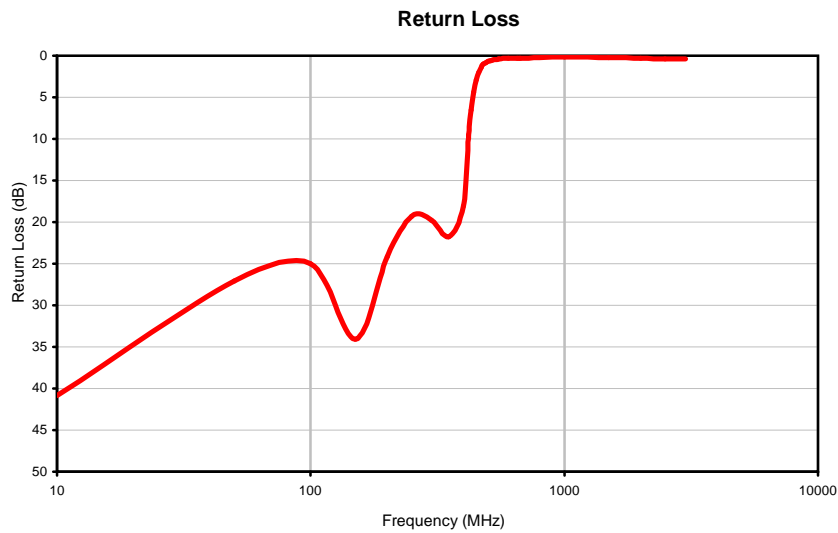
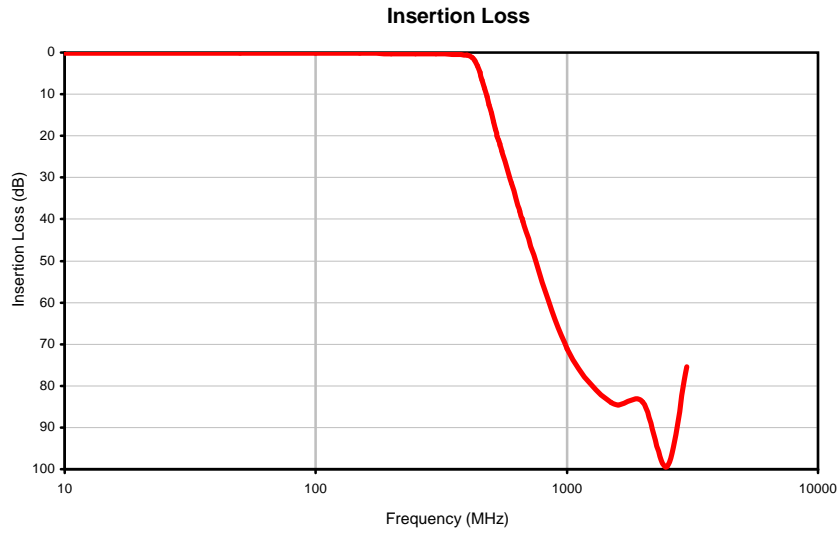

IF/RF MICROWAVE COMPONENTS • ISO 9001 ISO 14001 AS 9100 CERTIFIED RoHS compliant  
P.O. Box 350166, Brooklyn, New York 11235-0003 (718) 934-4500 Fax (718) 332-4661



The Design Engineers Search Engine finds the model you need, Instantly • For detailed performance specs & shopping online see



### Outline Dimensions

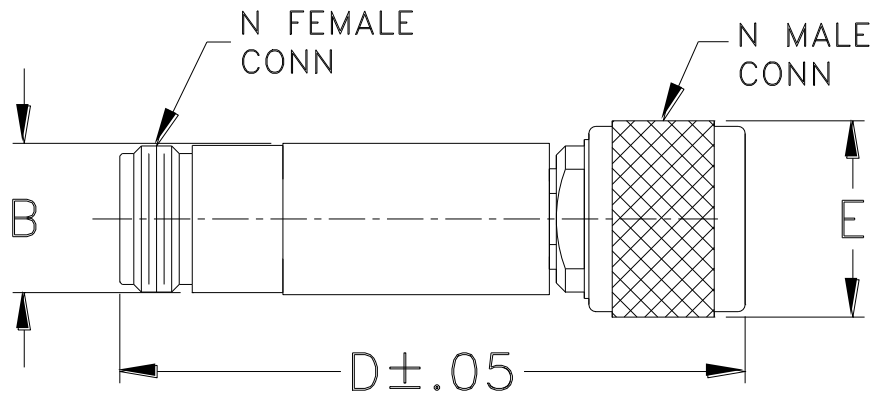

CASE #.	A	B	C	D	E	WT GRAMS
FF57	--	.70 (17.78)	--	2.90 (73.66)	.82 (20.83)	90.0

Dimensions are in inches (mm). Tolerances: 2Pl. ± .03; 3Pl. ± .015

#### Note:

1. Case material: Stainless steel.



All Mini-Circuits products are manufactured under exacting quality assurance and control standards, and are capable of meeting published specifications after being subjected to any or all of the following physical and environmental test.

<b>Specification</b>	<b>Test/Inspection Condition</b>	<b>Reference/Spec</b>
Operating Temperature	-55° to 100°C Ambient Environment	Individual Model Data Sheet
Storage Temperature	-55° to 100° C Ambient Environment	Individual Model Data Sheet
Barometric Pressure	100,000 Feet	MIL-STD-202, Method 105, Condition D
Humidity	90% RH, 65°C Units may require bake-out after humidity to restore full performance.	MIL-STD-202, Method 103
Thermal Shock	-65° to 125°C, 5 cycles	MIL-STD-202, Method 107, Condition B
Vibration (High Frequency)	20g peak, 10-2000 Hz, 12 times in each of three perpendicular directions (total 36)	MIL-STD-202, Method 204, Condition D
Mechanical Shock	100g, 6ms sawtooth, 3 shocks each direction 3 axes (total 18)	MIL-STD-202, Method 213, Condition I