

**FEATURES**

- Wideband, DC to 7 GHz
- Excellent VSWR Through Entire Band
- Miniature Size
- Aqueous Washable

APPLICATIONS

- Power Leveling
- Impedance Match Improvement

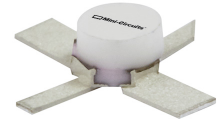

Generic photo used for illustration purposes only

CASE STYLE: AF320

+RoHS CompliantThe +Suffix identifies RoHS Compliance.
See our website for methodologies and qualifications**ELECTRICAL SPECIFICATIONS AT +25°C**

Parameter	Condition (GHz)	Min.	Typ.	Max.	Unit
Frequency Range		DC		7	GHz
Attenuation, Nominal			2±0.2		dB
Attenuation, Flatness ¹	DC - 1			0.3	dB
	DC - 2.5			0.5	
	DC - 7			0.9	
VSWR	DC - 1			1.2	:1
	DC - 2.5			1.3	
	DC - 7			1.5	
Input Power ²				1.0	W

1. Flatness = variation over band divided by 2.

2. RF power at +25°C case temperature: 1 Watt. Derate linearly to 0.1 Watt at +100°C.

ABSOLUTE MAXIMUM RATINGS

Parameter	Ratings
Operating Temperature	-55°C to +100°C
Storage Temperature	-55°C to +100°C

Permanent damage may occur if any of these limits are exceeded.



MINIATURE CERAMIC

Fixed Attenuator

PAT-2+

Mini-Circuits

50Ω 1 W 2 dB DC to 7 GHz

PIN CONNECTIONS

INPUT	1
OUTPUT	3
GROUND	2,4

DEMO BOARD MCL P/N: TB-319 SUGGESTED PCB LAYOUT (PL-208)

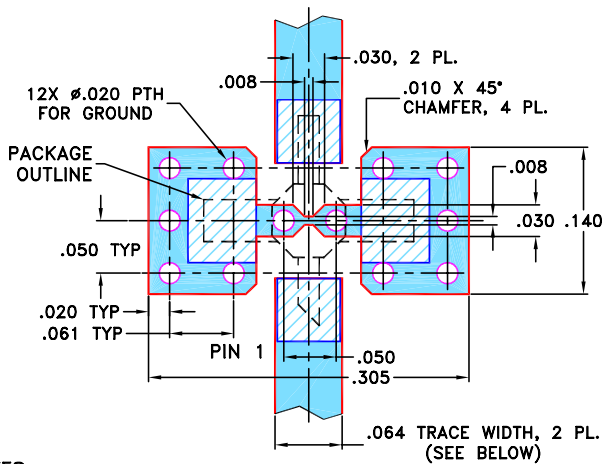

NOTES:

- TRACE WIDTH IS SHOWN FOR ROGERS RO4350B WITH DIELECTRIC THICKNESS .030" ± .002"; COPPER: 1/2 OZ. EACH SIDE. FOR OTHER MATERIALS TRACE WIDTH MAY NEED TO BE MODIFIED.
- BOTTOM SIDE OF THE PCB IS CONTINUOUS GROUND PLANE.

- DENOTES PCB COPPER LAYOUT WITH SMOBC (SOLDER MASK OVER BARE COPPER)
- DENOTES COPPER LAND PATTERN FREE OF SOLDER MASK

PRODUCT MARKING

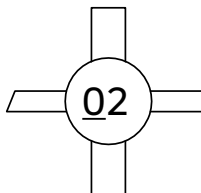

Marking may contain other features or characters for internal lot control

OUTLINE DRAWING

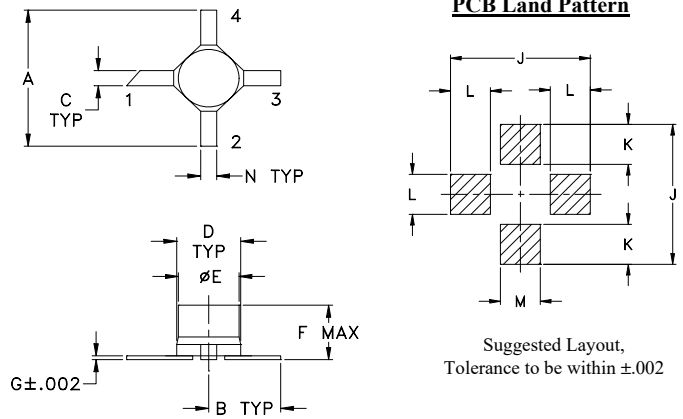

OUTLINE DIMENSIONS (Inch mm)

A	B	C	D	E	F	G
.200	.100	.020	.070	.068	.057	.005
5.08	2.54	0.51	1.78	1.73	1.45	0.13
H	J	K	L	M	N	wt
--	.230	.065	.060	.080	.040	grams
--	5.84	1.65	1.52	2.03	1.02	0.04

TAPE & REEL INFORMATION: F26



MINIATURE CERAMIC

Fixed Attenuator

PAT-2+

50Ω 1 W 2 dB DC to 2.5 GHz

TYPICAL PERFORMANCE DATA AND CHARTS

Frequency (MHz)	Attenuation (dB)	VSWR (:1)
50.00	1.94	1.05
796.25	2.21	1.07
1542.50	2.30	1.05
2288.75	2.36	1.01
3035.00	2.60	1.06
3781.25	2.43	1.08
4527.50	2.50	1.09
5273.75	2.53	1.09
6020.00	2.65	1.07
7015.00	2.91	1.16

PAT-2+ ATTENUATION

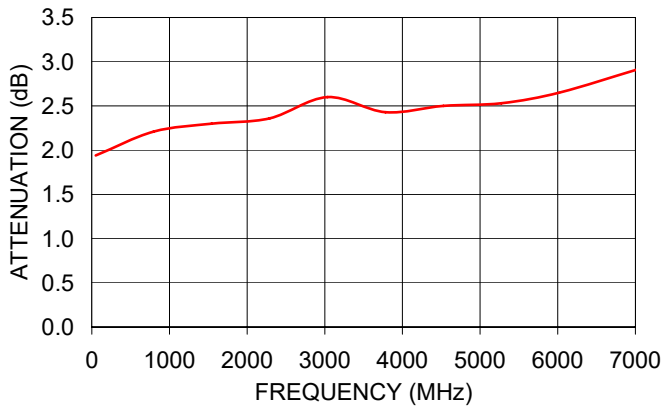

PAT-2+ VSWR

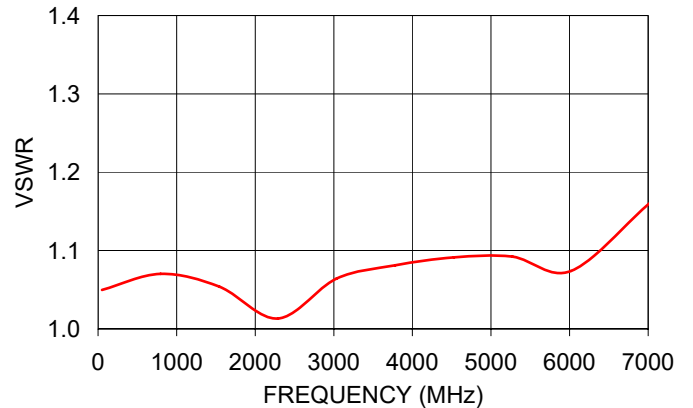

NOTES

- A. Performance and quality attributes and conditions not expressly stated in this specification document are intended to be excluded and do not form a part of this specification document.
- B. Electrical specifications and performance data contained in this specification document are based on Mini-Circuits' applicable established test performance criteria and measurement instructions.
- C. The parts covered by this specification document are subject to Mini-Circuits' standard limited warranty and terms and conditions (collectively, "Standard Terms"); Purchasers of this part are entitled to the rights and benefits contained therein. For a full statement of the standard terms and the exclusive rights and remedies thereunder, please visit Mini-Circuits' website at www.minicircuits.com/terms/viewterm.html



Typical Performance Data

FREQUENCY (MHz)	ATTENUATION (dB)	RETURN LOSS (dB)
50.00	1.94	32.32
796.25	2.21	29.39
1542.50	2.30	31.62
2288.75	2.36	43.65
3035.00	2.60	30.14
3781.25	2.43	28.18
4527.50	2.50	27.21
5273.75	2.53	27.11
6020.00	2.65	28.95
7015.00	2.91	22.60

REV. X1
PAT-2+
061108
Page 1 of 1



IF/RF MICROWAVE COMPONENTS • ISO 9001 ISO 14001 AS 9100 CERTIFIED RoHS compliant
P.O. Box 350166, Brooklyn, New York 11235-0003 (718) 934-4500 Fax (718) 332-4661



The Design Engineers Search Engine finds the model you need, Instantly • For detailed performance specs & shopping online see



Typical Performance Curves

Attenuation

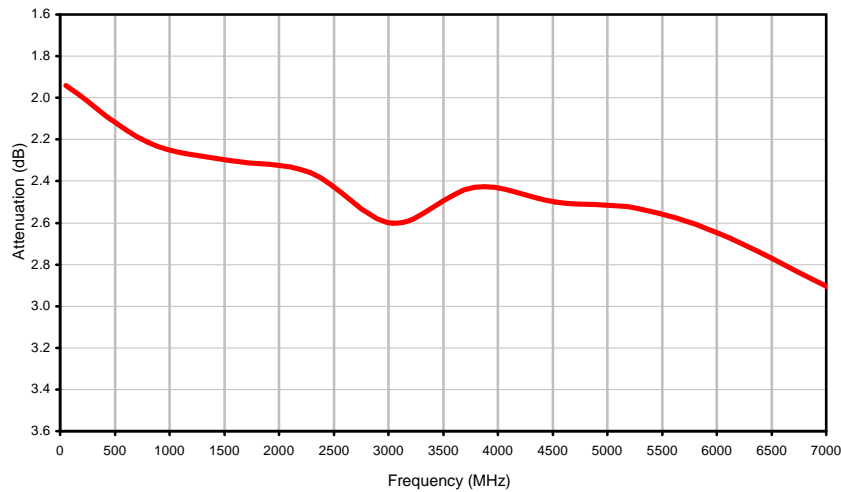

Return Loss

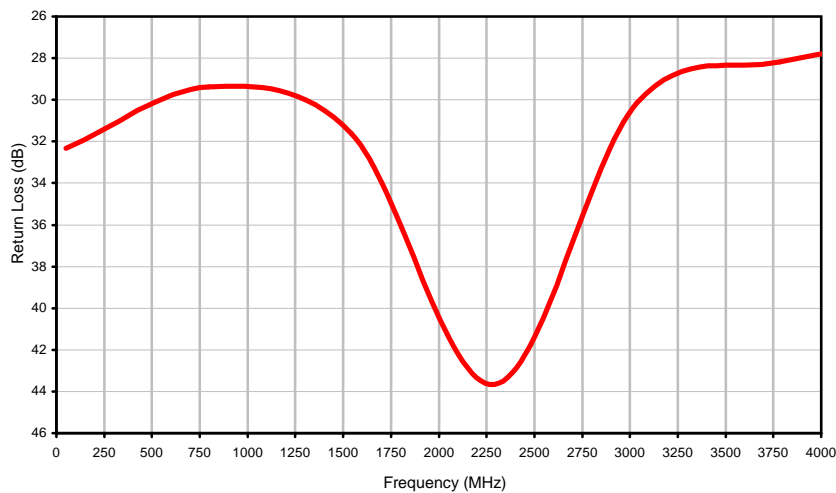

Outline Dimensions

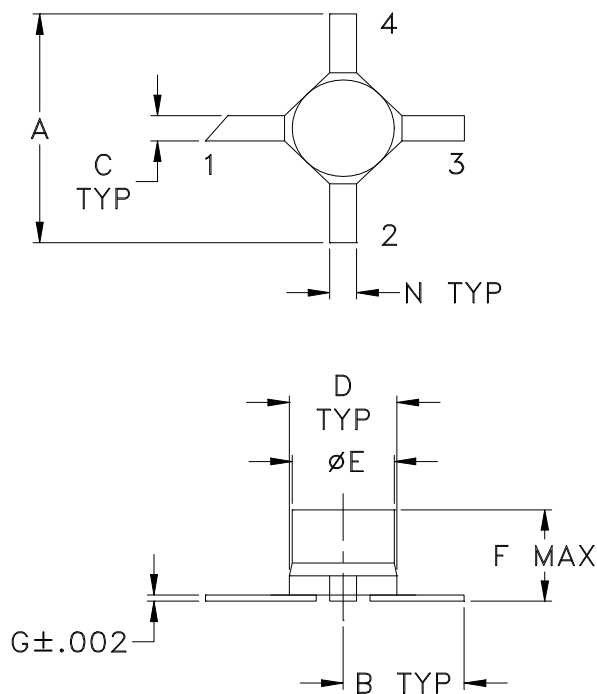

PCB Land Pattern

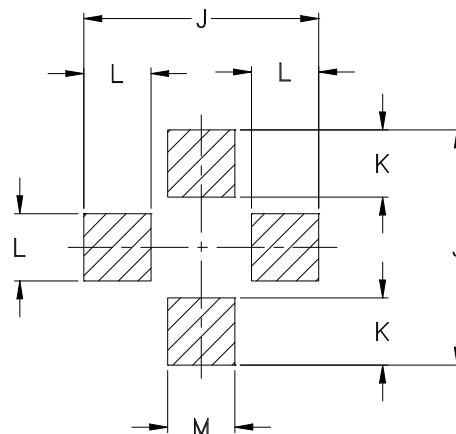

Suggested Layout,
Tolerance to be within $\pm .002$

CASE #	A	B	C	D	E	F	G	H	J	K	L	M	N	WT. GRAM
AF320	.200 (5.08)	.100 (2.54)	.020 (0.51)	.070 (1.78)	.068 (1.73)	.057 (1.45)	.005 (0.13)	-	.230 (5.84)	.065 (1.65)	.060 (1.52)	.080 (2.03)	.040 (1.02)	.04

Dimensions are in inches (mm). Tolerances: 2Pl. $\pm .03$; 3Pl. $\pm .015$

Notes:

- Case material: Ceramic.
- Termination material:
Nickel-Iron alloy 42.
- Termination finish:
For RoHS Case Styles: Tin-Silver alloy plate over Nickel barrier or Matte-Tin. (See Data Sheet)
For RoHS-5 Case Styles: Tin-Lead plate.
- Termination (1):
May have diagonal cut. Input and output interchangeable for PAT models only.
- Special Tolerances: Termination width $\pm .005$ inch, termination thickness $\pm .002$ inch, cap diameter $\pm .005$ inch.



INTERNET <http://www.minicircuits.com>

P.O. Box 350166, Brooklyn, New York 11235-0003 (718) 934-4500 Fax (718) 332-4661

Distribution Centers NORTH AMERICA 800-654-7949 • 417-335-5935 • Fax 417-335-5945 • EUROPE 44-1252-832600 • Fax 44-1252-837010

Mini-Circuits ISO 9001 & ISO 14001 Certified

Tape & Reel Packaging TR-F26

DEVICE ORIENTATION IN T&R

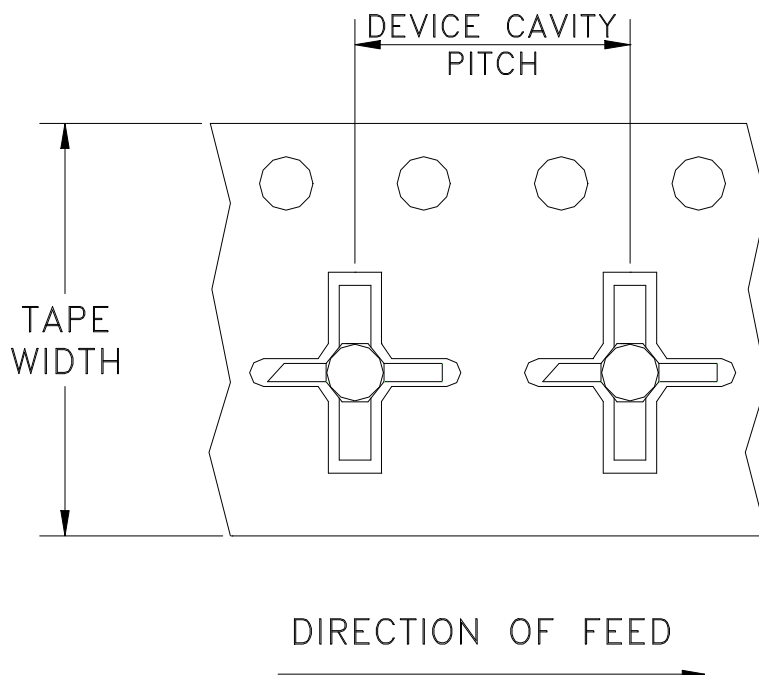

Tape Width, mm	Device Cavity Pitch, mm	Reel Size, inches	Devices per Reel
12	8	7	1000

Mini-Circuits carrier tape materials provide protection from ESD (Electro-Static Discharge) during handling and transportation. Tapes are static dissipative and comply with industry standards EIA-481/EIA-541.

Go to: www.minicircuits.com/pages/pdfs/tape.pdf



Distribution Centers NORTH AMERICA 800-654-7949 • 417-335-5935 • Fax 417-335-5945 • EUROPE 44-1252-832600 • Fax 44-1252-837010

Mini-Circuits ISO 9001 & ISO 14001 Certified

INTERNET <http://www.minicircuits.com>

P.O. Box 350166, Brooklyn, New York 11235-0003 (718) 934-4500 Fax (718) 332-4661

THIRD ANGLE PROJECTION

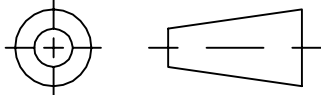

REVISIONS

REV	ECN No.	DESCRIPTION	DATE	DR	AUTH
OR	M100749	NEW RELEASE	09/19/05	MMG	MM
A	M102713	ADDED "...WITH SMOBC"	01/12/06	GT	IL

SUGGESTED MOUNTING CONFIGURATION FOR
AF320 CASE STYLES, "hl" PIN CONNECTION

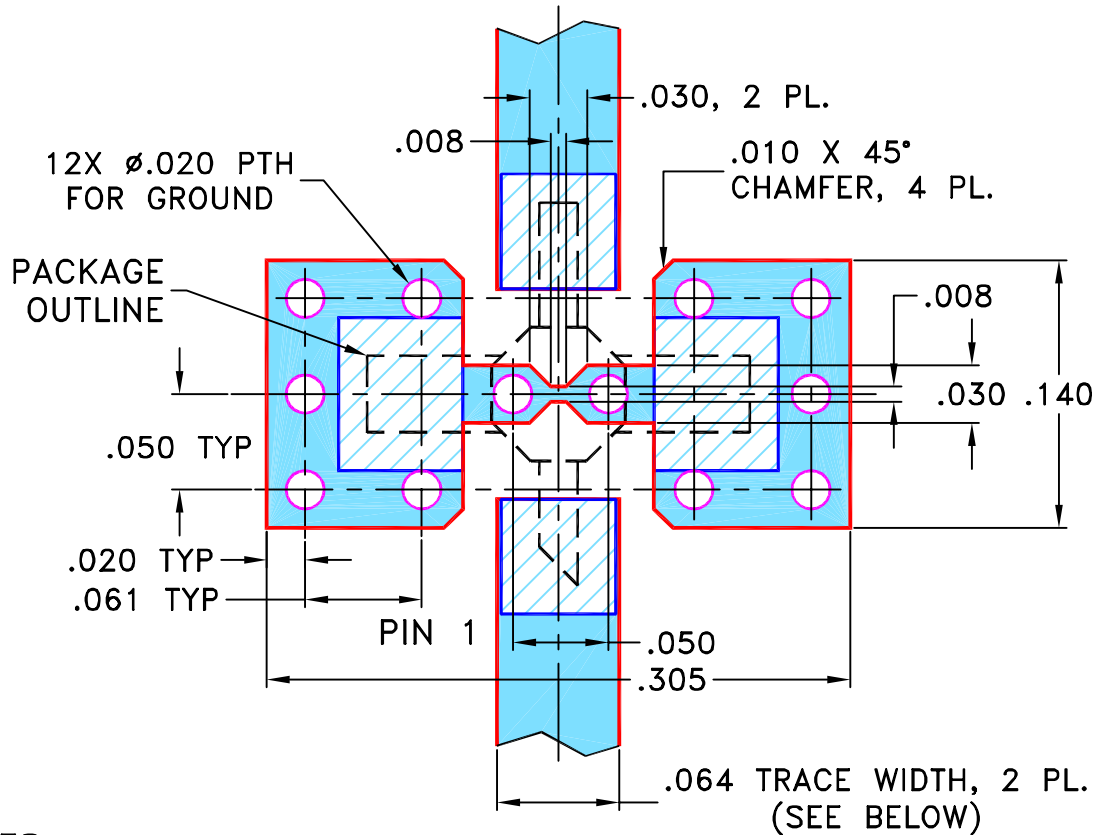

NOTES:

1. TRACE WIDTH IS SHOWN FOR ROGERS RO4350B WITH DIELECTRIC THICKNESS .030" ± .002"; COPPER: 1/2 OZ. EACH SIDE. FOR OTHER MATERIALS TRACE WIDTH MAY NEED TO BE MODIFIED.
2. BOTTOM SIDE OF THE PCB IS CONTINUOUS GROUND PLANE.



DENOTES PCB COPPER LAYOUT WITH SMOBC (SOLDER MASK OVER BARE COPPER)



DENOTES COPPER LAND PATTERN FREE OF SOLDER MASK

UNLESS OTHERWISE SPECIFIED

INITIALS

DATE

DIMENSIONS ARE IN INCHES

DRAWN

MMG

09/12/05

TOLERANCES ON:

CHECKED

AV

09/16/05

2 PL DECIMALS ± .005

APPROVED

MM

09/19/05

3 PL DECIMALS ± .005

ANGLES ± 1°

FRACTIONS ±

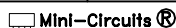

THIS DOCUMENT AND ITS CONTENTS ARE THE PROPERTY OF MINI-CIRCUITS. EXCEPT FOR USE EXPRESSLY GRANTED, IN WRITING, TO ITS VENDORS, VENDEE AND THE UNITED STATES GOVERNMENT, MINI-CIRCUITS RESERVES ALL PROPRIETARY DESIGN, USE, MANUFACTURING AND REPRODUCTION RIGHTS THERETO. THESE CONTENTS SHALL NOT BE USED, DUPLICATED OR DISCLOSED TO ANY OUTSIDE PARTY, IN WHOLE OR IN PART, WITHOUT WRITTEN PERMISSION OF MINI-CIRCUITS.

ASHEETA1.DWG REV:A DATE:01/12/95



Mini-Circuits®

13 Neptune Avenue
Brooklyn NY 11235

PL, hl, AF320, PAT, TB-319

SIZE
A

CODE IDENT
15542

DRAWING NO:
98-PL-208

REV:
A

FILE: 98PL208

SCALE: 10:1

SHEET: 1 OF 1

Evaluation Board and Circuit

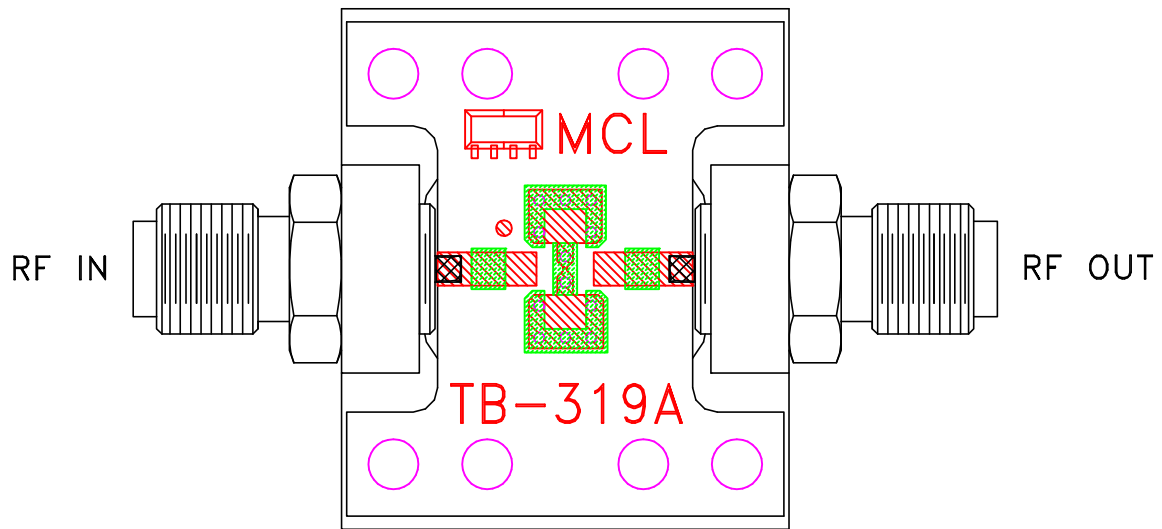

TB-319

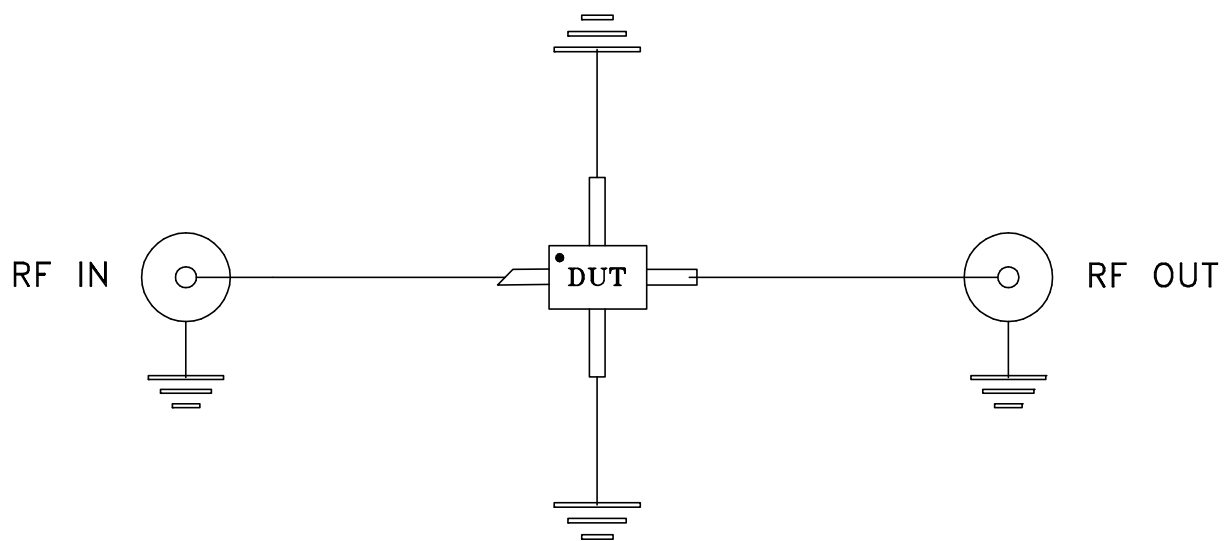

Schematic Diagram

Notes:

1. SMA Female connectors.
2. PCB Material: Rogers R04350 or equivalent,
Dielectric Constant=3.5, Thickness=.030 inch.

 **Mini-Circuits®**

All Mini-Circuits products are manufactured under exacting quality assurance and control standards, and are capable of meeting published specifications after being subjected to any or all of the following physical and environmental test.

Specification	Test/Inspection Condition	Reference/Spec
Operating Temperature	-54° to 100°C Ambient Environment	Individual Model Data Sheet
Storage Temperature	-65° to 150° C Ambient Environment	Individual Model Data Sheet
Autoclave	15 psig, 100% RH, 121°C, 96 hours	JESD22-A102-C, Condition C
Thermal Shock	-55° to 100°C, 100 cycles	MIL-STD-202, Method 107, Condition A-3, except +100°C
Mechanical Shock	1.5Kg, 0.5 ms, 5 shock pulses, Y1 direction only	MIL-STD-883, Method 2002, Condition B, except Y1 direction only
Vibration (Variable Frequency)	50g peak	MIL-STD-883, Method 2007, Condition B
Constant Acceleration	Y1 plane only, 5 Kg	MIL-STD-883, Method 2001, Condition A, except Y1 plane only
Seal	Perfluorocarbon gross leak	MIL-STD-883, Method 1014, Condition C
HAST	130°C, 85% RH, 96 hours	JESD22-A110
Solderability	10X Magnification	J-STD-002, Para 4.2.5, Test S, 95% Coverage
Solder Reflow Heat	Sn-Pb Eutetic Process: 240°C peak Pb-Free Process: 260°C peak	J-STD-020, Table 4-1, 4-2 and 5-2; Figure 5-1

All Mini-Circuits products are manufactured under exacting quality assurance and control standards, and are capable of meeting published specifications after being subjected to any or all of the following physical and environmental test.

Specification	Test/Inspection Condition	Reference/Spec
Moisture Sensitivity: Level 1	Bake at 125°C for 24 hours Soak at 85°C/85% RH for 168 hours, Reflow 3 cycles at 260°C peak	J-STD-020
Marking Resistance to Solvents	Isopropyl alcohol + mineral spirits at 25°C; terpene defluxer at 25°C; distilled water + proylene glycol monomethyl ether + monoethanolamine at 63°C to 70°C	MIL-STD-202, Method 215