



MICROWAVE PRECISION

Fixed Attenuator

QAT-8+

50Ω 1.2 W 8 dB DC to 50 GHz

THE BIG DEAL

- Small Package, 2x2 mm MCLP™
- Super Wide Bandwidth, DC to 50 GHz
- Excellent VSWR, 1.12:1 Typ. at 25 GHz
- High Power Handling, 1.2 W
- Protected by US Patent 11,784,146



Generic photo used for illustration purposes only

CASE STYLE: MC3000

+RoHS Compliant

The +Suffix identifies RoHS Compliance. See our website for methodologies and qualifications

APPLICATIONS

- 5G
- Test and Measurement
- Radar
- Communication
- Defense
- Satellite

PRODUCT OVERVIEW

QAT-8+ is an absorptive fixed attenuator fabricated using highly reliable and repeatable GaAs MMIC IPD* process. The model operates from DC to 50 GHz. It achieves outstanding attenuation accuracy and flatness while maintains excellent VSWR throughout the entire band. The model can also handle input power up to 1.2 W, which makes this model an ideal choice for a wide range of applications.

KEY FEATURES

Feature	Advantages
Wideband Operation, From DC to 50 GHz	Supports a wide array of applications including 5G, wireless infrastructure, microwave communications, satellite, defense and aerospace, medical broadband and optic applications.
Small Size and Simple to Use (2x2 mm)	As a single chip solution, the QAT series occupies less board space than a lumped element approach, minimizes component count and ensures repeatable performance over wide frequency range.
Wide Range of Nominal Attenuation Values (0,1,2,3,4,5,6,7,8,9,10,12,15,20 & 30)	Small increment offering enables circuit designer to change attenuation values without motherboard redesign making the QAT series ideal for select at test application.
MCLP™ Package	Low Inductance, repeatable transitions, excellent thermal path make the QAT series an ideal solution as an alternative to "do it yourself" lumped element-based approach.

* IPD - Integrated Passive Device

REV. C
ECO-022420
QAT-8+
MCL NY
250221





MICROWAVE PRECISION

Fixed Attenuator

QAT-8+

Mini-Circuits

50Ω 1.2 W 8 dB DC to 50 GHz

ELECTRICAL SPECIFICATIONS¹ AT +25°C, 50Ω, UNLESS NOTED OTHERWISE

Parameter	Condition (GHz)	Min.	Typ.	Max.	Unit
Frequency Range		DC		50	GHz
Attenuation	0.01 - 5	7.6	8.0	8.3	dB
	5 - 10	7.7	8.1	8.4	
	10 - 20	7.7	8.1	8.6	
	20 - 30	7.7	8.2	8.9	
	30 - 40		8.4		
	40 - 50		8.6		
VSWR	0.01 - 5		1.09	1.4	:1
	5 - 10		1.16	1.4	
	10 - 20		1.08	1.5	
	20 - 30		1.16		
	30 - 40		1.27		
	40 - 50		1.48		

1. Tested on Mini-Circuits test board TB-QAT-8C+. See Characterization/Application Circuit in Fig. 1. Bi-directional RF-IN and RF-OUT ports can be interchanged. See S-Parameters for actual performance.

ABSOLUTE MAXIMUM RATINGS²

Parameter	Ratings
Operating Case Temperature	-55°C to +105°C
Storage Temperature	-65°C to +150°C
RF Input Power ³	1.2 W

2. Permanent damage may occur if any of these limits are exceeded.

3. Power rating derated to 0.9 W at +85°C and 0.8 W at +105°C.





MICROWAVE PRECISION

Fixed Attenuator

QAT-8+

Mini-Circuits

50Ω 1.2 W 8 dB DC to 50 GHz

PAD DESCRIPTION

Function	Pad Number	Description
RF-IN	2	RF input pad
RF-OUT	5	RF output pad
GND	1,3,4,6 & Paddle	Ground

TOP VIEW

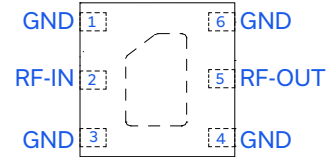

CHARACTERIZATION TEST CIRCUIT

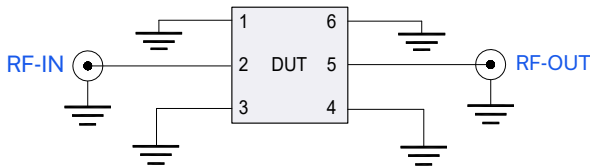
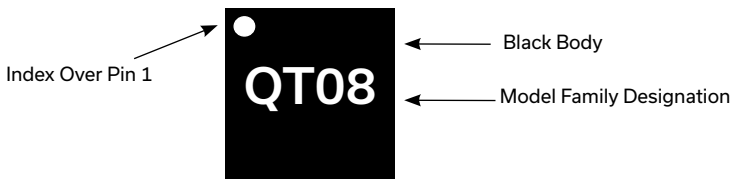

Fig 1. Block diagram of Test Circuit used for characterization, Test board TB-QAT-8C+
Conditions: Attenuation, VSWR: $P_{IN}=0$ dBm

PRODUCT MARKING



Marking may contain other features or characters for internal lot control.





MICROWAVE PRECISION

Fixed Attenuator

QAT-8+

Mini-Circuits

50Ω 1.2 W 8 dB DC to 50 GHz

ADDITIONAL DETAILED TECHNICAL INFORMATION IS AVAILABLE ON OUR DASHBOARD.

[CLICK HERE](#)

Performance Data	Data Table Swept Graphs S-Parameter (S2P Files) Data Set (.zip file)
Case Style	MC3000 Plastic package, Terminal finish: Matte Tin
Tape & Reel Standard Quantities Available on Reel	F66 7" Reels with 20, 50, 100, 200, 500, 1K, 2K or 3K devices
Suggested Layout for PCB Design	PL-676
Evaluation Board	TB-QAT-8+ (without connectors) TB-QAT-8C+ (with connectors)
Environmental Ratings	ENV08T1

ESD RATING

Human Body Model (HBM): Class 2 (Pass 2000 V) per ANSI/ESD STM 5.1 - 2001

MSL RATING

Moisture Sensitivity: MSL1 in accordance with IPC/JEDEC J-STD-020D

NOTES

- A. Performance and quality attributes and conditions not expressly stated in this specification document are intended to be excluded and do not form a part of this specification document.
- B. Electrical specifications and performance data contained in this specification document are based on Mini-Circuit's applicable established test performance criteria and measurement instructions.
- C. The parts covered by this specification document are subject to Mini-Circuits standard limited warranty and terms and conditions (collectively, "Standard Terms"); Purchasers of this part are entitled to the rights and benefits contained therein. For a full statement of the standard terms and the exclusive rights and remedies thereunder, please visit Mini-Circuits' website at www.minicircuits.com/terms/viewterm.html



Typical Performance Data

FREQ.	ATTENUATION			INPUT VSWR			OUTPUT VSWR		
	(dB)			(:1)			(:1)		
	(MHz)	@-55°C	@25°C	@+105°C	@-55°C	@25°C	@+105°C	@-55°C	@25°C
10	7.99	7.96	7.97	1.13	1.14	1.14	1.13	1.14	1.15
20	8.02	7.97	7.98	1.09	1.09	1.10	1.08	1.10	1.10
30	8.02	7.98	7.98	1.07	1.08	1.09	1.07	1.09	1.09
40	8.02	7.98	7.98	1.07	1.08	1.09	1.06	1.08	1.09
50	8.03	7.98	7.99	1.07	1.08	1.08	1.06	1.08	1.09
60	8.03	7.98	7.99	1.06	1.08	1.08	1.06	1.08	1.09
70	8.03	7.98	7.99	1.06	1.07	1.08	1.06	1.08	1.08
80	8.03	7.98	7.99	1.06	1.07	1.08	1.06	1.08	1.08
90	8.03	7.98	7.99	1.06	1.07	1.08	1.06	1.08	1.08
100	8.03	7.99	7.99	1.06	1.07	1.08	1.06	1.08	1.08
200	8.03	7.99	8.00	1.06	1.07	1.08	1.05	1.07	1.08
400	8.03	7.99	8.00	1.05	1.06	1.07	1.05	1.07	1.07
600	8.03	8.00	8.00	1.05	1.06	1.07	1.05	1.07	1.07
800	8.04	8.00	8.01	1.05	1.06	1.06	1.05	1.07	1.07
1000	8.04	8.00	8.02	1.05	1.06	1.06	1.05	1.07	1.07
2000	8.06	8.03	8.04	1.05	1.06	1.07	1.07	1.07	1.08
3000	8.08	8.04	8.04	1.07	1.08	1.09	1.08	1.09	1.10
4000	8.09	8.05	8.06	1.11	1.11	1.11	1.11	1.10	1.11
5000	8.10	8.07	8.08	1.13	1.12	1.13	1.12	1.10	1.11
6000	8.12	8.09	8.10	1.15	1.14	1.15	1.14	1.12	1.13
7000	8.13	8.11	8.14	1.16	1.16	1.17	1.15	1.15	1.15
8000	8.14	8.13	8.15	1.18	1.18	1.18	1.17	1.16	1.16
9000	8.13	8.11	8.14	1.17	1.16	1.16	1.16	1.14	1.14
10000	8.10	8.09	8.13	1.14	1.12	1.11	1.11	1.09	1.08
11000	8.10	8.10	8.13	1.11	1.08	1.06	1.07	1.04	1.02
12000	8.13	8.12	8.15	1.12	1.08	1.06	1.11	1.06	1.04
13000	8.13	8.13	8.17	1.12	1.09	1.07	1.11	1.08	1.06
14000	8.12	8.13	8.17	1.10	1.08	1.07	1.09	1.07	1.06
15000	8.12	8.13	8.18	1.09	1.07	1.06	1.07	1.06	1.05
16000	8.13	8.14	8.19	1.09	1.07	1.06	1.06	1.04	1.03
17000	8.14	8.15	8.20	1.08	1.07	1.05	1.03	1.03	1.02
18000	8.15	8.16	8.21	1.07	1.07	1.06	1.04	1.06	1.06
19000	8.16	8.17	8.22	1.11	1.11	1.11	1.11	1.13	1.13
20000	8.17	8.19	8.24	1.16	1.14	1.13	1.18	1.18	1.17
21000	8.20	8.21	8.26	1.17	1.13	1.09	1.23	1.19	1.17
22000	8.20	8.21	8.24	1.12	1.09	1.05	1.18	1.17	1.13
23000	8.15	8.20	8.23	1.04	1.05	1.02	1.11	1.12	1.08
24000	8.13	8.18	8.23	1.08	1.07	1.08	1.08	1.08	1.07
25000	8.16	8.20	8.27	1.17	1.13	1.15	1.16	1.12	1.14
26000	8.19	8.23	8.30	1.20	1.17	1.20	1.21	1.19	1.22
27000	8.20	8.24	8.32	1.16	1.18	1.20	1.24	1.23	1.25
28000	8.20	8.25	8.33	1.12	1.15	1.17	1.25	1.23	1.25
29000	8.21	8.24	8.30	1.10	1.10	1.12	1.24	1.21	1.20
30000	8.18	8.22	8.28	1.08	1.05	1.06	1.15	1.15	1.12
31000	8.19	8.24	8.31	1.12	1.09	1.07	1.05	1.11	1.08
32000	8.27	8.27	8.35	1.23	1.16	1.14	1.17	1.15	1.15
33000	8.31	8.31	8.39	1.30	1.23	1.22	1.27	1.23	1.26
34000	8.32	8.34	8.42	1.35	1.30	1.30	1.35	1.33	1.37
35000	8.32	8.37	8.45	1.39	1.38	1.38	1.41	1.42	1.45
36000	8.35	8.41	8.48	1.42	1.42	1.39	1.45	1.46	1.46
37000	8.41	8.45	8.51	1.45	1.40	1.34	1.47	1.43	1.39
38000	8.44	8.46	8.51	1.43	1.34	1.28	1.44	1.35	1.29
39000	8.34	8.37	8.41	1.30	1.25	1.21	1.35	1.26	1.20
40000	8.19	8.27	8.33	1.20	1.19	1.17	1.25	1.24	1.20
41000	8.18	8.28	8.41	1.16	1.17	1.20	1.25	1.27	1.30
42000	8.20	8.32	8.50	1.18	1.23	1.31	1.33	1.34	1.41
43000	8.30	8.43	8.58	1.30	1.36	1.40	1.37	1.41	1.47
44000	8.44	8.53	8.66	1.49	1.48	1.47	1.46	1.48	1.48
45000	8.61	8.66	8.75	1.61	1.57	1.52	1.58	1.54	1.50
46000	8.70	8.75	8.79	1.68	1.63	1.56	1.61	1.60	1.53
47000	8.70	8.78	8.78	1.69	1.63	1.53	1.59	1.64	1.52
48000	8.66	8.76	8.76	1.65	1.58	1.47	1.62	1.62	1.50
49000	8.65	8.73	8.83	1.61	1.53	1.45	1.65	1.56	1.49
50000	8.68	8.72	8.89	1.66	1.51	1.48	1.68	1.47	1.48



Typical Performance Curves

ATTENUATION vs. TEMPERATURE
INPUT POWER = 0 dBm

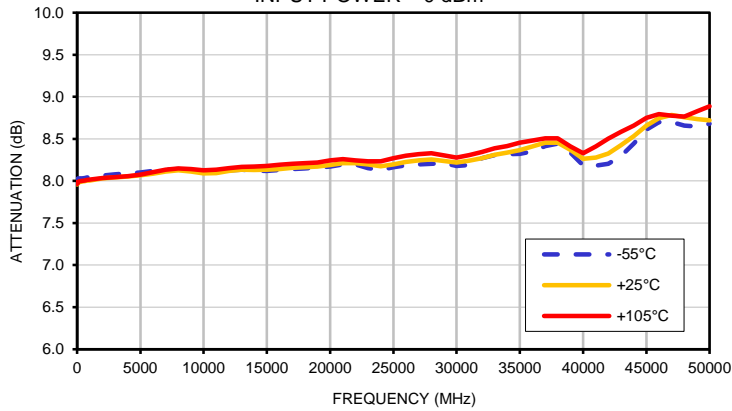

INPUT VSWR vs. TEMPERATURE
INPUT POWER = 0 dBm

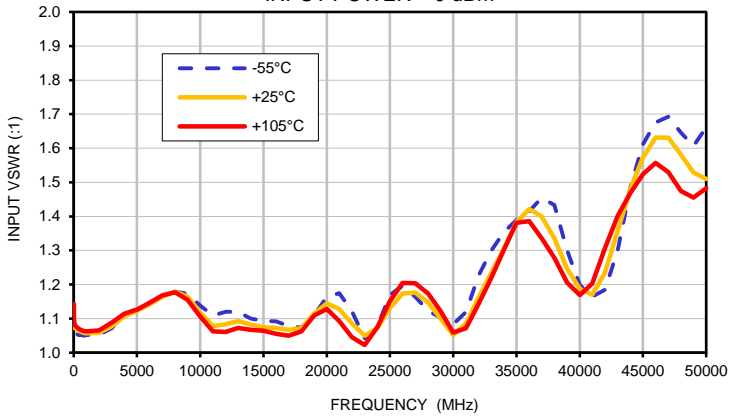

OUTPUT VSWR vs. TEMPERATURE
INPUT POWER = 0 dBm

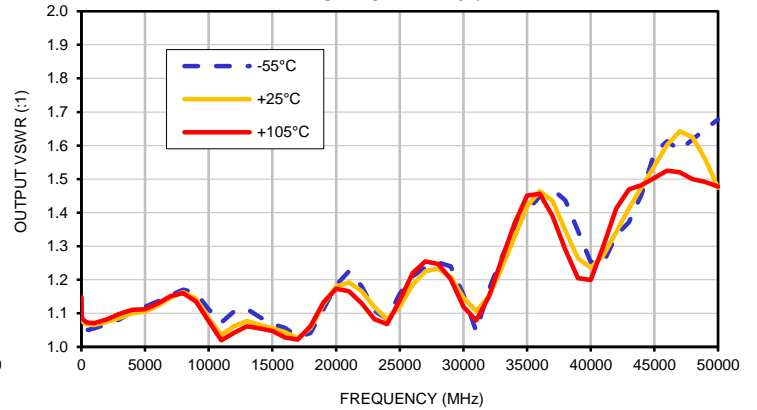

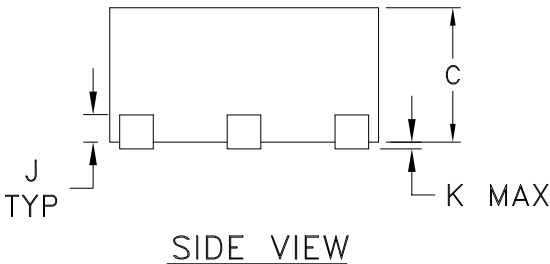
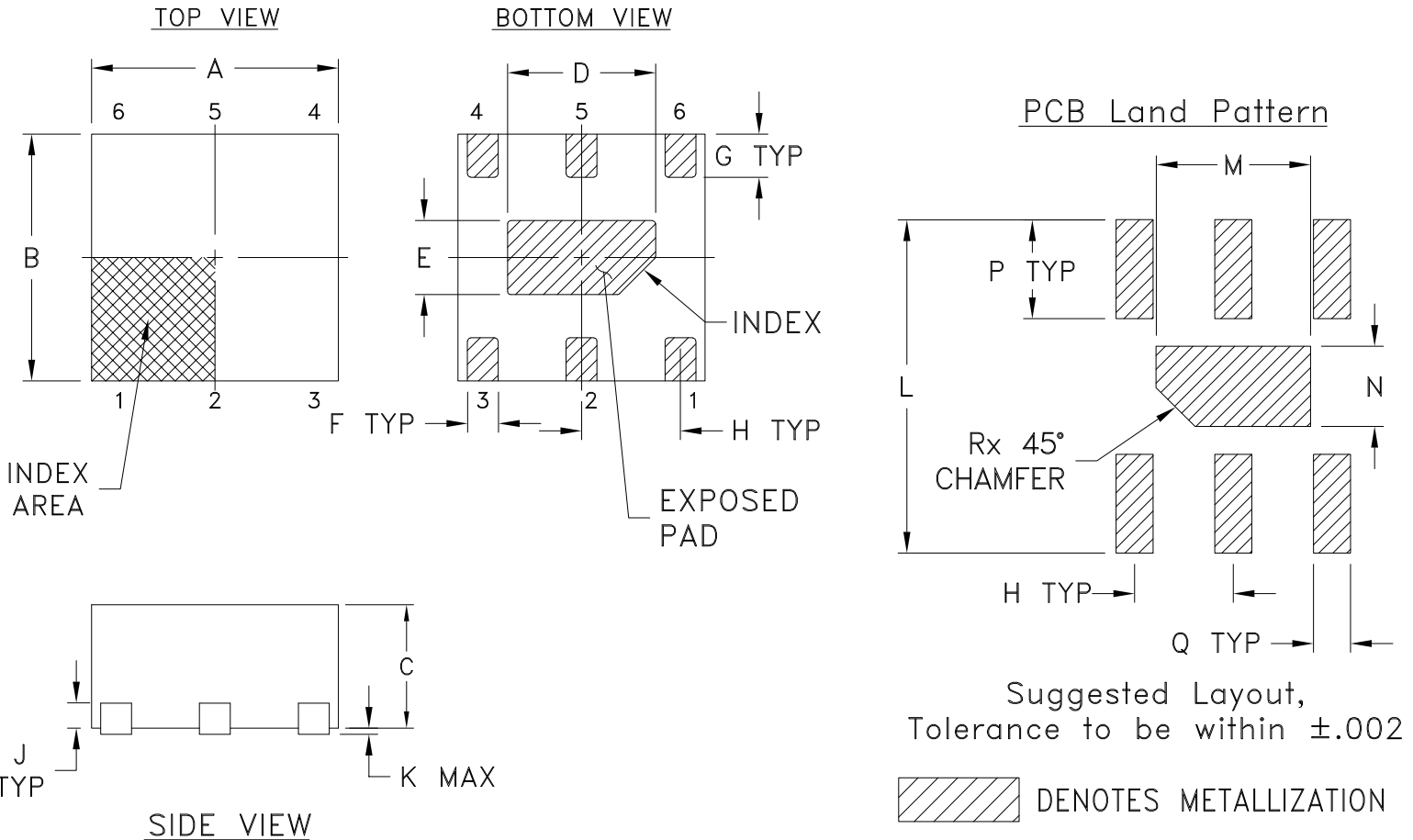

Suggested Layout,
Tolerance to be within $\pm .002$

DENOTES METALLIZATION

CASE#	A	B	C	D	E	F	G	H	J	K	L	M	N
MC3000	.079 (2.00)	.079 (2.00)	.039 (1.00)	.047 (1.20)	.024 (.60)	.010 (.25)	.014 (.35)	.031 (.80)	.008 (.20)	.002 (.05)	.106 (2.70)	.049 (1.25)	.026 (.65)
CASE #	P	Q	R	WT, GRAM									
MC3000	.031 (.80)	.012 (.30)	.012 (.30)	.006									

Dimensions are in inches (mm). Tolerances: 2 Pl. $\pm .01$; 3 Pl. $\pm .005$

Notes:

- Case material: Plastic.
- Termination finish:
For RoHS Case Styles: Tin-Silver over Nickel plated or Matte-Tin plated (See Data sheet).
All models, (+) suffix.
- Lead #1 identifier shall be located in the cross-hatched area shown.
Identifier may be either a molded or marked feature.

Tape & Reel Packaging TR-F66

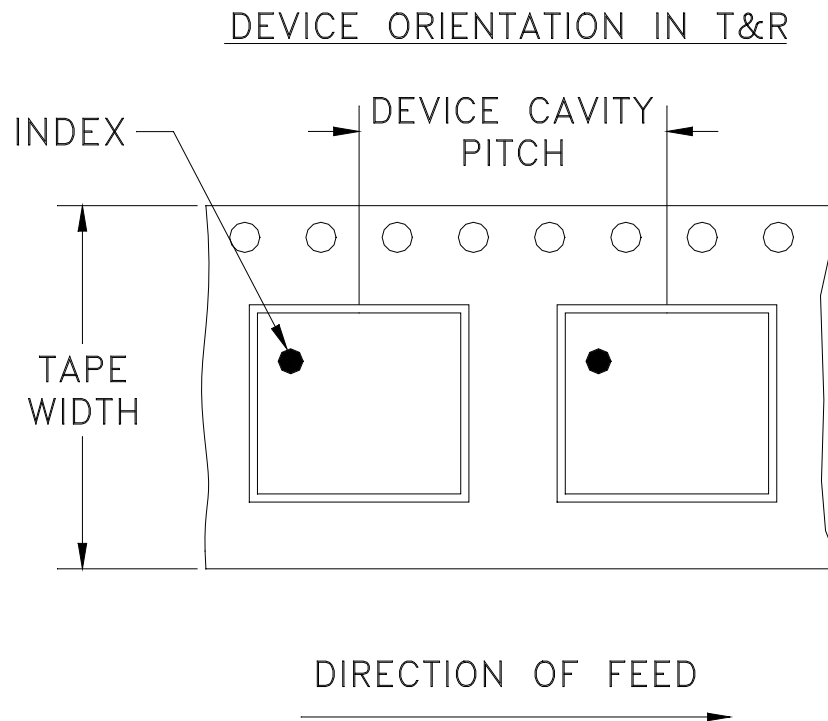

Tape Width, mm	Device Cavity Pitch, mm	Reel Size, inches	Devices per Reel see note	
8	4	7	Small quantity standard	20
				50
				100
				200
				500
		7	Standard	1000, 2000, 3000

Note: Please consult individual model data sheet to determine device per reel availability.

Mini-Circuits carrier tape materials provide protection from ESD (Electro-Static Discharge) during handling and transportation. Tapes are static dissipative and comply with industry standards EIA-481/EIA-541.

Go to: www.minicircuits.com/pages/pdfs/tape.pdf

Mini-Circuits®

INTERNET <http://www.minicircuits.com>

P.O. Box 350166, Brooklyn, New York 11235-0003 (718) 934-4500 Fax (718) 332-4661

Distribution Centers NORTH AMERICA 800-654-7949 • 417-335-5935 • Fax 417-335-5945 • EUROPE 44-1252-832600 • Fax 44-1252-837010

Mini-Circuits ISO 9001 & ISO 14001 Certified

THIRD ANGLE PROJECTION

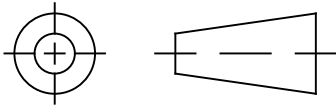

REVISIONS

REV	ECN No.	DESCRIPTION	DATE	DR	AUTH
OR	ECO-002800	NEW RELEASE	04/14/20	ITG	CC
A	ECO-003941	UPDATED DUT ROTATION		CA	

SUGGESTED MOUNTING CONFIGURATION FOR
MC3000 CASE STYLE

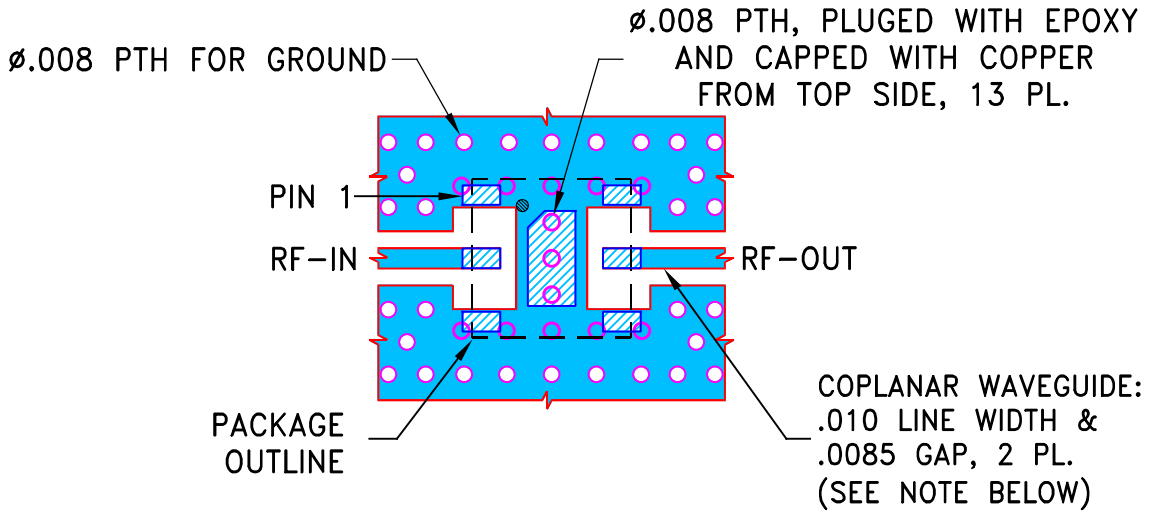

NOTES:

1. LINE WIDTH & GAP ARE SHOWN FOR ROGERS R04350B WITH DIELECTRIC THICKNESS $.0066 \pm .0007$ "; COPPER: 1 OZ. FOR OTHER MATERIALS LINE WIDTH & GAP MAY NEED TO BE MODIFIED.
2. BOTTOM SIDE OF THE PCB IS CONTINUOUS GROUND PLANE.

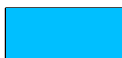
 DENOTES PCB COPPER LAYOUT WITH SMOBC (SOLDER MASK OVER BARE COPPER)

 DENOTES COPPER LAND PATTERN FREE OF SOLDER MASK

UNLESS OTHERWISE SPECIFIED	INITIALS		DATE
DIMENSIONS ARE IN INCHES TOLERANCES ON: 2 PL DECIMALS ± 3 PL DECIMALS ± .005 ANGLES ± FRACTIONS ±	DRAWN	ITG	06/02/20
	CHECKED	GF	06/02/20
	APPROVED	CC	06/02/20



Mini-Circuits® 13 Neptune Avenue
Brooklyn NY 11235

PL, MC3000, TB-QAT-XXC+

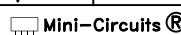
 Mini-Circuits®
THIS DOCUMENT AND ITS CONTENTS ARE THE PROPERTY OF MINI-CIRCUITS. EXCEPT FOR USE EXPRESSLY GRANTED, IN WRITING, TO ITS VENDORS, VENDEE AND THE UNITED STATES GOVERNMENT, MINI-CIRCUITS RESERVES ALL PROPRIETARY DESIGN, USE, MANUFACTURING AND REPRODUCTION RIGHTS THERETO. THESE CONTENTS SHALL NOT BE USED, DUPLICATED OR DISCLOSED TO ANY OUTSIDE PARTY, IN WHOLE OR IN PART, WITHOUT WRITTEN PERMISSION OF MINI-CIRCUITS.

SIZE A	CODE IDENT 15542	DRAWING NO: 98-PL-676	REV: A
FILE: 98PL676	SCALE: 10:1	SHEET: 1 OF 1	

Evaluation Board and Circuit

SEE DETAIL "A"

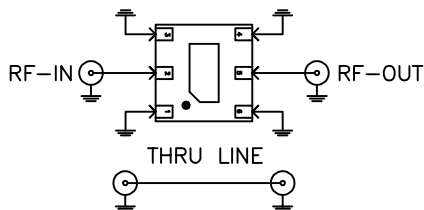
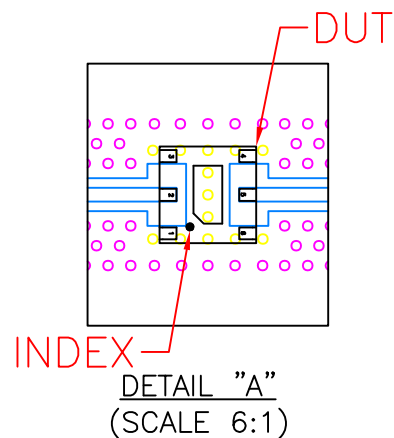
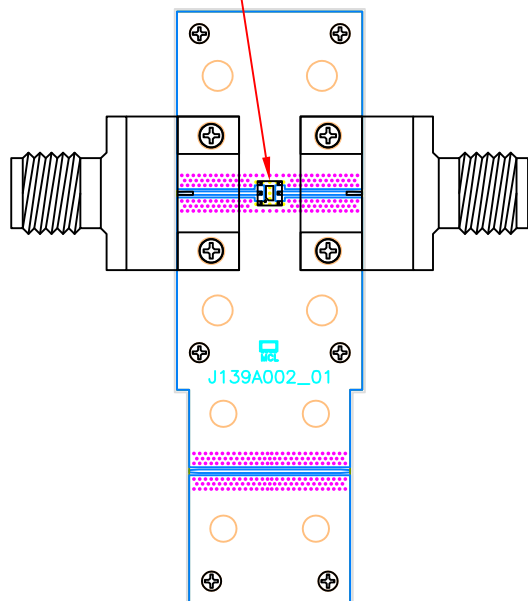

SCHEMATIC DIAGRAM
(SCALE 6:1)

Function	Pad
RF-IN	2
RF-OUT	5
GND	1,3,4,6

Notes:

- 2.4mm Female Connectors,
- PCB Material: Roger R04350B or equivalent,
Dielectric constant=3.5, Thickness=0.0066 inch

 Mini-Circuits®

Evaluation Board and Circuit

SEE DETAIL "A"

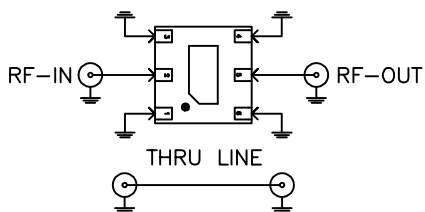
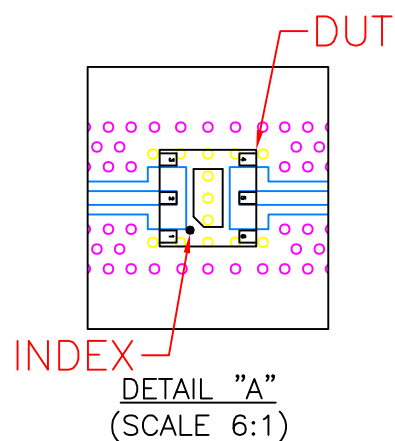
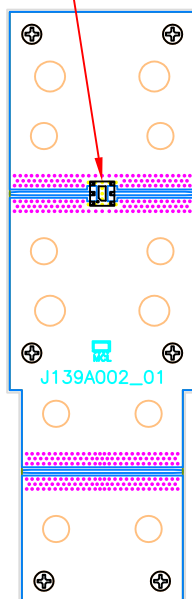

SCHMATIC DIAGRAM
(SCALE 6:1)

Function	Pad
RF-IN	2
RF-OUT	5
GND	1,3,4,6

Notes:

1. PCB Material: Roger R04350B or equivalent,
Dielectric constant=3.5, Thickness=0.0066 inch

 Mini-Circuits®

All Mini-Circuits products are manufactured under exacting quality assurance and control standards, and are capable of meeting published specifications after being subjected to any or all of the following physical and environmental test.

Specification	Test/Inspection Condition	Reference/Spec
Operating Temperature	-40° to 85° C or -45° to 85° C or -55° to 105° C or -40° to 105° C or -40° to 95° C Ambient Environment	Individual Model Data Sheet
Storage Temperature	-55° to 100° C or -65° to 150° Ambient Environment	Individual Model Data Sheet
HTOL	1000 hours at 125°C	MIL-STD-883, Method 1005, Condition B
Thermal Shock	-55° to 100°C, 100 cycles	MIL-STD-202, Method 107, Condition A-3, except +100°C
Mechanical Shock	1.5Kg, 0.5 ms, 5 shock pulses, Y1 direction only	MIL-STD-883, Method 2002, Condition B, except Y1 direction only
Vibration (Variable Frequency)	50g peak	MIL-STD-883, Method 2007, Condition B
Autoclave	15 psig, 100% RH, 121°C, 96 hours	JESD22-A102, Condition C
HAST	130°C, 85% RH, 96 hours	JESD22-A110
Solderability	10X Magnification	J-STD-002, Para 4.2.5, Test S, 95% Coverage
Solder Reflow Heat	Sn-Pb Eutetic Process: 240°C peak Pb-Free Process: 260°C peak	J-STD-020, Table 4-1, 4-2 and 5-2; Figure 5-1
Moisture Sensitivity: Level 1	Bake at 125°C for 24 hours Soak at 85°C/85% RH for 168 hours, Reflow 3 cycles at 260°C peak	J-STD-020



All Mini-Circuits products are manufactured under exacting quality assurance and control standards, and are capable of meeting published specifications after being subjected to any or all of the following physical and environmental test.

Specification	Test/Inspection Condition	Reference/Spec
Marking Resistance to Solvents	Isopropyl alcohol + mineral spirits at 25°C; terpene defluxer at 25°C; distilled water + proylene glycol monomethyl ether + monoethanolamine at 63°C to 70°C	MIL-STD-202, Method 215