

Surface Mount Power Splitter/Combiner

QBA-20W+ QBA-20W

2 Way-90° 50Ω 1500 to 2200 MHz



Generic photo used for illustration purposes only

CASE STYLE: SM33

Maximum Ratings

Operating Temperature	-55°C to 100°C
Storage Temperature	-55°C to 100°C

Permanent damage may occur if any of these limits are exceeded.

Pin Connections

SUM PORT	1
PORT 1 (+90°)	10
PORT 2 (0°)	6
GROUND	2,3,4,7,8,9
50 OHM TERM EXTERNAL	5

Outline Drawing

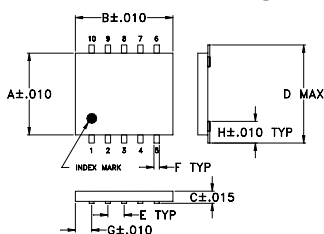

PCB Land Pattern

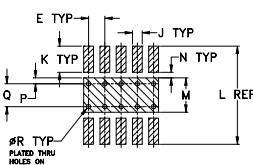

Suggested Layout,
Tolerance to be within ±.002
ADJACENT GROUND PINS SHALL BE CONNECTED TO EACH OTHER AND TO GROUND PAD

Outline Dimensions (inch/mm)

A	B	C	D	E	F	G	H	
.250	.300	.050	.310	.050	.015	.050	.066	
6.35	7.62	1.27	7.87	1.27	0.38	1.27	1.68	
J	K	L	M	N	P	Q	R	wt
.030	.095	.330	.100	.020	.015	.070	.014	grams
0.76	2.41	8.38	2.54	0.51	0.38	1.78	0.36	0.2

Demo Board MCL P/N: TB-115+ Suggested PCB Layout (PL-004)

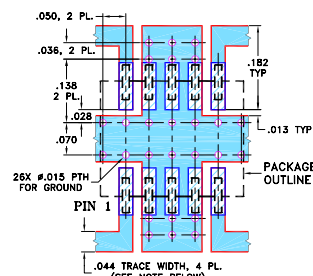

NOTE: 1. TRACE WIDTH IS SHOWN FOR ROGERS RO4550B WITH DIELECTRIC THICKNESS .020 ± .0015; COPPER: 1/2 OZ. EACH SIDE. FOR OTHER MATERIALS TRACE WIDTH MAY NEED TO BE MODIFIED.
2. BOTTOM SIDE OF THE PCB IS CONTINUOUS GROUND PLANE.
■ DENOTES PCB COPPER LAYOUT WITH SMOBC (SOLDER MASK OVER BARE COPPER)
▨ DENOTES COPPER LAND PATTERN FREE OF SOLDER MASK

Notes

A. Performance and quality attributes and conditions not expressly stated in this specification document are intended to be excluded and do not form a part of this specification document.
B. Electrical specifications and performance data contained in this specification document are based on Mini-Circuit's applicable established test performance criteria and measurement instructions.
C. The parts covered by this specification document are subject to Mini-Circuit's standard limited warranty and terms and conditions (collectively, "Standard Terms"); Purchasers of this part are entitled to the rights and benefits contained therein. For a full statement of the Standard Terms and the exclusive rights and remedies thereunder, please visit Mini-Circuit's website at www.minicircuits.com/MCLStore/terms.jsp

Features

- insertion loss, 0.45 dB typ.
- high power capability, 25W
- good isolation, 23 dB typ.
- ceramic body, good for heat dissipation
- solder plated leads for excellent solderability
- aqueous washable
- protected by U.S. Patent 5,534,830

Applications

- PCS
- GSM
- GPS
- VSAT

Electrical Specifications

FREQ. RANGE (MHz)	ISOLATION (dB)		INSERTION LOSS ¹ (dB) Avg. of Coupled Outputs ABOVE 3 dB			PHASE UNBALANCE (Degrees)	AMPLITUDE UNBALANCE (dB)	INPUT POWER ² (W)
	Typ.	Min.	f_L	f_U	σ			
f_L - f_U			\bar{X}	\bar{X}	σ	Max.	Max.	below 25°C
1500-2200	23	16	0.41	0.58	0.02	5.0	1.2	25

1. Includes test fixture losses.
2. Derate linearly to 5W at 100°C
Thermal compound may be applied to decrease body temperature. See application note AN-10-007

Typical Performance Data

Frequency (MHz)	Total Loss ¹ (dB)		Amplitude Unbalance (dB)	Isolation (dB)	Phase Unbalance (deg.)	VSWR S	VSWR 1	VSWR 2
	S-1	S-2						
1500.00	3.75	3.03	0.72	23.90	88.51	1.16	1.21	1.19
1550.00	3.70	3.10	0.60	24.16	88.46	1.16	1.20	1.21
1600.00	3.64	3.17	0.48	23.85	88.46	1.17	1.18	1.20
1650.00	3.57	3.22	0.34	23.82	88.53	1.17	1.18	1.22
1700.00	3.56	3.29	0.27	23.78	88.54	1.17	1.18	1.21
1750.00	3.52	3.37	0.16	23.35	88.46	1.17	1.19	1.21
1800.00	3.49	3.40	0.08	23.34	88.39	1.17	1.18	1.22
1850.00	3.48	3.45	0.03	23.15	88.27	1.18	1.16	1.21
1900.00	3.48	3.51	0.03	22.53	88.14	1.16	1.17	1.21
1950.00	3.46	3.49	0.03	22.87	88.31	1.17	1.18	1.22
2000.00	3.49	3.56	0.07	22.04	88.39	1.16	1.19	1.21
2050.00	3.50	3.53	0.03	22.09	88.45	1.17	1.18	1.24
2100.00	3.54	3.56	0.03	21.63	88.23	1.16	1.17	1.23
2150.00	3.55	3.55	0.00	21.39	88.33	1.16	1.18	1.24
2200.00	3.59	3.52	0.06	21.06	88.26	1.15	1.20	1.25

1. Total Loss = Insertion Loss + 3dB splitter loss.

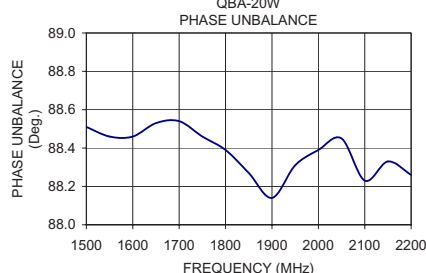
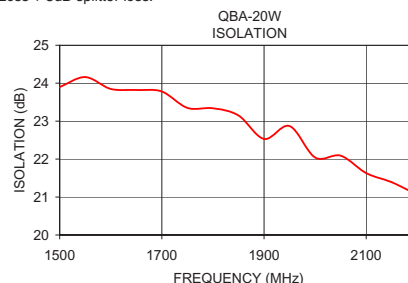
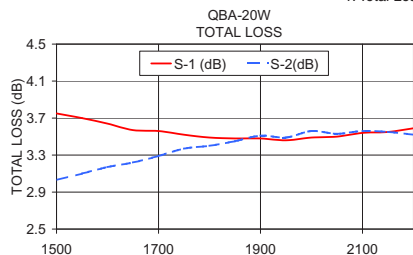

electrical schematic

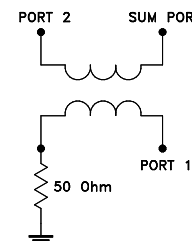

2 Way-90° Power Splitter/Combiner

QBA-20W

Typical Performance Data

TEST CONDITIONS: INPUT POWER = 0dBm @Temperature = +25°C

FREQ. (MHz)	TOTAL LOSS ¹ (dB)			AMP. UNBAL. (dB)	PHASE UNBAL. (deg.)	ISOLATION (dB)	VSWR (:1)		
	S-1	S-2	AVG.				S	1	2
850	6.04	1.56	3.80	4.48	92.15	22.62	1.07	1.26	1.05
900	5.75	1.68	3.71	4.07	92.12	22.80	1.08	1.25	1.05
950	5.48	1.79	3.63	3.69	92.07	23.05	1.09	1.25	1.06
1000	5.23	1.91	3.57	3.33	92.06	23.33	1.09	1.24	1.06
1050	5.01	2.01	3.51	3.00	92.05	23.67	1.10	1.22	1.07
1100	4.82	2.13	3.47	2.69	92.01	24.04	1.11	1.21	1.08
1150	4.63	2.24	3.43	2.40	92.00	24.44	1.11	1.20	1.09
1200	4.47	2.35	3.41	2.13	92.01	24.84	1.12	1.18	1.10
1250	4.32	2.45	3.39	1.87	92.00	25.20	1.13	1.17	1.11
1300	4.19	2.55	3.37	1.64	92.01	25.48	1.14	1.15	1.12
1350	4.07	2.64	3.36	1.43	91.99	25.63	1.14	1.13	1.13
1400	3.97	2.74	3.35	1.23	92.02	25.62	1.15	1.12	1.14
1450	3.87	2.83	3.35	1.05	92.04	25.51	1.16	1.10	1.15
1500	3.79	2.90	3.35	0.89	92.06	25.16	1.17	1.09	1.16
1550	3.72	2.98	3.35	0.75	92.05	24.75	1.18	1.08	1.17
1600	3.66	3.05	3.36	0.61	92.08	24.22	1.19	1.07	1.19
1650	3.61	3.12	3.37	0.49	92.11	23.59	1.20	1.07	1.20
1700	3.57	3.18	3.38	0.38	92.19	22.96	1.21	1.08	1.21
1750	3.53	3.24	3.38	0.29	92.19	22.25	1.22	1.09	1.22
1800	3.52	3.29	3.40	0.23	92.21	21.60	1.23	1.11	1.23
1850	3.50	3.33	3.41	0.17	92.22	20.95	1.24	1.13	1.25
1900	3.49	3.36	3.43	0.13	92.18	20.32	1.25	1.15	1.26
1950	3.49	3.40	3.45	0.09	92.18	19.69	1.26	1.17	1.27
2000	3.50	3.43	3.47	0.07	92.17	19.12	1.26	1.20	1.28
2050	3.51	3.45	3.48	0.06	92.10	18.61	1.27	1.23	1.30
2100	3.54	3.47	3.50	0.07	92.05	18.07	1.28	1.26	1.31
2150	3.57	3.48	3.52	0.09	92.05	17.57	1.29	1.28	1.32
2200	3.60	3.49	3.54	0.11	91.92	17.13	1.30	1.32	1.33
2250	3.64	3.49	3.57	0.15	91.84	16.71	1.31	1.35	1.34
2300	3.69	3.49	3.59	0.20	91.76	16.32	1.32	1.38	1.35
2350	3.75	3.49	3.62	0.26	91.71	15.94	1.33	1.41	1.36
2400	3.81	3.48	3.64	0.33	91.61	15.60	1.34	1.44	1.37
2450	3.89	3.46	3.67	0.43	91.61	15.27	1.35	1.47	1.38
2500	3.97	3.44	3.71	0.53	91.48	15.00	1.36	1.51	1.39
2550	4.07	3.40	3.73	0.67	91.39	14.70	1.37	1.55	1.39
2600	4.16	3.36	3.76	0.80	91.26	14.45	1.37	1.59	1.40
2650	4.28	3.32	3.80	0.96	91.16	14.19	1.38	1.62	1.40
2700	4.41	3.27	3.84	1.14	91.10	13.91	1.39	1.66	1.40
2750	4.57	3.20	3.88	1.36	90.92	13.67	1.39	1.70	1.41
2800	4.71	3.15	3.93	1.56	90.77	13.43	1.39	1.75	1.41
2850	4.91	3.08	3.99	1.83	90.56	13.17	1.40	1.80	1.41
2900	5.10	3.01	4.05	2.10	90.36	12.90	1.40	1.85	1.40
2950	5.33	2.92	4.12	2.41	90.08	12.66	1.39	1.91	1.40
3000	5.59	2.84	4.22	2.75	89.73	12.40	1.39	1.98	1.39
3050	5.87	2.74	4.31	3.13	89.16	12.15	1.39	2.05	1.39
3100	6.18	2.65	4.42	3.53	88.47	11.93	1.38	2.14	1.39

¹ Total Loss = Insertion Loss+ 3dB Splitter Loss



2 Way-90° Power Splitter/Combiner

QBA-20W

Typical Performance Data

TEST CONDITIONS: INPUT POWER = 0dBm @Temperature = -55°C

FREQ. (MHz)	TOTAL LOSS ¹ (dB)			AMP. UNBAL. (dB)	PHASE UNBAL. (deg.)	ISOLATION (dB) 1-2	VSWR (:1)		
	S-1	S-2	AVG.				S	1	2
850	5.92	1.39	3.66	4.53	91.45	22.58	1.08	1.27	1.05
900	5.62	1.50	3.56	4.12	91.39	22.74	1.08	1.26	1.06
950	5.34	1.61	3.47	3.73	91.29	23.03	1.09	1.26	1.07
1000	5.08	1.72	3.40	3.36	91.27	23.14	1.10	1.24	1.07
1050	4.85	1.82	3.34	3.03	91.24	23.47	1.10	1.24	1.08
1100	4.65	1.93	3.29	2.72	91.17	23.68	1.11	1.22	1.07
1150	4.46	2.03	3.25	2.44	91.13	24.19	1.11	1.21	1.08
1200	4.30	2.13	3.21	2.18	91.10	24.58	1.12	1.20	1.08
1250	4.14	2.22	3.18	1.92	91.02	25.07	1.12	1.18	1.09
1300	4.00	2.31	3.16	1.69	90.99	25.60	1.12	1.16	1.10
1350	3.88	2.40	3.14	1.47	90.91	25.74	1.14	1.15	1.12
1400	3.76	2.49	3.13	1.27	90.89	25.84	1.14	1.12	1.12
1450	3.66	2.58	3.12	1.09	90.88	25.73	1.16	1.10	1.14
1500	3.57	2.64	3.11	0.93	90.87	25.72	1.16	1.08	1.15
1550	3.49	2.72	3.11	0.77	90.83	25.26	1.18	1.07	1.17
1600	3.43	2.79	3.11	0.64	90.82	24.78	1.19	1.06	1.18
1650	3.37	2.85	3.11	0.52	90.80	23.98	1.20	1.05	1.19
1700	3.33	2.91	3.12	0.42	90.82	23.27	1.22	1.05	1.22
1750	3.28	2.97	3.13	0.31	90.78	22.37	1.23	1.07	1.24
1800	3.27	3.01	3.14	0.26	90.78	21.64	1.24	1.09	1.26
1850	3.25	3.06	3.15	0.19	90.72	20.84	1.25	1.11	1.29
1900	3.23	3.09	3.16	0.14	90.65	20.04	1.27	1.14	1.30
1950	3.23	3.13	3.18	0.10	90.57	19.39	1.27	1.17	1.33
2000	3.24	3.16	3.20	0.08	90.51	18.70	1.29	1.20	1.34
2050	3.24	3.18	3.21	0.06	90.40	18.08	1.30	1.23	1.36
2100	3.26	3.21	3.23	0.05	90.35	17.56	1.31	1.26	1.36
2150	3.28	3.21	3.25	0.07	90.28	16.99	1.32	1.29	1.37
2200	3.31	3.22	3.26	0.09	90.08	16.56	1.33	1.33	1.38
2250	3.33	3.23	3.28	0.10	90.03	16.10	1.34	1.36	1.39
2300	3.37	3.22	3.29	0.15	89.90	15.75	1.35	1.40	1.39
2350	3.42	3.21	3.32	0.21	89.81	15.35	1.37	1.44	1.40
2400	3.47	3.21	3.34	0.26	89.73	14.98	1.38	1.48	1.40
2450	3.54	3.18	3.36	0.35	89.75	14.69	1.39	1.51	1.39
2500	3.59	3.16	3.38	0.43	89.67	14.45	1.39	1.54	1.40
2550	3.68	3.11	3.40	0.57	89.64	14.13	1.42	1.59	1.38
2600	3.76	3.07	3.41	0.69	89.54	13.99	1.41	1.62	1.39
2650	3.86	3.01	3.44	0.85	89.48	13.72	1.43	1.65	1.39
2700	3.98	2.95	3.46	1.03	89.42	13.54	1.42	1.69	1.39
2750	4.11	2.88	3.49	1.22	89.38	13.32	1.43	1.73	1.38
2800	4.25	2.80	3.53	1.45	89.35	13.13	1.42	1.77	1.38
2850	4.44	2.72	3.58	1.72	89.26	12.91	1.41	1.83	1.39
2900	4.62	2.64	3.63	1.99	89.04	12.72	1.42	1.89	1.37
2950	4.85	2.54	3.69	2.31	88.83	12.50	1.40	1.94	1.38
3000	5.10	2.42	3.76	2.68	88.40	12.30	1.40	2.01	1.37
3050	5.35	2.31	3.83	3.04	87.75	12.15	1.38	2.09	1.37
3100	5.66	2.21	3.94	3.45	87.23	11.86	1.38	2.17	1.37

¹ Total Loss = Insertion Loss+ 3dB Splitter Loss



2 Way-90° Power Splitter/Combiner

QBA-20W

Typical Performance Data

TEST CONDITIONS: INPUT POWER = 0dBm @Temperature = +100°C

FREQ. (MHz)	TOTAL LOSS ¹ (dB)			AMP. UNBAL. (dB)	PHASE UNBAL. (deg.)	ISOLATION (dB)	VSWR (:1)		
	S-1	S-2	AVG.				S	1	2
850	6.07	1.63	3.85	4.44	92.46	23.01	1.06	1.25	1.05
900	5.79	1.76	3.77	4.03	92.46	23.23	1.07	1.24	1.05
950	5.52	1.87	3.69	3.65	92.43	23.43	1.08	1.23	1.06
1000	5.27	1.99	3.63	3.28	92.46	23.75	1.09	1.22	1.07
1050	5.06	2.10	3.58	2.95	92.43	24.03	1.11	1.21	1.08
1100	4.86	2.22	3.54	2.63	92.43	24.33	1.12	1.19	1.10
1150	4.68	2.33	3.51	2.35	92.44	24.58	1.13	1.18	1.11
1200	4.53	2.45	3.49	2.09	92.47	24.77	1.14	1.17	1.13
1250	4.39	2.55	3.47	1.83	92.48	24.94	1.15	1.15	1.14
1300	4.26	2.66	3.46	1.60	92.53	24.91	1.16	1.14	1.15
1350	4.15	2.75	3.45	1.39	92.53	24.88	1.17	1.13	1.16
1400	4.05	2.85	3.45	1.20	92.59	24.70	1.18	1.12	1.17
1450	3.95	2.95	3.45	1.01	92.66	24.48	1.18	1.11	1.18
1500	3.88	3.03	3.46	0.85	92.72	24.05	1.20	1.11	1.19
1550	3.82	3.11	3.46	0.71	92.74	23.61	1.20	1.10	1.19
1600	3.76	3.18	3.47	0.58	92.79	23.19	1.21	1.10	1.19
1650	3.71	3.25	3.48	0.46	92.84	22.71	1.22	1.11	1.20
1700	3.67	3.31	3.49	0.36	92.94	22.26	1.22	1.11	1.20
1750	3.64	3.37	3.50	0.27	92.97	21.75	1.23	1.12	1.21
1800	3.62	3.41	3.51	0.21	93.04	21.29	1.23	1.14	1.21
1850	3.60	3.46	3.53	0.14	93.09	20.82	1.24	1.15	1.22
1900	3.60	3.49	3.54	0.11	93.10	20.41	1.24	1.17	1.22
1950	3.60	3.52	3.56	0.08	93.10	19.97	1.25	1.19	1.23
2000	3.60	3.55	3.57	0.05	93.16	19.53	1.25	1.21	1.23
2050	3.62	3.57	3.59	0.05	93.20	19.10	1.25	1.23	1.24
2100	3.65	3.58	3.61	0.07	93.20	18.67	1.26	1.25	1.25
2150	3.68	3.59	3.63	0.09	93.23	18.24	1.26	1.27	1.26
2200	3.72	3.58	3.65	0.14	93.11	17.86	1.27	1.30	1.27
2250	3.77	3.58	3.67	0.19	93.11	17.46	1.27	1.33	1.28
2300	3.82	3.57	3.69	0.25	93.04	17.10	1.28	1.35	1.29
2350	3.89	3.56	3.72	0.33	92.98	16.75	1.28	1.38	1.30
2400	3.96	3.54	3.75	0.42	92.92	16.42	1.29	1.41	1.31
2450	4.06	3.51	3.79	0.54	92.90	16.07	1.29	1.44	1.33
2500	4.14	3.48	3.81	0.66	92.72	15.79	1.29	1.47	1.34
2550	4.26	3.44	3.85	0.82	92.55	15.46	1.30	1.51	1.36
2600	4.36	3.40	3.88	0.96	92.43	15.13	1.31	1.55	1.37
2650	4.50	3.36	3.93	1.14	92.19	14.86	1.32	1.59	1.39
2700	4.66	3.32	3.99	1.34	92.02	14.52	1.32	1.63	1.40
2750	4.82	3.26	4.04	1.56	91.77	14.20	1.34	1.68	1.41
2800	5.01	3.22	4.12	1.79	91.56	13.86	1.34	1.73	1.42
2850	5.22	3.16	4.19	2.06	91.12	13.57	1.35	1.79	1.43
2900	5.44	3.11	4.27	2.33	90.82	13.20	1.35	1.84	1.43
2950	5.70	3.04	4.37	2.66	90.41	12.88	1.36	1.91	1.43
3000	5.98	2.96	4.47	3.01	89.62	12.62	1.37	1.98	1.44
3050	6.24	2.90	4.57	3.34	88.86	12.32	1.38	2.06	1.45
3100	6.56	2.83	4.70	3.73	88.24	12.04	1.38	2.14	1.45

¹ Total Loss = Insertion Loss+ 3dB Splitter Loss



2 Way-90° Power Splitter/Combiner

QBA-20W

Typical Performance Curves

Total Loss

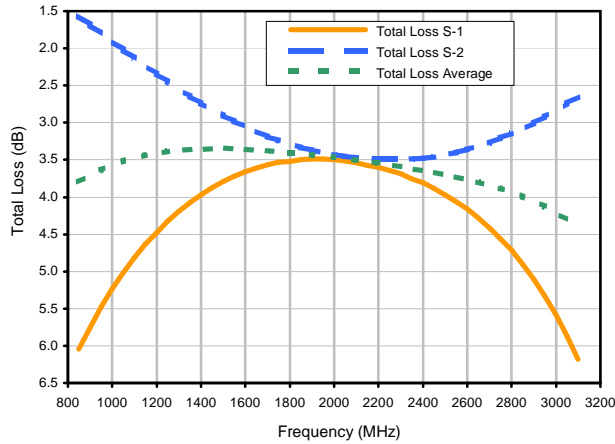

Average Total Loss vs. TEMPERATURE

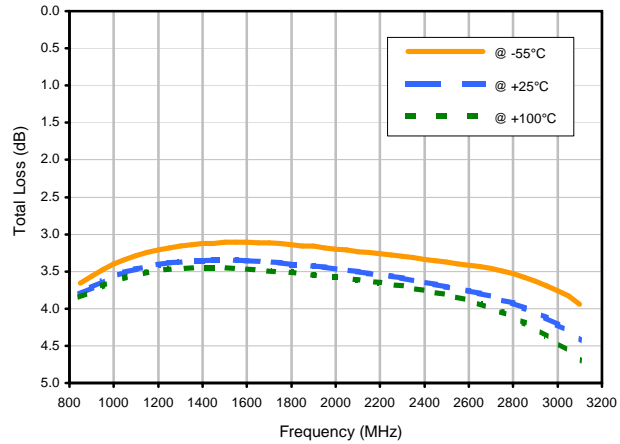

Amplitude Unbalance vs. TEMPERATURE

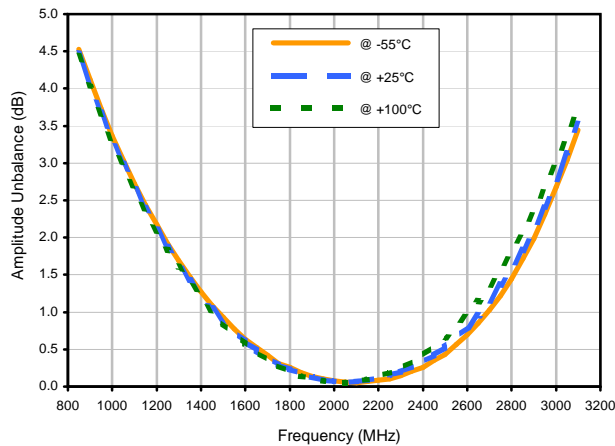

Phase Unbalance vs. TEMPERATURE

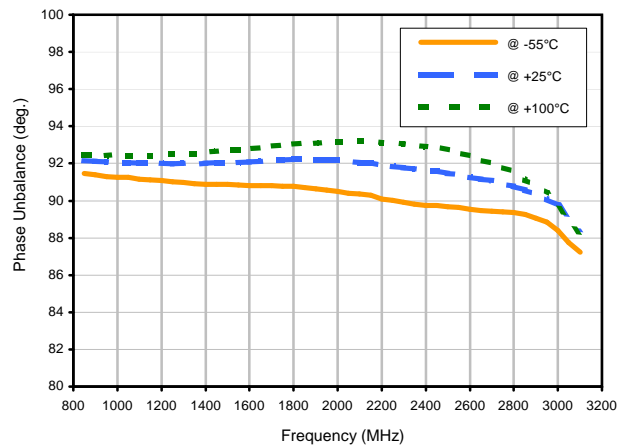

Isolation 1-2 vs. TEMPERATURE

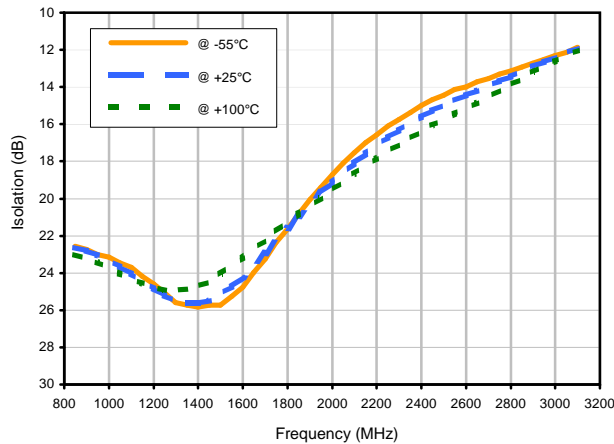

REV. X2
QBA-20W
100627
Page 1 of 2



IF/RF MICROWAVE COMPONENTS • ISO 9001 ISO 14001 AS 9100 CERTIFIED • RoHS compliant
P.O. Box 350166, Brooklyn, New York 11235-0006 (718) 934-4500 Fax (718) 332-4661

The Design Engineers Search Engine finds the model you need, Instantly • For detailed performance specs & shopping online see [minicircuits.com](http://www.minicircuits.com)

Typical Performance Curves

VSWR

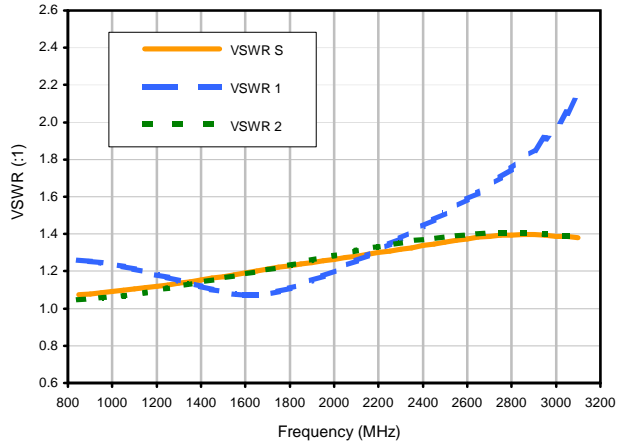

VSWR SUM vs. TEMPERATURE

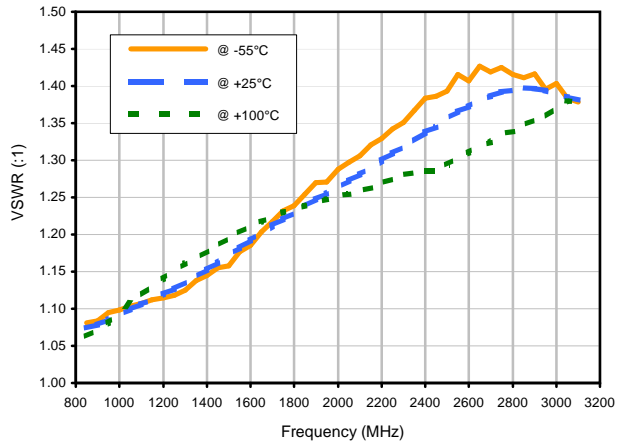

VSWR OUT1 vs. TEMPERATURE

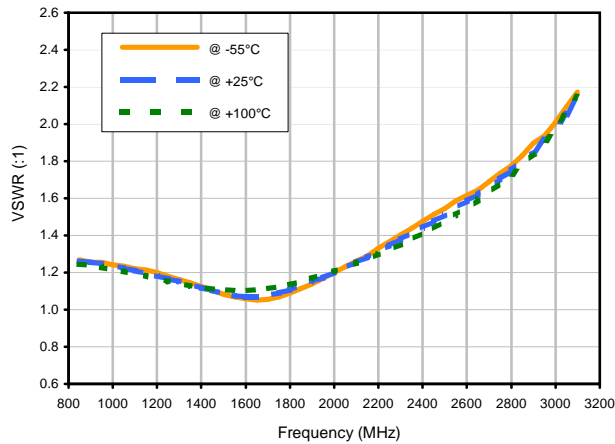

Case Style

SM33

SM33

Outline Dimensions

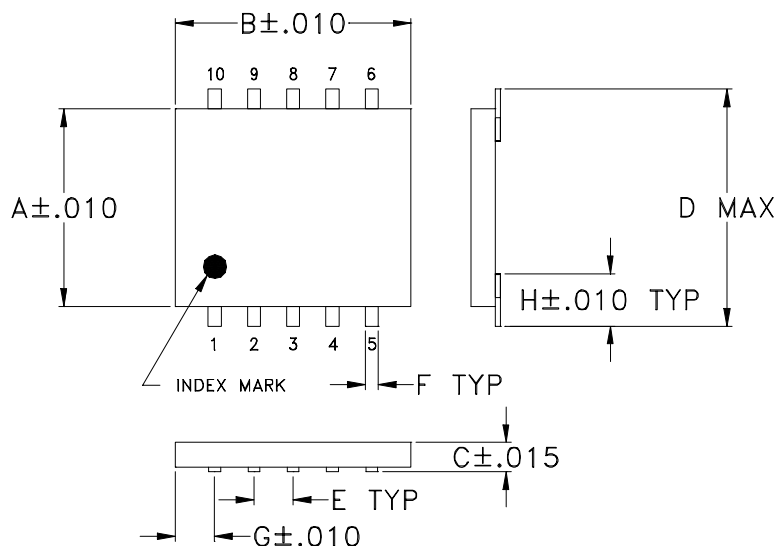

PCB Land Pattern

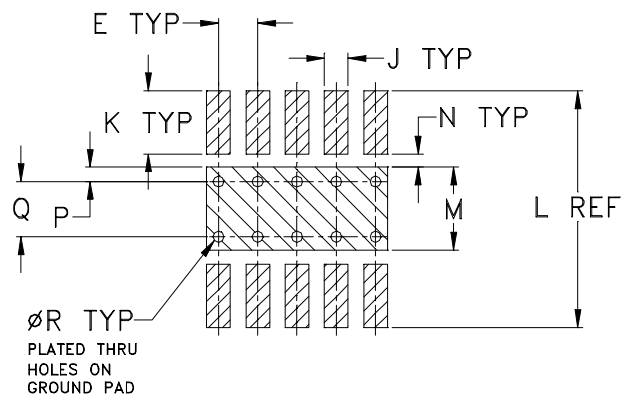

Suggested Layout,
Tolerance to be within $\pm .002$

ADJACENT GROUND PINS SHALL BE CONNECTED
TO EACH OTHER AND TO GROUND PAD

CASE #	A	B	C	D	E	F	G	H	J	K	L	M	N	P
SM33	.250 (6.35)	.300 (7.62)	.050 (1.27)	.310 (7.87)	.050 (1.27)	.015 (0.38)	.050 (1.27)	.066 (1.68)	.030 (0.76)	.095 (2.41)	.330 (8.38)	.100 (2.54)	.020 (0.51)	.015 (0.38)

CASE #	Q	R	WT. GRAM
SM33	.070 (1.78)	.014 (0.36)	0.2

Dimensions are in inches (mm). Tolerances: $\pm .005$

Notes:

- Case material: Ceramic.
- Termination finish:
For RoHS Case Styles: Tin plate.
For RoHS-5 Case Styles: Tin-Lead plate.



INTERNET <http://www.minicircuits.com>

P.O. Box 350166, Brooklyn, New York 11235-0003 (718) 934-4500 Fax (718) 332-4661

Distribution Centers NORTH AMERICA 800-654-7949 • 417-335-5935 • Fax 417-335-5945 • EUROPE 44-1252-832600 • Fax 44-1252-837010

Mini-Circuits ISO 9001 & ISO 14001 Certified

Tape & Reel Packaging TR-F34



Tape Width, mm	Device Cavity Pitch, mm	Reel Size, inches	Devices per Reel see note	
16	12	7	Small quantity standard (see note)	20
				50
				100
				200
		13	Standard	500
				1000

Note: Availability of small reel quantity varies by model.
Refer to pricing and availability on individual model dashboard.

Mini-Circuits carrier tape materials provide protection from ESD (Electro-Static Discharge) during handling and transportation. Tapes are static dissipative and comply with industry standards EIA-481/EIA-541.

Go to: www.minicircuits.com/pages/pdfs/tape.pdf



INTERNET <http://www.minicircuits.com>

P.O. Box 350166, Brooklyn, New York 11235-0003 (718) 934-4500 Fax (718) 332-4661

Distribution Centers NORTH AMERICA 800-654-7949 • 417-335-5935 • Fax 417-335-5945 • EUROPE 44-1252-832600 • Fax 44-1252-837010

Mini-Circuits ISO 9001 & ISO 14001 Certified

THIRD ANGLE PROJECTION

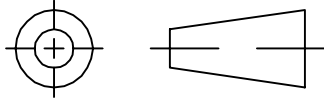

REVISIONS

REV	ECN No.	DESCRIPTION	DATE	DR	AUTH
A	M82377	UPDATED DRAWING	07/31/02	AV	DB
B	M101085	UPDATED DRAWING, ADDED DZ944 CASE STYLE & NOTE 2	10/06/05	MMG	HY
C	M102713	UPDATED NOTES	01/10/06	MMG	ABD

SUGGESTED MOUNTING CONFIGURATION FOR
SM1L/SM33/DZ944 CASE STYLES, "lf/nl" PIN CONNECTIONS

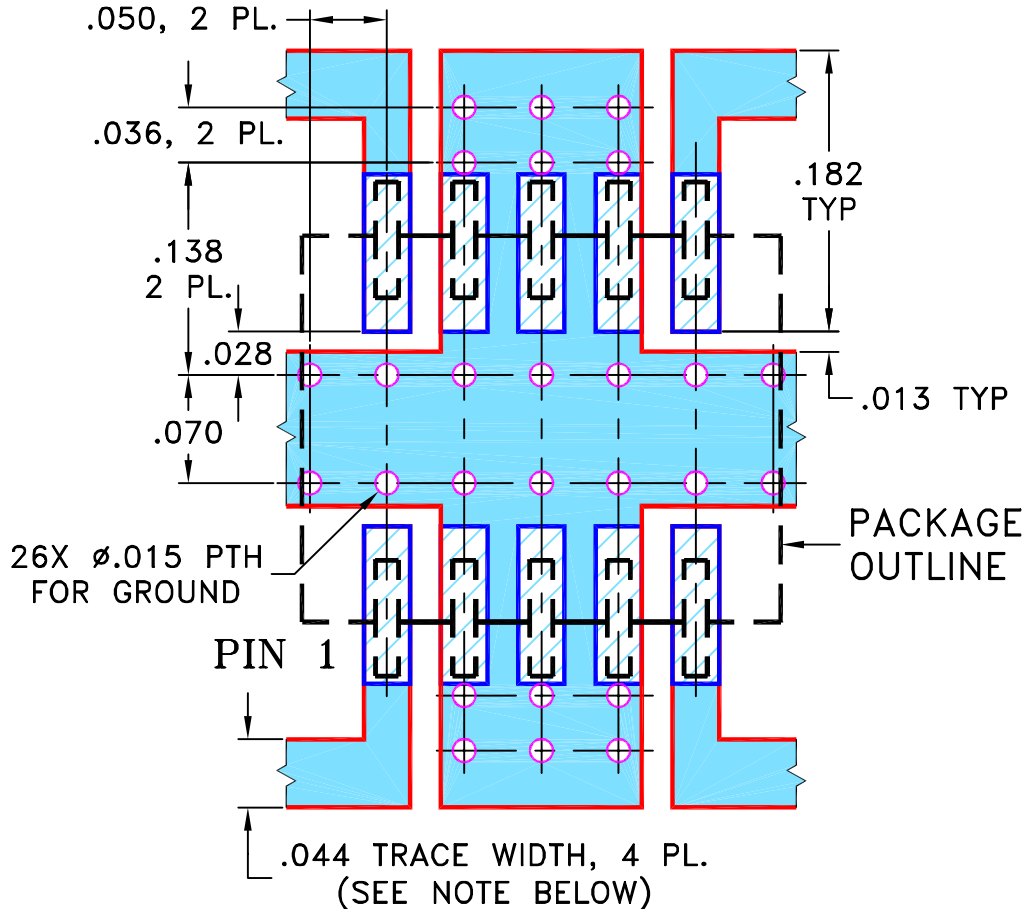

- NOTE: 1. TRACE WIDTH IS SHOWN FOR ROGERS RO4350B WITH DIELECTRIC THICKNESS $.020 \pm .0015$; COPPER: 1/2 OZ. EACH SIDE. FOR OTHER MATERIALS TRACE WIDTH MAY NEED TO BE MODIFIED.
2. BOTTOM SIDE OF THE PCB IS CONTINUOUS GROUND PLANE.

- DENOTES PCB COPPER LAYOUT WITH SMOBC (SOLDER MASK OVER BARE COPPER)
- DENOTES COPPER LAND PATTERN FREE OF SOLDER MASK

UNLESS OTHERWISE SPECIFIED	INITIALS	DATE
DIMENSIONS ARE IN INCHES	DRAWN MMG	04/12/00
TOLERANCES ON:	CHECKED WP	04/27/00
2 PL DECIMALS \pm	APPROVED DB	04/27/00
3 PL DECIMALS \pm .005		
ANGLES \pm		
FRACTIONS \pm		

Mini-Circuits[®] 13 Neptune Avenue
Brooklyn NY 11235

PL, lf/nl, SM1L/SM33/DZ944, BDCA/QBA, TB-115

SIZE A	CODE IDENT 15542	DRAWING NO: 98-PL-004	REV: C
FILE: 98PL004	SCALE: 8:1	SHEET: 1 OF 1	

Mini-Circuits[®]
THIS DOCUMENT AND ITS CONTENTS ARE THE PROPERTY OF MINI-CIRCUITS. EXCEPT FOR USE EXPRESSLY GRANTED, IN WRITING, TO ITS VENDORS, VENDEE AND THE UNITED STATES GOVERNMENT, MINI-CIRCUITS RESERVES ALL PROPRIETARY DESIGN, USE, MANUFACTURING AND REPRODUCTION RIGHTS THERETO. THESE CONTENTS SHALL NOT BE USED, DUPLICATED OR DISCLOSED TO ANY OUTSIDE PARTY, IN WHOLE OR IN PART, WITHOUT WRITTEN PERMISSION OF MINI-CIRCUITS.

Evaluation Board and Circuit

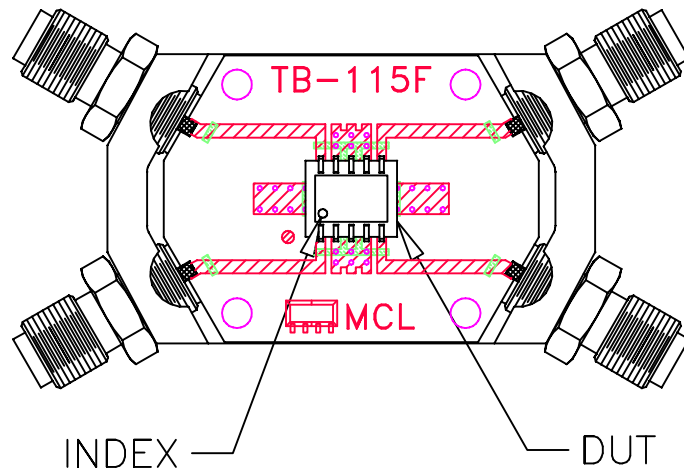

TB-115+

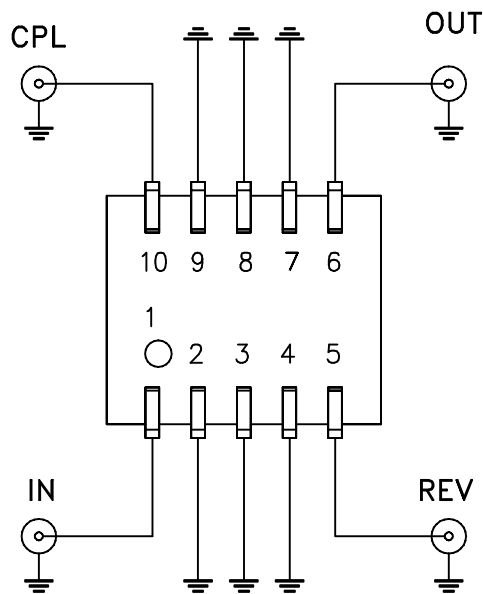

BDCA MODELS

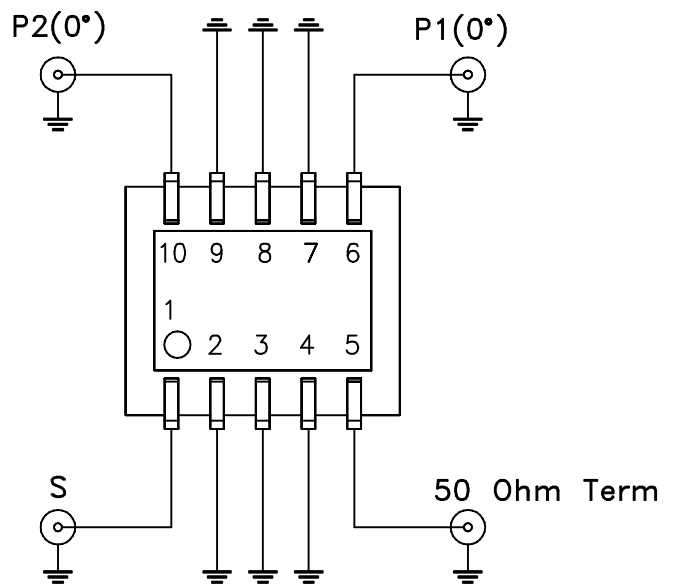

QBA MODELS

SCHEMATIC DIAGRAM

Notes:

1. SMA Female connectors.
2. PCB Material: Rogers R04350 or equivalent, Dielectric Constant=3.5, Thickness=.020 inch.

 **Mini-Circuits®**

All Mini-Circuits products are manufactured under exacting quality assurance and control standards, and are capable of meeting published specifications after being subjected to any or all of the following physical and environmental test.

Specification	Test/Inspection Condition	Reference/Spec
Operating Temperature	-55° to 100°C Ambient Environment	Individual Model Data Sheet
Storage Temperature	-55° to 100° C Ambient Environment	Individual Model Data Sheet
Humidity	90 to 95% RH, 240 hours, 50°C	MIL-STD-202, Method 103, Condition A, Except 50°C and end-point electrical test done within 12 hours
Thermal Shock	-55° to 100°C, 100 cycles	MIL-STD-202, Method 107, Condition A-3, except +100°C
Solder Reflow Heat	Sn-Pb Eutetic Process: 225°C peak Pb-Free Process 245° - 250°C peak	J-STD-020, Table 4-1, 4-2 and 5-2, Figure 5-1
Solderability	10X Magnification	J-STD-002, 95% Coverage
Vibration (High Frequency)	20g peak, 10-2000 Hz, 12 times in each of three perpendicular directions (total 36)	MIL-STD-202, Method 204, Condition D
Mechanical Shock	50g, 11 ms, 1/2-sine, 18 shocks: 3 each direction, each of 3 axes	MIL-STD-202, Method 213, Condition A
Marking Resistance to Solvents	Isopropyl alcohol + mineral spirits at 25°C; terpene defluxer at 25°C; distilled water + proylene glycol monomethyl ether + monoethanolamine at 63°C to 70°C	MIL-STD-202, Method 215