

# Surface Mount Power Splitter/Combiner

## QBA-24+ QBA-24

2 Way-90° 50Ω 1900 to 2400 MHz



Generic photo used for illustration purposes only

CASE STYLE: SM33

### Maximum Ratings

Operating Temperature	-55°C to 100°C
Storage Temperature	-55°C to 100°C

Permanent damage may occur if any of these limits are exceeded.

### Pin Connections

SUM PORT	1
PORT 1 (+90°)	10
PORT 2 (0°)	6
GROUND	2,3,4,7,8,9
50 OHM TERM EXTERNAL	5

### Outline Drawing

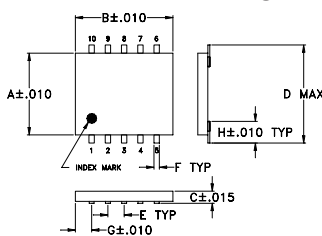

### PCB Land Pattern

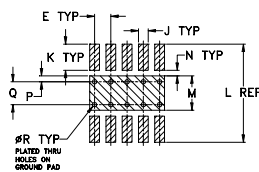

Suggested Layout,  
Tolerance to be within ±.002  
ADJACENT GROUND PINS SHALL BE CONNECTED TO EACH OTHER AND TO GROUND PAD

### Outline Dimensions (inch/mm)

A	B	C	D	E	F	G	H	
.250	.300	.050	.310	.050	.015	.050	.066	
6.35	7.62	1.27	7.87	1.27	0.38	1.27	1.68	
J	K	L	M	N	P	Q	R	wt
.030	.095	.330	.100	.020	.015	.070	.014	grams
0.76	2.41	8.38	2.54	0.51	0.38	1.78	0.36	0.2

### Demo Board MCL P/N: TB-115+ Suggested PCB Layout (PL-004)

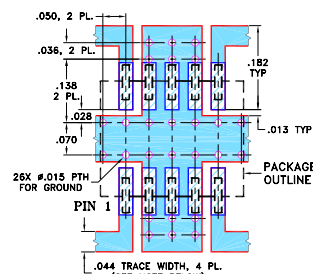

NOTE: 1. TRACE WIDTH IS SHOWN FOR ROGERS RO4550B WITH DIELECTRIC THICKNESS .020 ± .0015; COPPER: 1/2 OZ. EACH SIDE. FOR OTHER MATERIALS TRACE WIDTH MAY NEED TO BE MODIFIED.  
2. BOTTOM SIDE OF THE PCB IS CONTINUOUS GROUND PLANE.  
■ DENOTES PCB COPPER LAYOUT WITH SMOBC (SOLDER MASK OVER BARE COPPER)  
▨ DENOTES COPPER LAND PATTERN FREE OF SOLDER MASK

### Notes

A. Performance and quality attributes and conditions not expressly stated in this specification document are intended to be excluded and do not form a part of this specification document.  
B. Electrical specifications and performance data contained in this specification document are based on Mini-Circuit's applicable established test performance criteria and measurement instructions.  
C. The parts covered by this specification document are subject to Mini-Circuit's standard limited warranty and terms and conditions (collectively, "Standard Terms"); Purchasers of this part are entitled to the rights and benefits contained therein. For a full statement of the Standard Terms and the exclusive rights and remedies thereunder, please visit Mini-Circuit's website at [www.minicircuits.com/MCLStore/terms.jsp](http://www.minicircuits.com/MCLStore/terms.jsp)

### Features

- insertion loss, 0.55 dB typ.
- high power capability, 20W
- good isolation, 21 dB typ.
- ceramic body, good for heat dissipation
- solder plated leads for excellent solderability
- aqueous washable
- protected by U.S. Patent 5,534,830

### Applications

- DECT
- PHS
- satellite communications

### Electrical Specifications

FREQ. RANGE (MHz)	ISOLATION (dB)		INSERTION LOSS <sup>1</sup> (dB) Avg. of Coupled Outputs ABOVE 3 dB			PHASE UNBALANCE (Degrees)	AMPLITUDE UNBALANCE (dB)	INPUT POWER <sup>2</sup> (W)
	Typ.	Min.	$f_L$	$f_U$	$\sigma$			
$f_L$ - $f_U$			$\bar{X}$	$\bar{X}$	$\sigma$	Max.	Max.	below 25°C
1900-2400	21	17	0.54	0.71	0.02	6.0	0.8	20

1. Includes test fixture losses.  
2. Derate linearly to 4W at 100°C  
Thermal compound may be applied to decrease body temperature. See application note AN-10-007

### Typical Performance Data

Frequency (MHz)	Total Loss <sup>1</sup> (dB)		Amplitude Unbalance (dB)	Isolation (dB)	Phase Unbalance (deg.)	VSWR S	VSWR 1	VSWR 2
	S-1	S-2						
1700.00	3.86	3.14	0.72	23.07	87.86	1.19	1.24	1.20
1750.00	3.81	3.22	0.59	22.72	87.93	1.19	1.24	1.21
1800.00	3.77	3.27	0.50	22.77	87.90	1.19	1.24	1.21
1850.00	3.74	3.32	0.43	22.67	87.88	1.19	1.23	1.21
1900.00	3.71	3.38	0.32	22.17	87.77	1.19	1.23	1.21
1950.00	3.69	3.40	0.29	22.57	87.76	1.19	1.23	1.22
2000.00	3.69	3.47	0.22	21.77	87.70	1.19	1.22	1.22
2050.00	3.69	3.47	0.23	22.00	87.53	1.20	1.22	1.22
2100.00	3.69	3.52	0.17	21.55	87.48	1.19	1.22	1.21
2150.00	3.71	3.54	0.18	21.42	87.34	1.19	1.21	1.21
2200.00	3.72	3.52	0.20	21.21	87.47	1.19	1.21	1.21
2250.00	3.77	3.54	0.22	21.14	87.29	1.19	1.21	1.20
2300.00	3.79	3.54	0.24	20.76	87.39	1.19	1.20	1.20
2350.00	3.84	3.53	0.31	21.00	87.06	1.18	1.19	1.20
2400.00	3.89	3.55	0.34	20.42	87.13	1.19	1.20	1.20

1. Total Loss = Insertion Loss + 3dB splitter loss.

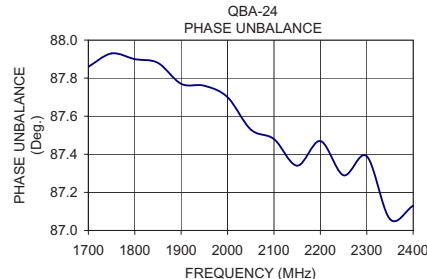
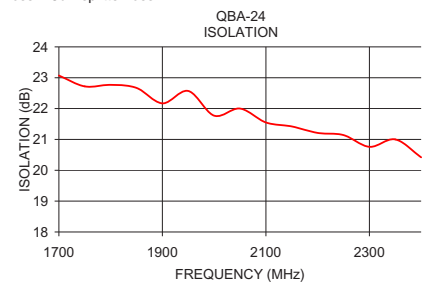
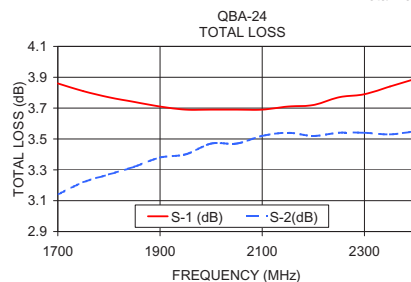

### electrical schematic

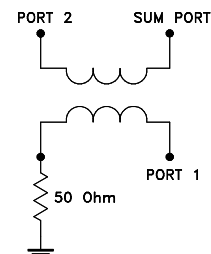

# 2 Way-90° Power Splitter/Combiner

# QBA-24+

## Typical Performance Data

TEST CONDITIONS: INPUT POWER = 0dBm @Temperature = +25°C

FREQ. (MHz)	TOTAL LOSS <sup>1</sup> (dB)			AMP. UNBAL. (dB)	PHASE UNBAL. From 90° (deg.)	ISOLATION (dB) 1-2	VSWR (:1)		
	S-1	S-2	AVG.				S	1	2
1000	5.62	1.75	3.68	3.87	1.09	22.01	1.10	1.31	1.08
1050	5.38	1.86	3.62	3.52	0.96	22.22	1.11	1.30	1.08
1100	5.17	1.96	3.56	3.20	0.84	22.46	1.11	1.30	1.09
1150	4.98	2.06	3.52	2.91	0.73	22.70	1.12	1.29	1.10
1200	4.79	2.17	3.48	2.62	0.63	23.01	1.13	1.28	1.10
1250	4.63	2.27	3.45	2.36	0.53	23.27	1.14	1.27	1.11
1300	4.49	2.36	3.42	2.12	0.44	23.57	1.15	1.26	1.12
1350	4.35	2.46	3.40	1.89	0.38	23.88	1.16	1.25	1.12
1400	4.23	2.56	3.39	1.67	0.28	24.11	1.17	1.24	1.13
1450	4.12	2.64	3.38	1.48	0.23	24.31	1.18	1.23	1.14
1500	4.02	2.73	3.38	1.29	0.15	24.42	1.19	1.21	1.15
1550	3.93	2.81	3.37	1.12	0.11	24.43	1.20	1.20	1.16
1600	3.85	2.89	3.37	0.97	0.05	24.33	1.21	1.19	1.17
1650	3.79	2.96	3.38	0.82	0.00	24.11	1.22	1.19	1.18
1700	3.73	3.03	3.38	0.70	0.05	23.78	1.23	1.18	1.19
1750	3.68	3.10	3.39	0.58	0.09	23.39	1.24	1.18	1.20
1800	3.63	3.16	3.40	0.47	0.13	22.92	1.25	1.18	1.21
1850	3.60	3.21	3.40	0.39	0.18	22.40	1.26	1.18	1.22
1900	3.57	3.27	3.42	0.30	0.26	21.89	1.28	1.18	1.23
1925	3.56	3.29	3.43	0.27	0.28	21.62	1.28	1.19	1.23
1950	3.55	3.32	3.43	0.23	0.32	21.34	1.29	1.19	1.24
1975	3.54	3.34	3.44	0.20	0.33	21.10	1.29	1.20	1.24
2000	3.54	3.36	3.45	0.18	0.33	20.86	1.30	1.20	1.25
2025	3.54	3.38	3.46	0.16	0.36	20.61	1.30	1.21	1.25
2050	3.53	3.40	3.47	0.13	0.40	20.36	1.31	1.21	1.25
2075	3.53	3.41	3.47	0.12	0.45	20.12	1.31	1.22	1.26
2100	3.53	3.43	3.48	0.10	0.50	19.87	1.32	1.23	1.26
2125	3.53	3.45	3.49	0.08	0.52	19.68	1.32	1.23	1.26
2150	3.53	3.45	3.49	0.08	0.53	19.43	1.33	1.24	1.27
2175	3.54	3.47	3.50	0.07	0.59	19.23	1.33	1.25	1.27
2200	3.54	3.48	3.51	0.06	0.59	19.02	1.34	1.26	1.27
2300	3.58	3.52	3.55	0.06	0.72	18.21	1.35	1.30	1.29
2400	3.65	3.52	3.59	0.13	0.85	17.47	1.37	1.34	1.30
2500	3.75	3.51	3.63	0.24	0.97	16.81	1.38	1.38	1.31
2600	3.86	3.48	3.67	0.39	1.12	16.23	1.39	1.42	1.31
2700	4.03	3.41	3.72	0.62	1.24	15.71	1.40	1.47	1.32
2800	4.22	3.31	3.77	0.91	1.41	15.20	1.40	1.52	1.32
2900	4.45	3.19	3.82	1.26	1.74	14.72	1.40	1.58	1.32
3000	4.76	3.05	3.91	1.71	2.02	14.18	1.39	1.65	1.32

<sup>1</sup> Total Loss = Insertion Loss+ 3dB Splitter Loss

# 2 Way-90° Power Splitter/Combiner

# QBA-24+

## Typical Performance Data

TEST CONDITIONS: INPUT POWER = 0dBm @Temperature = -55°C

FREQ. (MHz)	TOTAL LOSS <sup>1</sup> (dB)			AMP. UNBAL. (dB)	PHASE UNBAL. From 90° (deg.)	ISOLATION (dB) 1-2	VSWR		
	S-1	S-2	AVG.				S	(:1) 1	2
1000	5.46	1.58	3.52	3.88	2.22	21.74	1.11	1.32	1.08
1050	5.22	1.68	3.45	3.54	2.18	21.96	1.12	1.32	1.09
1100	5.00	1.77	3.38	3.24	2.10	22.11	1.12	1.32	1.09
1150	4.81	1.87	3.34	2.94	2.05	22.42	1.12	1.31	1.10
1200	4.61	1.96	3.29	2.65	2.01	22.75	1.13	1.30	1.10
1250	4.44	2.05	3.25	2.39	1.97	23.06	1.13	1.29	1.10
1300	4.29	2.14	3.22	2.15	1.90	23.61	1.14	1.27	1.11
1350	4.15	2.23	3.19	1.92	1.88	23.87	1.15	1.26	1.11
1400	4.02	2.32	3.17	1.70	1.84	24.29	1.16	1.24	1.12
1450	3.90	2.40	3.15	1.50	1.83	24.44	1.17	1.22	1.13
1500	3.79	2.49	3.14	1.31	1.82	24.83	1.17	1.21	1.15
1550	3.70	2.57	3.13	1.13	1.84	24.90	1.18	1.20	1.16
1600	3.61	2.63	3.12	0.98	1.86	24.91	1.19	1.18	1.17
1650	3.54	2.70	3.12	0.83	1.84	24.65	1.21	1.17	1.18
1700	3.47	2.76	3.12	0.71	1.84	24.27	1.22	1.15	1.20
1750	3.41	2.83	3.12	0.58	1.88	23.72	1.23	1.15	1.21
1800	3.37	2.89	3.13	0.48	1.89	23.15	1.25	1.15	1.23
1850	3.33	2.94	3.13	0.39	1.90	22.52	1.26	1.16	1.24
1900	3.30	3.00	3.15	0.30	1.91	21.70	1.29	1.17	1.25
1925	3.29	3.02	3.16	0.27	1.90	21.44	1.29	1.18	1.26
1950	3.28	3.05	3.16	0.23	1.89	21.16	1.30	1.19	1.26
1975	3.28	3.07	3.17	0.20	1.87	20.87	1.31	1.19	1.27
2000	3.27	3.10	3.18	0.17	1.90	20.48	1.33	1.21	1.28
2025	3.26	3.12	3.19	0.14	1.87	20.14	1.33	1.22	1.29
2050	3.27	3.14	3.21	0.12	1.96	19.82	1.33	1.23	1.29
2075	3.26	3.15	3.21	0.11	1.90	19.60	1.34	1.24	1.29
2100	3.26	3.17	3.22	0.09	1.86	19.29	1.36	1.25	1.29
2125	3.26	3.19	3.22	0.07	1.85	19.00	1.37	1.26	1.30
2150	3.26	3.20	3.23	0.06	1.85	18.77	1.37	1.27	1.30
2175	3.26	3.22	3.24	0.04	1.84	18.53	1.38	1.29	1.31
2200	3.26	3.23	3.25	0.03	1.86	18.29	1.39	1.30	1.31
2300	3.30	3.26	3.28	0.04	1.80	17.43	1.42	1.35	1.32
2400	3.36	3.28	3.32	0.08	1.82	16.59	1.45	1.40	1.32
2500	3.43	3.26	3.35	0.16	1.89	16.02	1.45	1.44	1.32
2600	3.50	3.21	3.35	0.29	1.97	15.59	1.44	1.47	1.32
2700	3.63	3.14	3.39	0.50	2.14	15.16	1.44	1.50	1.31
2800	3.79	3.01	3.40	0.78	2.10	14.81	1.43	1.54	1.31
2900	3.97	2.87	3.42	1.10	2.19	14.44	1.41	1.57	1.31
3000	4.23	2.71	3.47	1.52	2.11	14.13	1.39	1.64	1.31

<sup>1</sup> Total Loss = Insertion Loss+ 3dB Splitter Loss

# 2 Way-90° Power Splitter/Combiner

# QBA-24+

## Typical Performance Data

TEST CONDITIONS: INPUT POWER = 0dBm @Temperature = +100°C

FREQ. (MHz)	TOTAL LOSS <sup>1</sup> (dB)			AMP. UNBAL. (dB)	PHASE UNBAL. From 90° (deg.)	ISOLATION (dB) 1-2	VSWR (:1)		
	S-1	S-2	AVG.				S	1	2
1000	5.66	1.85	3.75	3.81	0.42	22.41	1.09	1.29	1.09
1050	5.43	1.95	3.69	3.48	0.60	22.58	1.10	1.28	1.10
1100	5.22	2.06	3.64	3.16	0.79	22.77	1.12	1.27	1.10
1150	5.04	2.18	3.61	2.86	0.97	22.90	1.14	1.27	1.12
1200	4.86	2.29	3.58	2.57	1.13	23.07	1.15	1.26	1.12
1250	4.70	2.39	3.55	2.31	1.27	23.21	1.16	1.25	1.13
1300	4.57	2.50	3.54	2.07	1.40	23.32	1.18	1.25	1.14
1350	4.44	2.60	3.52	1.84	1.52	23.42	1.19	1.24	1.15
1400	4.33	2.70	3.51	1.63	1.67	23.52	1.20	1.24	1.16
1450	4.22	2.79	3.51	1.43	1.78	23.58	1.21	1.24	1.17
1500	4.14	2.88	3.51	1.26	1.94	23.56	1.23	1.24	1.18
1550	4.05	2.97	3.51	1.09	2.02	23.43	1.24	1.23	1.18
1600	3.98	3.05	3.51	0.94	2.16	23.31	1.25	1.23	1.19
1650	3.93	3.12	3.53	0.80	2.28	23.11	1.26	1.23	1.19
1700	3.87	3.19	3.53	0.67	2.41	22.87	1.26	1.23	1.19
1750	3.82	3.25	3.53	0.57	2.54	22.62	1.27	1.23	1.20
1800	3.78	3.32	3.55	0.46	2.69	22.31	1.28	1.23	1.20
1850	3.75	3.37	3.56	0.38	2.80	21.93	1.29	1.23	1.20
1900	3.72	3.43	3.57	0.29	2.92	21.63	1.29	1.23	1.21
1925	3.71	3.45	3.58	0.26	2.98	21.49	1.29	1.23	1.21
1950	3.70	3.47	3.58	0.23	3.06	21.32	1.29	1.23	1.21
1975	3.69	3.48	3.59	0.21	3.11	21.17	1.30	1.23	1.21
2000	3.68	3.51	3.60	0.18	3.14	21.03	1.30	1.23	1.21
2025	3.68	3.52	3.60	0.16	3.25	20.87	1.30	1.23	1.21
2050	3.69	3.55	3.62	0.14	3.25	20.70	1.30	1.23	1.21
2075	3.68	3.56	3.62	0.12	3.36	20.55	1.30	1.24	1.21
2100	3.68	3.57	3.63	0.11	3.43	20.37	1.31	1.24	1.22
2125	3.68	3.59	3.63	0.09	3.50	20.22	1.31	1.24	1.22
2150	3.68	3.59	3.63	0.09	3.55	20.09	1.30	1.24	1.22
2175	3.68	3.60	3.64	0.08	3.64	19.97	1.30	1.24	1.22
2200	3.69	3.61	3.65	0.08	3.60	19.78	1.30	1.24	1.22
2300	3.73	3.63	3.68	0.10	3.89	19.13	1.30	1.26	1.23
2400	3.81	3.61	3.71	0.20	4.13	18.52	1.29	1.28	1.25
2500	3.92	3.59	3.75	0.33	4.38	17.85	1.29	1.32	1.26
2600	4.05	3.55	3.80	0.51	4.69	17.19	1.30	1.36	1.28
2700	4.24	3.50	3.87	0.75	5.10	16.54	1.30	1.42	1.30
2800	4.48	3.40	3.94	1.08	5.69	15.87	1.32	1.49	1.32
2900	4.76	3.31	4.03	1.45	6.30	15.16	1.33	1.56	1.33
3000	5.09	3.20	4.14	1.90	7.20	14.48	1.35	1.65	1.34

<sup>1</sup>Total Loss = Insertion Loss+ 3dB Splitter Loss

# 2 Way-90° Power Splitter/Combiner

QBA-24+

## Typical Performance Curves

**Total Loss**

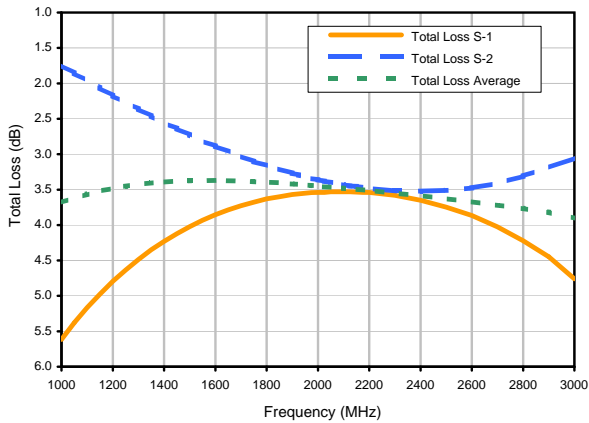

**Average Total Loss vs. TEMPERATURE**

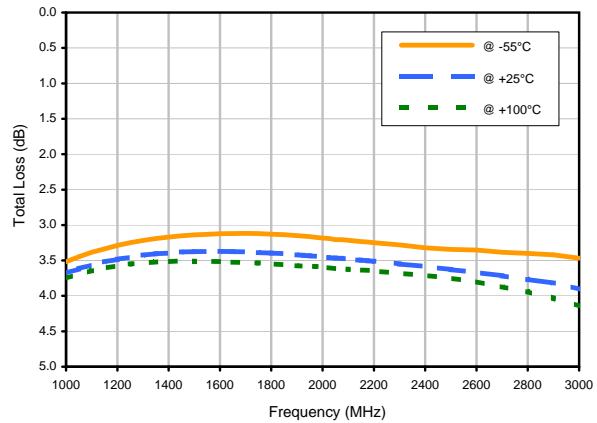

**Amplitude Unbalance vs. TEMPERATURE**

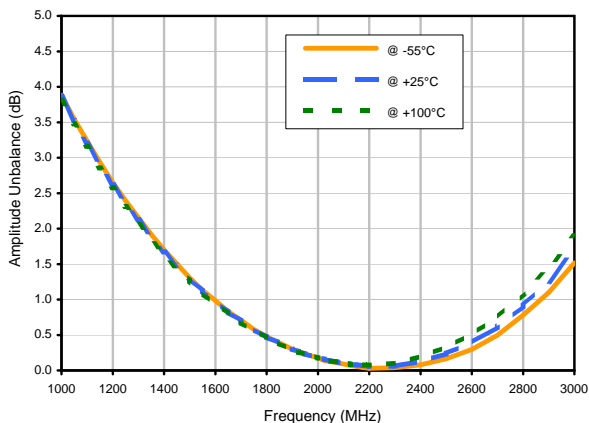

**Phase Unbalance vs. TEMPERATURE**

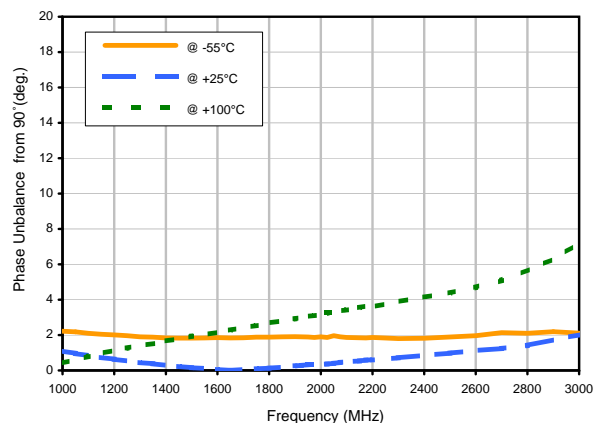

**Isolation 1-2 vs. TEMPERATURE**

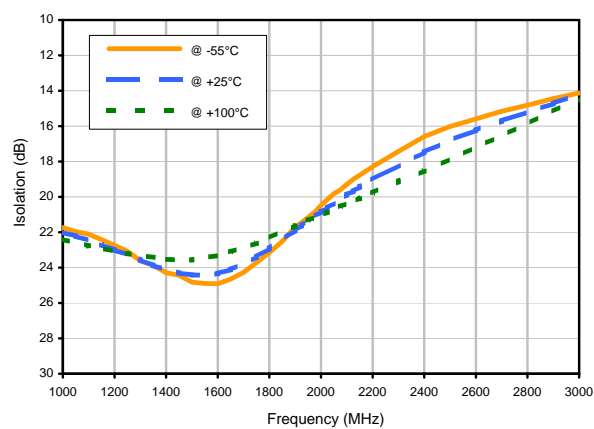

REV. X2  
QBA-24+  
100627  
Page 1 of 2



IF/RF MICROWAVE COMPONENTS • ISO 9001 ISO 14001 AS9100 CERTIFIED • RoHS compliant  
P.O. Box 350166, Brooklyn, New York 11235-0003 (718) 934-4500 Fax (718) 332-4661



The Design Engineers Search Engine finds the model you need, Instantly • For detailed performance specs & shopping online see



# 2 Way-90° Power Splitter/Combiner

# QBA-24+

## Typical Performance Curves

### VSWR

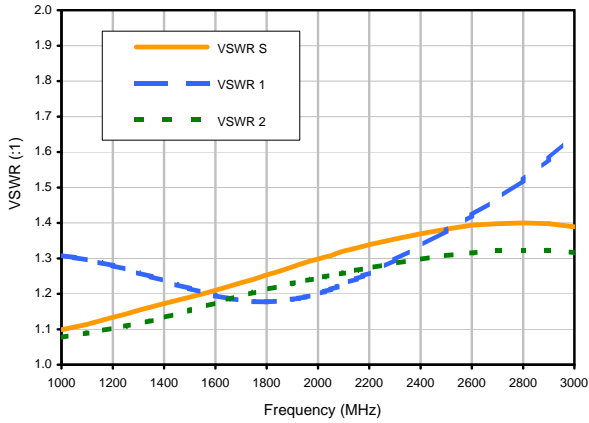

### VSWR SUM vs. TEMPERATURE

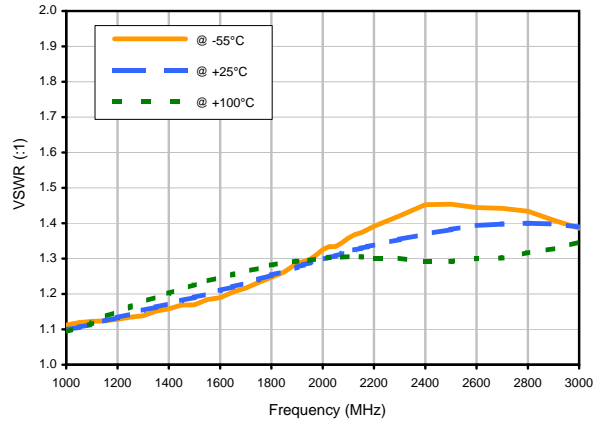

### VSWR OUT1 vs. TEMPERATURE

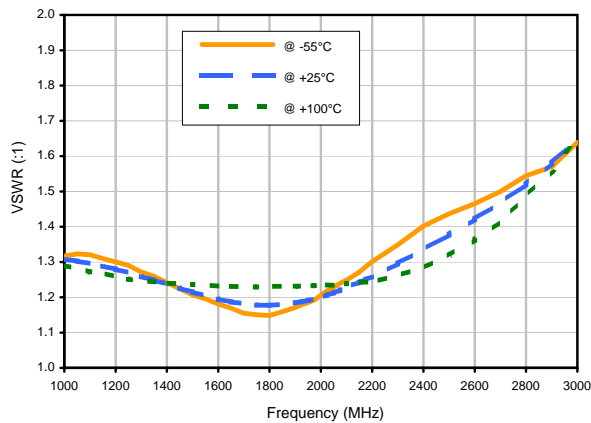

REV. X2  
QBA-24+  
100627  
Page 2 of 2

# Case Style

# SM33

SM33

## Outline Dimensions

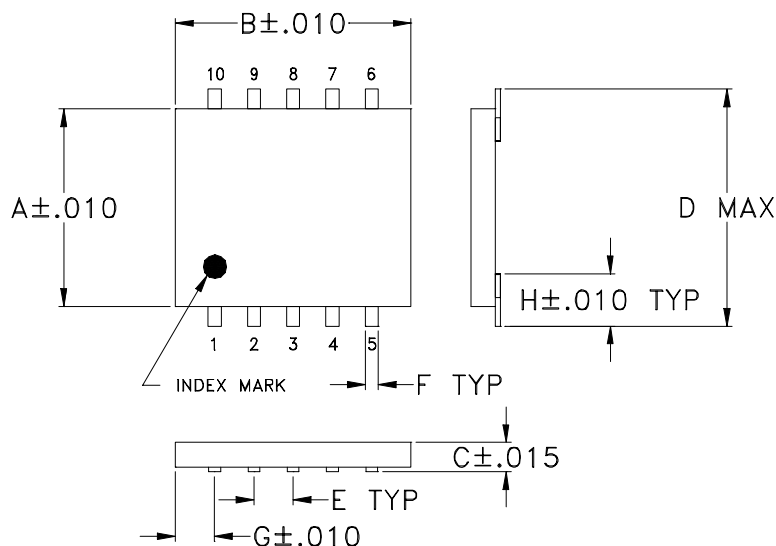

## PCB Land Pattern

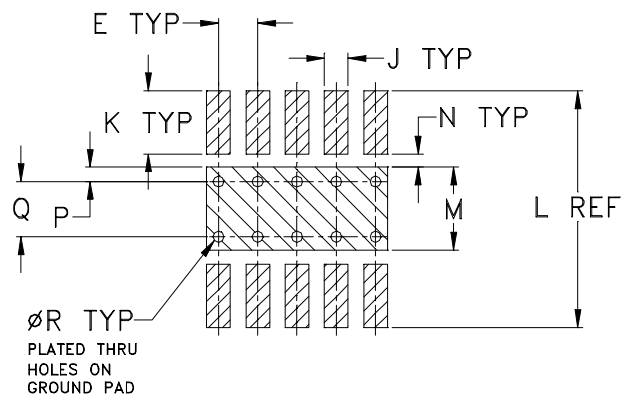

Suggested Layout,  
Tolerance to be within  $\pm .002$

ADJACENT GROUND PINS SHALL BE CONNECTED  
TO EACH OTHER AND TO GROUND PAD

CASE #	A	B	C	D	E	F	G	H	J	K	L	M	N	P
SM33	.250 (6.35)	.300 (7.62)	.050 (1.27)	.310 (7.87)	.050 (1.27)	.015 (0.38)	.050 (1.27)	.066 (1.68)	.030 (0.76)	.095 (2.41)	.330 (8.38)	.100 (2.54)	.020 (0.51)	.015 (0.38)

CASE #	Q	R	WT. GRAM
SM33	.070 (1.78)	.014 (0.36)	0.2

Dimensions are in inches (mm). Tolerances:  $\pm .005$

### Notes:

- Case material: Ceramic.
- Termination finish:  
For RoHS Case Styles: Tin plate.  
For RoHS-5 Case Styles: Tin-Lead plate.



INTERNET <http://www.minicircuits.com>

P.O. Box 350166, Brooklyn, New York 11235-0003 (718) 934-4500 Fax (718) 332-4661

Distribution Centers NORTH AMERICA 800-654-7949 • 417-335-5935 • Fax 417-335-5945 • EUROPE 44-1252-832600 • Fax 44-1252-837010

Mini-Circuits ISO 9001 & ISO 14001 Certified

# Tape & Reel Packaging TR-F34



Tape Width, mm	Device Cavity Pitch, mm	Reel Size, inches	Devices per Reel see note	
16	12	7	Small quantity standard (see note)	20
				50
				100
				200
		13	Standard	500
				1000

Note: Availability of small reel quantity varies by model.  
Refer to pricing and availability on individual model dashboard.

Mini-Circuits carrier tape materials provide protection from ESD (Electro-Static Discharge) during handling and transportation. Tapes are static dissipative and comply with industry standards EIA-481/EIA-541.

Go to: [www.minicircuits.com/pages/pdfs/tape.pdf](http://www.minicircuits.com/pages/pdfs/tape.pdf)



INTERNET <http://www.minicircuits.com>

P.O. Box 350166, Brooklyn, New York 11235-0003 (718) 934-4500 Fax (718) 332-4661

Distribution Centers NORTH AMERICA 800-654-7949 • 417-335-5935 • Fax 417-335-5945 • EUROPE 44-1252-832600 • Fax 44-1252-837010

Mini-Circuits ISO 9001 & ISO 14001 Certified

THIRD ANGLE PROJECTION

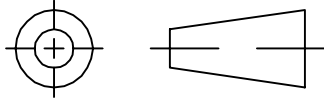

REVISIONS

REV	ECN No.	DESCRIPTION	DATE	DR	AUTH
A	M82377	UPDATED DRAWING	07/31/02	AV	DB
B	M101085	UPDATED DRAWING, ADDED DZ944 CASE STYLE & NOTE 2	10/06/05	MMG	HY
C	M102713	UPDATED NOTES	01/10/06	MMG	ABD

SUGGESTED MOUNTING CONFIGURATION FOR  
SM1L/SM33/DZ944 CASE STYLES, "lf/nl" PIN CONNECTIONS

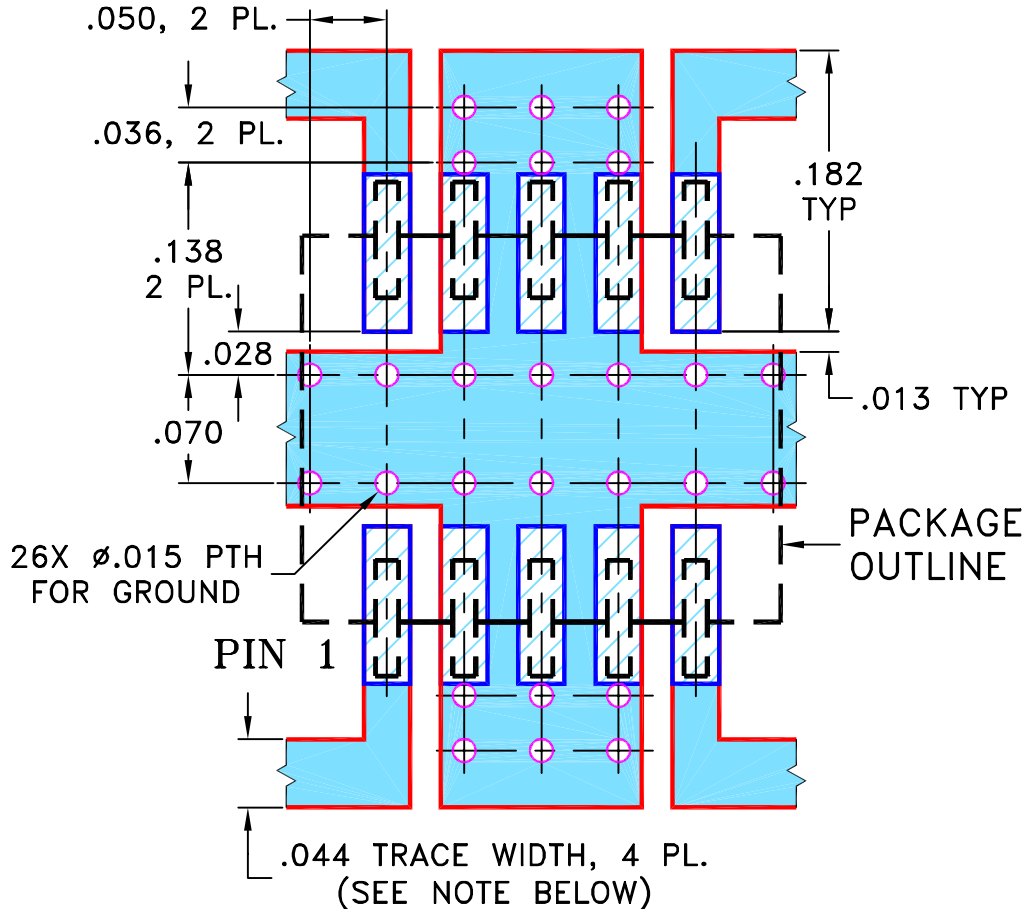

- NOTE: 1. TRACE WIDTH IS SHOWN FOR ROGERS RO4350B WITH DIELECTRIC THICKNESS  $.020 \pm .0015$ ; COPPER: 1/2 OZ. EACH SIDE. FOR OTHER MATERIALS TRACE WIDTH MAY NEED TO BE MODIFIED.  
2. BOTTOM SIDE OF THE PCB IS CONTINUOUS GROUND PLANE.

- DENOTES PCB COPPER LAYOUT WITH SMOBC (SOLDER MASK OVER BARE COPPER)
- DENOTES COPPER LAND PATTERN FREE OF SOLDER MASK

UNLESS OTHERWISE SPECIFIED	INITIALS	DATE
DIMENSIONS ARE IN INCHES	DRAWN <b>MMG</b>	04/12/00
TOLERANCES ON:	CHECKED <b>WP</b>	04/27/00
2 PL DECIMALS $\pm$	APPROVED <b>DB</b>	04/27/00
3 PL DECIMALS $\pm$ .005		
ANGLES $\pm$		
FRACTIONS $\pm$		

**Mini-Circuits**<sup>®</sup> 13 Neptune Avenue  
Brooklyn NY 11235

PL, lf/nl, SM1L/SM33/DZ944, BDCA/QBA, TB-115

Mini-Circuits<sup>®</sup>  
THIS DOCUMENT AND ITS CONTENTS ARE THE PROPERTY OF MINI-CIRCUITS. EXCEPT FOR USE EXPRESSLY GRANTED, IN WRITING, TO ITS VENDORS, VENDEE AND THE UNITED STATES GOVERNMENT, MINI-CIRCUITS RESERVES ALL PROPRIETARY DESIGN, USE, MANUFACTURING AND REPRODUCTION RIGHTS THERETO. THESE CONTENTS SHALL NOT BE USED, DUPLICATED OR DISCLOSED TO ANY OUTSIDE PARTY, IN WHOLE OR IN PART, WITHOUT WRITTEN PERMISSION OF MINI-CIRCUITS.

SIZE <b>A</b>	CODE IDENT <b>15542</b>	DRAWING NO: <b>98-PL-004</b>	REV: <b>C</b>
FILE: <b>98PL004</b>	SCALE: <b>8:1</b>	SHEET: <b>1 OF 1</b>	

# Evaluation Board and Circuit

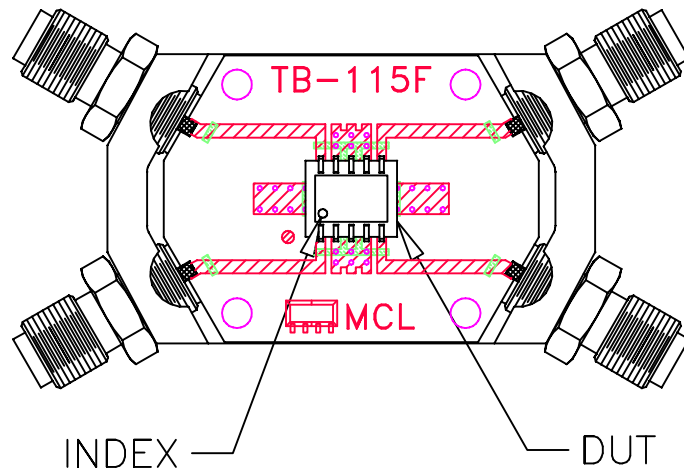

TB-115+

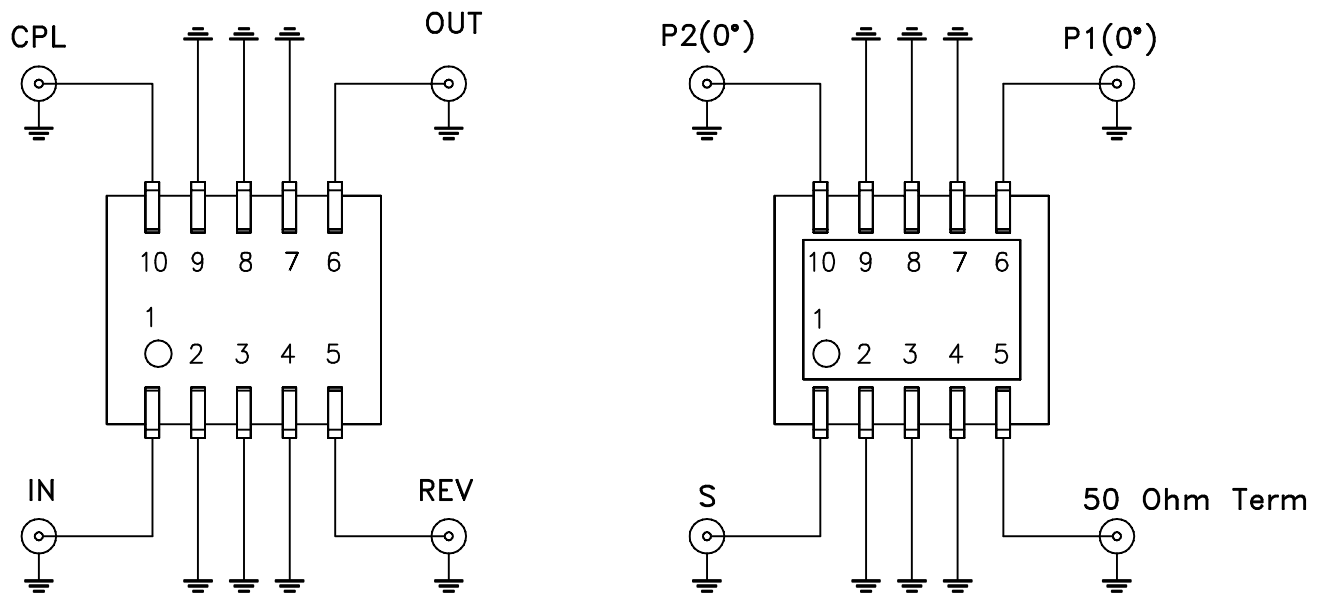

BDCA MODELS

QBA MODELS

## SCHEMATIC DIAGRAM

### Notes:

1. SMA Female connectors.
2. PCB Material: Rogers R04350 or equivalent, Dielectric Constant=3.5, Thickness=.020 inch.



All Mini-Circuits products are manufactured under exacting quality assurance and control standards, and are capable of meeting published specifications after being subjected to any or all of the following physical and environmental test.

Specification	Test/Inspection Condition	Reference/Spec
Operating Temperature	-55° to 100°C Ambient Environment	Individual Model Data Sheet
Storage Temperature	-55° to 100° C Ambient Environment	Individual Model Data Sheet
Humidity	90 to 95% RH, 240 hours, 50°C	MIL-STD-202, Method 103, Condition A, Except 50°C and end-point electrical test done within 12 hours
Thermal Shock	-55° to 100°C, 100 cycles	MIL-STD-202, Method 107, Condition A-3, except +100°C
Solder Reflow Heat	Sn-Pb Eutetic Process: 225°C peak Pb-Free Process 245° - 250°C peak	J-STD-020, Table 4-1, 4-2 and 5-2, Figure 5-1
Solderability	10X Magnification	J-STD-002, 95% Coverage
Vibration (High Frequency)	20g peak, 10-2000 Hz, 12 times in each of three perpendicular directions (total 36)	MIL-STD-202, Method 204, Condition D
Mechanical Shock	50g, 11 ms, 1/2-sine, 18 shocks: 3 each direction, each of 3 axes	MIL-STD-202, Method 213, Condition A
Marking Resistance to Solvents	Isopropyl alcohol + mineral spirits at 25°C; terpene defluxer at 25°C; distilled water + proylene glycol monomethyl ether + monoethanolamine at 63°C to 70°C	MIL-STD-202, Method 215