

2 Way-90° Power Splitter

QCS-312+

50Ω 1700 to 3100 MHz

The Big Deal

- High Power handling (15W)
- Low Unbalance, 0.5 dB & 4 deg. typ.
- Industry leading combination of size/bandwidth



CASE STYLE: GE0805C-1

Product Overview

Mini-Circuits new 90° Power Splitter, model: QCS-312+, offers an industry leading combination of operating bandwidth and size; supporting nearly an octave band in a miniature EIA-0805 form factor. The outstanding phase and amplitude unbalance make this component a versatile building block for use in a variety of systems and sub-system designs.

Key Features

Feature	Advantages
Small Size	Offered in the EIA-0805 package size, the QCS-312+ offers an industry leading combination of size, bandwidth and frequency. The small footprint (2.0mm x 1.25mm) allows for reduced parasitics in systems with improved performance and simplified layout.
Low Phase and Amplitude Unbalance	Supporting 4 deg. and 0.5 dB unbalance make this 90° hybrid applicable for use in higher level integrated components such as image reject mixers, single sideband modulators, phase shifters, variable attenuators, and balance amplifiers.
High Power Handling	Capable of operating up to 15W, the LTCC construction of the QCS-312+ makes this 90° hybrid a robust, rugged product that can be used effectively in either the transmit or receive paths.

Notes

- A. Performance and quality attributes and conditions not expressly stated in this specification document are intended to be excluded and do not form a part of this specification document.
B. Electrical specifications and performance data contained in this specification document are based on Mini-Circuit's applicable established test performance criteria and measurement instructions.
C. The parts covered by this specification document are subject to Mini-Circuits standard limited warranty and terms and conditions (collectively, "Standard Terms"); Purchasers of this part are entitled to the rights and benefits contained therein. For a full statement of the Standard Terms and the exclusive rights and remedies thereunder, please visit Mini-Circuits' website at www.minicircuits.com/MCLStore/terms.jsp



Power Splitter/Combiner

QCS-312+

2 Way-90° 50Ω 1700 to 3100 MHz



Generic photo used for illustration purposes only

CASE STYLE: GE0805C-1

+RoHS Compliant

The +Suffix identifies RoHS Compliance. See our web site for RoHS Compliance methodologies and qualifications



Available Tape and Reel at no extra cost

Reel Size	Devices/Reel
7"	20, 50, 100, 200, 500, 1000, 2000

Maximum Ratings

Operating Temperature	-55°C to 100°C
Storage Temperature	-55°C to 100°C
Power Input (as a splitter)	15W* max.

*Derate linearly to 7W at 100°C ambient.

Permanent damage may occur if any of these limits are exceeded.

Pin Connections

SUM PORT	1
PORT 1 (0°)	4
PORT 2 (+90°)	6
GROUND	2,5
50 OHM TERM EXTERNAL	3

Outline Drawing

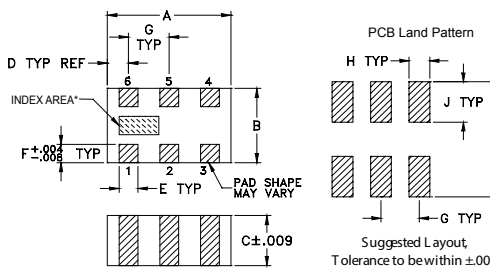

Outline Dimensions (inch/mm)

A	B	C	D	E	F
.079	.049	.033	.014	.012	.012
2.01	1.24	0.84	0.36	0.30	0.30
G	H	J	K		wt
.026	.014	.039	.110		grams
0.66	0.36	1.00	2.80		.008

Features

- Low insertion loss, 0.5 dB typ.
- High isolation, 25 dB typ.
- Miniature size, 0.079"x0.049"x0.033"
- LTCC construction
- High power

Applications

- Balanced amplifiers
- Modulators
- DCS, PCS, UMTS
- ISM
- WiMAX
- Phase Shifter
- Attenuator

Electrical Specifications at 25°C

Parameter	Frequency (MHz)	Min.	Typ.	Max.	Unit
Frequency		1700		3100	MHz
Insertion Loss (Avg. Of Coupled Outputs) above 3 dB	1700-1850		0.4	0.6	dB
	1850-1990		0.4	0.6	
	1990-2170		0.5	0.7	
	2170-2400		0.5	0.7	
	2400-2700		0.5	0.7	
Isolation	1700-1850	17	23		dB
	1850-1990	18	24		
	1990-2170	18	25		
	2170-2400	18	25		
	2400-2700	18	25		
Phase Unbalance	1700-1850		2.0	7.0	Degree
	1850-1990		2.0	7.0	
	1990-2170		2.0	7.0	
	2170-2400		2.0	7.0	
	2400-2700		2.0	7.0	
Amplitude Unbalance	1700-1850		0.6	1.2	dB
	1850-1990		0.2	0.7	
	1990-2170		0.5	1.0	
	2170-2400		0.5	1.0	
	2400-2700		0.5	1.0	
VSWR	1700-3100		1.2		:1

Electrical Schematic

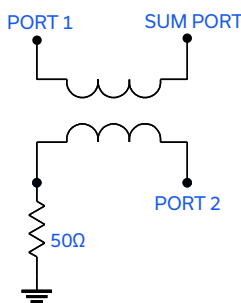

Demo Board MCL P/N: TB-489-312+ Suggested PCB Layout (PL-304)

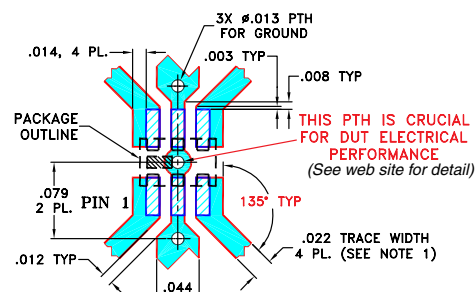

NOTES:

1. TRACE WIDTH IS SHOWN FOR ROGERS RO4350B WITH DIELECTRIC THICKNESS .010" ± .001"; COPPER: 1/2 OZ. EACH SIDE. FOR OTHER MATERIALS TRACE WIDTH MAY NEED TO BE MODIFIED.
2. BOTTOM SIDE OF THE PCB IS CONTINUOUS GROUND PLANE.

- DENOTES PCB COPPER LAYOUT WITH SMOBC (SOLDER MASK OVER BARE COPPER)
- DENOTES COPPER LAND PATTERN FREE OF SOLDER MASK

Notes

- A. Performance and quality attributes and conditions not expressly stated in this specification document are intended to be excluded and do not form a part of this specification document.
 B. Electrical specifications and performance data contained in this specification document are based on Mini-Circuits' applicable established test performance criteria and measurement instructions.
 C. The parts covered by this specification document are subject to Mini-Circuits' standard limited warranty and terms and conditions (collectively, "Standard Terms"); Purchasers of this part are entitled to the rights and benefits contained therein. For a full statement of the Standard Terms and the exclusive rights and remedies thereunder, please visit Mini-Circuits' website at www.minicircuits.com/MCLStore/terms.jsp



Typical Performance Data

Frequency (MHz)	Total Loss ¹ (dB)		Amplitude Unbalance (dB)	Isolation (dB)	Phase Unbalance (deg.)	VSWR S	VSWR 1	VSWR 2
	S-1	S-2						
1700.00	3.68	3.00	0.69	24.22	87.12	1.01	1.30	1.02
1740.00	3.62	3.05	0.57	24.46	87.14	1.01	1.29	1.01
1820.00	3.50	3.16	0.34	25.20	87.18	1.02	1.28	1.02
1850.00	3.46	3.20	0.27	25.42	87.19	1.03	1.27	1.02
1900.00	3.41	3.26	0.14	25.94	87.20	1.03	1.26	1.03
1975.00	3.33	3.34	0.02	26.65	87.18	1.04	1.25	1.05
1990.00	3.32	3.36	0.05	26.85	87.19	1.04	1.24	1.05
2000.00	3.31	3.37	0.07	26.96	87.18	1.05	1.24	1.05
2100.00	3.23	3.47	0.24	28.10	87.09	1.06	1.22	1.07
2200.00	3.17	3.55	0.37	29.40	86.98	1.07	1.20	1.09
2300.00	3.14	3.61	0.47	30.83	86.82	1.08	1.17	1.11
2400.00	3.13	3.65	0.52	32.53	86.67	1.09	1.15	1.13
2500.00	3.14	3.67	0.52	34.34	86.51	1.10	1.13	1.14
3000.00	3.61	3.33	0.28	43.36	86.44	1.09	1.04	1.11
3100.00	3.82	3.17	0.65	43.80	86.58	1.07	1.04	1.08

1. Total Loss = Insertion Loss + 3dB splitter loss.

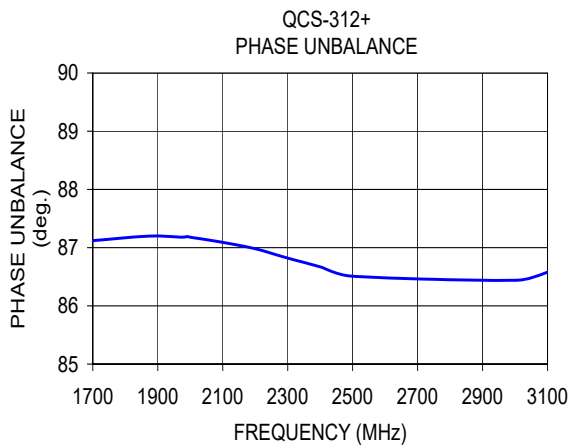
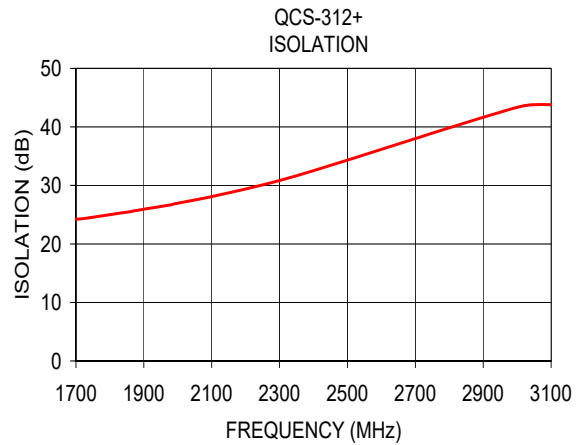
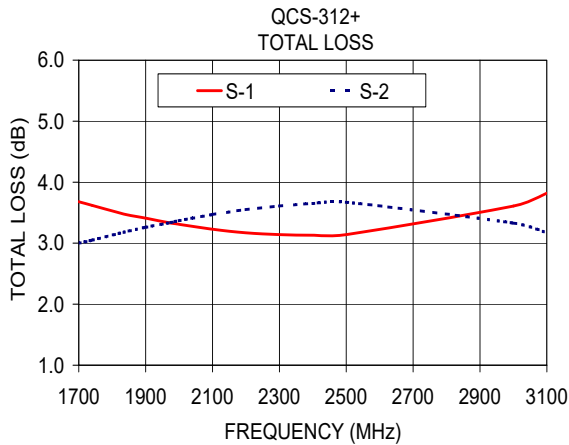

Notes

- A. Performance and quality attributes and conditions not expressly stated in this specification document are intended to be excluded and do not form a part of this specification document.
- B. Electrical specifications and performance data contained in this specification document are based on Mini-Circuits' applicable established test performance criteria and measurement instructions.
- C. The parts covered by this specification document are subject to Mini-Circuits standard limited warranty and terms and conditions (collectively, "Standard Terms"); Purchasers of this part are entitled to the rights and benefits contained therein. For a full statement of the Standard Terms and the exclusive rights and remedies thereunder, please visit Mini-Circuits' website at www.minicircuits.com/MCLStore/terms.jsp



2 Way-90° Power Splitter/Combiner

QCS-312+

Typical Performance Data

FREQ. (MHz)	TOTAL LOSS ¹		AMP. UNBAL. (dB)	ISOLATION (dB)	PHASE UNBAL. (Deg.)	FREQ. (MHz)	VSWR		
	(dB)						(:1)		
	S-1	S-2					S	1	2
1700.0	3.68	3.00	0.69	24.22	87.12	1700.0	1.01	1.30	1.02
1720.0	3.65	3.02	0.63	24.34	87.13	1720.0	1.01	1.30	1.01
1740.0	3.62	3.05	0.57	24.46	87.14	1740.0	1.01	1.29	1.01
1760.0	3.59	3.08	0.51	24.61	87.15	1760.0	1.01	1.29	1.01
1780.0	3.56	3.11	0.45	24.82	87.17	1780.0	1.02	1.28	1.01
1800.0	3.53	3.13	0.40	25.02	87.18	1800.0	1.02	1.28	1.01
1820.0	3.50	3.16	0.34	25.20	87.18	1820.0	1.02	1.28	1.02
1840.0	3.48	3.19	0.29	25.34	87.20	1840.0	1.02	1.27	1.02
1850.0	3.46	3.20	0.27	25.42	87.19	1850.0	1.03	1.27	1.02
1900.0	3.41	3.26	0.14	25.94	87.20	1900.0	1.03	1.26	1.03
1950.0	3.35	3.32	0.03	26.40	87.18	1950.0	1.04	1.25	1.04
1975.0	3.33	3.34	0.02	26.65	87.18	1975.0	1.04	1.25	1.05
1990.0	3.32	3.36	0.05	26.85	87.19	1990.0	1.04	1.24	1.05
2000.0	3.31	3.37	0.07	26.96	87.18	2000.0	1.05	1.24	1.05
2050.0	3.26	3.42	0.16	27.58	87.14	2050.0	1.05	1.23	1.06
2100.0	3.23	3.47	0.24	28.10	87.09	2100.0	1.06	1.22	1.07
2150.0	3.20	3.51	0.31	28.78	87.03	2150.0	1.07	1.21	1.08
2200.0	3.17	3.55	0.37	29.40	86.98	2200.0	1.07	1.20	1.09
2250.0	3.16	3.58	0.43	30.21	86.92	2250.0	1.08	1.19	1.10
2300.0	3.14	3.61	0.47	30.83	86.82	2300.0	1.08	1.17	1.11
2400.0	3.13	3.65	0.52	32.53	86.67	2400.0	1.09	1.15	1.13
2450.0	3.14	3.66	0.53	33.25	86.61	2450.0	1.10	1.14	1.13
2500.0	3.14	3.67	0.52	34.34	86.51	2500.0	1.10	1.13	1.14
2550.0	3.16	3.67	0.51	35.05	86.48	2550.0	1.11	1.11	1.14
2600.0	3.18	3.66	0.48	36.05	86.39	2600.0	1.11	1.10	1.14
2800.0	3.33	3.56	0.23	39.38	86.29	2800.0	1.11	1.06	1.14
3000.0	3.61	3.33	0.28	43.36	86.44	3000.0	1.09	1.04	1.11
3100.0	3.82	3.17	0.65	43.80	86.58	3100.0	1.07	1.04	1.08

¹Total Loss = Insertion Loss + 3dB Splitter Loss



Typical Performance Curves

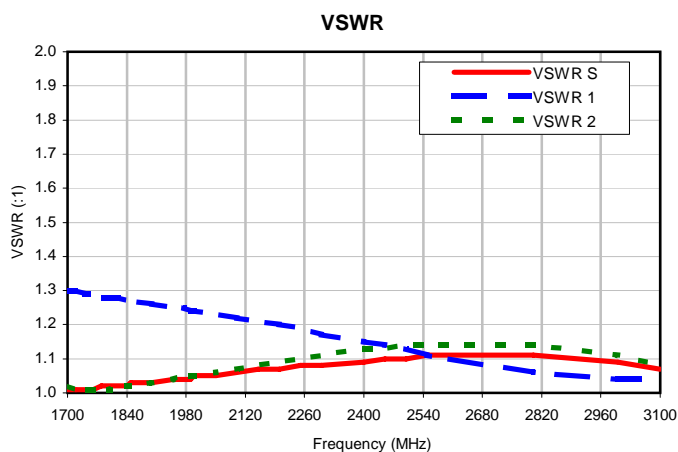
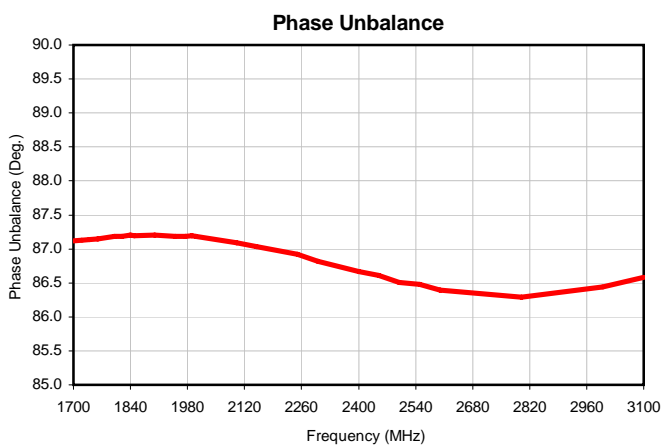
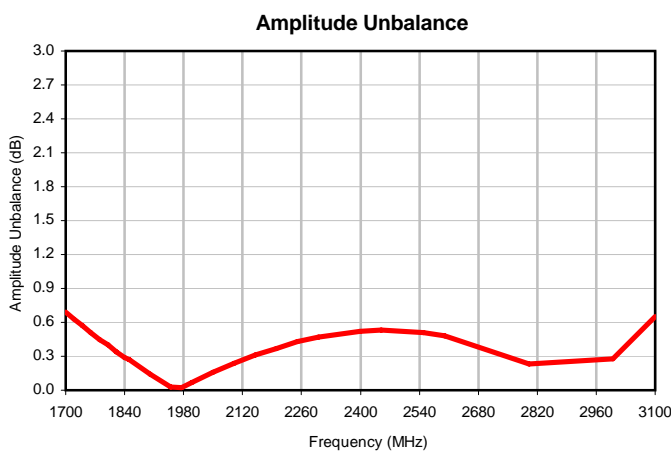
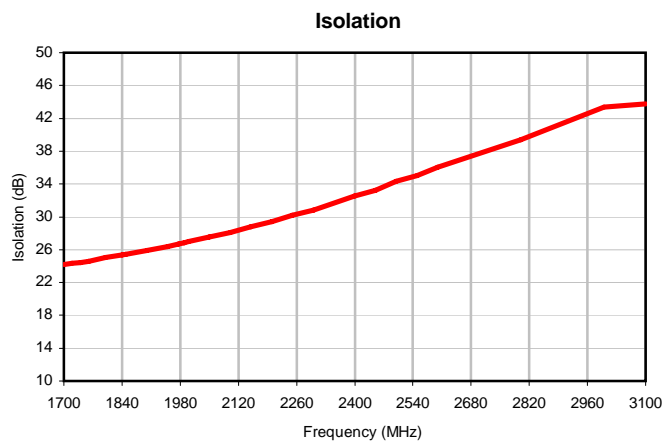
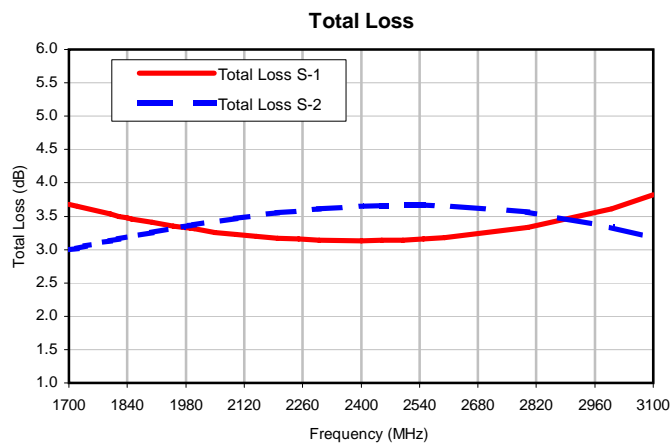

Outline Dimensions

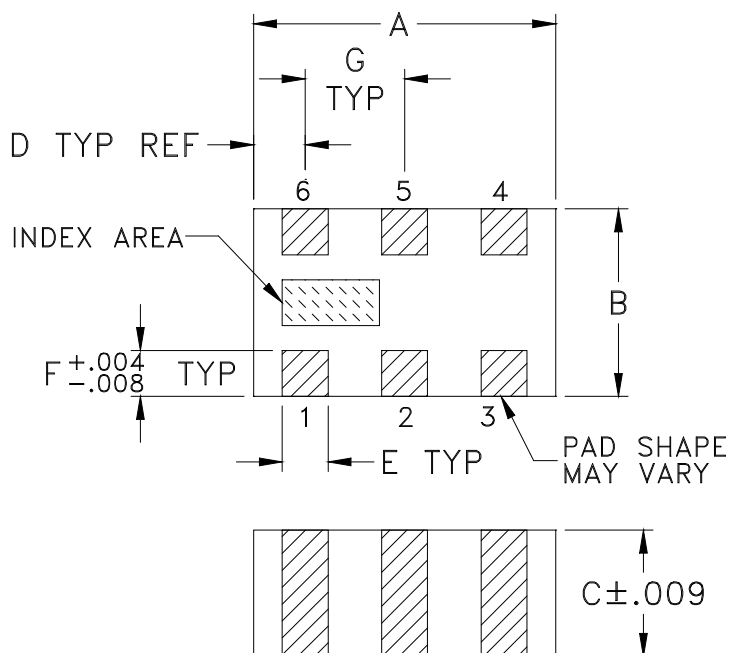

PCB Land Pattern

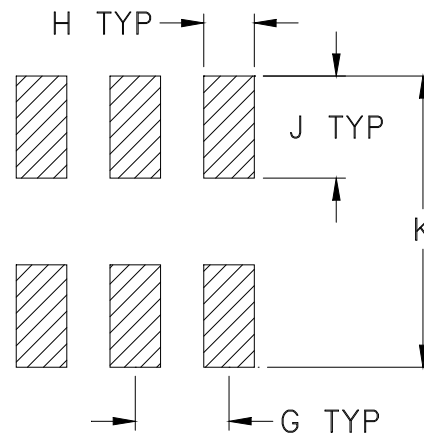

Suggested Layout,
Tolerance to be within ± 0.002

CASE #	A	B	C	D	E	F	G	H	J	K	WT. GRAM
GE0805C-1	.079 (2.00)	.049 (1.25)	.033 (0.84)	.014 (0.35)	.012 (0.30)	.012 (0.30)	.026 (0.65)	.014 (0.35)	.039 (1.00)	.110 (2.80)	.008

Dimensions are in inches (mm). Tolerances: 2Pl. $\pm .01$; 3 Pl. $\pm .005$

Notes:

- Open style, ceramic base.
- Termination finish: For RoHS Case Styles: Tin plate over Nickel plate. All models, (+) suffix.
For RoHS-5 Case Style: Tin-lead plate. All models, no (+) suffix.



P.O. Box 350166, Brooklyn, New York 11235-0003 (718) 934-4500 Fax (718) 332-4661 For detailed performance specs & shopping online see Mini-Circuits web site



The Design Engineers Search Engine Provides ACTUAL Data Instantly From MINI-CIRCUITS At: www.minicircuits.com

RF/IF MICROWAVE COMPONENTS

Tape & Reel Packaging TR-F74

DEVICE ORIENTATION IN T&R

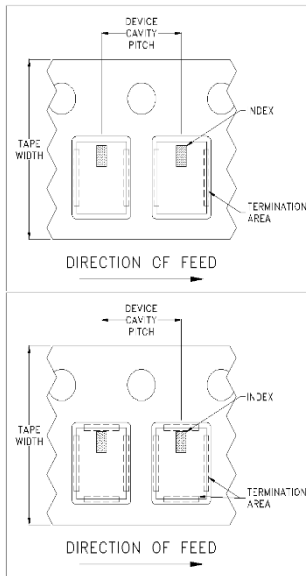

ILLUSTRATION 1

Applicable Case Styles

GE0805C-1
 GE0805C-1AP
 JV1210C-1
 GU2939

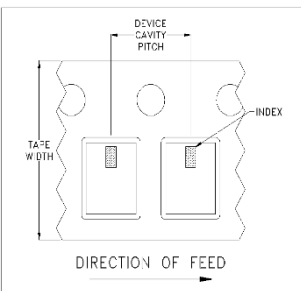

ILLUSTRATION 2

Applicable Case Styles

JV1210C
 JV1210C-2
 JV1210C-3
 JV1210C-4
 JV1210C-5
 JV1210C-6
 JV1210C-11

ILLUSTRATION 3

Applicable Case Styles

JC0603C-8
 JC0603C-9
 JV1210C-7
 JV1210C-8
 JV1210C-9
 JV1210C-10
 JV1210C-13
 GE0805C-13
 GE0805C-19
 GE0805C-20

Tape Width, mm	Device Cavity Pitch, mm	Real Size, inches	Devices per Reel	
8	4	7	Small quantity standards (see note)	20
				50
				100
				200
				500
				1000
			Standard	2000
				4000

Note: Small reel availability varies by model. Refer to pricing and availability on individual model dashboard.

Mini-Circuits carrier tape materials provide protection from ESD (Electro-Static Discharge) during handling and transportation. Tapes are static dissipative and comply with industry standards EIA-481/EIA-541.

Go to: www.minicircuits.com/pages/pdfs/tape.pdf



Distribution Centers NORTH AMERICA 800-654-7949 • 417-335-5935 • Fax 417-335-5945 • EUROPE 44-1252-832600 • Fax 44-1252-837010

Mini-Circuits ISO 9001 & ISO 14001 Certified

INTERNET <http://www.minicircuits.com>

P.O. Box 350166, Brooklyn, New York 11235-0003 (718) 934-4500 Fax (718) 332-4661

THIRD ANGLE PROJECTION

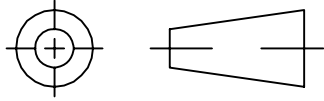

REVISIONS

REV	ECN No.	DESCRIPTION	DATE	DR	AUTH
OR	M122595	NEW RELEASE	04/27/09	MMG	ABD

SUGGESTED MOUNTING CONFIGURATION FOR
GE0805C-1 CASE STYLE, "06SQ07" PIN CODE

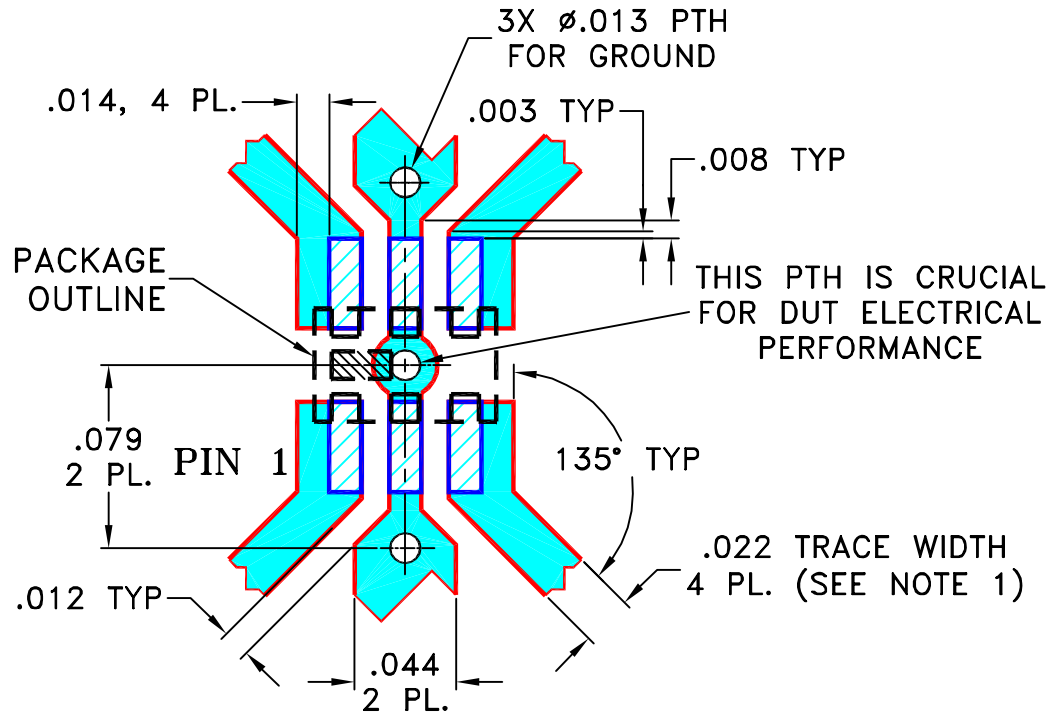

- NOTES: 1. TRACE WIDTH IS SHOWN FOR ROGERS RO4350B WITH DIELECTRIC THICKNESS .010" ± .001"; COPPER: 1/2 OZ. EACH SIDE. FOR OTHER MATERIALS TRACE WIDTH MAY NEED TO BE MODIFIED.
2. BOTTOM SIDE OF THE PCB IS CONTINUOUS GROUND PLANE.



DENOTES PCB COPPER LAYOUT WITH SMOBC (SOLDER MASK OVER BARE COPPER)



DENOTES COPPER LAND PATTERN FREE OF SOLDER MASK

UNLESS OTHERWISE SPECIFIED

INITIALS

DATE

DIMENSIONS ARE IN INCHES

TOLERANCES ON:

2 PL DECIMALS ±

3 PL DECIMALS ± .005

ANGLES ± 1°

FRACTIONS ±

DRAWN

MMG

04/27/09

CHECKED

AV

04/27/09

APPROVED

ABD

04/27/09



Mini-Circuits®

13 Neptune Avenue
Brooklyn NY 11235

PL, 06SQ07, GE0805C-1, TB-489+

THIS DOCUMENT AND ITS CONTENTS ARE THE PROPERTY OF MINI-CIRCUITS. EXCEPT FOR USE EXPRESSLY GRANTED, IN WRITING, TO ITS VENDORS, VENDEE AND THE UNITED STATES GOVERNMENT, MINI-CIRCUITS RESERVES ALL PROPRIETARY DESIGN, USE, MANUFACTURING AND REPRODUCTION RIGHTS THERETO. THESE CONTENTS SHALL NOT BE USED, DUPLICATED OR DISCLOSED TO ANY OUTSIDE PARTY, IN WHOLE OR IN PART, WITHOUT WRITTEN PERMISSION OF MINI-CIRCUITS.

Mini-Circuits®

SIZE
A

CODE IDENT
15542

DRAWING NO:
98-PL-304

REV:
OR

FILE: 98PL304

SCALE: 12:1

SHEET: 1 OF 1

ASHEETA1.DWG REV:A DATE:01/12/95

Evaluation Board and Circuit

For Pin Connections refer to Data Sheet of the DUT

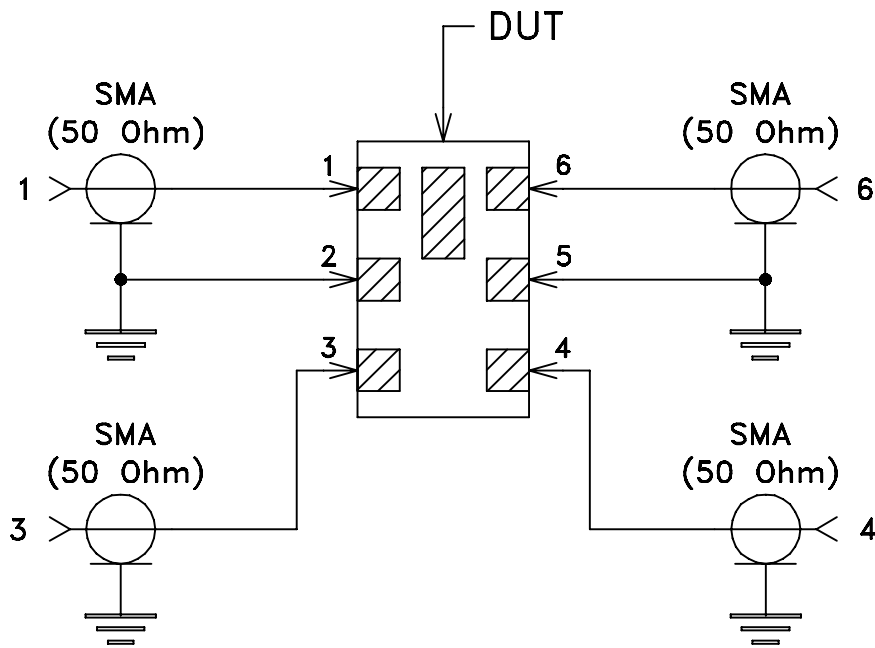
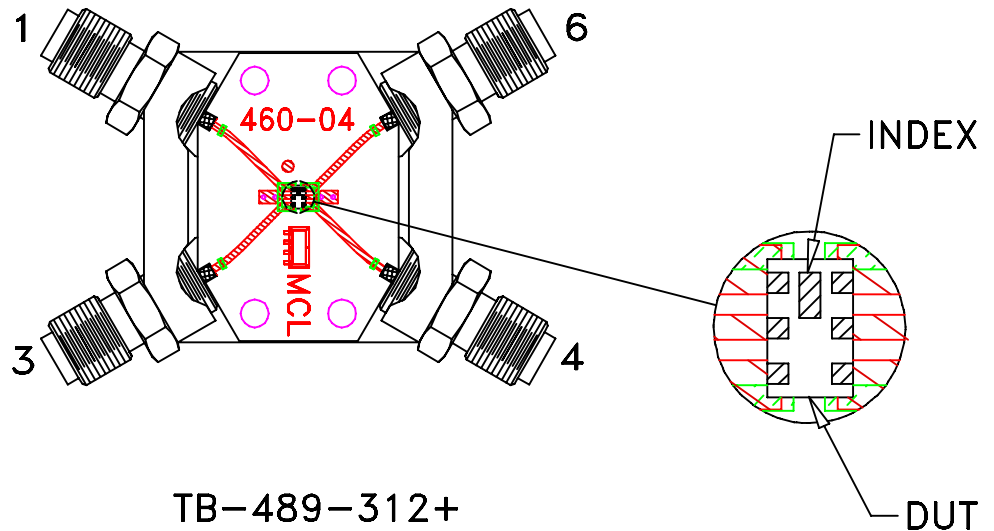

Schematic Diagram

Notes:

1. 50 Ohm SMA Female connectors.
2. PCB Material: Rogers R04350 or equivalent, Dielectric Constant=3.5, Thickness=.010 inch.

 Mini-Circuits®

All Mini-Circuits products are manufactured under exacting quality assurance and control standards, and are capable of meeting published specifications after being subjected to any or all of the following physical and environmental test.

Specification	Test/Inspection Condition	Reference/Spec
Operating Temperature	-55° to 100°C Ambient Environment	Individual Model Data Sheet
Storage Temperature	-55° to 100° C Ambient Environment	Individual Model Data Sheet
Humidity	90 to 95% RH, 240 hours, 50°C	MIL-STD-202, Method 103, Condition A, Except 50°C and end-point electrical test done within 12 hours
Solder Reflow Heat	Sn-Pb Eutetic Process: 225°C peak Pb-Free Process 245° - 250°C peak	J-STD-020, Table 4-1, 4-2 and 5-2, Figure 5-1
Solderability	10X Magnification	J-STD-002, Para 4.2.5, Test S, 95% Coverage
Vibration (High Frequency)	20g peak, 10-2000 Hz, 12 times in each of three perpendicular directions (total 36)	MIL-STD-202, Method 204, Condition D
Mechanical Shock	50g, 11 ms, 1/2-sine, 18 shocks: 3 each direction, each of 3 axes	MIL-STD-202, Method 213, Condition A