



USB & ETHERNET CONTROLLED

# RF SP4T Switch Matrix RC-1SP4T-40

50Ω DC to 40 GHz 2.92mm-Female

## THE BIG DEAL

- Mechanical SP4T switch
- Excellent performance to 40 GHz
- High reliability, 2 million switch cycles
- 5W power rating (cold switching)

## APPLICATIONS

- 5G node / device testing
- Automated test equipment
- Fail-safe / redundancy switching



CASE STYLE: MR2935

[DOWNLOAD](#)

SOFTWARE PACKAGE

**RoHS Compliant**

See our website for RoHS Compliance methodologies and qualifications

## PRODUCT OVERVIEW

Mini-Circuits' RC-1SP4T-40 is an electro-mechanical SP4T switch operating over an extremely wide bandwidth, from DC to 40 GHz with high isolation and low insertion loss. The absorptive switch is of a failsafe and break-before-make-configuration, with a lifetime of 2 million switching cycles, when used within the noted specifications.

The switch box is constructed in a compact, rugged metal case (5.5 x 6.0 x 2.75") with all 2.92 mm (f) RF connectors on the front panel. The switches are controlled via USB or Ethernet, allowing control directly from a PC, or remotely over a network. Full software support is provided, including our user-friendly GUI application for Windows and a full API with programming instructions for Windows and Linux environments (both 32-bit and 64-bit systems).

## KEY FEATURES

Feature	Advantages
Mechanical SP4T switch	Mechanical absorptive switches provide high reliability, repeatable high performance and internal terminations of input signals on the disconnected paths
Operation from DC to 40 GHz	Supports a wide range of RF test and signal routing applications, including 2G, 3G, 4G and 5G, with a single device.
Break-before-make configuration	Prevents a momentary connection of the old and new signal paths, reducing the inconsistent transient effects that could otherwise be observed during switching
USB & Ethernet control	USB HID and Ethernet (HTTP / Telnet) interfaces provide easy compatibility with a wide range of software setups and programming environments
Full software support	User friendly Windows GUI (graphical user interface) allows manual control straight out of the box, while the comprehensive API (application programming interface) with examples and instructions allows easy automation in most programming environments





USB & ETHERNET CONTROLLED

# RF SP4T Switch Matrix RC-1SP4T-40

Mini-Circuits

50Ω DC to 40 GHz 2.92mm-Female

## ELECTRICAL SPECIFICATIONS AT +25°C

Parameter	Conditions	Min.	Typ.	Max.	Units
Frequency		DC		40	GHz
Path Loss	DC - 12 GHz		0.2	0.5	dB
	12 - 26 GHz		0.3	0.7	
	26 - 40 GHz		0.6	1.1	
Isolation <sup>1</sup> (Inactive Paths)	DC - 12 GHz	60	80		dB
	12 - 26 GHz	55	75		
	26 - 40 GHz	50	65		
Return Loss <sup>2</sup>	DC - 12 GHz		19		dB
	12 - 26 GHz		17		
	26 - 40 GHz		14		
Switching Time			25		ms
RF Input Power	Cold switching, DC - 12 GHz			20	W
	Cold switching, 12 - 26 GHz			10	
	Cold switching, 26 - 40 GHz			5	
	Hot switching <sup>3</sup>			0.1	
	Into internal termination <sup>4</sup>			1	
Switch Lifetime			2		million cycles

1. Isolation measured between Com and any disconnected port. Example: Isolation for Com to 1 is the leakage measured at port 1 from a signal input at Com when the active switch path is set to Com to 2

2. Return loss into Com when active or ports 1-4 in any state; Com is reflective when disconnected

3. Hot switching power above this level will degrade the switch lifetime

4. Maximum power into any internal termination is 1W per port, 3W total per switch

## ABSOLUTE MAXIMUM RATINGS

Parameters	Ratings
Operating Temperature	0°C to 40°C
Storage Temperature	-15°C to 85°C
Supply Voltage	26V





USB & ETHERNET CONTROLLED

# RF SP4T Switch Matrix RC-1SP4T-40

50Ω DC to 40 GHz 2.92mm-Female

### SWITCHING CONFIGURATION:

- Normally open (all port disconnected)
- Absorptive (internal terminations on ports J1-J4)

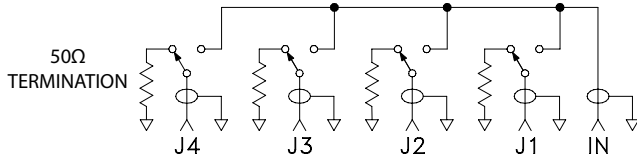

### CONNECTIONS

Port Name	Connector Type
RF Switch A (Com,1,2,3&4)	2.92 mm female
USB	USB type-B
Ethernet / LAN	RJ45
24V <sub>DC</sub> Input	2.1mm center positive DC socket

### OUTLINE DRAWING (MR2935)

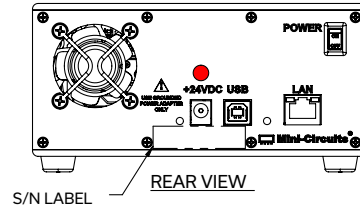
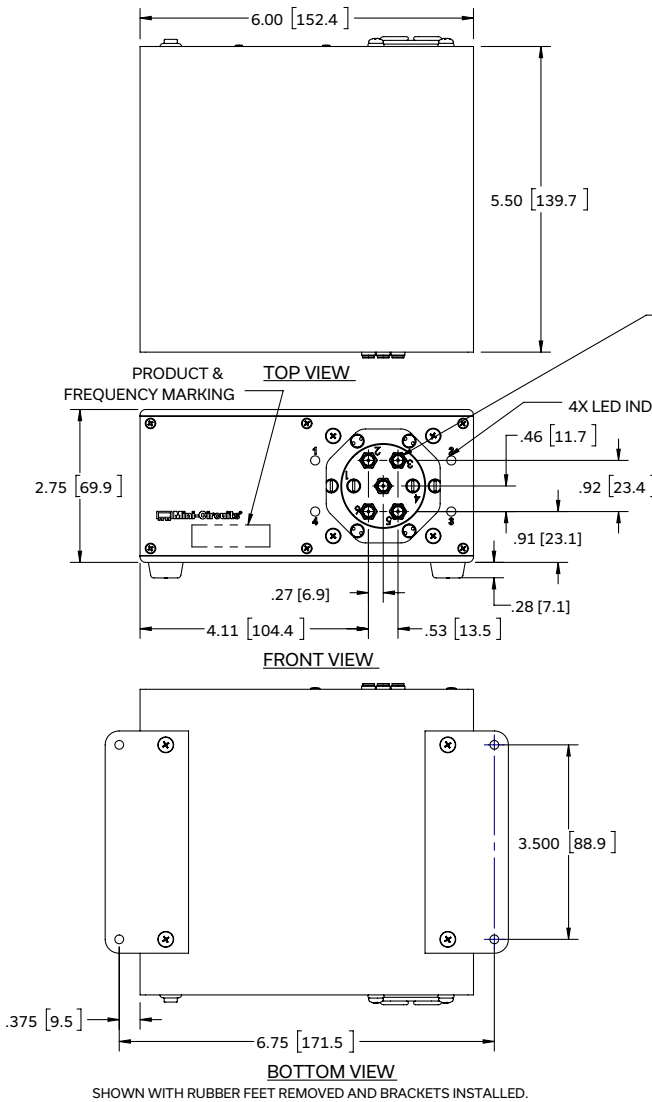

### BRACKET OPTION ONE SET OF 2 EACH

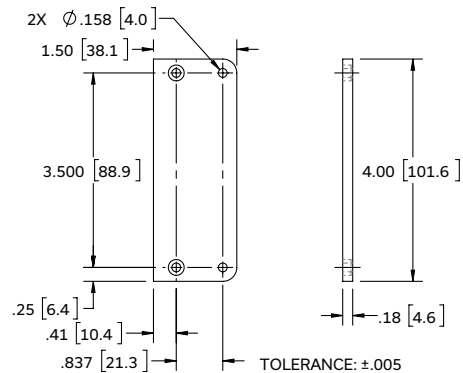

INSTRUCTIONS FOR MOUNTING BRACKETS:  
 TOOL REQUIRED: PHILLIPS HEAD SCREWDRIVER  
 STEP 1: REMOVE RUBBER FEET FROM THE BOTTOM OF THE UNIT, DO NOT DISCARD THE FASTENERS.  
 STEP 2: MOUNT THE BRACKETS WITH THE FASTENERS REMOVED IN STEP 1, USING THE COUNTER BORE HOLES IN THE BRACKET.

Weight: 1060 grams.

Dimensions are in inches [mm]. Tolerances: 2 Pl.±.03 inch; 3 Pl.±.015 inch





USB & ETHERNET CONTROLLED

# RF SP4T Switch Matrix RC-1SP4T-40

Mini-Circuits

50Ω DC to 40 GHz 2.92mm-Female

## TYPICAL PERFORMANCE GRAPHS (PER SWITCH)

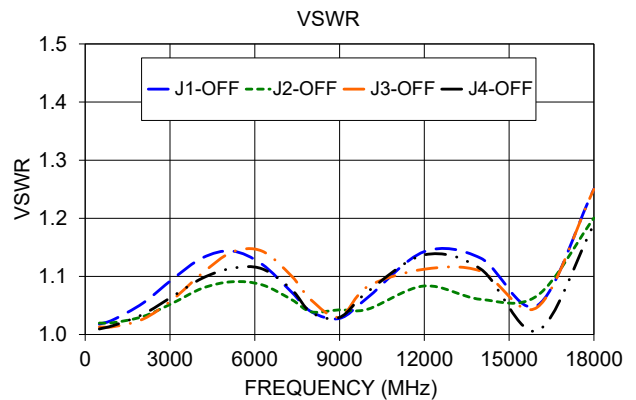
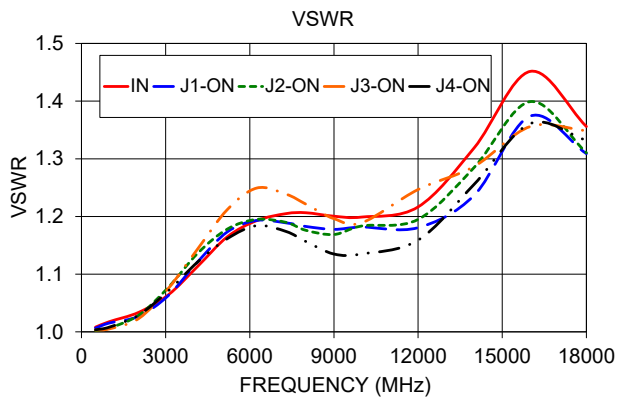
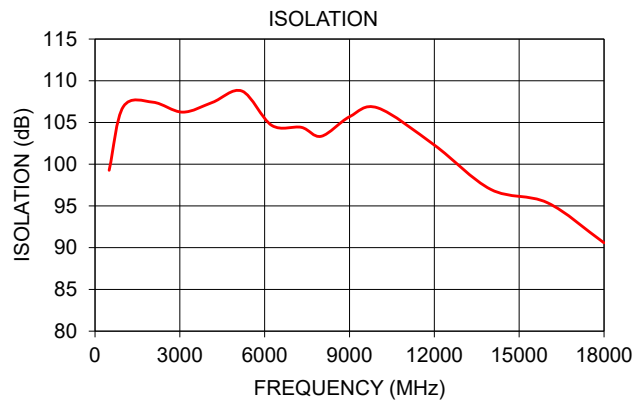
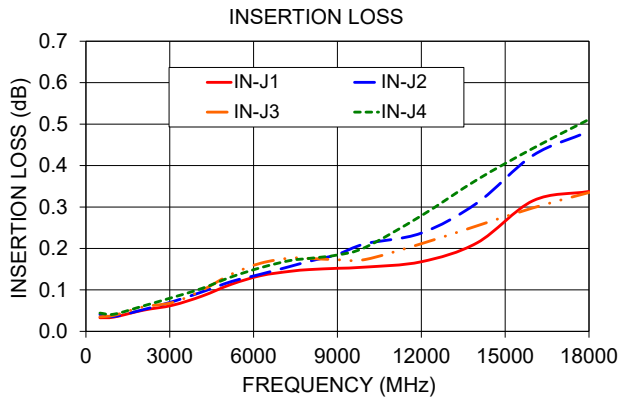



USB & ETHERNET CONTROLLED

# RF SP4T Switch Matrix **RC-1SP4T-40**

50Ω DC to 40 GHz 2.92mm-Female

## SOFTWARE SPECIFICATIONS

### SOFTWARE & DOCUMENTATION DOWNLOAD:

- Mini-Circuits' full software and support package including user guide, Windows GUI, DLL files, programming manual and examples can be downloaded free of charge from: <https://www.minicircuits.com/softwaredownload/rfswitchcontroller.html>
- Please contact [testsolutions@minicircuits.com](mailto:testsolutions@minicircuits.com) for support

### MINIMUM SYSTEM REQUIREMENTS:

Parameter	Requirements	
Interface	USB HID & Ethernet (HTTP & Telnet)	
System Requirements	GUI	Windows 98 or later
	USB API DLL	Windows 98 or later and programming environment with ActiveX or .NET support
	USB Direct Programming	Linux, Windows 98 or later
	Ethernet	Windows, Linux or Mac computer with a network port and Ethernet TCP/IP support
Hardware	Pentium II or later with 256 MB RAM	

### APPLICATION PROGRAMMING INTERFACE (API)

#### ETHERNET SUPPORT:

- Simple ASCII / SCPI command set for attenuator control
- Communication via HTTP or Telnet
- Supported by most common programming environments

#### USB SUPPORT (WINDOWS):

- ActiveX COM DLL file for creation of 32-bit programs
- .NET library DLL file for creation of 32 / 64-bit programs
- Supported by most common programming environments (refer to application note AN-49-001 for summary of supported environments)

#### USB SUPPORT (LINUX):

- Direct USB programming using a series of USB interrupt codes

Full programming instructions and examples available for a wide range of programming environments / languages.



USB & ETHERNET CONTROLLED

# RF SP4T Switch Matrix RC-1SP4T-40

50Ω DC to 40 GHz 2.92mm-Female

## GRAPHICAL USER INTERFACE (GUI) FOR WINDOWS - KEY FEATURES

- Connect via USB or Ethernet
- Run GUI in "demo mode" to evaluate software without a hardware connection

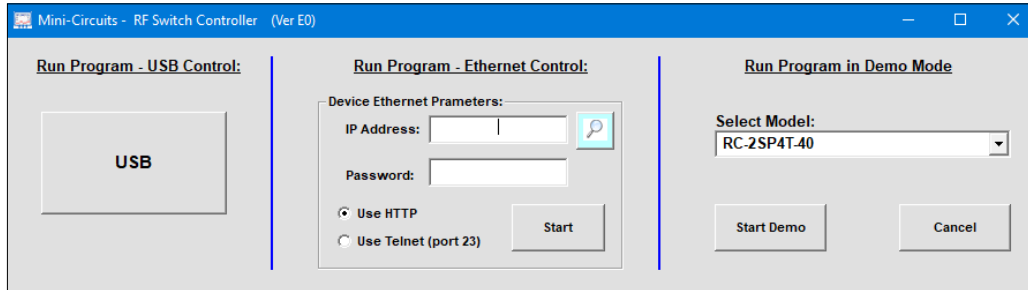

- View and set switch states at the click of a button
- Configure and run timed switching sequences
- Set start-up switch state
- Configure Ethernet IP settings

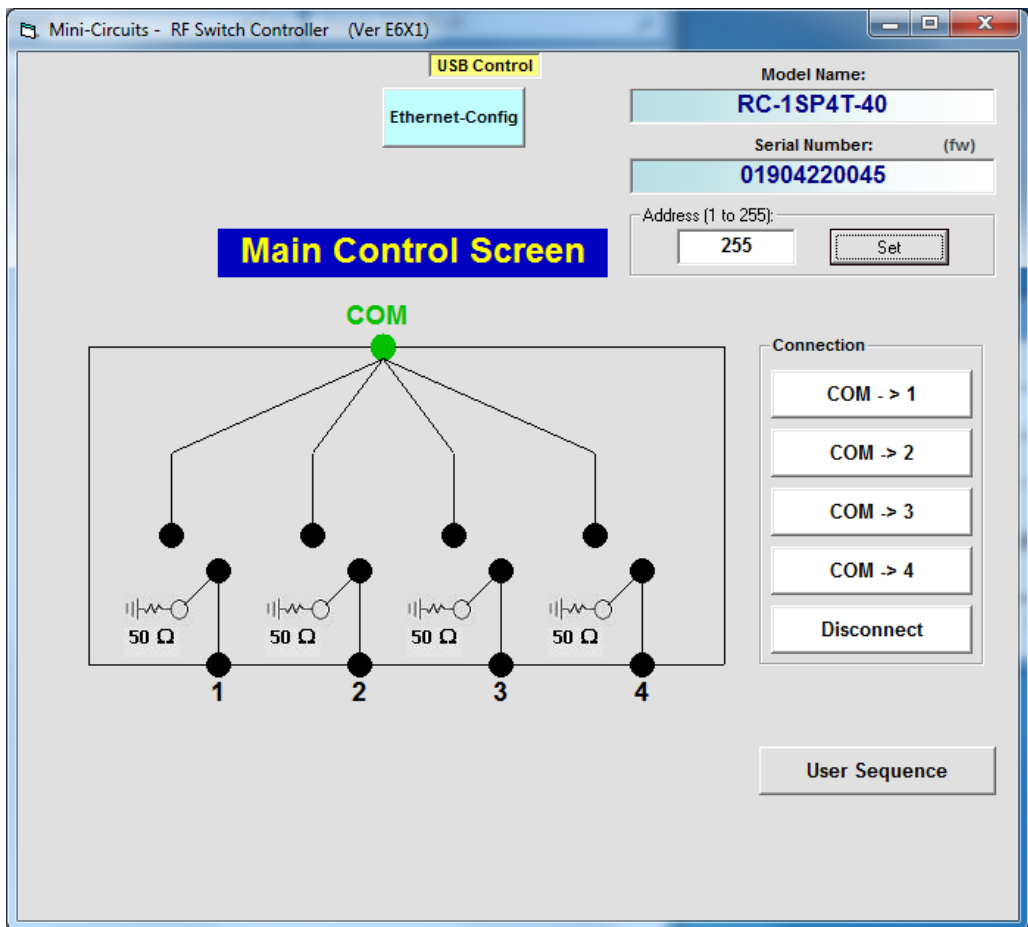



USB & ETHERNET CONTROLLED



# RF SPDT Switch Matrix RC-1SPDT-40





50Ω DC to 40 GHz 2.92mm-Female

## ORDERING INFORMATION

Please contact Mini-Circuits' Test Solutions department for price and availability: [testsolutions@minicircuits.com](mailto:testsolutions@minicircuits.com)

Model	Description
RC-1SP4T-40	USB & Ethernet controlled SP4T switch matrix

Included Accessories	Part No.	Description
	AC/DC-24-3W1	AC/DC 24V <sub>DC</sub> Grounded Power Adaptor. Operating temperature: 0°C to +40°C, I <sub>Max</sub> =2.5A
See Below	CBL-3W1-XX	AC Power Cord (Select one power cord from below with each Switch Matrix box)
	USB-CBL-AB-3+	2.7 ft (0.8 m) USB Cable: USB type A(Male) to USB type B(Male)

AC Power Cords <sup>3</sup>	Part No.	Description
	CBL-3W1-US	Power Cord for United States
	CBL-3W1-EU	Power Cord for Europe
	CBL-3W1-UK	Power Cord for United Kingdom
	CBL-3W1-AU	Power Cord for Australia and China
	CBL-3W1-IL	Power Cord for Israel

3. If you need a Power cord for a country not listed please contact [testsolutions@minicircuits.com](mailto:testsolutions@minicircuits.com)

## OPTIONAL ACCESSORIES

USB-CBL-AB-3+	2.7 ft (0.8 m) USB Cable: USB type A(Male) to USB type B(Male)
USB-CBL-AB-7+	6.8 ft (2.1 m) USB Cable: USB type A(Male) to USB type B(Male)
USB-CBL-AB-11+	11 ft (3.4 m) USB Cable: USB type A(Male) to USB type B(Male)
CBL-RJ45-MM-5+	5 ft (1.5 m) Ethernet cable: RJ45(Male) to RJ45(Male) Cat 5E cable
BKT-272-08+	Bracket (One set of 2 each)

- NOTES**
- A. Performance and quality attributes and conditions not expressly stated in this specification document are intended to be excluded and do not form a part of this specification document.
  - B. Electrical specifications and performance data contained in this specification document are based on Mini-Circuit's applicable established test performance criteria and measurement instructions.
  - C. The parts covered by this specification document are subject to Mini-Circuits standard limited warranty and terms and conditions (collectively, "Standard Terms"); Purchasers of this part are entitled to the rights and benefits contained therein. For a full statement of the standard. Terms and the exclusive rights and remedies thereunder, please visit Mini-Circuits' website at [www.minicircuits.com/MCLStore/terms.jsp](http://www.minicircuits.com/MCLStore/terms.jsp)



Typical Performance Data

FREQUENCY (MHz)	INSERTION LOSS (dB)				ISOLATION (dB)				VSWR (Active Ports) (:1)					VSWR (Inactive Ports) (:1)			
	IN-J1	IN-J2	IN-J3	IN-J4	IN-J1	IN-J2	IN-J3	IN-J4	IN	J1	J2	J3	J4	J1	J2	J3	J4
10	0.03	0.03	0.03	0.03	71.03	67.46	82.60	72.57	1.01	1.00	1.00	1.01	1.00	1.00	1.00	1.02	1.02
50	0.01	0.01	0.01	0.01	85.37	78.17	80.69	92.02	1.00	1.00	1.00	1.00	1.00	1.00	1.00	1.02	1.01
100	0.01	0.01	0.01	0.01	94.69	83.43	92.51	86.60	1.01	1.00	1.00	1.00	1.00	1.00	1.01	1.02	1.01
200	0.02	0.02	0.01	0.02	93.59	107.52	90.47	81.91	1.01	1.01	1.01	1.01	1.01	1.01	1.01	1.02	1.01
400	0.03	0.03	0.03	0.03	83.85	85.56	83.45	85.45	1.01	1.01	1.01	1.01	1.01	1.01	1.01	1.03	1.02
600	0.04	0.04	0.03	0.03	86.98	90.22	83.71	91.87	1.01	1.01	1.01	1.01	1.01	1.02	1.02	1.03	1.02
800	0.04	0.04	0.04	0.04	88.40	95.17	92.91	91.61	1.02	1.01	1.01	1.01	1.01	1.02	1.02	1.03	1.02
1000	0.05	0.05	0.05	0.04	93.82	96.54	98.86	96.21	1.02	1.01	1.01	1.01	1.01	1.02	1.02	1.03	1.03
1200	0.05	0.05	0.05	0.05	86.54	87.41	88.26	86.35	1.02	1.00	1.00	1.01	1.00	1.02	1.03	1.03	1.03
1400	0.06	0.06	0.06	0.05	95.01	100.79	94.44	95.99	1.03	1.00	1.00	1.00	1.00	1.03	1.03	1.03	1.03
1600	0.06	0.06	0.06	0.06	91.61	91.73	87.27	94.49	1.03	1.01	1.01	1.00	1.01	1.03	1.03	1.03	1.04
1800	0.06	0.06	0.06	0.06	91.94	94.40	93.82	90.90	1.04	1.02	1.01	1.01	1.01	1.03	1.03	1.03	1.04
2000	0.07	0.07	0.06	0.06	84.83	88.13	87.73	97.25	1.04	1.02	1.02	1.01	1.02	1.03	1.03	1.03	1.04
2200	0.07	0.07	0.07	0.07	94.32	100.32	89.28	91.58	1.05	1.03	1.03	1.02	1.03	1.02	1.03	1.02	1.04
2600	0.08	0.08	0.08	0.07	95.22	106.18	87.77	95.63	1.07	1.05	1.05	1.04	1.05	1.02	1.03	1.02	1.04
2800	0.09	0.09	0.08	0.08	97.95	97.71	94.36	106.43	1.08	1.06	1.06	1.05	1.06	1.02	1.02	1.01	1.04
3000	0.09	0.09	0.09	0.08	91.06	89.49	91.18	90.09	1.08	1.08	1.07	1.06	1.07	1.02	1.02	1.01	1.04
3200	0.10	0.10	0.09	0.09	97.19	91.73	92.10	94.96	1.09	1.09	1.08	1.07	1.08	1.01	1.02	1.00	1.03
3400	0.10	0.10	0.10	0.10	90.93	88.16	98.53	86.49	1.11	1.10	1.09	1.08	1.09	1.01	1.02	1.00	1.03
3600	0.10	0.10	0.10	0.10	93.22	90.58	89.80	89.07	1.12	1.11	1.10	1.09	1.10	1.01	1.02	1.01	1.03
3800	0.11	0.11	0.10	0.10	88.73	87.49	88.59	96.63	1.12	1.12	1.11	1.10	1.11	1.01	1.02	1.01	1.03
4000	0.11	0.11	0.10	0.10	86.29	98.01	99.98	95.27	1.13	1.13	1.12	1.11	1.12	1.01	1.01	1.02	1.02
4200	0.11	0.11	0.10	0.11	86.80	92.96	96.84	86.63	1.14	1.14	1.13	1.12	1.13	1.01	1.01	1.02	1.02
4400	0.12	0.12	0.11	0.11	89.51	88.52	95.95	119.85	1.15	1.15	1.14	1.13	1.14	1.01	1.01	1.03	1.02
4600	0.12	0.12	0.11	0.11	101.30	90.92	88.88	101.47	1.15	1.16	1.14	1.13	1.15	1.02	1.01	1.03	1.01
4800	0.12	0.12	0.11	0.12	92.95	89.76	88.03	90.42	1.16	1.17	1.15	1.14	1.16	1.02	1.01	1.04	1.01
5000	0.13	0.13	0.12	0.12	93.00	87.32	97.78	86.57	1.17	1.18	1.16	1.14	1.17	1.03	1.02	1.04	1.02
5200	0.13	0.13	0.12	0.13	89.41	87.14	95.79	96.85	1.17	1.18	1.16	1.15	1.17	1.04	1.02	1.05	1.02
5400	0.13	0.13	0.12	0.12	90.92	91.23	85.21	92.25	1.18	1.19	1.17	1.15	1.18	1.04	1.03	1.06	1.03
5600	0.13	0.13	0.12	0.13	81.63	92.75	88.95	97.64	1.18	1.19	1.17	1.16	1.18	1.05	1.04	1.07	1.04
5800	0.14	0.14	0.12	0.13	87.63	88.84	93.62	97.05	1.18	1.19	1.17	1.16	1.19	1.06	1.04	1.08	1.05
6000	0.14	0.14	0.12	0.13	97.00	90.58	82.71	85.39	1.18	1.19	1.17	1.16	1.19	1.07	1.05	1.08	1.05
6200	0.14	0.14	0.12	0.13	84.01	95.05	91.54	89.31	1.18	1.19	1.17	1.16	1.19	1.08	1.06	1.09	1.06
6400	0.14	0.14	0.13	0.13	86.32	83.68	101.11	85.54	1.18	1.19	1.17	1.15	1.19	1.08	1.07	1.10	1.07
6600	0.14	0.14	0.12	0.13	90.12	85.71	93.07	88.22	1.18	1.19	1.17	1.15	1.19	1.09	1.08	1.11	1.08
6800	0.14	0.14	0.12	0.13	90.17	96.89	104.28	93.31	1.18	1.19	1.17	1.15	1.19	1.10	1.08	1.12	1.09
7000	0.14	0.14	0.12	0.13	96.29	88.25	92.07	91.13	1.18	1.18	1.16	1.14	1.19	1.11	1.09	1.12	1.10
7200	0.14	0.14	0.12	0.13	93.31	83.18	101.92	95.52	1.17	1.18	1.16	1.14	1.19	1.11	1.10	1.13	1.11
7400	0.14	0.14	0.13	0.14	85.32	94.84	93.28	89.76	1.17	1.18	1.15	1.13	1.18	1.12	1.10	1.13	1.11
7600	0.14	0.14	0.13	0.14	85.61	86.68	87.39	107.82	1.16	1.17	1.15	1.13	1.18	1.12	1.11	1.14	1.12
7800	0.14	0.14	0.13	0.14	92.83	96.67	97.37	97.06	1.16	1.17	1.14	1.13	1.18	1.13	1.11	1.14	1.13
8000	0.15	0.15	0.13	0.14	84.29	88.90	110.84	92.70	1.16	1.17	1.13	1.12	1.17	1.13	1.12	1.15	1.14
8200	0.15	0.15	0.13	0.14	94.82	95.84	96.65	95.91	1.16	1.16	1.13	1.12	1.17	1.13	1.13	1.15	1.14
8400	0.15	0.15	0.13	0.14	92.86	94.08	88.43	88.50	1.16	1.16	1.12	1.11	1.17	1.14	1.13	1.15	1.15
8600	0.15	0.15	0.13	0.14	93.21	94.46	93.01	85.05	1.16	1.16	1.11	1.11	1.16	1.14	1.13	1.15	1.15
8800	0.15	0.15	0.13	0.14	96.88	88.50	92.33	90.87	1.16	1.16	1.11	1.11	1.16	1.14	1.14	1.16	1.16
9000	0.15	0.15	0.13	0.14	92.45	96.71	90.03	83.88	1.16	1.16	1.11	1.11	1.16	1.14	1.14	1.16	1.16
9200	0.15	0.15	0.13	0.14	95.06	97.51	90.74	88.34	1.17	1.16	1.10	1.11	1.15	1.14	1.14	1.16	1.16
9400	0.15	0.15	0.14	0.14	121.14	89.27	87.28	87.98	1.17	1.16	1.10	1.11	1.15	1.14	1.14	1.16	1.17
9600	0.15	0.15	0.14	0.14	96.68	89.85	97.46	90.78	1.17	1.16	1.10	1.12	1.15	1.14	1.15	1.16	1.17
9800	0.16	0.16	0.14	0.14	92.89	92.24	93.44	91.91	1.17	1.16	1.10	1.12	1.15	1.13	1.15	1.16	1.17
10000	0.16	0.16	0.14	0.14	89.30	87.70	104.55	84.58	1.17	1.16	1.10	1.12	1.14	1.13	1.15	1.15	1.17
12000	0.15	0.15	0.14	0.14	90.01	84.97	93.20	99.57	1.10	1.11	1.07	1.08	1.08	1.14	1.18	1.18	1.17
14000	0.16	0.16	0.15	0.15	89.07	101.03	95.89	113.83	1.05	1.05	1.03	1.05	1.05	1.25	1.27	1.29	1.24
16000	0.21	0.21	0.19	0.19	86.37	97.23	88.91	84.43	1.20	1.20	1.13	1.16	1.19	1.35	1.35	1.37	1.34
18000	0.26	0.26	0.22	0.24	84.28	89.79	107.24	89.61	1.29	1.30	1.19	1.22	1.29	1.29	1.31	1.30	1.33
20000	0.29	0.29	0.25	0.27	87.96	89.06	91.38	85.51	1.31	1.34	1.23	1.26	1.34	1.15	1.16	1.13	1.21
22000	0.30	0.30	0.28	0.29	88.43	89.79	81.05	86.39	1.27	1.26	1.20	1.22	1.27	1.05	1.01	1.04	1.10
24000	0.26	0.26	0.25	0.24	85.01	88.19	94.35	89.99	1.23	1.23	1.21	1.22	1.21	1.10	1.14	1.15	1.09
26000	0.25	0.25	0.26	0.23	95.48	94.53	96.07	92.23	1.21	1.19	1.24	1.25	1.19	1.18	1.25	1.24	1.15
28000	0.29	0.29	0.28	0.27	78.93	83.83	82.49	85.07	1.25	1.25	1.26	1.25	1.24	1.27	1.34	1.32	1.23
30000	0.35	0.35	0.29	0.32	95.64	82.32	78.42	89.53	1.36	1.34	1.26	1.22	1.31	1.29	1.34	1.32	1.29
32000	0.35	0.35	0.27	0.32	91.22	79.43	104.80	84.35	1.31	1.32	1.18	1.11	1.29	1.28	1.29	1.27	1.33
34000	0.34	0.34	0.29	0.31	73.28	69.98	72.21	70.47	1.23	1.21	1.07	1.07	1.18	1.28	1.24	1.23	1.33
36000	0.37	0.37	0.35	0.33	72.89	73.13	88.04	78.41	1.23	1.21	1.18	1.19	1.15	1.21	1.14	1.24	1.27
38000	0.36	0.36	0.37	0.34	84.33	76.16	73.14	89.43	1.07	1.10	1.17	1.21	1.01	1.21	1.10	1.16	1.29
40000	0.49	0.49	0.60	0.45	82.84	83.76	79.94	79.16	1.34	1.37	1.48	1.59	1.35	1.14	1.17	1.21	1.29



P.O. Box 350166, Brooklyn, New York 11235-0003 (718) 934-4500 • Fax (718) 332-4661 For detailed performance specs & shopping online see Mini-Circuits web site  
 The Design Engineers Search Engine Provides ACTUAL Data Instantly From MINI-CIRCUITS At: www.minicircuits.com

IF/RF MICROWAVE COMPONENTS

## Typical Performance Data

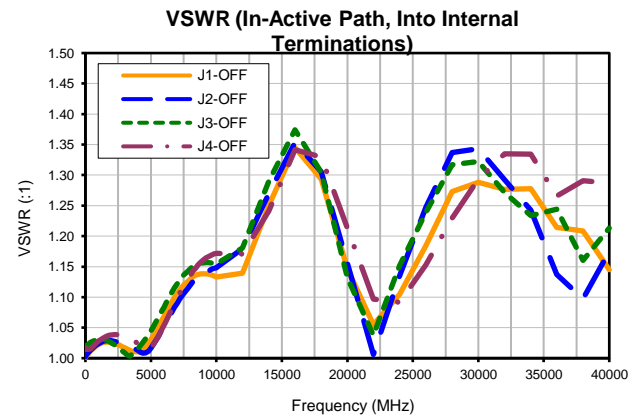
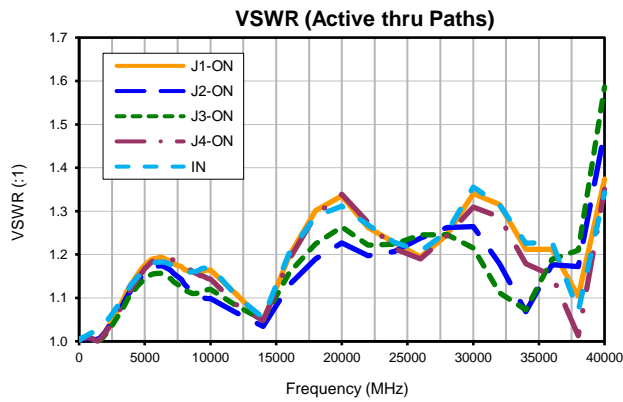
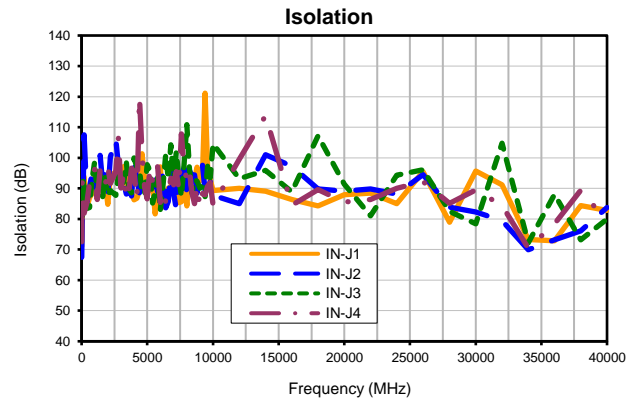
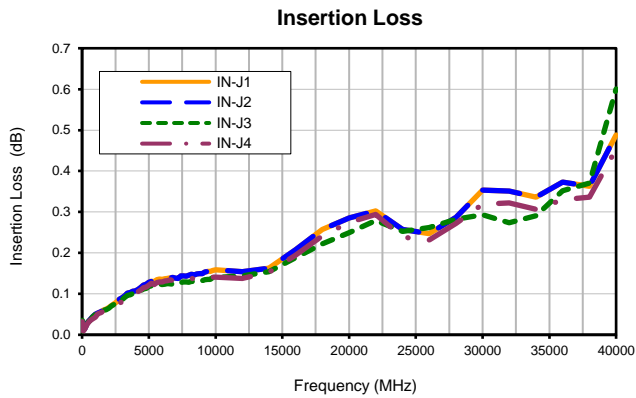

## Outline Dimensions

MR2935

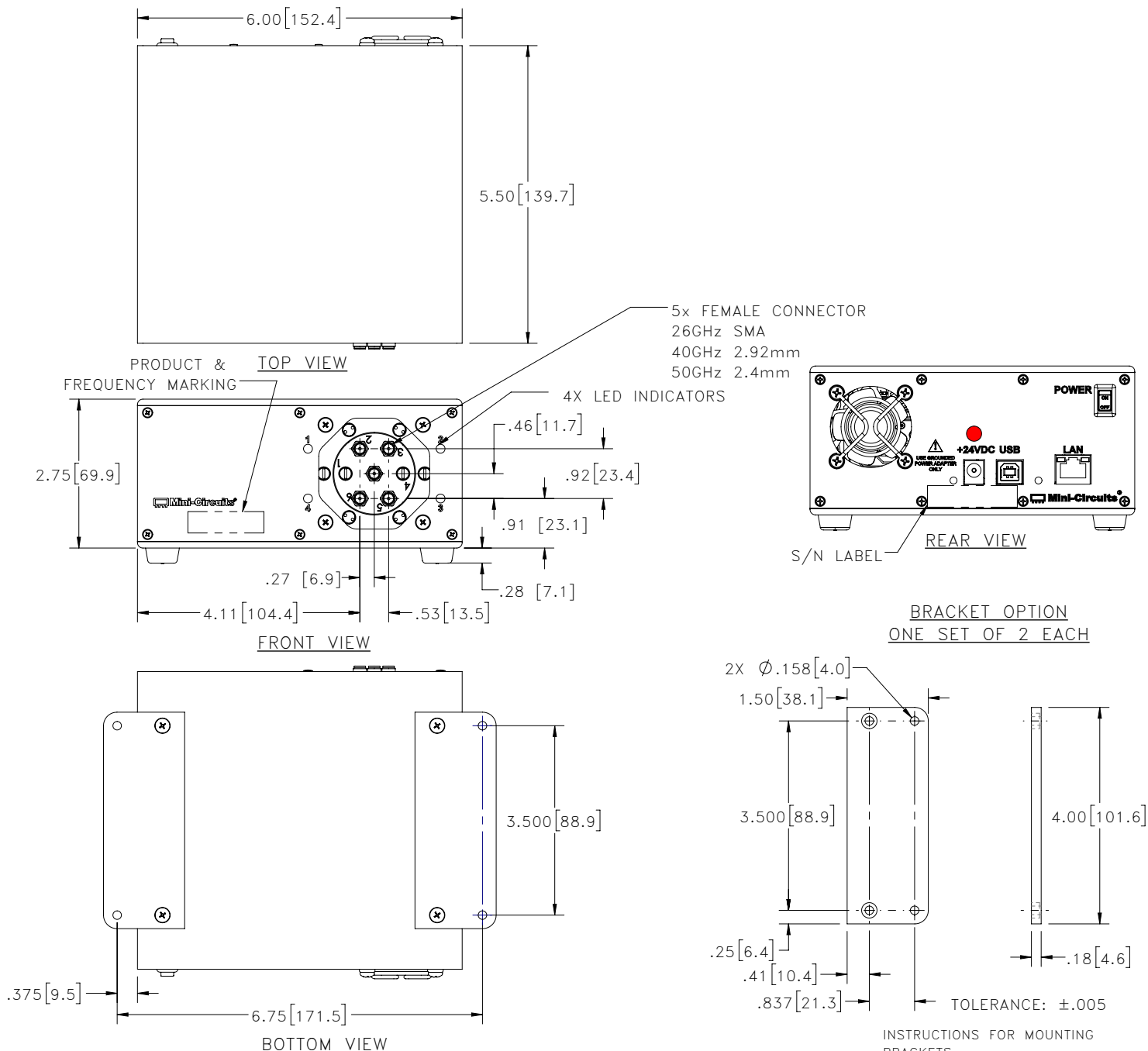

### Notes:

1. Case material: Aluminum (with protective coating to prevent corrosion).
2. Dimensions are in inches (mm). Tolerances: 2 Pl.  $\pm$ .03 inch; 3 Pl.  $\pm$ .015 inch.
3. Weight: 1060 grams.
4. Marking may contain other features or characters for internal lot control.

INSTRUCTIONS FOR MOUNTING BRACKETS:  
TOOL REQUIRED: PHILLIPS HEAD SCREWDRIVER  
STEP 1: REMOVE RUBBER FEET FROM THE BOTTOM OF THE UNIT, DO NOT DISCARD THE FASTENERS.  
STEP 2: MOUNT THE BRACKETS WITH THE FASTENERS REMOVED IN STEP 1, USING THE COUNTER BORE HOLES IN THE BRACKET.

**Mini-Circuits**  
ISO 9001 ISO 14001 CERTIFIED

ALL NEW  
minicircuits.com

P.O. Box 350166, Brooklyn, New York 11235-0003 (718) 934-4500 Fax (718) 332-4661 For detailed performance specs & shopping online see Mini-Circuits web site



The Design Engineers Search Engine Provides ACTUAL Data Instantly From MINI-CIRCUITS At: [www.minicircuits.com](http://www.minicircuits.com)

RF/IF MICROWAVE COMPONENTS



All Mini-Circuits products are manufactured under exacting quality assurance and control standards, and are capable of meeting published specifications after being subjected to any or all of the following physical and environmental test.

Specification	Test/Inspection Condition	Reference/Spec
Operating Temperature	0° to 40° C Ambient Environment	Individual Model Data Sheet
Storage Temperature	-15° to 85°C Ambient Environment	Individual Model Data Sheet
Operating and Storage Humidity	5% to 85% RH (non-condensing)	Ambient
Bench Handling Test	Bench Top Tip 45° & Drop	MIL-PRF-28800F
Transit Drop Test	Free Fall Drop, 20 cm (7.9 inches)	MIL-PRF-28800F class 3