



USB & ETHERNET CONTROLLED

RF Transfer Switch Matrix RC-3MTS-26

50Ω DC to 26.5 GHz SMA-Female

THE BIG DEAL

- Three mechanical transfer switches
- Wideband performance up to 26.5 GHz
- High reliability, 2 million switch cycles
- High isolation

APPLICATIONS

- 5G node / device testing
- Automated test equipment
- Fail-safe / redundancy switching
- Switch matrices



CASE STYLE: SH3143

[DOWNLOAD](#) SOFTWARE PACKAGE

RoHS Compliant
See our website for RoHS Compliance methodologies and qualifications

PRODUCT OVERVIEW

Mini-Circuits' RC-3MTS-26 comprises of three independently controlled, electro-mechanical transfer switches. Each switch operates over a wide bandwidth, from DC to 26.5 GHz with high isolation (80 dB typical), low insertion loss (0.3 dB typical) and high input power rating. The switches are of a fail-safe and break-before-make-configuration, with a minimum life time of 2 million switching cycles when used within the noted specifications.

The switch box is constructed in a compact, rugged metal case (4.5 x 6.0 x 2.25") with all SMA(f) RF connectors on the front panel. The switches are controlled via USB or Ethernet, allowing control directly from a PC, or remotely over a network. Full software support is provided, including our user-friendly GUI application for Windows and a full API with programming instructions for Windows and Linux environments (both 32-bit and 64-bit systems).

KEY FEATURES

Feature	Advantages
Three transfer switches	Transfer switches provide a simple DPDT switch application (2 input to 2 output switch matrix) and are a useful building block in much larger switch matrices
Fail-safe design	The switches revert to a known default state when the DC supply is removed, allowing their use in systems that must continue to operate safely in the event of power failure
Break-before-make configuration	Prevents a momentary connection of the old and new signal paths, reducing the inconsistent transient effects that could otherwise be observed during switching
USB & Ethernet control	USB HID and Ethernet (HTTP / Telnet) interfaces provide easy compatibility with a wide range of software setups and programming environments
Full software support	User friendly Windows GUI (graphical user interface) allows manual control straight out of the box, while the comprehensive API (application programming interface) with examples and instructions allows easy automation in most programming environments

REV. B
ECO-009638
RC-3MTS-26
MCL NY
240226





USB & ETHERNET CONTROLLED

RF Transfer Switch Matrix RC-3MTS-26

50Ω DC to 26.5 GHz SMA-Female

ELECTRICAL SPECIFICATIONS AT 25°C

Parameter	Conditions (GHz)	Min.	Typ.	Max.	Units
Frequency Range		DC		26.5	GHz
Insertion Loss	DC - 8	—	0.15	0.30	dB
	8 - 12	—	0.20	0.40	
	12 - 18	—	0.30	0.50	
	18 - 26.5	—	0.50	0.70	
Isolation	DC - 8	70	90	—	dB
	8 - 12	65	80	—	
	12 - 18	60	80	—	
	18 - 26.5	50	70	—	
VSWR	DC - 8	—	1.30		:1
	8 - 12	—	1.40		
	12 - 18	—	1.50		
	18 - 26.5	—	1.70		
Switching Time	—	—	25	—	ms
RF Input Power (Cold Switching) ¹	DC - 8			20	W
	8 - 12			10	
	18 - 26.5			5	
Switch Lifetime (per Switch)	<0.1W hot switching ²	2	—	—	million cycles
	0.1 - 1W hot switching	—	1	—	
Rated Voltage	24V _{DC} input	23	24	25	V
	USB port	—	5	—	
Rated Current (24V DC Input)	All switches in state 2	—	530	840	mA
	All switches in state 1	—	90	120	
Rated Current (USB)		—	10	20	mA

1. Maximum power per path, with all ports terminated into 50Ω

2. Hot switching power above this level will degrade the switch lifetime.

ABSOLUTE MAXIMUM RATINGS

Parameters	Ratings
Operating Temperature	0°C to 40°C
Storage Temperature	-15°C to 85°C
Supply Voltage	26V



USB & ETHERNET CONTROLLED

RF Transfer Switch Matrix RC-3MTS-26

50Ω DC to 26.5 GHz SMA-Female

SWITCHING STATES (PER SWITCH)



CONNECTIONS

Port Name	Connector Type
RF Switch A (J1, J2, J3 & J4)	SMA female
RF Switch B (J1, J2, J3 & J4)	SMA female
RF Switch C (J1, J2, J3 & J4)	SMA female
USB	USB type-B
Ethernet / LAN	RJ45
24V _{DC} Input	2.1mm center positive DC socket

OUTLINE DRAWING (SH3143)

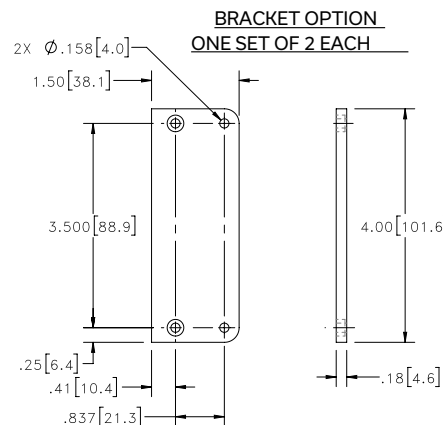
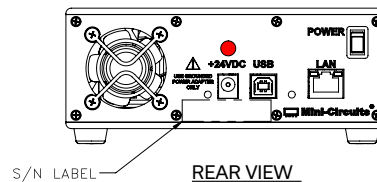
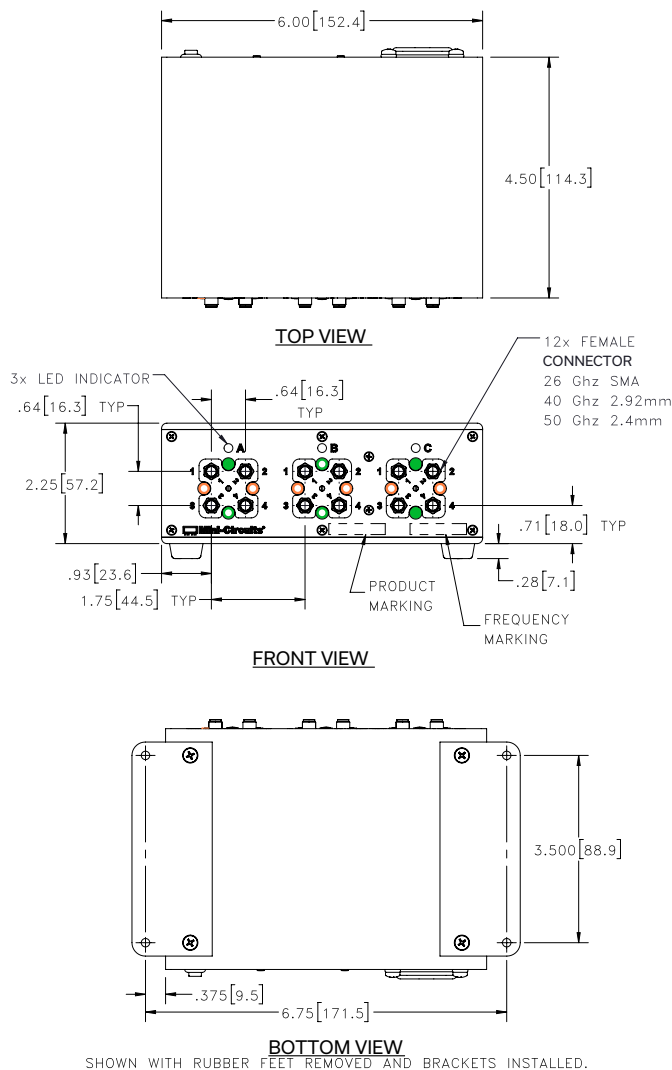

Weight: 960 grams
 Dimensions are in inches [mm]. Tolerances: 2 Pl. ±.03 inch; 3Pl. ±.015 inch

INSTRUCTIONS FOR MOUNTING BRACKETS:
 TOOL REQUIRED: PHILLIPS HEAD SCREWDRIVER
 STEP 1: REMOVE RUBBER FEET FROM THE BOTTOM OF THE UNIT. DO NOT DISCARD THE FASTENERS.
 STEP 2: MOUNT THE BRACKETS WITH THE FASTENERS REMOVED IN STEP 1. USING THE COUNTER BORE HOLES IN THE BRACKET.





USB & ETHERNET CONTROLLED

RF Transfer Switch Matrix **RC-3MTS-26**

Mini-Circuits

50Ω DC to 26.5 GHz SMA-Female

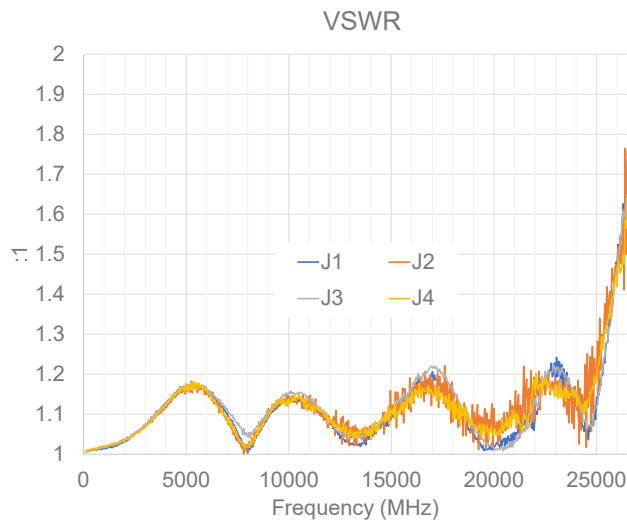
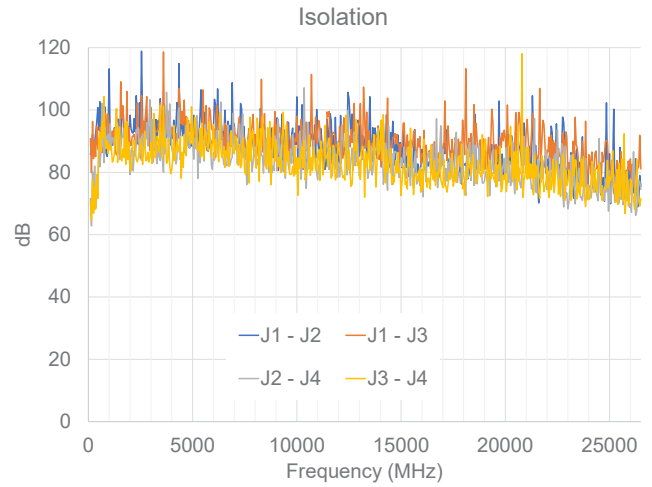
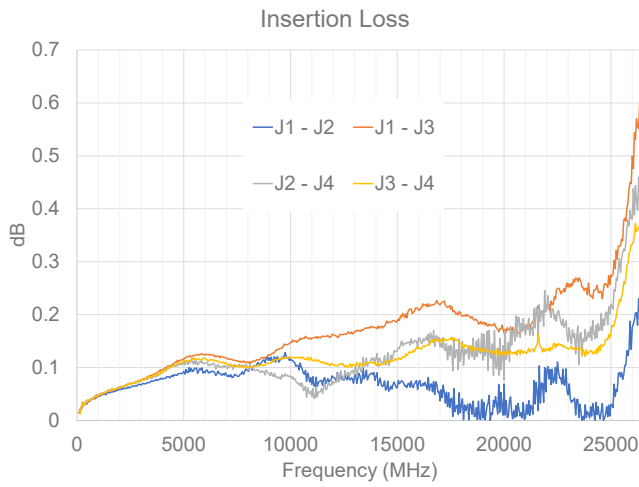



USB & ETHERNET CONTROLLED

RF Transfer Switch Matrix **RC-3MTS-26**

50Ω DC to 26.5 GHz SMA-Female

SOFTWARE SPECIFICATIONS

SOFTWARE & DOCUMENTATION DOWNLOAD:

- Mini-Circuits' full software and support package including user guide, Windows GUI, DLL files, programming manual and examples can be downloaded free of charge from: <https://www.minicircuits.com/softwaredownload/rfswitchcontroller.html>
- Please contact testsolutions@minicircuits.com for support

MINIMUM SYSTEM REQUIREMENTS:

Parameter	Requirements	
Interface	USB HID & Ethernet (HTTP & Telnet)	
System Requirements	GUI	Windows 98 or later
	USB API DLL	Windows 98 or later and programming environment with ActiveX or .NET support
	USB Direct Programming	Linux, Windows 98 or later
	Ethernet	Windows, Linux or Mac computer with a network port and Ethernet TCP/IP support
Hardware	Pentium II or later with 256 MB RAM	

APPLICATION PROGRAMMING INTERFACE (API)

ETHERNET SUPPORT:

- Simple ASCII / SCPI command set for attenuator control
- Communication via HTTP or Telnet
- Supported by most common programming environment

USB SUPPORT (WINDOWS):

- ActiveX COM DLL file for creation of 32-bit programs
- .NET library DLL file for creation of 32 / 64-bit programs
- Supported by most common programming environments (refer to application note AN-49-001 for summary of supported environments)

USB SUPPORT (LINUX):

- Direct USB programming using a series of USB interrupt codes

Full programming instructions and examples available for a wide range of programming environments / languages.



GRAPHICAL USER INTERFACE (GUI) FOR WINDOWS - KEY FEATURES

- Connect via USB or Ethernet
- Run GUI in "demo mode" to evaluate software without a hardware connection

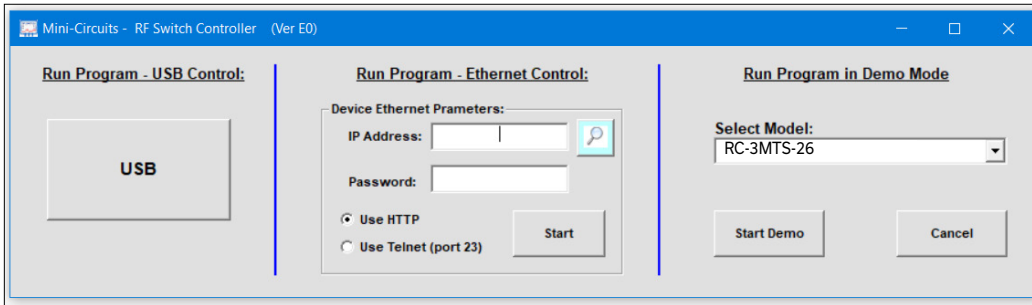

- View and set switch states at the click of a button
- Configure and run timed switching sequences
- Set start-up switch state
- Configure Ethernet IP settings

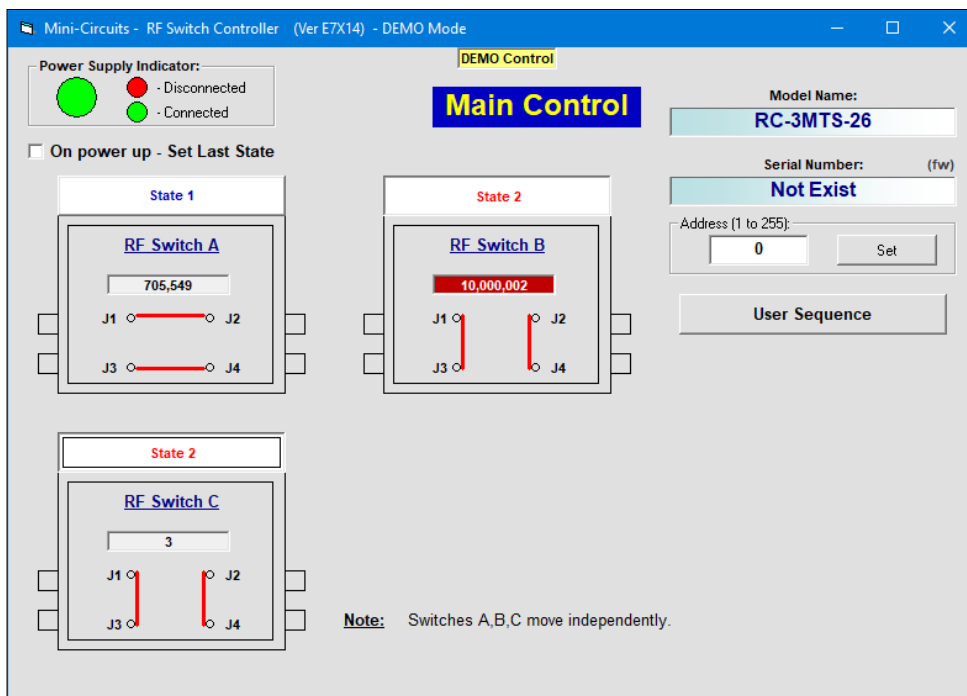



USB & ETHERNET CONTROLLED

RF Transfer Switch Matrix **RC-3MTS-26**



50Ω DC to 26.5 GHz SMA-Female





ORDERING INFORMATION

Refer to Mini-Circuits' website for pricing and availability information:

<https://www.minicircuits.com/WebStore/dashboard.html?model=RC-3MTS-26>

Model	Description
RC-3MTS-26	USB & Ethernet controlled transfer switch matrix

Included Accessories	Part No.	Description
	AC/DC-24-3W1	AC/DC 24V _{DC} Grounded Power Adaptor. Operating temperature: 0°C to +40°C, I _{Max} =2.5A
See Below	CBL-3W1-XX	AC Power Cord (Select one power cord from below with each Switch Matrix box)
	USB-CBL-AB-3+	2.7 ft (0.8 m) USB Cable: USB type A(Male) to USB type B(Male)

AC Power Cords ³	Part No.	Description
	CBL-3W1-US	Power Cord for United States
	CBL-3W1-EU	Power Cord for Europe
	CBL-3W1-UK	Power Cord for United Kingdom
	CBL-3W1-AU	Power Cord for Australia and China
	CBL-3W1-IL	Power Cord for Israel

3. If you need a Power cord for a country not listed please contact testsolutions@minicircuits.com

OPTIONAL ACCESSORIES

USB-CBL-AB-3+	2.7 ft (0.8 m) USB Cable: USB type A(Male) to USB type B(Male)
USB-CBL-AB-7+	6.8 ft (2.1 m) USB Cable: USB type A(Male) to USB type B(Male)
USB-CBL-AB-11+	11 ft (3.4 m) USB Cable: USB type A(Male) to USB type B(Male)
CBL-RJ45-MM-5+	5 ft (1.5 m) Ethernet cable: RJ45(Male) to RJ45(Male) Cat 5E cable
BKT-272-08+	Bracket (One set of 2 each)

- NOTES**
- A. Performance and quality attributes and conditions not expressly stated in this specification document are intended to be excluded and do not form a part of this specification document.
 - B. Electrical specifications and performance data contained in this specification document are based on Mini-Circuit's applicable established test performance criteria and measurement instructions.
 - C. The parts covered by this specification document are subject to Mini-Circuits standard limited warranty and terms and conditions (collectively, "Standard Terms"); Purchasers of this part are entitled to the rights and benefits contained therein. For a full statement of the standard. Terms and the exclusive rights and remedies thereunder, please visit Mini-Circuits' website at www.minicircuits.com/MCLStore/terms.jsp



Typical Performance Data per Switch

FREQUENCY (MHz)	INSERTION LOSS (ON)				ISOLATION (OFF)				VSWR (ENERGIZED)				VSWR (DE-ENERGIZED)			
	(dB)				(dB)				(:1)				(:1)			
	J1-J2	J1-J3	J2-J4	J3-J4	J1-J2	J1-J3	J2-J4	J3-J4	J1	J2	J3	J4	J1	J2	J3	J4
100	0.01	0.01	0.02	0.02	85.67	90.83	71.60	70.55	1.00	1.01	1.00	1.01	1.01	1.01	1.01	1.01
500	0.03	0.04	0.04	0.04	93.57	86.78	89.26	90.27	1.01	1.01	1.01	1.01	1.01	1.01	1.01	1.01
700	0.04	0.04	0.04	0.04	94.82	87.76	91.79	90.96	1.01	1.02	1.01	1.02	1.02	1.02	1.01	1.01
750	0.04	0.04	0.04	0.04	86.77	92.25	83.15	104.28	1.01	1.01	1.02	1.02	1.02	1.01	1.01	1.01
800	0.04	0.04	0.04	0.04	100.99	98.91	94.28	90.70	1.01	1.02	1.01	1.02	1.02	1.02	1.01	1.01
1000	0.05	0.05	0.05	0.05	113.21	90.07	87.86	89.13	1.02	1.02	1.02	1.02	1.02	1.02	1.02	1.02
1500	0.05	0.06	0.06	0.06	92.71	86.28	84.02	94.61	1.02	1.03	1.02	1.03	1.03	1.03	1.02	1.02
2000	0.06	0.06	0.06	0.06	98.35	88.73	79.29	81.84	1.03	1.04	1.04	1.03	1.03	1.03	1.03	1.03
2500	0.06	0.07	0.07	0.07	92.52	84.45	90.84	90.42	1.05	1.05	1.06	1.05	1.04	1.04	1.05	1.05
3000	0.07	0.08	0.08	0.08	97.47	100.79	89.88	89.69	1.07	1.07	1.07	1.07	1.06	1.06	1.07	1.07
3500	0.07	0.09	0.08	0.08	89.16	95.90	92.81	90.19	1.10	1.09	1.10	1.09	1.08	1.08	1.09	1.09
4000	0.08	0.10	0.09	0.09	93.91	94.48	87.67	80.97	1.13	1.12	1.13	1.12	1.12	1.11	1.12	1.12
4500	0.08	0.11	0.10	0.10	94.29	99.53	85.63	86.45	1.15	1.14	1.15	1.15	1.14	1.14	1.14	1.14
5000	0.09	0.12	0.11	0.11	88.87	91.92	90.19	88.79	1.16	1.17	1.16	1.18	1.17	1.17	1.15	1.16
5500	0.10	0.12	0.11	0.12	98.26	106.48	87.47	85.78	1.17	1.17	1.17	1.18	1.17	1.17	1.16	1.16
6000	0.09	0.12	0.11	0.12	94.52	91.13	86.30	95.28	1.16	1.15	1.16	1.16	1.14	1.14	1.14	1.14
6500	0.08	0.12	0.10	0.11	91.48	87.95	82.39	88.24	1.13	1.12	1.14	1.12	1.11	1.12	1.12	1.12
7000	0.09	0.12	0.10	0.11	95.55	94.44	87.88	86.03	1.10	1.09	1.11	1.09	1.08	1.09	1.09	1.09
7500	0.08	0.11	0.10	0.10	90.15	90.37	86.39	80.23	1.06	1.04	1.07	1.04	1.03	1.05	1.04	1.05
8000	0.09	0.11	0.10	0.10	90.52	92.12	87.02	85.01	1.00	1.01	1.04	1.02	1.02	1.02	1.00	1.02
8500	0.11	0.11	0.10	0.10	90.32	88.76	82.23	82.15	1.05	1.05	1.07	1.05	1.08	1.06	1.04	1.05
9000	0.12	0.12	0.09	0.11	90.81	88.09	89.98	90.41	1.09	1.11	1.10	1.10	1.13	1.14	1.08	1.08
9500	0.11	0.14	0.08	0.12	85.88	84.39	89.35	95.21	1.12	1.12	1.13	1.13	1.16	1.16	1.11	1.11
10000	0.12	0.15	0.08	0.12	104.23	98.02	83.61	84.72	1.14	1.15	1.15	1.14	1.17	1.19	1.13	1.13
10500	0.10	0.15	0.06	0.12	84.12	86.82	83.83	80.86	1.13	1.14	1.15	1.15	1.18	1.21	1.12	1.12
11000	0.07	0.16	0.05	0.11	91.35	92.85	77.66	85.73	1.12	1.11	1.14	1.13	1.15	1.15	1.11	1.11
11500	0.07	0.16	0.05	0.11	93.89	98.02	86.26	81.73	1.10	1.10	1.11	1.11	1.13	1.14	1.09	1.09
12000	0.08	0.16	0.07	0.11	89.98	85.58	83.10	89.57	1.08	1.08	1.08	1.08	1.10	1.10	1.06	1.06
12500	0.08	0.16	0.08	0.10	103.74	91.67	83.14	87.14	1.04	1.06	1.05	1.06	1.06	1.06	1.04	1.04
13000	0.08	0.17	0.09	0.10	85.22	96.24	78.85	80.78	1.03	1.07	1.05	1.06	1.07	1.07	1.03	1.03
13500	0.08	0.17	0.10	0.11	104.27	87.70	81.86	80.53	1.02	1.06	1.05	1.06	1.07	1.07	1.04	1.03
14000	0.08	0.18	0.12	0.10	88.62	88.46	89.16	90.41	1.04	1.04	1.06	1.04	1.06	1.04	1.05	1.04
14500	0.06	0.19	0.11	0.11	92.76	85.23	79.86	87.61	1.07	1.07	1.08	1.08	1.10	1.09	1.07	1.06
15000	0.06	0.19	0.13	0.11	88.07	89.11	84.71	72.57	1.10	1.09	1.10	1.10	1.13	1.10	1.10	1.10
15500	0.07	0.20	0.15	0.12	84.09	89.76	88.62	82.26	1.13	1.10	1.14	1.11	1.12	1.08	1.14	1.13
16000	0.07	0.21	0.16	0.14	87.30	85.93	81.04	80.34	1.15	1.16	1.16	1.16	1.16	1.14	1.16	1.16
16500	0.06	0.22	0.14	0.14	81.40	88.98	85.07	79.31	1.17	1.18	1.19	1.16	1.18	1.16	1.18	1.18
17000	0.04	0.22	0.14	0.15	87.08	86.45	87.42	75.04	1.21	1.19	1.22	1.15	1.17	1.19	1.19	1.18
17500	0.04	0.21	0.14	0.15	86.37	84.35	76.97	75.53	1.16	1.18	1.20	1.15	1.16	1.21	1.19	1.17
18000	0.03	0.20	0.13	0.15	82.79	91.38	79.03	76.51	1.13	1.08	1.16	1.09	1.11	1.13	1.16	1.15
18500	0.01	0.20	0.12	0.14	82.74	101.72	75.76	81.33	1.09	1.05	1.11	1.10	1.09	1.09	1.12	1.12
19000	0.00	0.18	0.11	0.14	90.03	80.99	77.11	89.40	1.03	1.03	1.07	1.07	1.05	1.09	1.09	1.09
19500	0.04	0.18	0.09	0.13	88.72	83.25	82.49	76.84	1.01	1.08	1.03	1.06	1.04	1.04	1.06	1.05
20000	0.07	0.17	0.08	0.13	81.75	90.89	77.88	79.70	1.02	1.12	1.01	1.06	1.05	1.03	1.04	1.04
20500	0.01	0.17	0.15	0.13	79.40	99.18	81.78	86.79	1.04	1.10	1.02	1.07	1.05	1.02	1.04	1.04
21000	0.01	0.18	0.16	0.13	83.31	93.33	87.85	87.92	1.04	1.12	1.03	1.10	1.03	1.02	1.05	1.05
21500	0.07	0.20	0.21	0.14	85.10	85.07	73.42	81.72	1.08	1.10	1.06	1.10	1.05	1.07	1.09	1.09
22000	0.09	0.22	0.21	0.13	84.26	87.11	74.52	81.77	1.09	1.08	1.14	1.15	1.13	1.21	1.11	1.11
22500	0.11	0.25	0.20	0.14	83.50	84.07	93.72	81.04	1.20	1.15	1.21	1.18	1.22	1.17	1.16	1.18
23000	0.05	0.25	0.15	0.14	82.96	80.65	68.27	76.66	1.19	1.19	1.20	1.15	1.18	1.23	1.17	1.18
23500	0.01	0.27	0.11	0.13	76.80	83.89	80.17	76.65	1.18	1.13	1.19	1.13	1.18	1.28	1.14	1.15
24000	0.00	0.24	0.16	0.13	82.33	85.66	75.87	71.18	1.14	1.12	1.15	1.16	1.17	1.21	1.09	1.10
24500	0.00	0.24	0.17	0.13	77.83	77.60	90.87	82.85	1.04	1.02	1.07	1.11	1.09	1.17	1.08	1.04
25000	0.03	0.27	0.22	0.16	85.96	76.51	80.52	78.52	1.14	1.20	1.12	1.18	1.12	1.03	1.18	1.13
25500	0.09	0.34	0.31	0.23	87.99	78.65	80.87	72.22	1.28	1.42	1.28	1.33	1.23	1.29	1.36	1.28
26000	0.18	0.50	0.38	0.33	80.56	84.32	69.96	77.88	1.47	1.44	1.47	1.42	1.40	1.39	1.53	1.45
26500	0.23	0.61	0.51	0.42	75.55	81.12	74.53	71.59	1.65	1.76	1.65	1.65	1.62	1.63	1.63	1.61

Typical Performance Curves per Switch

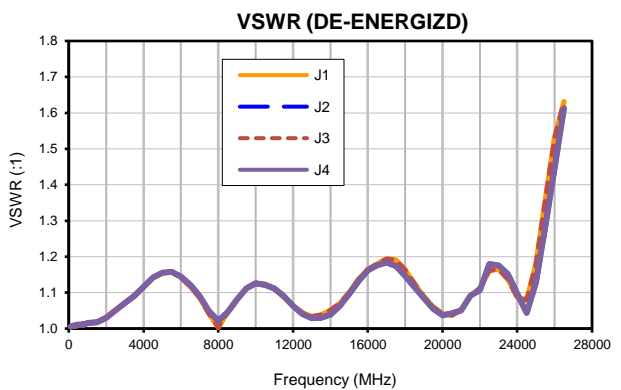
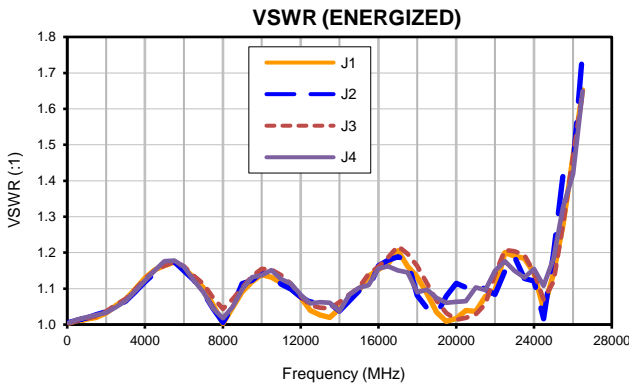
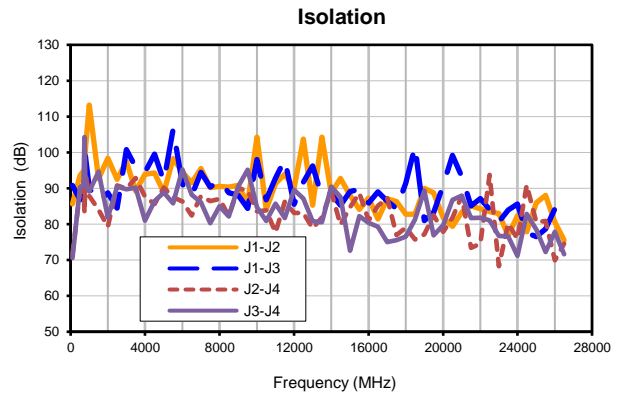
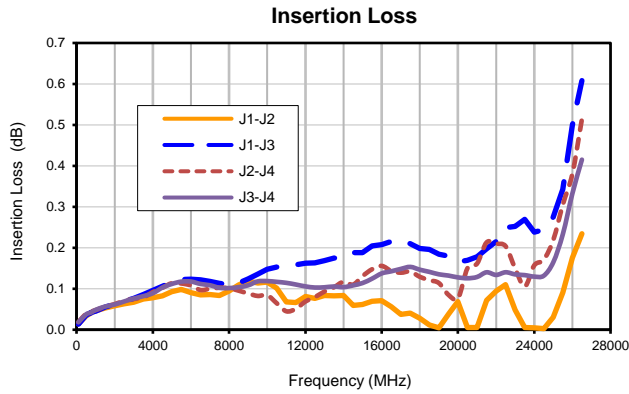

Outline Dimensions

SH3143

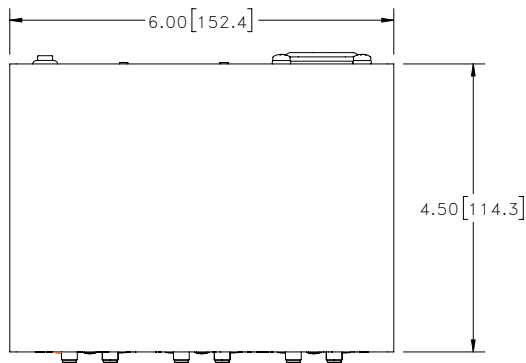

TOP VIEW

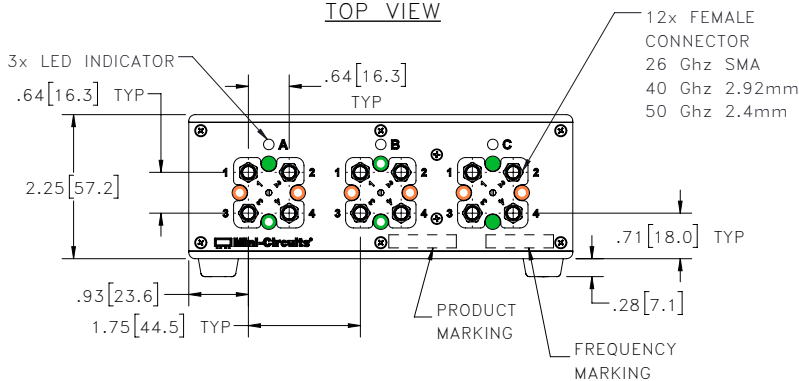

FRONT VIEW

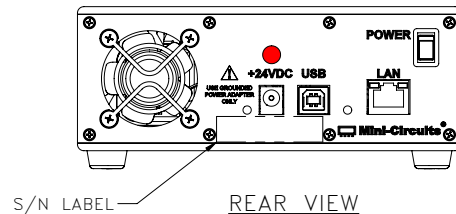

BRACKET OPTION

ONE SET OF 2 EACH

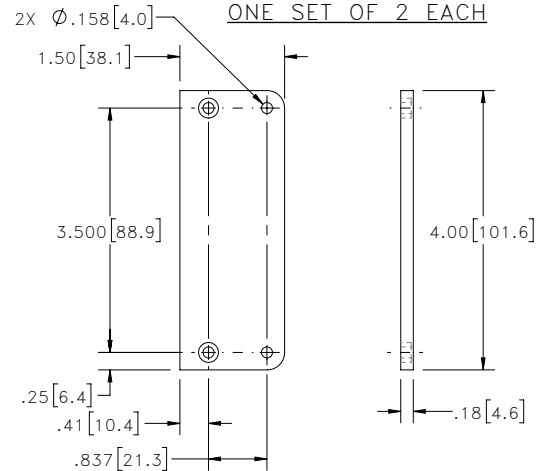

TOLERANCE: ±.005

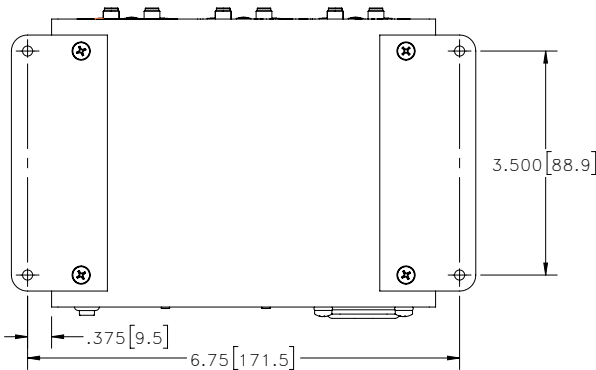

BOTTOM VIEW

SHOWN WITH RUBBER FEET REMOVED AND BRACKETS INSTALLED.

Notes:

1. Case material: Aluminum (with protective coating to prevent corrosion).
2. Dimensions are in inches [mm]. Tolerances: 2 Pl. ±.03 inch; 3 Pl. ±.015 inch.
3. Weight: 960 grams.
4. Marking may contain other features or characters for internal lot control.

INSTRUCTIONS FOR MOUNTING BRACKETS:
TOOL REQUIRED: PHILLIPS HEAD SCREWDRIVER
STEP 1: REMOVE RUBBER FEET FROM THE BOTTOM OF THE UNIT. DO NOT DISCARD THE FASTENERS.
STEP 2: MOUNT THE BRACKETS WITH THE FASTENERS REMOVED IN STEP 1, USING THE COUNTER BORE HOLES IN THE BRACKET.



P.O. Box 350166, Brooklyn, New York 11235-0003 (718) 934-4500 Fax (718) 332-4661 For detailed performance specs & shopping online see Mini-Circuits web site



The Design Engineers Search Engine Provides ACTUAL Data Instantly From MINI-CIRCUITS At: www.minicircuits.com

RF/IF MICROWAVE COMPONENTS



All Mini-Circuits products are manufactured under exacting quality assurance and control standards, and are capable of meeting published specifications after being subjected to any or all of the following physical and environmental test.

Specification	Test/Inspection Condition	Reference/Spec
Operating Temperature	-55° to 100°C Ambient Environment	Individual Model Data Sheet
Storage Temperature	-55° to 100° C Ambient Environment	Individual Model Data Sheet
Thermal Shock	-55° to 100°C, 25 cycles	MIL-STD-202, Method 107, Condition A-1 except +100°C instead of 85°C
Vibration (High Frequency)	20g peak, 10-2000 Hz, 12 times in each of three perpendicular directions (total 36)	MIL-STD-202, Method 204, Condition D
Mechanical Shock	100g, 6ms sawtooth, 3 shocks each direction 3 axes (total 18)	MIL-STD-202, Method 213, Condition I
Connector Durability	500 mating/unmating cycles	MIL-PRF-39012E, PARAGRAPH 4.6.12