



Programmable Attenuator

RC4DAT-8G-95PE



50Ω 1 to 8000 MHz 0 to 95 dB 0.25 dB Step SMA Female

THE BIG DEAL

- Four independently programmable channels
- Over 100 dB Isolation between channels
- Repeatable 0-95 dB attenuation range
- SSH Secure Ethernet communication
- Power over Ethernet (PoE) per IEEE 802.3af

APPLICATIONS

- Wi-Fi 6E MIMO development
- LTE / 5G / IoT / Bluetooth / Zigbee
- Cellular handover testing
- C-band radar / satcom testing
- Automated signal sweeping / fading



Generic photo used for illustration purposes only

PRODUCT OVERVIEW

Mini-Circuits' RC4DAT-8G-95PE is a 4-channel programmable attenuator capable of supporting a wide range of signal level control applications from 1 MHz to 8 GHz. All 4 channels can be independently controlled with 0.25 dB attenuation resolution and more than 100 dB isolation between the channels. The dynamic range of each channel is 0 to 95 dB for applications up to 7.2 GHz and 0 to 90 dB up to 8 GHz. The unique attenuation design maintains linear attenuation change per dB, even at the highest attenuation settings.

All 4 bi-directional RF channels are housed in a single, compact and rugged package (3.00" x 5.17" x 0.60") with SMA female connectors on all RF ports. Ethernet (RJ45) with PoE and USB (type C) ports are both included to provide flexible control and DC supply options.

Full software support is provided, including our user-friendly GUI application for Windows and a full API with programming instructions for Windows and Linux environments (both 32-bit and 64-bit systems).

KEY FEATURES

Feature	Advantages
Programmable attenuation sequences	Configure timed sweep and hop sequences to run unaided without additional user interaction.
Wide attenuation range	Independently controllable 0-95 dB attenuators on each channel allow simulation of a wide range of test scenarios including receiver sensitivity, device / base-station handovers, device failures, and interference effects.
Safe attenuation transitions	Carefully synchronized attenuation transitions are implemented to prevent momentary reductions in attenuation whilst changing states, which would otherwise cause spikes in power level at the output.
Power over Ethernet (PoE)	Control and power the attenuator via a PoE network to simplify connections and allow remote attenuator operation over long Ethernet cable runs. Compliant with IEEE 802.3af mode A and mode B.
Secure Ethernet communication	Support for SSH (Secure Shell protocol) provides a means for secure communication over Ethernet networks with strict security policies. HTTP & Telnet communication via Ethernet are also supported.

Trademarks:

All trademarks cited within this document are the property of their respective owners. Neither Mini-Circuits nor the Mini-Circuits products are affiliated with or endorsed or sponsored by the owners of the referenced trademarks. Mini-Circuits and the Mini-Circuits logo are registered trademarks of Scientific Components Corporation.





ELECTRICAL SPECIFICATIONS¹, 25°C

Parameter	Conditions	Frequency (MHz)	Min.	Typ.	Max.	Unit
Attenuation Range	0.25 dB step	1 - 7200	0	-	95	dB
		7200 - 8000	0	-	90	
Attenuation Accuracy ²	0.25 - 20 dB	1 - 2000	-0.7	0.4	0.4+5.0% of setting	dB
		2000 - 4000	-0.7	1.0	0.4+5.0% of setting	
		4000 - 6000	-0.4-5.0% of setting	-0.2	0.75+4.0% of setting	
		6000 - 7200	-0.4-5.0% of setting	-0.5	0.7	
		7200 - 8000	-0.6-6.0% of setting	-0.6	0.3	
	20.25 - 60 dB	1 - 2000	-0.4-0.5% of setting	1.7	0.9+4.5% of setting	
		2000 - 4000	-0.7	1.0	0.8+4.5% of setting	
		4000 - 6000	-0.5-4.5% of setting	-0.6	1.2+2.0% of setting	
		6000 - 7200	-0.7-4.5% of setting	-1.8	0.7	
		7200 - 8000	-1.2-4.5% of setting	-2.1	0.3	
	60.25 - 80 dB	1 - 2000	-0.4-0.5% of setting	3.0	-0.4+6.0% of setting	
		2000 - 4000	-0.6-1.0% of setting	2.0	-0.8+6.5% of setting	
		4000 - 6000	-0.2-5.0% of setting	-1.7	2.0+0.5% of setting	
		6000 - 7200	0.2-6.0% of setting	-3.0	0.9	
		7200 - 8000	-0.7-4.5% of setting	-2.7	0.2+2.0% of setting	
	80.25 - 90 dB	1 - 2000	-0.4-0.5% of setting	3.7	-3.6+10.0% of setting	
		2000 - 4000	-0.6-1.0% of setting	2.8	-3.0+9.0% of setting	
		4000 - 6000	3.0-9.0% of setting	-2.3	2.0+0.5% of setting	
		6000 - 7200	3.6-10.0% of setting	-3.7	0.9	
		7200 - 8000	-0.7-4.5% of setting	-2.9	-1.7+6.0% of setting	
90.25 - 95 dB	1 - 2000	-0.4-0.5% of setting	3.7	-3.6+10.0% of setting		
	2000 - 4000	-0.6-1.0% of setting	2.8	-3.0+9.0% of setting		
	4000 - 6000	3.0-9.0% of setting	-2.3	2.0+0.5% of setting		
	6000 - 7200	3.6-10.0% of setting	-3.7	0.9		
	7200 - 8000	-0.7-4.5% of setting	-2.9	-1.7+6.0% of setting		
Insertion Loss	0 dB	1 - 2000	-	4.2	6.0	dB
		2000 - 4000	-	5.6	8.0	
		4000 - 6000	-	7.4	9.0	
		6000 - 7200	-	8.3	11.5	
		7200 - 8000	-	10.0	12.0	
Isolation	In-Out (within a channel) ³	1 - 8000	-	100	-	dB
	Between channels ⁴	1 - 8000	100	125	-	

- Attenuator RF ports support simultaneous, bi-directional signal transmission, within the specified power limits. However the specifications are guaranteed for the RF In and RF Out as noted on the label. There may be minor changes in performance when injecting signals to the RF Out port.
- Max accuracy defined as $\pm[\text{absolute error} + \% \text{ of attenuation setting}]$. For example, if a 20 dB attenuation at a given frequency is defined as max accuracy of “ $\pm(0.5 + 3.0\%)$ ” then the maximum error at those settings will be: $\pm(0.5 + 0.03 \times 20) = \pm(0.5 + 0.6) = \pm 1.1$ dB.
- Isolation within a channel is defined as max attenuation plus insertion loss; this is the path loss through the attenuator when initially powered up. After a brief delay (~0.5 sec typically) the attenuator will revert to a user defined “power-up” state (either max attenuation or a pre-set value).
- Isolation between channels may drop to 95 dB when both channels being tested are at 0 dB attenuation state.



ELECTRICAL SPECIFICATIONS¹, 25°C (CONTINUED)

Parameter	Conditions	Frequency (MHz)	Min.	Typ.	Max.	Unit
Return Loss	0 - 95 dB	1 - 2000	-	23	-	dB
		2000 - 4000	-	21	-	
		4000 - 6000	-	19	-	
		6000 - 7200	-	14	-	
	0 - 90 dB	7200 - 8000	-	11	-	
IP3 Input ⁵	0 dB setting (P _{IN} = +5 dBm)	1 - 5000	-	+53	-	dBm
		5000 - 8000	-	+48	-	
Attenuation Transition Time ⁶	-	1 - 8000	-	650	-	ns
Minimum Dwell Time ⁷	High-speed mode	1 - 8000	-	600	-	μs
Channel Synchronization ⁸	-	1 - 8000	-	400	-	μs
Supply Voltage (V _{DC}) ⁹	USB port	-	4.75	5.00	5.25	V
Supply Current (I _{DC})		-	-	210	330	mA
Supply Voltage (V _{DC}) ⁹	LAN port ¹⁰	-	37	48	57	V
Supply Current (I _{DC})		-	-	40	50	mA
Operating RF Input Power ^{1, 11}	0 - 95 dB	1 - 50	-	-	Note 12	dBm
		50 - 8000	-	-	+28	

5. Tested with 1 MHz span between signals.

6. Attenuation Transition Time is specified as the time between starting to change the attenuation state and settling on the requested attenuation state.

7. Minimum Dwell Time is the minimum time from settling on one attenuation level to settling to a new one in response to command (without communication protocol delays).

8. Channel Synchronization is the delay between the first and last attenuator transitions beginning, in response to a command to set all channels.

9. Power supply can be provided from either USB or LAN port regardless of control method used.

10. Compliant with IEEE 802.3af mode A and mode B.

11. Total Operating Input Power from both RF In and RF Out ports. Compression level not noted as it exceeds max safe operating power level.

12. Derates linearly from +28 dBm at 50 MHz to +17 dBm at 1 MHz.

ABSOLUTE MAXIMUM RATINGS ^{13, 14}

Operating Temperature		0°C to +50°C
Storage Temperature		-20°C to +85°C
DC Voltage @ RF Ports		16 V
V _{USB} MAX		6 V
V _{LAN} MAX		57 V
Max RF Power	1 - 50 MHz	Derates linearly from +33 dBm at 50 MHz to +20 dBm at 1 MHz
	50 - 8000 MHz	+33 dBm

13. Permanent damage may occur if any of these limits are exceeded.

14. Operating in the range between operating power limits and absolute maximum ratings for extended periods of time may result in reduced life and reliability.



TYPICAL PERFORMANCE GRAPHS

Attenuation Accuracy @ 0°C vs. Frequency over Attenuation settings

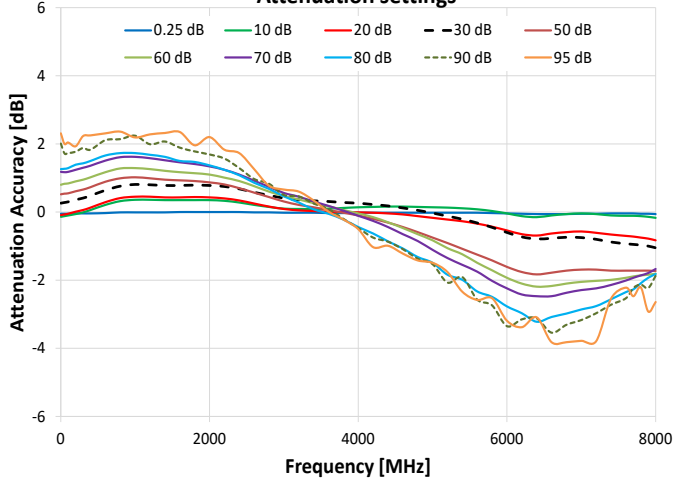

Attenuation Accuracy @ 30 dB vs. Frequency at all Channels

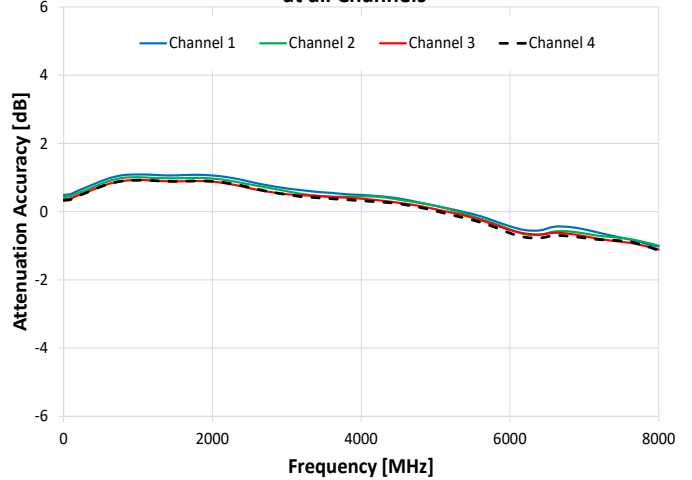

Attenuation Accuracy @ 25°C vs. Frequency over Attenuation settings

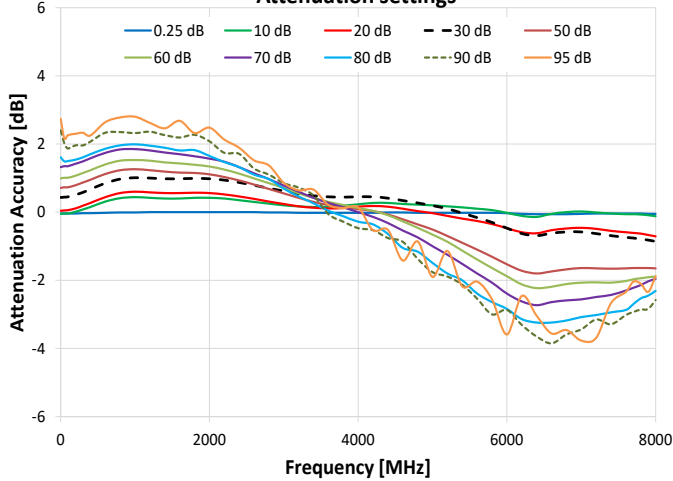

Attenuation Accuracy @ 60 dB vs. Frequency at all Channels

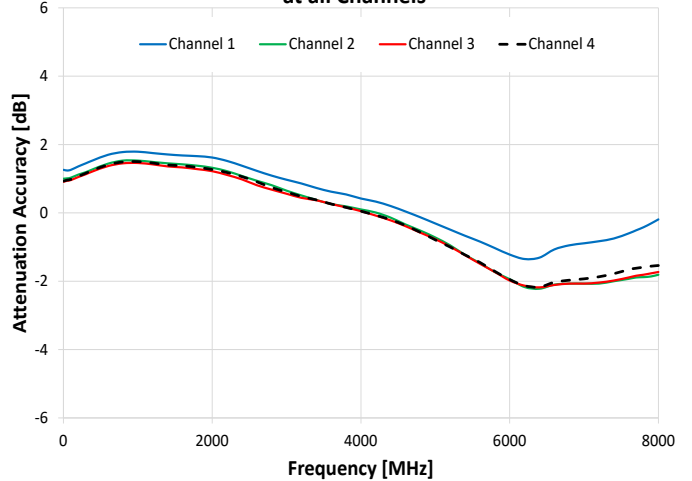

Attenuation Accuracy @ 50°C vs. Frequency over Attenuation settings

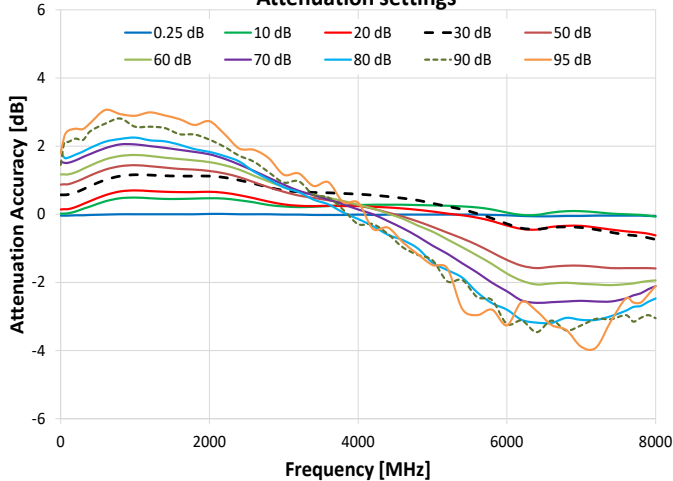

Attenuation Accuracy @ 90 dB vs. Frequency at all Channels

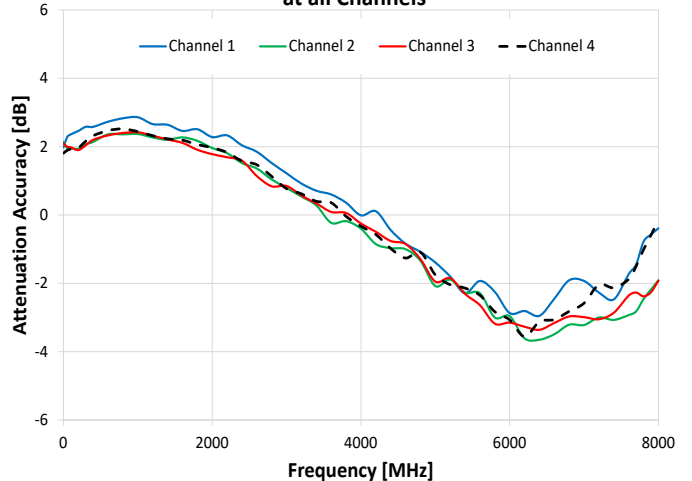



TYPICAL PERFORMANCE GRAPHS (CONTINUED)

Attenuation relative to Insertion Loss vs. Frequency (at 2 dB steps)

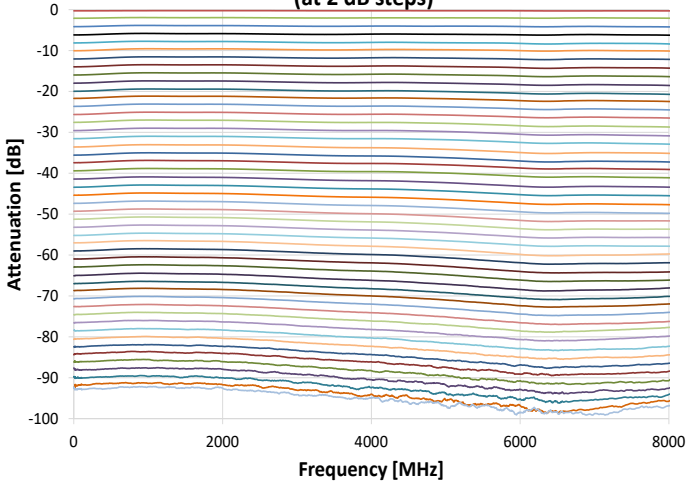

Insertion Loss vs. Frequency over Temperature

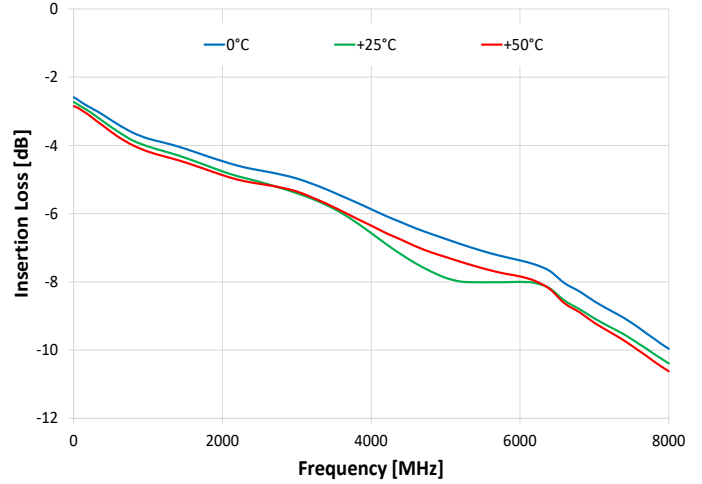

Return Loss In vs. Frequency over Attenuation settings

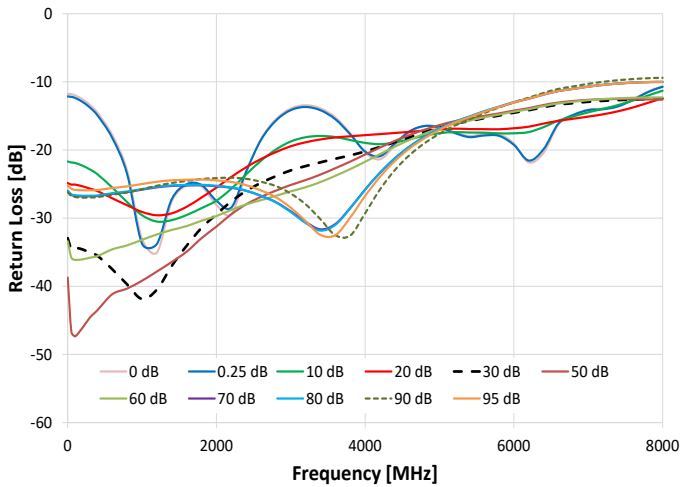

Return Loss Out vs. Frequency over Attenuation settings

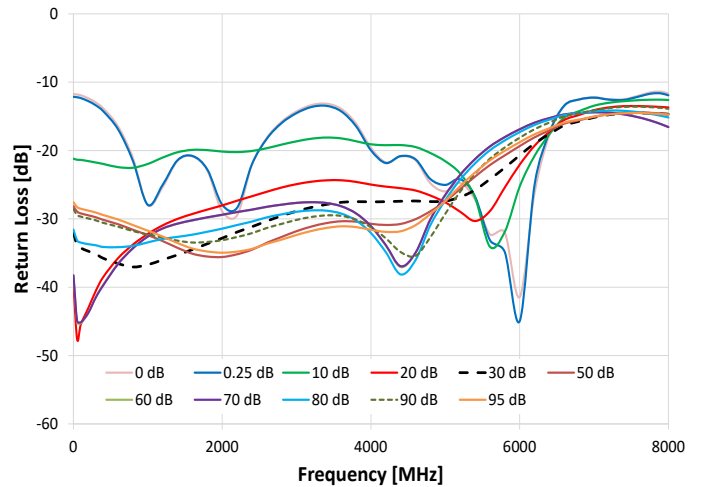

Isolation between Channels vs. Frequency over Attenuation settings

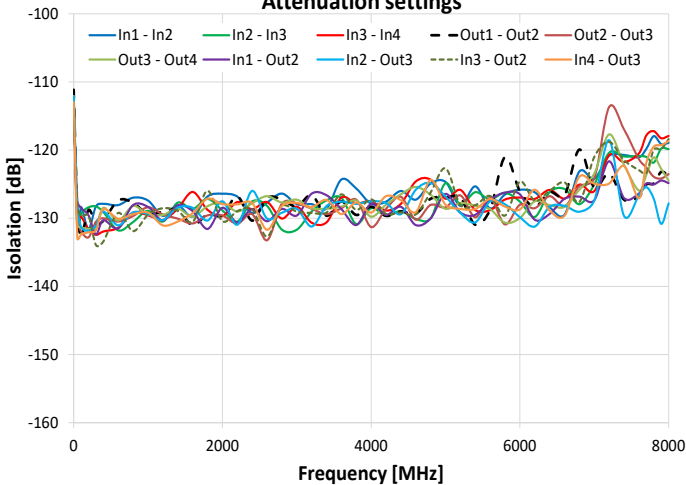

IP3 @ 0 dB Attenuation vs. Frequency over Temperature

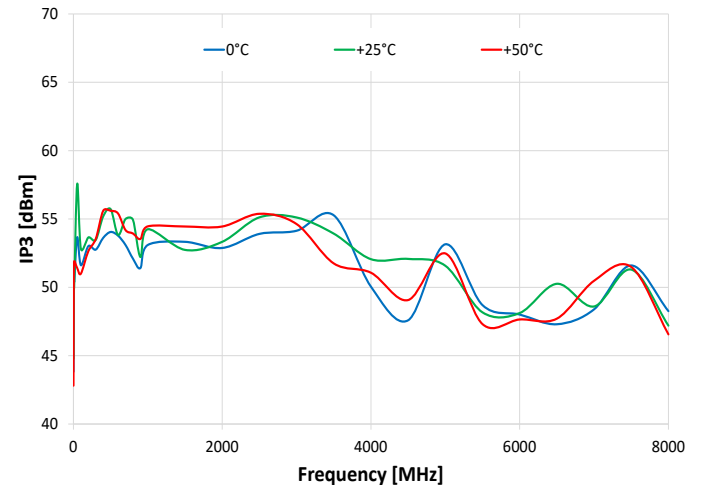



Programmable Attenuator **RC4DAT-8G-95PE**

CONTROL INTERFACES

Ethernet Control	Supported Protocols	TCP / IP, HTTP, Telnet, SSH, DHCP, UDP (limited)
	Max Data Rate	100 Mbps (100 Base-T Full Duplex)
USB Control	Protocol	HID (Human Interface Device) - High-speed
	Min Communication Time ¹⁵	400 μsec typical (full transmit/receive cycle)

15. USB Min Communication Time is based on the polling interval of the USB HID protocol (125 μsec polling interval, 64 bytes per packet), medium CPU load and no other high-speed USB devices using the USB bus.

SOFTWARE & DOCUMENTATION

Mini-Circuits' full software and support package including user guide, Windows GUI, API, programming manual and examples can be downloaded free of charge (refer to the last page for the download path).

A comprehensive set of software control options is provided:

- GUI for Windows – Simple software interface for control via Ethernet and USB.
- Programming / automation via Ethernet:
 - Complete set of control commands which can be sent via any supported protocol.
 - Simple to implement in the majority of modern programming environments.
- Programming / automation via USB:
 - DLL files provide a full API for Windows with a set of intuitive functions which can be implemented in any programming environment supporting .Net Framework or ActiveX.
 - Direct USB programming is possible in any other environment (not supporting .Net or ActiveX).

Please contact testsolutions@minicircuits.com for support.

MINIMUM SYSTEM REQUIREMENTS

GUI	Windows 7 or later
USB API DLL	Windows 7 or later and programming environment with ActiveX or .NET support
USB Direct Programming	Linux, Windows 7 or later
Hardware	Intel i3 (or equivalent) or later



GRAPHICAL USER INTERFACE (GUI) FOR WINDOWS - KEY FEATURES

- Connect via USB or Ethernet to control the module.
- Password protected access for safe remote usage over Ethernet.

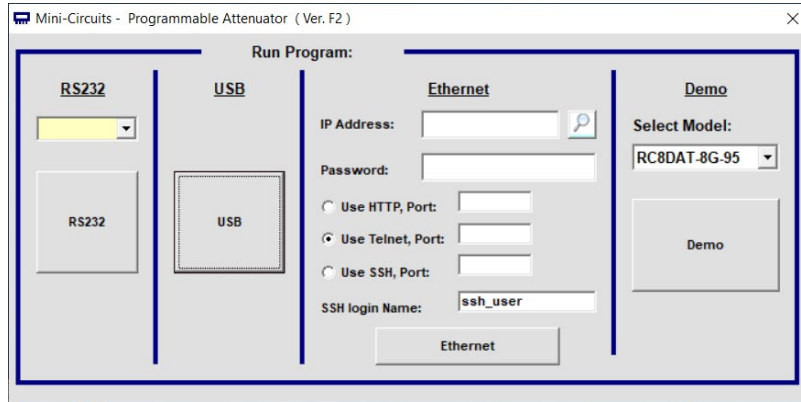

- Run GUI in "demo mode" to evaluate software without a hardware connection.
- Manual attenuation setting.
- Sweep and Hop attenuation sequences directed from the PC, or entire sequence loaded into the module.
- Attenuator address configuration and firmware upgrade.
- Attenuation at power up may be set to selected attenuation level or last attenuation state recorded.

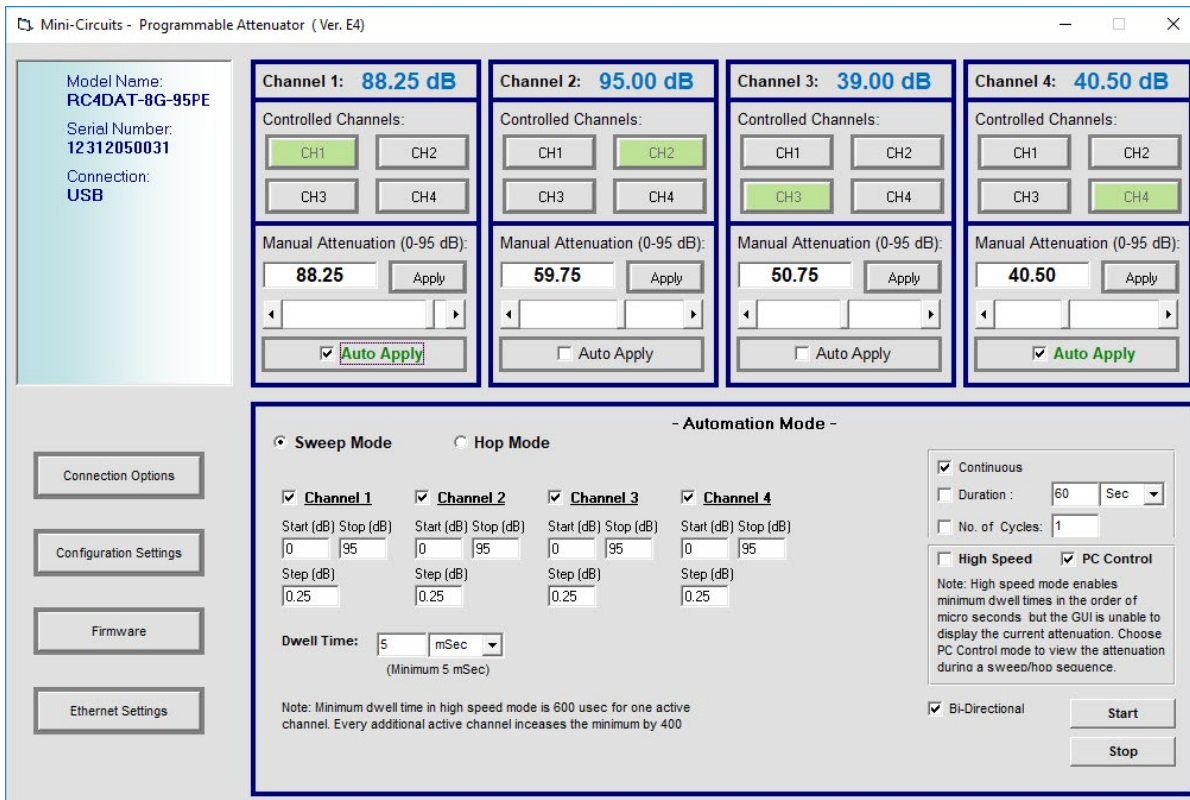



PROGRAMMABLE ATTENUATOR RESPONSE TO COMMUNICATION INTERRUPT

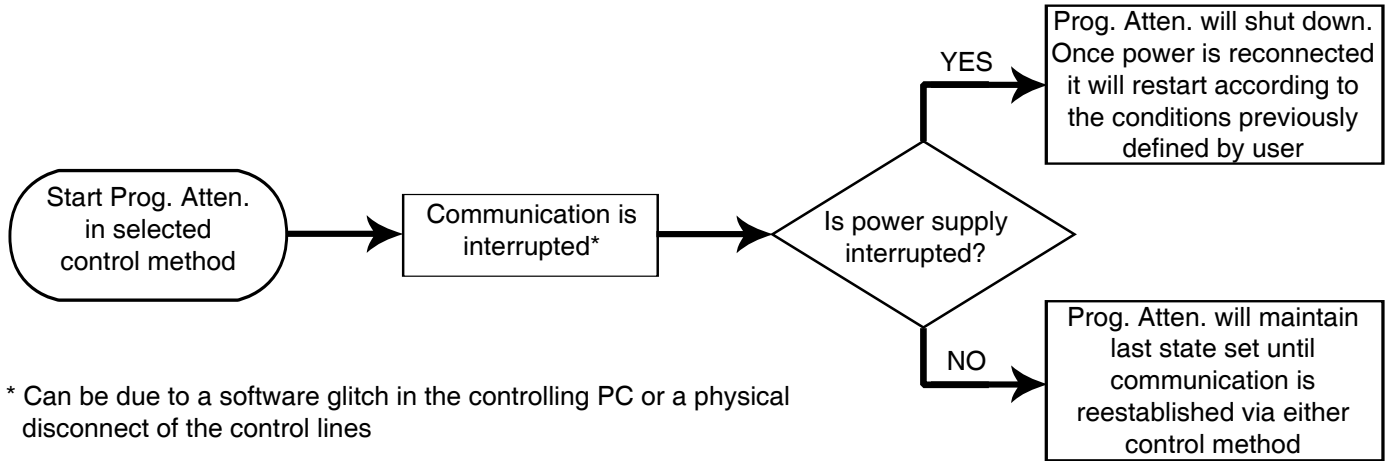

BLOCK DIAGRAM

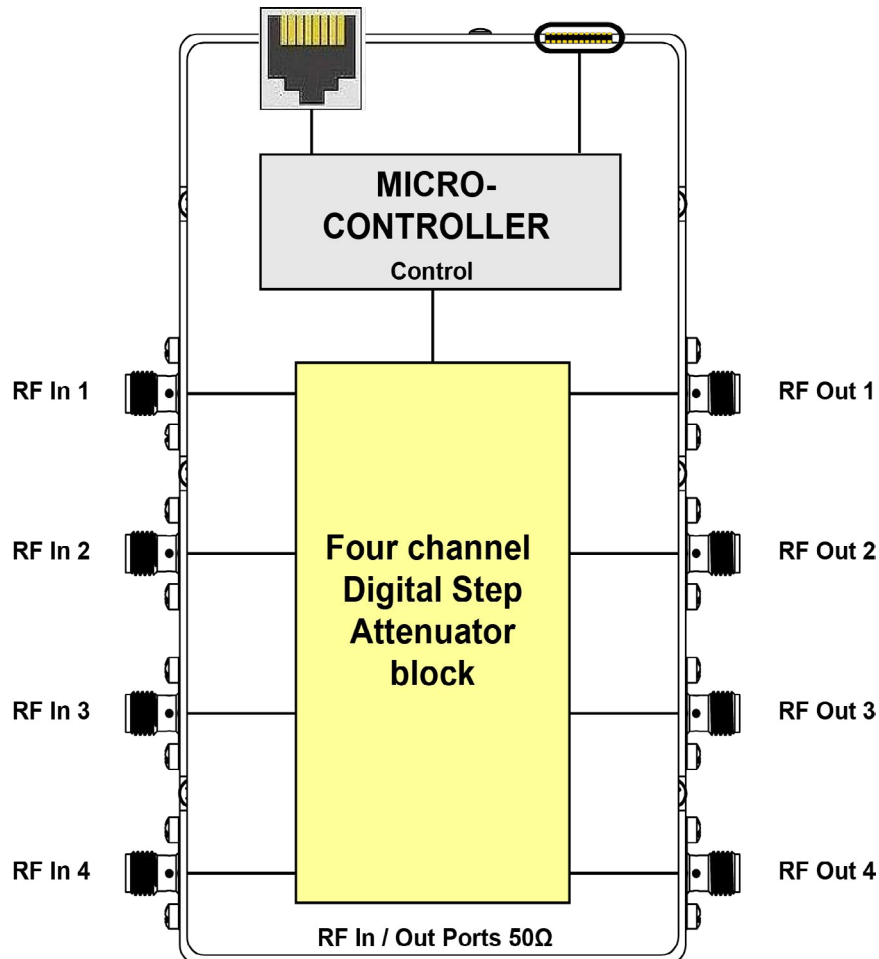

Simultaneous, bidirectional RF signal transmission with symmetrical performance



CASE STYLE DRAWING (QE2972)

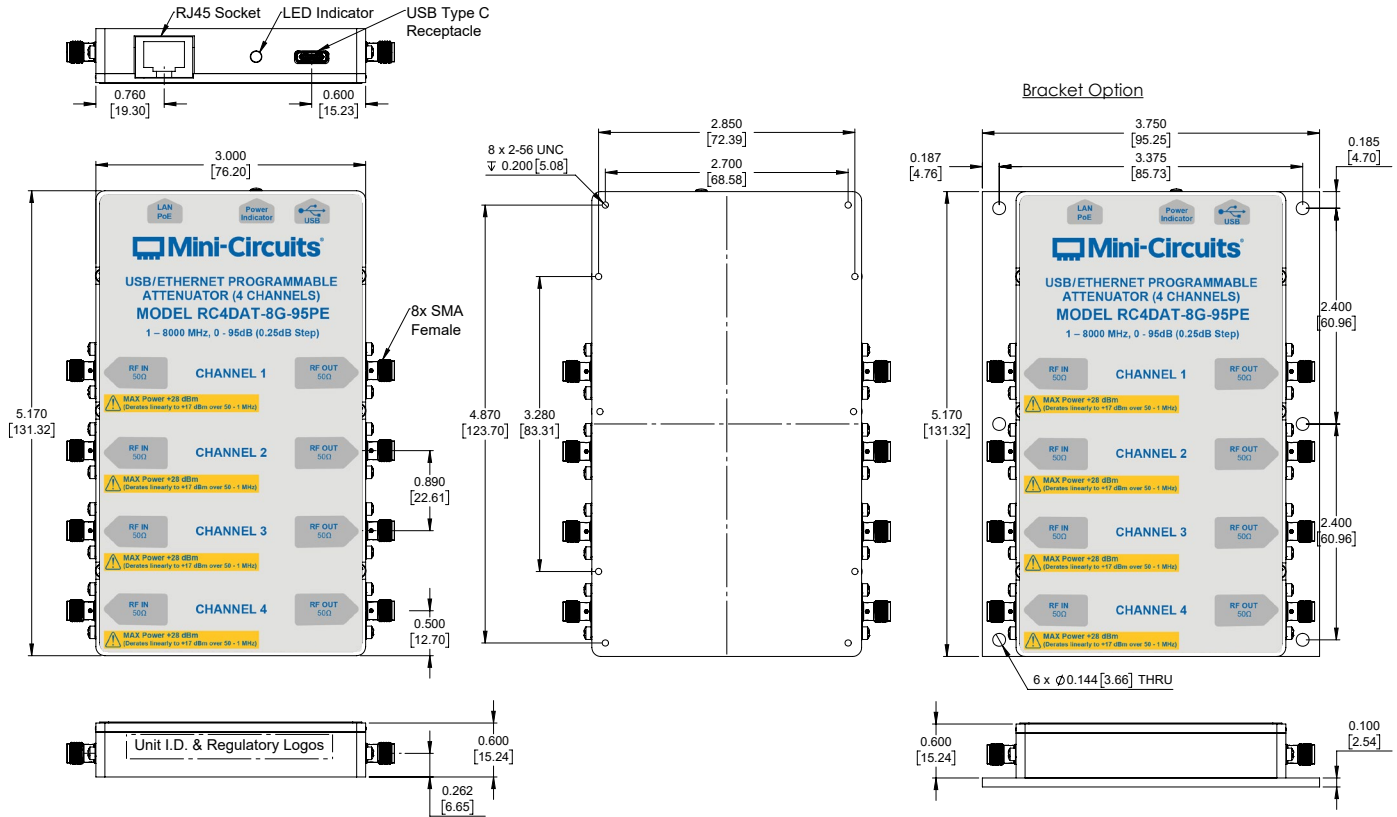

NOTES:

1. Case material: Aluminum alloy.
2. Case Finish: Nickel Plate.
3. Weight: 300 grams
4. Marking may contain other features or characters for internal lot control.

Instruction for mounting bracket:

1. Tool required: Phillips head screwdriver.
2. Mount the bracket over threaded holes on the bottom side with the fasteners provided with the bracket.

CONNECTIONS

Port Name	Connector Type	Function
RF In (50Ω) & RF Out (50Ω)	SMA female	RF input / output port
USB	USB Type C female	USB control & DC power
Ethernet	RJ45 Socket	LAN control & DC power

CONNECTION DIAGRAMS ETHERNET POWER & CONTROL

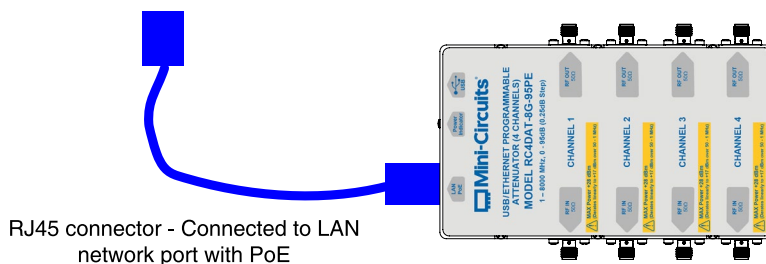



CONNECTION DIAGRAMS (CONTINUE)

USB CONTROL

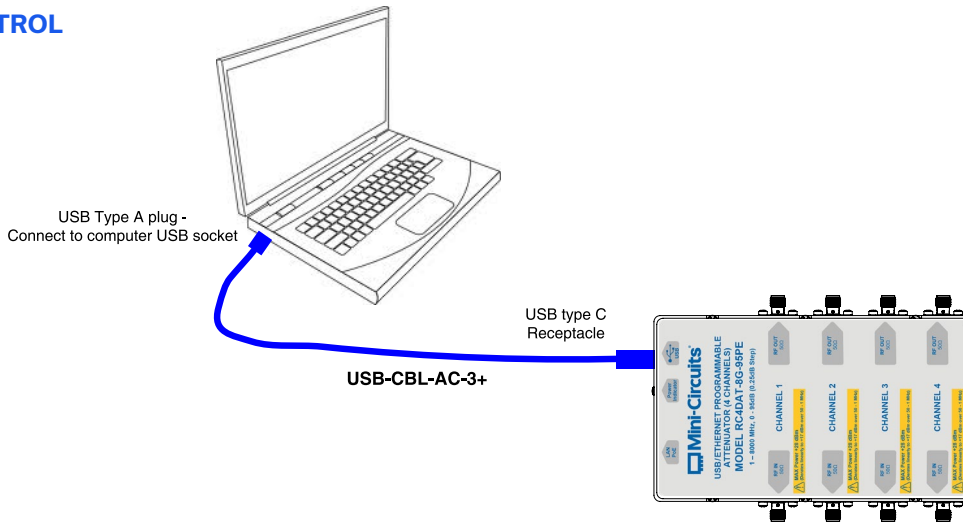

ETHERNET CONTROL & USB POWER (USING POWER ADAPTER)

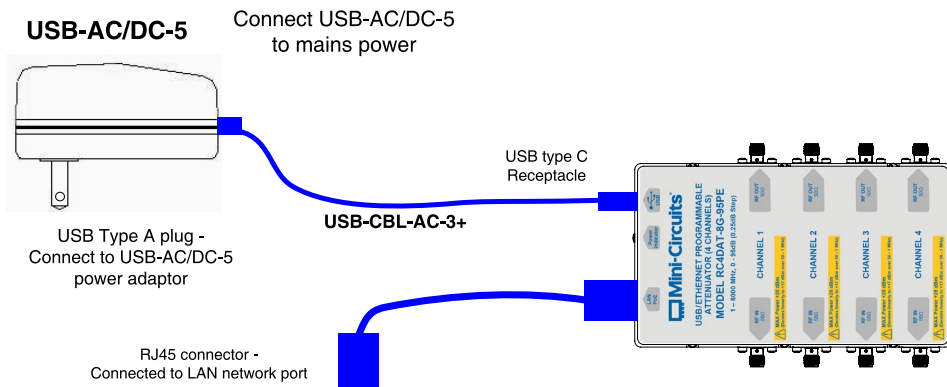

ETHERNET POWER & USB CONTROL

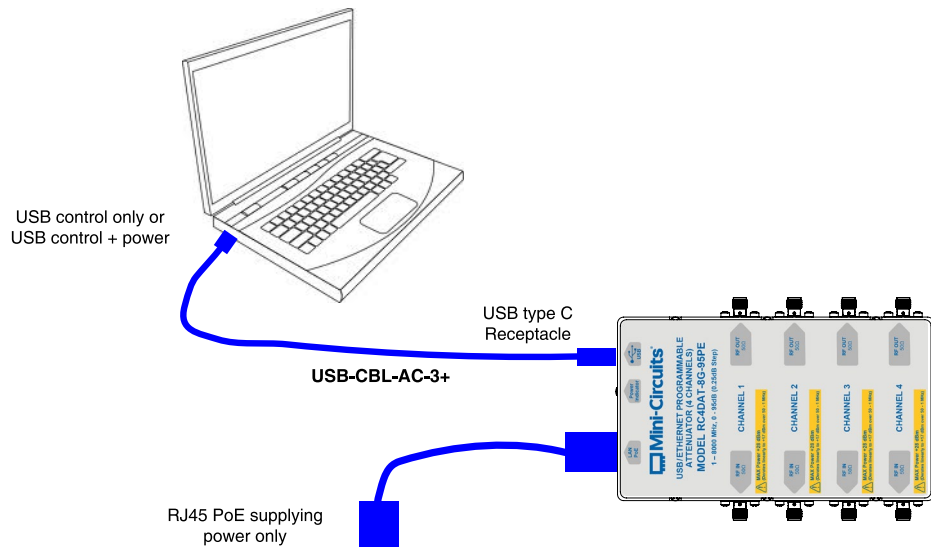



USB & ETHERNET

Programmable Attenuator

RC4DAT-8G-95PE



50Ω 1 to 8000 MHz 0 to 95 dB 0.25 dB Step SMA Female

DETAILED MODEL INFORMATION IS AVAILABLE ON OUR WEBSITE [CLICK HERE](#)



Performance Data & Graphs	Data Graphs
Case Style	QE2972
Environmental Rating	ENV55T1
Software, User Guide & Programming Manual	https://www.minicircuits.com/softwaredownload/patt.html
Regulatory Compliance	<p>Refer to user guide for compliance information</p>  <p>https://www.minicircuits.com/app/AN49-011.pdf</p>
Support	testsolutions@minicircuits.com

INCLUDED ACCESSORIES ¹⁶

	Part No.	Qty.	Description
	USB-CBL-AC-3+	1	3.3 ft (1.0 m) USB cable: USB type A (Male) to USB type C (Male)

16. Additional quantities are available for purchase as optional accessories.

OPTIONAL ACCESSORIES

	Part No.	Description
	CBL-RJ45-MM-5+	5.0 ft (1.5 m) Ethernet cable: RJ45 (Male) to RJ45 (Male) Cat 5E cable
	USB-AC/DC-5+	AC/DC +5V power adaptor with USB connector ^{17, 18}
(N/A)	BKT-355-02+	Bracket kit including 3.75" x 5.17" bracket, mounting screws and washers
	RKT-RC4DAT-2	Rack-mounting bracket (19" width, 1U height) for up to 2 x RC4DAT-8G-95, including all required accessories for mounting within a rack cabinet.

17. The power adaptor may be used to provide additional power via USB port when connecting several units in daisy chain control.

18. Includes power plugs for US, UK, EU, IL, AU & China. Plugs for other countries are also available. If you need a power cord for a country not listed, please contact testsolutions@minicircuits.com

NOTES:

- Performance and quality attributes and conditions not expressly stated in this specification document are intended to be excluded and do not form a part of this specification document.
- Electrical specifications and performance data contained in this specification document are based on Mini-Circuit's applicable established test performance criteria and measurement instructions.
- The parts covered by this specification document are subject to Mini-Circuits standard limited warranty and terms and conditions (collectively, "Standard Terms"); Purchasers of this part are entitled to the rights and benefits contained therein. For a full statement of the Standard Terms and the exclusive rights and remedies thereunder, please visit Mini-Circuits' website at <https://www.minicircuits.com/terms/viewterm.html>



Programmable Attenuator

RC4DAT-8G-95PE

Typical Performance Data

Test Conditions: @ Temperature = 0°C.

Freq. (MHz)	Attenuation relative to Insertion Loss (dB)									
	0.25 dB	10 dB	20 dB	30 dB	50 dB	60 dB	70 dB	80 dB	90 dB	95 dB
1	-0.30	-10.14	-20.09	-29.74	-49.48	-59.20	-68.82	-78.74	-87.99	-92.69
50	-0.30	-10.12	-20.07	-29.72	-49.46	-59.17	-68.83	-78.73	-88.28	-93.00
100	-0.30	-10.10	-20.05	-29.70	-49.45	-59.16	-68.82	-78.71	-88.27	-92.96
200	-0.29	-10.06	-19.99	-29.64	-49.39	-59.10	-68.76	-78.61	-88.23	-93.07
300	-0.29	-10.01	-19.94	-29.59	-49.34	-59.05	-68.70	-78.57	-88.12	-92.77
400	-0.29	-9.94	-19.87	-29.52	-49.27	-58.98	-68.64	-78.50	-88.17	-92.75
600	-0.28	-9.79	-19.71	-29.36	-49.11	-58.83	-68.49	-78.34	-87.89	-92.69
800	-0.26	-9.68	-19.59	-29.24	-49.01	-58.72	-68.39	-78.27	-87.86	-92.64
1000	-0.26	-9.64	-19.55	-29.19	-48.98	-58.71	-68.38	-78.27	-87.76	-92.81
1200	-0.26	-9.64	-19.55	-29.20	-49.01	-58.74	-68.42	-78.32	-88.01	-92.72
1400	-0.26	-9.65	-19.57	-29.22	-49.05	-58.79	-68.48	-78.38	-87.93	-92.68
1600	-0.25	-9.65	-19.57	-29.22	-49.07	-58.83	-68.54	-78.50	-88.11	-92.65
1800	-0.25	-9.65	-19.56	-29.21	-49.09	-58.86	-68.59	-78.53	-88.22	-93.04
2000	-0.25	-9.65	-19.57	-29.22	-49.13	-58.90	-68.66	-78.63	-88.31	-92.80
2200	-0.25	-9.67	-19.60	-29.25	-49.19	-58.99	-68.76	-78.76	-88.43	-93.17
2400	-0.25	-9.72	-19.66	-29.32	-49.30	-59.09	-68.90	-78.92	-88.71	-93.27
2600	-0.26	-9.79	-19.75	-29.42	-49.43	-59.24	-69.08	-79.14	-89.03	-93.74
2800	-0.26	-9.85	-19.84	-29.51	-49.56	-59.40	-69.26	-79.32	-89.17	-94.23
3000	-0.27	-9.90	-19.91	-29.59	-49.69	-59.53	-69.44	-79.54	-89.50	-94.34
3200	-0.27	-9.91	-19.95	-29.64	-49.79	-59.63	-69.55	-79.72	-89.54	-94.40
3400	-0.27	-9.91	-19.97	-29.67	-49.86	-59.74	-69.69	-79.92	-89.75	-94.66
3600	-0.28	-9.90	-19.99	-29.69	-49.94	-59.83	-69.82	-80.05	-89.91	-94.99
3800	-0.28	-9.88	-20.00	-29.72	-50.02	-59.94	-69.96	-80.22	-90.20	-95.22
4000	-0.27	-9.86	-20.01	-29.74	-50.10	-60.04	-70.11	-80.44	-90.47	-95.50
4200	-0.27	-9.85	-20.02	-29.78	-50.20	-60.15	-70.26	-80.63	-90.75	-96.03
4400	-0.27	-9.84	-20.04	-29.82	-50.31	-60.30	-70.44	-80.86	-90.87	-95.99
4600	-0.27	-9.84	-20.07	-29.88	-50.44	-60.47	-70.65	-81.07	-91.09	-96.22
4800	-0.27	-9.85	-20.12	-29.95	-50.59	-60.65	-70.85	-81.32	-91.37	-96.42
5000	-0.27	-9.86	-20.17	-30.03	-50.75	-60.83	-71.11	-81.49	-91.53	-96.49
5200	-0.27	-9.87	-20.22	-30.12	-50.91	-61.06	-71.35	-81.84	-92.07	-96.76
5400	-0.27	-9.89	-20.27	-30.21	-51.08	-61.24	-71.55	-81.99	-91.91	-97.34
5600	-0.27	-9.92	-20.34	-30.32	-51.25	-61.49	-71.75	-82.33	-92.57	-97.58
5800	-0.28	-9.97	-20.43	-30.45	-51.42	-61.71	-72.02	-82.49	-92.74	-97.53
6000	-0.29	-10.04	-20.54	-30.60	-51.61	-61.93	-72.24	-82.77	-93.35	-98.19
6200	-0.30	-10.12	-20.65	-30.73	-51.76	-62.10	-72.42	-82.97	-93.15	-98.38
6400	-0.31	-10.15	-20.69	-30.79	-51.83	-62.19	-72.47	-83.22	-93.12	-98.09
6600	-0.31	-10.10	-20.63	-30.77	-51.78	-62.17	-72.47	-83.08	-93.54	-98.82
6800	-0.31	-10.06	-20.59	-30.74	-51.72	-62.10	-72.37	-82.98	-93.31	-98.82
7000	-0.30	-10.04	-20.57	-30.75	-51.69	-62.05	-72.29	-82.86	-93.17	-98.78
7200	-0.30	-10.06	-20.61	-30.80	-51.69	-62.02	-72.24	-82.76	-92.97	-98.79
7400	-0.29	-10.10	-20.66	-30.88	-51.72	-61.99	-72.14	-82.56	-92.72	-97.54
7600	-0.29	-10.11	-20.70	-30.93	-51.72	-61.93	-72.01	-82.35	-92.53	-97.22
7700	-0.29	-10.11	-20.72	-30.95	-51.72	-61.89	-71.93	-82.27	-92.23	-97.47
7800	-0.30	-10.12	-20.75	-30.97	-51.72	-61.86	-71.86	-82.09	-92.13	-97.21
7900	-0.30	-10.14	-20.78	-31.00	-51.72	-61.84	-71.79	-81.93	-92.23	-97.92
8000	-0.31	-10.17	-20.83	-31.05	-51.73	-61.81	-71.67	-81.82	-91.87	-97.64

Programmable Attenuator

RC4DAT-8G-95PE

Typical Performance Data

Test Conditions: @ Temperature = 0°C.

Freq. (MHz)	Attenuation accuracy relative to nominal attenuation setting (dB)									
	0.25 dB	10 dB	20 dB	30 dB	50 dB	60 dB	70 dB	80 dB	90 dB	95 dB
1	-0.05	-0.14	-0.09	0.26	0.52	0.80	1.18	1.26	2.01	2.31
50	-0.05	-0.12	-0.07	0.28	0.54	0.83	1.17	1.27	1.72	2.00
100	-0.05	-0.10	-0.05	0.30	0.55	0.84	1.18	1.29	1.73	2.04
200	-0.04	-0.06	0.01	0.36	0.61	0.90	1.24	1.39	1.77	1.93
300	-0.04	-0.01	0.06	0.41	0.66	0.95	1.30	1.43	1.88	2.23
400	-0.04	0.06	0.13	0.48	0.73	1.02	1.36	1.50	1.83	2.25
600	-0.03	0.21	0.29	0.64	0.89	1.17	1.51	1.66	2.11	2.31
800	-0.01	0.32	0.41	0.76	0.99	1.28	1.61	1.73	2.14	2.36
1000	-0.01	0.36	0.45	0.81	1.02	1.29	1.62	1.73	2.24	2.19
1200	-0.01	0.36	0.45	0.80	0.99	1.26	1.58	1.68	1.99	2.28
1400	-0.01	0.35	0.43	0.78	0.95	1.21	1.52	1.62	2.07	2.32
1600	0.00	0.35	0.43	0.78	0.93	1.17	1.46	1.50	1.89	2.35
1800	0.00	0.35	0.44	0.79	0.91	1.14	1.41	1.47	1.78	1.96
2000	0.00	0.35	0.43	0.78	0.87	1.10	1.34	1.37	1.69	2.20
2200	0.00	0.33	0.40	0.75	0.81	1.01	1.24	1.24	1.57	1.83
2400	0.00	0.28	0.34	0.68	0.70	0.91	1.10	1.08	1.29	1.73
2600	-0.01	0.21	0.25	0.58	0.57	0.76	0.92	0.86	0.97	1.26
2800	-0.01	0.15	0.16	0.49	0.44	0.60	0.74	0.68	0.83	0.77
3000	-0.02	0.10	0.09	0.41	0.31	0.47	0.56	0.46	0.50	0.66
3200	-0.02	0.09	0.05	0.36	0.21	0.37	0.45	0.28	0.46	0.60
3400	-0.02	0.09	0.03	0.33	0.14	0.26	0.31	0.08	0.25	0.34
3600	-0.03	0.10	0.01	0.31	0.06	0.17	0.18	-0.05	0.09	0.01
3800	-0.03	0.12	0.00	0.28	-0.02	0.06	0.04	-0.22	-0.20	-0.22
4000	-0.02	0.14	-0.01	0.26	-0.10	-0.04	-0.11	-0.44	-0.47	-0.50
4200	-0.02	0.15	-0.02	0.22	-0.20	-0.15	-0.26	-0.63	-0.75	-1.03
4400	-0.02	0.16	-0.04	0.18	-0.31	-0.30	-0.44	-0.86	-0.87	-0.99
4600	-0.02	0.16	-0.07	0.12	-0.44	-0.47	-0.65	-1.07	-1.09	-1.22
4800	-0.02	0.15	-0.12	0.05	-0.59	-0.65	-0.85	-1.32	-1.37	-1.42
5000	-0.02	0.14	-0.17	-0.03	-0.75	-0.83	-1.11	-1.49	-1.53	-1.49
5200	-0.02	0.13	-0.22	-0.12	-0.91	-1.06	-1.35	-1.84	-2.07	-1.76
5400	-0.02	0.11	-0.27	-0.21	-1.08	-1.24	-1.55	-1.99	-1.91	-2.34
5600	-0.02	0.08	-0.34	-0.32	-1.25	-1.49	-1.75	-2.33	-2.57	-2.58
5800	-0.03	0.03	-0.43	-0.45	-1.42	-1.71	-2.02	-2.49	-2.74	-2.53
6000	-0.04	-0.04	-0.54	-0.60	-1.61	-1.93	-2.24	-2.77	-3.35	-3.19
6200	-0.05	-0.12	-0.65	-0.73	-1.76	-2.10	-2.42	-2.97	-3.15	-3.38
6400	-0.06	-0.15	-0.69	-0.79	-1.83	-2.19	-2.47	-3.22	-3.12	-3.09
6600	-0.06	-0.10	-0.63	-0.77	-1.78	-2.17	-2.47	-3.08	-3.54	-3.82
6800	-0.06	-0.06	-0.59	-0.74	-1.72	-2.10	-2.37	-2.98	-3.31	-3.82
7000	-0.05	-0.04	-0.57	-0.75	-1.69	-2.05	-2.29	-2.86	-3.17	-3.78
7200	-0.05	-0.06	-0.61	-0.80	-1.69	-2.02	-2.24	-2.76	-2.97	-3.79
7400	-0.04	-0.10	-0.66	-0.88	-1.72	-1.99	-2.14	-2.56	-2.72	-2.54
7600	-0.04	-0.11	-0.70	-0.93	-1.72	-1.93	-2.01	-2.35	-2.53	-2.22
7700	-0.04	-0.11	-0.72	-0.95	-1.72	-1.89	-1.93	-2.27	-2.23	-2.47
7800	-0.05	-0.12	-0.75	-0.97	-1.72	-1.86	-1.86	-2.09	-2.13	-2.21
7900	-0.05	-0.14	-0.78	-1.00	-1.72	-1.84	-1.79	-1.93	-2.23	-2.92
8000	-0.06	-0.17	-0.83	-1.05	-1.73	-1.81	-1.67	-1.82	-1.87	-2.64

Programmable Attenuator

RC4DAT-8G-95PE

Typical Performance Data

Test Conditions: @ Temperature = 0°C.

Freq. (MHz)	Return Loss In (dB)									
	0.25 dB	10 dB	20 dB	30 dB	50 dB	60 dB	70 dB	80 dB	90 dB	95 dB
1	-12.59	-24.38	-29.30	-37.88	-29.75	-27.34	-22.69	-22.63	-22.80	-22.18
50	-12.66	-24.46	-29.66	-45.39	-31.18	-28.24	-23.13	-23.06	-23.24	-22.59
100	-12.76	-24.15	-29.00	-48.56	-32.20	-28.97	-23.53	-23.47	-23.64	-22.96
200	-13.18	-24.09	-28.46	-53.61	-33.48	-29.85	-24.05	-23.97	-24.15	-23.43
300	-13.97	-24.78	-28.85	-46.92	-32.86	-29.52	-23.93	-23.85	-24.03	-23.32
400	-15.16	-25.83	-29.66	-44.66	-31.88	-28.86	-23.59	-23.51	-23.69	-23.02
600	-18.18	-27.18	-30.01	-47.24	-32.10	-28.93	-23.61	-23.53	-23.67	-23.02
800	-23.73	-28.74	-30.21	-46.55	-32.19	-28.95	-23.60	-23.52	-23.63	-23.00
1000	-34.07	-29.23	-30.06	-49.60	-32.77	-29.19	-23.67	-23.58	-23.61	-23.03
1200	-30.79	-28.95	-29.50	-52.76	-33.72	-29.69	-23.86	-23.76	-23.72	-23.19
1400	-25.62	-28.58	-28.98	-52.00	-34.65	-30.17	-24.03	-23.92	-23.79	-23.32
1600	-24.42	-28.30	-28.31	-48.33	-36.17	-30.96	-24.33	-24.21	-23.97	-23.57
1800	-25.92	-28.50	-27.78	-45.91	-37.96	-31.91	-24.67	-24.54	-24.18	-23.86
2000	-29.93	-29.08	-27.58	-45.55	-39.06	-32.54	-24.84	-24.72	-24.26	-24.01
2200	-29.22	-28.98	-27.31	-43.71	-40.36	-33.25	-25.01	-24.90	-24.30	-24.17
2400	-23.43	-28.03	-26.94	-42.26	-41.93	-34.14	-25.22	-25.11	-24.39	-24.36
2600	-19.66	-26.80	-26.69	-41.97	-42.14	-34.52	-25.21	-25.11	-24.28	-24.36
2800	-17.42	-25.30	-26.06	-39.91	-44.29	-35.58	-25.39	-25.31	-24.31	-24.53
3000	-16.22	-24.10	-25.33	-37.83	-47.88	-37.27	-25.67	-25.59	-24.44	-24.78
3200	-15.86	-23.32	-24.66	-36.12	-48.71	-39.37	-25.94	-25.86	-24.55	-25.03
3400	-16.12	-22.77	-23.93	-34.32	-44.61	-42.94	-26.31	-26.23	-24.73	-25.36
3600	-16.96	-22.35	-23.06	-32.14	-38.84	-50.97	-27.04	-26.94	-25.22	-26.01
3800	-18.73	-22.41	-22.41	-30.44	-34.23	-42.24	-27.65	-27.51	-25.74	-26.60
4000	-21.58	-22.74	-21.92	-29.18	-31.42	-36.89	-27.88	-27.72	-26.02	-26.89
4200	-25.00	-23.04	-21.42	-27.81	-29.04	-33.15	-27.98	-27.79	-26.35	-27.14
4400	-25.29	-23.41	-21.16	-26.71	-27.18	-30.34	-27.28	-27.10	-26.17	-26.73
4600	-22.55	-23.60	-21.07	-25.78	-25.78	-28.31	-26.16	-26.01	-25.53	-25.86
4800	-20.57	-23.51	-20.98	-24.63	-24.40	-26.38	-24.88	-24.75	-24.68	-24.79
5000	-20.18	-23.75	-21.18	-23.45	-23.09	-24.54	-23.12	-23.00	-23.17	-23.14
5200	-21.19	-24.25	-21.56	-22.39	-22.00	-23.07	-21.51	-21.41	-21.64	-21.59
5400	-22.62	-24.46	-21.67	-21.04	-20.71	-21.49	-19.92	-19.82	-20.07	-20.01
5600	-23.03	-24.30	-21.56	-19.62	-19.34	-19.90	-18.25	-18.16	-18.36	-18.34
5800	-22.45	-23.69	-21.15	-18.29	-18.04	-18.46	-16.67	-16.59	-16.69	-16.73
6000	-23.18	-22.79	-20.42	-17.14	-16.90	-17.25	-15.35	-15.28	-15.30	-15.41
6200	-27.43	-21.45	-19.39	-16.04	-15.77	-16.10	-14.13	-14.07	-14.01	-14.17
6400	-26.89	-19.84	-18.43	-15.10	-14.80	-15.10	-13.06	-13.01	-12.88	-13.09
6600	-19.14	-17.84	-17.45	-14.21	-13.85	-14.12	-12.00	-11.96	-11.76	-12.03
6800	-16.79	-16.68	-16.87	-13.71	-13.33	-13.56	-11.40	-11.36	-11.12	-11.42
7000	-15.32	-15.58	-16.33	-13.29	-12.89	-13.04	-10.80	-10.77	-10.48	-10.82
7200	-14.93	-14.74	-15.85	-13.02	-12.63	-12.69	-10.36	-10.33	-9.99	-10.37
7400	-14.42	-13.94	-15.26	-12.82	-12.48	-12.44	-10.02	-10.00	-9.62	-10.04
7600	-13.22	-13.03	-14.50	-12.67	-12.41	-12.27	-9.78	-9.76	-9.34	-9.79
7700	-12.49	-12.56	-14.07	-12.61	-12.40	-12.21	-9.70	-9.67	-9.24	-9.70
7800	-11.79	-12.10	-13.63	-12.55	-12.40	-12.16	-9.63	-9.60	-9.15	-9.63
7900	-11.20	-11.64	-13.18	-12.49	-12.40	-12.13	-9.58	-9.56	-9.09	-9.58
8000	-10.74	-11.22	-12.74	-12.43	-12.40	-12.10	-9.56	-9.53	-9.05	-9.55

Programmable Attenuator

RC4DAT-8G-95PE

Typical Performance Data

Test Conditions: @ Temperature = 0°C.

Freq. (MHz)	Return Loss Out (dB)									
	0.25 dB	10 dB	20 dB	30 dB	50 dB	60 dB	70 dB	80 dB	90 dB	95 dB
1	-12.59	-23.72	-32.40	-26.84	-24.35	-29.70	-29.64	-26.37	-24.59	-23.97
50	-12.62	-23.69	-35.25	-27.85	-25.03	-31.32	-31.27	-27.32	-25.30	-24.63
100	-12.67	-23.26	-37.63	-28.87	-25.77	-32.74	-32.67	-28.19	-26.03	-25.31
200	-13.19	-23.34	-39.65	-29.54	-26.22	-33.70	-33.63	-28.74	-26.45	-25.71
300	-13.97	-24.14	-37.28	-28.72	-25.61	-32.20	-32.16	-27.91	-25.84	-25.16
400	-14.74	-24.40	-37.89	-28.91	-25.66	-31.97	-31.95	-27.89	-25.87	-25.21
600	-17.52	-24.69	-40.59	-29.77	-26.06	-32.32	-32.30	-28.23	-26.20	-25.53
800	-21.76	-24.21	-40.34	-30.67	-26.46	-31.88	-31.91	-28.42	-26.52	-25.89
1000	-28.77	-22.98	-38.71	-31.97	-27.15	-32.00	-32.04	-28.94	-27.12	-26.53
1200	-26.41	-21.53	-35.29	-33.14	-27.95	-31.91	-31.96	-29.43	-27.76	-27.23
1400	-22.31	-20.48	-33.23	-34.08	-28.77	-32.07	-32.11	-29.98	-28.45	-27.98
1600	-21.18	-19.86	-31.36	-34.33	-29.59	-31.96	-31.97	-30.36	-29.07	-28.71
1800	-22.59	-19.72	-30.27	-34.56	-30.52	-32.19	-32.19	-30.90	-29.80	-29.56
2000	-27.34	-20.03	-29.77	-34.49	-31.07	-32.32	-32.30	-31.11	-30.16	-30.05
2200	-31.01	-20.37	-29.14	-33.69	-31.23	-31.88	-31.85	-30.86	-30.18	-30.26
2400	-23.49	-20.57	-28.55	-32.76	-31.10	-31.25	-31.22	-30.38	-29.95	-30.24
2600	-18.78	-20.38	-27.69	-31.54	-30.79	-30.34	-30.31	-29.75	-29.60	-30.14
2800	-15.93	-19.87	-26.98	-30.94	-31.05	-29.99	-29.97	-29.69	-29.77	-30.62
3000	-14.44	-19.49	-26.69	-30.73	-31.33	-29.92	-29.92	-29.78	-29.96	-31.09
3200	-13.85	-19.24	-26.63	-30.83	-31.99	-30.24	-30.24	-30.28	-30.51	-31.99
3400	-14.17	-19.32	-27.06	-31.52	-33.24	-31.23	-31.26	-31.34	-31.51	-33.39
3600	-15.26	-19.60	-27.65	-32.35	-35.07	-32.86	-32.90	-32.95	-32.94	-35.41
3800	-17.08	-19.97	-28.40	-33.32	-38.13	-35.79	-35.84	-35.55	-35.18	-38.72
4000	-19.62	-20.27	-29.16	-34.28	-44.53	-41.89	-42.00	-39.49	-38.68	-45.75
4200	-22.15	-20.30	-29.58	-34.63	-52.48	-48.10	-48.15	-41.01	-41.86	-51.13
4400	-23.24	-20.09	-29.51	-34.27	-42.87	-39.01	-39.04	-37.52	-40.31	-41.58
4600	-22.93	-19.89	-29.32	-33.12	-35.86	-32.81	-32.83	-32.98	-35.64	-35.18
4800	-22.87	-20.06	-29.70	-32.26	-31.90	-28.82	-28.84	-29.28	-31.35	-31.18
5000	-23.80	-20.74	-30.64	-30.74	-28.58	-25.63	-25.64	-26.16	-27.80	-27.84
5200	-26.12	-22.13	-33.45	-29.65	-26.36	-23.39	-23.39	-23.88	-25.23	-25.53
5400	-28.37	-24.27	-34.88	-27.53	-24.26	-21.44	-21.44	-21.93	-23.08	-23.47
5600	-29.79	-28.18	-31.12	-25.07	-22.22	-19.64	-19.64	-20.06	-20.98	-21.48
5800	-30.12	-30.93	-26.44	-22.92	-20.64	-18.29	-18.29	-18.66	-19.42	-19.99
6000	-33.33	-26.78	-22.17	-20.53	-18.91	-16.92	-16.92	-17.20	-17.77	-18.39
6200	-25.00	-21.65	-19.25	-18.72	-17.63	-15.97	-15.97	-16.17	-16.56	-17.23
6400	-18.23	-18.33	-17.20	-17.33	-16.62	-15.29	-15.29	-15.39	-15.63	-16.34
6600	-14.13	-15.64	-15.34	-15.91	-15.51	-14.60	-14.60	-14.57	-14.61	-15.34
6800	-12.94	-14.52	-14.50	-15.21	-14.93	-14.31	-14.31	-14.18	-14.08	-14.81
7000	-12.33	-13.56	-13.74	-14.57	-14.38	-14.12	-14.12	-13.85	-13.58	-14.31
7200	-12.43	-13.06	-13.31	-14.17	-14.02	-14.14	-14.15	-13.71	-13.26	-13.99
7400	-12.42	-12.81	-13.13	-13.97	-13.82	-14.36	-14.36	-13.73	-13.09	-13.81
7600	-11.92	-12.62	-13.09	-13.90	-13.75	-14.75	-14.75	-13.89	-13.05	-13.76
7700	-11.61	-12.56	-13.13	-13.92	-13.79	-15.05	-15.05	-14.05	-13.10	-13.80
7800	-11.41	-12.54	-13.20	-13.99	-13.87	-15.42	-15.41	-14.26	-13.20	-13.89
7900	-11.39	-12.53	-13.27	-14.07	-13.98	-15.83	-15.83	-14.50	-13.34	-14.01
8000	-11.63	-12.55	-13.36	-14.17	-14.12	-16.30	-16.30	-14.78	-13.50	-14.17

Programmable Attenuator

RC4DAT-8G-95PE

Typical Performance Data

Test Conditions: @ Temperature = 0°C.

Freq. (MHz)	I. Loss (dB)
1	-2.59
50	-2.65
100	-2.73
200	-2.86
300	-2.98
400	-3.11
600	-3.39
800	-3.63
1000	-3.80
1200	-3.91
1400	-4.03
1600	-4.17
1800	-4.32
2000	-4.46
2200	-4.59
2400	-4.69
2600	-4.77
2800	-4.86
3000	-4.97
3200	-5.12
3400	-5.29
3600	-5.48
3800	-5.67
4000	-5.87
4200	-6.07
4400	-6.25
4600	-6.43
4800	-6.59
5000	-6.74
5200	-6.89
5400	-7.03
5600	-7.16
5800	-7.27
6000	-7.37
6200	-7.49
6400	-7.68
6600	-8.04
6800	-8.28
7000	-8.57
7200	-8.82
7400	-9.06
7600	-9.35
7700	-9.51
7800	-9.66
7900	-9.82
8000	-9.96

Freq. (MHz)	IP3 (dBm)
1	43.83
5	51.26
10	50.38
50	53.66
100	51.62
200	53.01
300	52.76
400	53.62
500	54.05
600	53.78
700	53.10
800	52.10
900	51.41
1000	53.10
1500	53.33
2000	52.88
2500	53.91
3000	54.14
3500	55.27
4000	50.05
4500	47.59
5000	53.15
5500	48.70
6000	48.01
6500	47.30
7000	48.39
7500	51.60
8000	48.26

Programmable Attenuator

RC4DAT-8G-95PE

Typical Performance Data

Test Conditions: @ Temperature = +25°C.

Freq. (MHz)	Attenuation relative to Insertion Loss (dB)									
	0.25 dB	10 dB	20 dB	30 dB	50 dB	60 dB	70 dB	80 dB	90 dB	95 dB
1	-0.29	-10.05	-19.96	-29.57	-49.29	-59.01	-68.68	-78.39	-87.60	-92.26
50	-0.29	-10.04	-19.95	-29.56	-49.27	-58.99	-68.65	-78.51	-87.99	-92.84
100	-0.29	-10.04	-19.94	-29.55	-49.27	-58.99	-68.65	-78.50	-88.13	-92.74
200	-0.29	-9.99	-19.89	-29.49	-49.21	-58.93	-68.58	-78.46	-88.04	-92.70
300	-0.28	-9.92	-19.81	-29.42	-49.13	-58.85	-68.51	-78.39	-88.04	-92.67
400	-0.28	-9.85	-19.73	-29.33	-49.05	-58.77	-68.42	-78.30	-87.93	-92.75
600	-0.27	-9.69	-19.56	-29.15	-48.88	-58.60	-68.26	-78.14	-87.67	-92.36
800	-0.26	-9.59	-19.44	-29.03	-48.77	-58.49	-68.16	-78.04	-87.65	-92.22
1000	-0.26	-9.56	-19.40	-28.99	-48.74	-58.47	-68.15	-78.01	-87.68	-92.20
1200	-0.25	-9.58	-19.42	-29.00	-48.77	-58.49	-68.19	-78.05	-87.64	-92.38
1400	-0.25	-9.60	-19.44	-29.02	-48.81	-58.54	-68.25	-78.11	-87.74	-92.54
1600	-0.25	-9.60	-19.44	-29.02	-48.84	-58.57	-68.30	-78.19	-87.81	-92.32
1800	-0.25	-9.58	-19.43	-29.01	-48.85	-58.61	-68.36	-78.18	-87.73	-92.68
2000	-0.25	-9.58	-19.44	-29.02	-48.89	-58.66	-68.43	-78.35	-87.92	-92.52
2200	-0.25	-9.60	-19.48	-29.06	-48.97	-58.75	-68.52	-78.53	-88.26	-92.87
2400	-0.25	-9.65	-19.54	-29.13	-49.07	-58.87	-68.68	-78.68	-88.29	-93.11
2600	-0.25	-9.70	-19.61	-29.21	-49.19	-59.01	-68.86	-78.90	-88.72	-93.48
2800	-0.26	-9.75	-19.69	-29.30	-49.32	-59.15	-69.03	-79.03	-88.90	-93.63
3000	-0.26	-9.80	-19.76	-29.38	-49.45	-59.29	-69.22	-79.31	-89.15	-94.14
3200	-0.27	-9.83	-19.83	-29.46	-49.58	-59.45	-69.40	-79.54	-89.28	-94.36
3400	-0.27	-9.85	-19.87	-29.52	-49.70	-59.58	-69.58	-79.74	-89.51	-94.34
3600	-0.27	-9.84	-19.89	-29.55	-49.79	-59.70	-69.73	-79.96	-90.06	-94.79
3800	-0.27	-9.81	-19.88	-29.56	-49.86	-59.79	-69.86	-80.12	-90.28	-94.88
4000	-0.27	-9.77	-19.84	-29.55	-49.91	-59.88	-70.00	-80.28	-90.47	-94.86
4200	-0.27	-9.73	-19.82	-29.55	-49.97	-59.96	-70.14	-80.36	-90.53	-95.53
4400	-0.26	-9.73	-19.84	-29.59	-50.07	-60.09	-70.32	-80.64	-90.76	-95.52
4600	-0.26	-9.76	-19.90	-29.66	-50.21	-60.27	-70.54	-81.05	-90.87	-96.42
4800	-0.27	-9.78	-19.97	-29.73	-50.36	-60.46	-70.74	-81.16	-91.37	-95.86
5000	-0.27	-9.80	-20.03	-29.81	-50.51	-60.66	-71.00	-81.49	-91.76	-96.90
5200	-0.27	-9.83	-20.11	-29.90	-50.70	-60.87	-71.25	-81.80	-91.89	-96.14
5400	-0.27	-9.86	-20.19	-30.03	-50.90	-61.13	-71.52	-82.00	-92.13	-97.18
5600	-0.27	-9.90	-20.26	-30.16	-51.10	-61.39	-71.80	-82.39	-92.54	-97.04
5800	-0.27	-9.94	-20.35	-30.30	-51.31	-61.64	-72.07	-82.64	-93.00	-97.56
6000	-0.28	-10.02	-20.47	-30.47	-51.53	-61.88	-72.39	-82.84	-92.87	-98.59
6200	-0.30	-10.11	-20.59	-30.63	-51.72	-62.12	-72.62	-83.14	-93.31	-97.46
6400	-0.31	-10.14	-20.62	-30.69	-51.80	-62.23	-72.73	-83.24	-93.65	-98.04
6600	-0.31	-10.05	-20.53	-30.62	-51.74	-62.19	-72.64	-83.24	-93.85	-98.56
6800	-0.31	-10.00	-20.48	-30.58	-51.68	-62.11	-72.59	-83.18	-93.59	-98.46
7000	-0.30	-9.98	-20.46	-30.58	-51.64	-62.07	-72.56	-83.08	-93.44	-98.77
7200	-0.29	-10.01	-20.49	-30.63	-51.65	-62.06	-72.49	-83.02	-93.15	-98.69
7400	-0.29	-10.04	-20.55	-30.69	-51.66	-62.07	-72.43	-82.94	-93.29	-97.67
7600	-0.29	-10.06	-20.59	-30.74	-51.65	-62.02	-72.30	-82.87	-93.02	-97.34
7700	-0.29	-10.06	-20.61	-30.76	-51.64	-61.97	-72.22	-82.70	-92.93	-97.04
7800	-0.29	-10.07	-20.63	-30.79	-51.64	-61.94	-72.14	-82.53	-92.86	-97.10
7900	-0.30	-10.09	-20.67	-30.82	-51.64	-61.91	-72.03	-82.45	-92.84	-97.34
8000	-0.30	-10.12	-20.71	-30.86	-51.65	-61.89	-71.96	-82.31	-92.58	-96.88

Programmable Attenuator

RC4DAT-8G-95PE

Typical Performance Data

Test Conditions: @ Temperature = +25°C.

Freq. (MHz)	Attenuation accuracy relative to nominal attenuation setting (dB)									
	0.25 dB	10 dB	20 dB	30 dB	50 dB	60 dB	70 dB	80 dB	90 dB	95 dB
1	-0.04	-0.05	0.04	0.43	0.71	0.99	1.32	1.61	2.40	2.74
50	-0.04	-0.04	0.05	0.44	0.73	1.01	1.35	1.49	2.01	2.16
100	-0.04	-0.04	0.06	0.45	0.73	1.01	1.35	1.50	1.87	2.26
200	-0.04	0.01	0.11	0.51	0.79	1.07	1.42	1.54	1.96	2.30
300	-0.03	0.08	0.19	0.58	0.87	1.15	1.49	1.61	1.96	2.33
400	-0.03	0.15	0.27	0.67	0.95	1.23	1.58	1.70	2.07	2.25
600	-0.02	0.31	0.44	0.85	1.12	1.40	1.74	1.86	2.33	2.64
800	-0.01	0.41	0.56	0.97	1.23	1.51	1.84	1.96	2.35	2.78
1000	-0.01	0.44	0.60	1.01	1.26	1.53	1.85	1.99	2.32	2.80
1200	0.00	0.42	0.58	1.00	1.23	1.51	1.81	1.95	2.36	2.62
1400	0.00	0.40	0.56	0.98	1.19	1.46	1.75	1.89	2.26	2.46
1600	0.00	0.40	0.56	0.98	1.16	1.43	1.70	1.81	2.19	2.68
1800	0.00	0.42	0.57	0.99	1.15	1.39	1.64	1.82	2.27	2.32
2000	0.00	0.42	0.56	0.98	1.11	1.34	1.57	1.65	2.08	2.48
2200	0.00	0.40	0.52	0.94	1.03	1.25	1.48	1.47	1.74	2.13
2400	0.00	0.35	0.46	0.87	0.93	1.13	1.32	1.32	1.71	1.89
2600	0.00	0.30	0.39	0.79	0.81	0.99	1.14	1.10	1.28	1.52
2800	-0.01	0.25	0.31	0.70	0.68	0.85	0.97	0.97	1.10	1.37
3000	-0.01	0.20	0.24	0.62	0.55	0.71	0.78	0.69	0.85	0.86
3200	-0.02	0.17	0.17	0.54	0.42	0.55	0.60	0.46	0.72	0.64
3400	-0.02	0.15	0.13	0.48	0.30	0.42	0.42	0.26	0.49	0.66
3600	-0.02	0.16	0.11	0.45	0.21	0.30	0.27	0.04	-0.06	0.21
3800	-0.02	0.19	0.12	0.44	0.14	0.21	0.14	-0.12	-0.28	0.12
4000	-0.02	0.23	0.16	0.45	0.09	0.12	0.00	-0.28	-0.47	0.14
4200	-0.02	0.27	0.18	0.45	0.03	0.04	-0.14	-0.36	-0.53	-0.53
4400	-0.01	0.27	0.16	0.41	-0.07	-0.09	-0.32	-0.64	-0.76	-0.52
4600	-0.01	0.24	0.10	0.34	-0.21	-0.27	-0.54	-1.05	-0.87	-1.42
4800	-0.02	0.22	0.03	0.27	-0.36	-0.46	-0.74	-1.16	-1.37	-0.86
5000	-0.02	0.20	-0.03	0.19	-0.51	-0.66	-1.00	-1.49	-1.76	-1.90
5200	-0.02	0.17	-0.11	0.10	-0.70	-0.87	-1.25	-1.80	-1.89	-1.14
5400	-0.02	0.14	-0.19	-0.03	-0.90	-1.13	-1.52	-2.00	-2.13	-2.18
5600	-0.02	0.10	-0.26	-0.16	-1.10	-1.39	-1.80	-2.39	-2.54	-2.04
5800	-0.02	0.06	-0.35	-0.30	-1.31	-1.64	-2.07	-2.64	-3.00	-2.56
6000	-0.03	-0.02	-0.47	-0.47	-1.53	-1.88	-2.39	-2.84	-2.87	-3.59
6200	-0.05	-0.11	-0.59	-0.63	-1.72	-2.12	-2.62	-3.14	-3.31	-2.46
6400	-0.06	-0.14	-0.62	-0.69	-1.80	-2.23	-2.73	-3.24	-3.65	-3.04
6600	-0.06	-0.05	-0.53	-0.62	-1.74	-2.19	-2.64	-3.24	-3.85	-3.56
6800	-0.06	0.00	-0.48	-0.58	-1.68	-2.11	-2.59	-3.18	-3.59	-3.46
7000	-0.05	0.02	-0.46	-0.58	-1.64	-2.07	-2.56	-3.08	-3.44	-3.77
7200	-0.04	-0.01	-0.49	-0.63	-1.65	-2.06	-2.49	-3.02	-3.15	-3.69
7400	-0.04	-0.04	-0.55	-0.69	-1.66	-2.07	-2.43	-2.94	-3.29	-2.67
7600	-0.04	-0.06	-0.59	-0.74	-1.65	-2.02	-2.30	-2.87	-3.02	-2.34
7700	-0.04	-0.06	-0.61	-0.76	-1.64	-1.97	-2.22	-2.70	-2.93	-2.04
7800	-0.04	-0.07	-0.63	-0.79	-1.64	-1.94	-2.14	-2.53	-2.86	-2.10
7900	-0.05	-0.09	-0.67	-0.82	-1.64	-1.91	-2.03	-2.45	-2.84	-2.34
8000	-0.05	-0.12	-0.71	-0.86	-1.65	-1.89	-1.96	-2.31	-2.58	-1.88

Programmable Attenuator

RC4DAT-8G-95PE

Typical Performance Data

Test Conditions: @ Temperature = +25°C.

Freq. (MHz)	Return Loss In (dB)									
	0.25 dB	10 dB	20 dB	30 dB	50 dB	60 dB	70 dB	80 dB	90 dB	95 dB
1	-12.14	-21.69	-24.85	-32.94	-38.72	-33.39	-26.03	-25.95	-26.19	-25.23
50	-12.21	-21.83	-25.08	-34.50	-46.67	-35.79	-26.59	-26.50	-26.76	-25.69
100	-12.36	-21.90	-25.08	-34.34	-47.34	-36.12	-26.74	-26.64	-26.90	-25.84
200	-12.94	-22.30	-25.33	-34.59	-46.08	-36.05	-26.80	-26.71	-26.99	-25.91
300	-13.78	-22.86	-25.67	-35.05	-44.57	-35.80	-26.79	-26.70	-26.96	-25.90
400	-14.91	-23.56	-26.03	-35.52	-43.51	-35.57	-26.76	-26.67	-26.92	-25.88
600	-18.24	-25.51	-27.09	-37.50	-41.16	-34.58	-26.43	-26.34	-26.56	-25.58
800	-23.56	-27.65	-28.11	-39.73	-40.33	-33.99	-26.18	-26.09	-26.23	-25.34
1000	-33.74	-29.57	-29.09	-41.86	-39.18	-33.18	-25.82	-25.74	-25.75	-24.99
1200	-33.78	-30.50	-29.58	-40.48	-37.83	-32.39	-25.48	-25.40	-25.25	-24.66
1400	-27.21	-30.29	-29.29	-37.01	-36.43	-31.73	-25.27	-25.20	-24.84	-24.45
1600	-25.03	-29.54	-28.33	-34.05	-34.92	-31.17	-25.21	-25.13	-24.54	-24.37
1800	-25.13	-28.53	-26.97	-31.43	-32.94	-30.38	-25.18	-25.11	-24.26	-24.33
2000	-27.45	-27.44	-25.52	-29.44	-31.24	-29.70	-25.32	-25.25	-24.13	-24.46
2200	-28.44	-25.69	-23.96	-27.54	-29.43	-28.79	-25.54	-25.49	-24.07	-24.69
2400	-23.15	-23.58	-22.54	-26.01	-27.97	-27.99	-25.99	-25.97	-24.23	-25.16
2600	-18.51	-21.57	-21.32	-24.82	-26.88	-27.36	-26.73	-26.73	-24.66	-25.94
2800	-15.69	-19.93	-20.31	-23.84	-25.96	-26.72	-27.65	-27.70	-25.30	-26.94
3000	-14.15	-18.75	-19.45	-22.99	-25.13	-26.07	-29.00	-29.11	-26.40	-28.47
3200	-13.69	-18.13	-18.87	-22.36	-24.41	-25.46	-30.55	-30.71	-27.97	-30.43
3400	-14.17	-17.94	-18.45	-21.81	-23.60	-24.70	-31.65	-31.83	-30.17	-32.46
3600	-15.49	-18.10	-18.16	-21.28	-22.67	-23.78	-30.86	-30.98	-32.51	-32.49
3800	-17.71	-18.54	-17.99	-20.79	-21.70	-22.80	-28.50	-28.55	-32.55	-29.90
4000	-20.22	-18.96	-17.82	-20.21	-20.66	-21.72	-25.80	-25.82	-29.27	-26.73
4200	-20.91	-19.15	-17.67	-19.56	-19.64	-20.61	-23.33	-23.33	-25.78	-23.93
4400	-19.04	-18.90	-17.50	-18.84	-18.66	-19.51	-21.22	-21.21	-22.94	-21.61
4600	-17.24	-18.41	-17.34	-18.11	-17.79	-18.50	-19.48	-19.47	-20.72	-19.75
4800	-16.48	-17.90	-17.16	-17.39	-17.02	-17.60	-18.07	-18.05	-19.00	-18.27
5000	-16.70	-17.54	-16.99	-16.73	-16.35	-16.81	-16.90	-16.87	-17.61	-17.04
5200	-17.49	-17.37	-16.87	-16.15	-15.78	-16.15	-15.90	-15.86	-16.44	-15.99
5400	-18.11	-17.44	-16.93	-15.76	-15.41	-15.70	-15.15	-15.09	-15.53	-15.20
5600	-17.87	-17.46	-16.94	-15.32	-14.99	-15.21	-14.37	-14.30	-14.59	-14.39
5800	-17.92	-17.56	-16.96	-14.94	-14.63	-14.81	-13.69	-13.63	-13.77	-13.69
6000	-19.25	-17.55	-16.81	-14.52	-14.22	-14.38	-13.03	-12.97	-12.99	-13.02
6200	-21.55	-17.37	-16.58	-14.16	-13.86	-14.02	-12.47	-12.42	-12.32	-12.46
6400	-19.87	-16.64	-16.12	-13.70	-13.40	-13.55	-11.87	-11.83	-11.63	-11.86
6600	-16.10	-15.68	-15.72	-13.34	-13.04	-13.17	-11.35	-11.32	-11.03	-11.34
6800	-14.85	-15.07	-15.41	-13.12	-12.81	-12.92	-11.03	-11.01	-10.67	-11.03
7000	-14.15	-14.47	-15.10	-12.92	-12.64	-12.69	-10.71	-10.68	-10.29	-10.71
7200	-14.02	-13.96	-14.76	-12.78	-12.55	-12.53	-10.45	-10.43	-10.00	-10.45
7400	-13.61	-13.41	-14.32	-12.68	-12.52	-12.41	-10.25	-10.24	-9.76	-10.26
7600	-12.65	-12.75	-13.76	-12.60	-12.54	-12.34	-10.12	-10.11	-9.59	-10.12
7700	-12.07	-12.39	-13.43	-12.56	-12.56	-12.32	-10.07	-10.06	-9.52	-10.08
7800	-11.53	-12.02	-13.09	-12.51	-12.58	-12.30	-10.04	-10.03	-9.47	-10.04
7900	-11.08	-11.65	-12.75	-12.47	-12.60	-12.29	-10.02	-10.01	-9.43	-10.02
8000	-10.72	-11.30	-12.41	-12.43	-12.61	-12.28	-10.02	-10.00	-9.41	-10.02

Programmable Attenuator

RC4DAT-8G-95PE

Typical Performance Data

Test Conditions: @ Temperature = +25°C.

Freq. (MHz)	Return Loss Out (dB)									
	0.25 dB	10 dB	20 dB	30 dB	50 dB	60 dB	70 dB	80 dB	90 dB	95 dB
1	-12.14	-21.20	-39.67	-32.08	-28.15	-38.33	-38.25	-31.58	-28.58	-27.57
50	-12.21	-21.35	-47.65	-33.88	-28.94	-45.17	-44.97	-33.17	-29.45	-28.28
100	-12.33	-21.37	-45.42	-34.28	-29.20	-45.28	-45.13	-33.47	-29.67	-28.52
200	-12.77	-21.55	-43.04	-34.73	-29.48	-43.77	-43.74	-33.70	-29.94	-28.79
300	-13.38	-21.75	-40.55	-35.15	-29.76	-41.47	-41.51	-33.86	-30.21	-29.07
400	-14.24	-21.96	-38.52	-35.76	-30.14	-39.65	-39.73	-34.11	-30.58	-29.44
600	-16.90	-22.43	-35.75	-36.54	-30.78	-36.53	-36.61	-34.14	-31.14	-30.09
800	-21.53	-22.52	-33.76	-37.04	-31.59	-34.26	-34.31	-33.95	-31.78	-30.91
1000	-27.95	-21.96	-32.20	-36.71	-32.38	-32.56	-32.59	-33.44	-32.29	-31.73
1200	-25.01	-21.03	-30.95	-35.98	-33.25	-31.40	-31.40	-32.94	-32.73	-32.58
1400	-21.41	-20.25	-30.00	-35.27	-34.24	-30.71	-30.69	-32.63	-33.19	-33.54
1600	-20.80	-19.90	-29.28	-34.49	-35.10	-30.23	-30.20	-32.31	-33.46	-34.34
1800	-22.77	-19.94	-28.64	-33.64	-35.51	-29.81	-29.77	-31.88	-33.38	-34.77
2000	-27.92	-20.15	-28.03	-32.82	-35.58	-29.43	-29.39	-31.43	-33.12	-34.95
2200	-28.39	-20.23	-27.34	-31.93	-35.18	-29.02	-28.99	-30.90	-32.65	-34.79
2400	-22.01	-20.06	-26.69	-31.15	-34.51	-28.67	-28.64	-30.39	-32.09	-34.39
2600	-18.28	-19.66	-26.03	-30.32	-33.50	-28.25	-28.23	-29.78	-31.33	-33.64
2800	-15.97	-19.13	-25.41	-29.55	-32.64	-27.92	-27.92	-29.34	-30.73	-33.03
3000	-14.52	-18.65	-24.92	-28.88	-31.80	-27.66	-27.66	-28.96	-30.15	-32.35
3200	-13.63	-18.27	-24.56	-28.32	-31.12	-27.56	-27.56	-28.76	-29.72	-31.77
3400	-13.46	-18.10	-24.36	-27.89	-30.62	-27.67	-27.68	-28.80	-29.49	-31.33
3600	-14.26	-18.22	-24.35	-27.58	-30.35	-28.15	-28.15	-29.22	-29.56	-31.09
3800	-16.45	-18.64	-24.59	-27.48	-30.41	-29.21	-29.20	-30.24	-30.11	-31.20
4000	-19.96	-19.09	-24.98	-27.51	-30.72	-31.08	-31.06	-32.07	-31.23	-31.60
4200	-21.83	-19.22	-25.28	-27.48	-30.89	-33.90	-33.83	-34.87	-32.84	-31.90
4400	-20.81	-19.20	-25.51	-27.42	-30.74	-37.05	-36.92	-38.13	-34.86	-31.81
4600	-21.29	-19.49	-25.85	-27.38	-30.04	-34.97	-34.94	-36.02	-35.42	-30.92
4800	-24.18	-20.37	-26.59	-27.47	-28.88	-30.05	-30.06	-30.91	-32.67	-29.27
5000	-25.03	-21.57	-27.58	-27.40	-27.44	-26.48	-26.49	-27.26	-29.25	-27.37
5200	-24.19	-23.38	-28.96	-26.82	-25.62	-23.56	-23.56	-24.26	-26.02	-25.20
5400	-26.74	-26.88	-30.31	-25.77	-23.82	-21.26	-21.25	-21.88	-23.38	-23.21
5600	-33.11	-34.08	-28.86	-24.19	-22.12	-19.41	-19.40	-19.96	-21.20	-21.44
5800	-34.87	-31.88	-25.40	-22.51	-20.71	-18.05	-18.03	-18.52	-19.55	-20.04
6000	-44.97	-25.27	-22.07	-20.70	-19.35	-16.90	-16.89	-17.31	-18.13	-18.78
6200	-25.01	-20.78	-19.30	-18.97	-18.07	-15.93	-15.92	-16.25	-16.88	-17.63
6400	-17.35	-17.62	-17.25	-17.58	-17.04	-15.26	-15.25	-15.48	-15.90	-16.74
6600	-13.42	-15.18	-15.53	-16.32	-16.06	-14.72	-14.72	-14.82	-15.00	-15.90
6800	-12.53	-14.24	-14.79	-15.72	-15.57	-14.52	-14.52	-14.52	-14.55	-15.47
7000	-12.26	-13.44	-14.10	-15.15	-15.06	-14.40	-14.41	-14.27	-14.10	-15.03
7200	-12.55	-13.01	-13.69	-14.76	-14.70	-14.45	-14.46	-14.15	-13.78	-14.72
7400	-12.59	-12.78	-13.51	-14.56	-14.50	-14.69	-14.71	-14.19	-13.61	-14.55
7600	-12.11	-12.63	-13.50	-14.51	-14.45	-15.13	-15.15	-14.39	-13.58	-14.51
7700	-11.82	-12.58	-13.53	-14.53	-14.47	-15.42	-15.43	-14.54	-13.62	-14.54
7800	-11.63	-12.56	-13.57	-14.57	-14.51	-15.75	-15.76	-14.71	-13.68	-14.59
7900	-11.64	-12.56	-13.63	-14.62	-14.58	-16.13	-16.14	-14.92	-13.77	-14.66
8000	-11.92	-12.60	-13.69	-14.68	-14.67	-16.56	-16.57	-15.16	-13.89	-14.76

Programmable Attenuator

RC4DAT-8G-95PE

Typical Performance Data

Test Conditions: @ Temperature = +25°C.

Freq. (MHz)	I. Loss (dB)
1	-2.73
50	-2.79
100	-2.86
200	-2.99
300	-3.14
400	-3.30
600	-3.60
800	-3.86
1000	-4.03
1200	-4.16
1400	-4.29
1600	-4.44
1800	-4.60
2000	-4.76
2200	-4.90
2400	-5.01
2600	-5.13
2800	-5.26
3000	-5.40
3200	-5.56
3400	-5.75
3600	-5.98
3800	-6.26
4000	-6.57
4200	-6.89
4400	-7.19
4600	-7.46
4800	-7.69
5000	-7.88
5200	-7.99
5400	-8.01
5600	-8.01
5800	-8.01
6000	-8.00
6200	-8.03
6400	-8.19
6600	-8.55
6800	-8.80
7000	-9.07
7200	-9.31
7400	-9.54
7600	-9.82
7700	-9.96
7800	-10.11
7900	-10.25
8000	-10.39

Freq. (MHz)	IP3 (dBm)
1	44.79
5	49.71
10	50.03
50	57.56
100	52.82
200	53.65
300	53.47
400	55.19
500	55.72
600	53.83
700	55.00
800	54.94
900	52.22
1000	54.25
1500	52.74
2000	53.33
2500	55.12
3000	55.11
3500	53.93
4000	52.06
4500	52.08
5000	51.58
5500	48.17
6000	48.12
6500	50.26
7000	48.60
7500	51.30
8000	47.20

Programmable Attenuator

RC4DAT-8G-95PE

Typical Performance Data

Test Conditions: @ Temperature = +25°C.

Freq. (MHz)	Cross-Over Isolation (dB)									
	In1 - In2	In2 - In3	In3 - In4	Out1 - Out2	Out2 - Out3	Out3 - Out4	In1 - Out2	In2 - Out3	In3 - Out2	In4 - Out3
1	-112.00	-111.66	-113.28	-111.15	-114.58	-112.05	-113.92	-112.07	-114.69	-112.98
50	-130.57	-131.73	-129.89	-128.73	-130.05	-130.98	-127.47	-128.30	-128.51	-133.00
100	-128.35	-129.34	-129.77	-132.75	-131.93	-131.33	-128.49	-131.26	-129.69	-132.36
200	-131.55	-128.40	-131.61	-128.79	-132.79	-131.55	-129.59	-131.83	-129.66	-132.06
300	-128.24	-128.27	-132.42	-130.78	-130.51	-131.36	-132.36	-131.08	-133.94	-131.77
400	-127.88	-129.09	-131.94	-130.36	-130.01	-128.46	-130.29	-129.01	-133.40	-128.65
600	-128.06	-131.78	-131.39	-127.39	-130.48	-130.33	-131.48	-131.04	-129.22	-130.07
800	-126.98	-130.54	-129.17	-127.71	-129.66	-128.19	-128.06	-129.14	-131.89	-129.40
1000	-127.40	-128.91	-129.56	-129.46	-128.39	-129.44	-128.33	-129.39	-129.48	-129.16
1200	-129.64	-130.48	-130.25	-129.00	-129.45	-129.50	-130.32	-130.26	-128.53	-131.05
1400	-128.13	-127.71	-128.58	-128.74	-130.06	-128.60	-128.10	-128.42	-128.92	-130.48
1600	-129.76	-128.64	-126.14	-131.05	-130.76	-129.77	-128.95	-128.47	-130.54	-129.25
1800	-126.80	-127.16	-128.76	-129.42	-129.58	-128.23	-131.57	-130.33	-125.97	-127.13
2000	-126.40	-128.84	-129.69	-129.58	-129.60	-127.72	-128.46	-127.51	-130.44	-127.91
2200	-126.82	-130.49	-127.62	-126.78	-130.80	-129.01	-130.62	-130.94	-128.96	-127.96
2400	-129.23	-127.52	-128.67	-130.34	-129.39	-127.79	-128.65	-125.99	-128.70	-127.77
2600	-127.70	-128.18	-127.62	-127.05	-133.23	-126.76	-130.43	-130.04	-132.70	-131.69
2800	-126.38	-131.67	-130.04	-127.21	-127.86	-127.69	-128.63	-129.19	-128.25	-128.21
3000	-127.92	-131.68	-128.30	-128.27	-127.81	-127.27	-129.60	-128.61	-129.02	-127.74
3200	-127.93	-129.02	-130.65	-126.60	-128.59	-128.54	-126.39	-131.22	-129.22	-128.35
3400	-128.58	-127.37	-130.60	-129.62	-129.40	-128.59	-126.62	-128.21	-129.16	-127.31
3600	-124.31	-127.01	-126.95	-127.53	-128.53	-128.29	-128.66	-127.56	-126.50	-129.39
3800	-125.64	-130.85	-127.82	-129.51	-127.27	-127.40	-130.99	-127.88	-128.76	-127.68
4000	-127.87	-128.51	-127.51	-128.31	-131.29	-129.77	-127.87	-127.50	-127.23	-129.16
4200	-127.56	-129.64	-128.86	-129.64	-128.61	-128.00	-129.50	-127.77	-129.35	-126.76
4400	-126.00	-128.95	-127.88	-129.00	-126.85	-126.48	-128.32	-129.40	-129.15	-127.35
4600	-127.27	-130.09	-124.60	-129.32	-130.21	-125.41	-131.00	-125.82	-129.42	-129.11
4800	-124.89	-130.00	-124.34	-127.14	-128.04	-126.55	-130.02	-124.83	-126.21	-124.38
5000	-124.67	-124.86	-127.13	-126.95	-128.39	-128.61	-126.43	-126.82	-122.67	-128.00
5200	-128.17	-127.98	-125.84	-127.01	-126.65	-127.76	-129.17	-129.22	-128.04	-128.63
5400	-125.32	-126.17	-128.79	-130.95	-129.87	-128.16	-129.50	-130.60	-128.08	-128.64
5600	-128.55	-127.23	-128.80	-128.72	-127.06	-128.67	-127.30	-127.52	-126.74	-127.18
5800	-126.51	-126.26	-127.25	-121.01	-130.90	-130.65	-126.24	-127.95	-129.60	-128.29
6000	-125.82	-127.56	-126.96	-126.04	-128.02	-129.96	-126.49	-129.85	-124.62	-128.71
6200	-126.19	-129.81	-127.16	-128.30	-128.52	-127.52	-130.22	-131.21	-127.42	-125.81
6400	-128.39	-126.17	-125.84	-126.15	-126.76	-128.07	-129.36	-128.32	-125.97	-128.87
6600	-129.48	-125.70	-127.11	-126.62	-128.24	-128.33	-127.15	-128.18	-124.74	-129.62
6800	-123.13	-127.93	-125.06	-119.92	-125.28	-125.79	-126.83	-129.04	-127.60	-123.89
7000	-124.19	-125.04	-126.02	-125.49	-124.16	-123.44	-127.36	-127.41	-121.01	-124.92
7200	-120.82	-120.38	-120.74	-123.43	-113.67	-117.69	-121.64	-118.55	-118.80	-124.90
7400	-120.72	-120.93	-121.75	-127.27	-116.96	-122.16	-127.03	-129.66	-121.47	-122.33
7600	-121.05	-120.86	-120.48	-126.83	-121.33	-125.93	-126.38	-126.63	-122.93	-127.07
7700	-119.81	-121.01	-117.84	-125.04	-122.55	-123.63	-124.90	-125.44	-123.32	-121.84
7800	-117.95	-121.82	-117.22	-124.89	-123.91	-121.07	-125.04	-127.14	-119.94	-119.50
7900	-119.12	-119.78	-118.26	-123.19	-124.16	-122.76	-124.47	-130.82	-119.84	-119.26
8000	-118.93	-119.86	-117.92	-123.79	-123.52	-124.49	-124.84	-127.81	-118.38	-118.67

Programmable Attenuator

RC4DAT-8G-95PE

Typical Performance Data

Test Conditions: @ Temperature = +50°C.

Freq. (MHz)	Attenuation relative to Insertion Loss (dB)									
	0.25 dB	10 dB	20 dB	30 dB	50 dB	60 dB	70 dB	80 dB	90 dB	95 dB
1	-0.29	-9.98	-19.86	-29.43	-49.13	-58.83	-68.46	-78.14	-88.55	-93.21
50	-0.29	-9.98	-19.85	-29.43	-49.12	-58.83	-68.49	-78.34	-87.89	-92.71
100	-0.29	-9.97	-19.85	-29.42	-49.12	-58.83	-68.49	-78.34	-87.88	-92.55
200	-0.28	-9.92	-19.79	-29.36	-49.05	-58.77	-68.42	-78.25	-87.78	-92.49
300	-0.28	-9.84	-19.70	-29.27	-48.96	-58.67	-68.32	-78.16	-87.82	-92.50
400	-0.27	-9.77	-19.61	-29.17	-48.86	-58.57	-68.23	-78.05	-87.56	-92.32
600	-0.26	-9.62	-19.44	-28.99	-48.69	-58.39	-68.06	-77.87	-87.34	-91.94
800	-0.25	-9.53	-19.33	-28.88	-48.59	-58.29	-67.95	-77.79	-87.19	-92.06
1000	-0.25	-9.51	-19.30	-28.84	-48.56	-58.26	-67.95	-77.75	-87.43	-92.11
1200	-0.25	-9.53	-19.32	-28.85	-48.59	-58.29	-68.00	-77.83	-87.43	-92.01
1400	-0.25	-9.55	-19.34	-28.87	-48.63	-58.34	-68.05	-77.86	-87.47	-92.10
1600	-0.25	-9.55	-19.35	-28.88	-48.67	-58.38	-68.11	-77.96	-87.65	-92.21
1800	-0.25	-9.54	-19.35	-28.88	-48.69	-58.42	-68.17	-78.09	-87.66	-92.38
2000	-0.24	-9.53	-19.34	-28.88	-48.73	-58.47	-68.24	-78.17	-87.81	-92.27
2200	-0.24	-9.54	-19.37	-28.92	-48.80	-58.56	-68.37	-78.29	-88.02	-92.64
2400	-0.25	-9.59	-19.44	-29.00	-48.91	-58.69	-68.54	-78.45	-88.28	-93.07
2600	-0.25	-9.65	-19.53	-29.10	-49.06	-58.87	-68.73	-78.75	-88.46	-93.11
2800	-0.25	-9.73	-19.63	-29.21	-49.21	-59.04	-68.93	-78.98	-88.77	-93.36
3000	-0.26	-9.77	-19.71	-29.30	-49.34	-59.20	-69.13	-79.21	-89.07	-93.84
3200	-0.26	-9.79	-19.75	-29.34	-49.45	-59.33	-69.31	-79.35	-89.03	-93.80
3400	-0.27	-9.78	-19.76	-29.36	-49.52	-59.42	-69.44	-79.57	-89.43	-94.17
3600	-0.27	-9.76	-19.75	-29.37	-49.59	-59.52	-69.57	-79.71	-89.51	-94.06
3800	-0.27	-9.74	-19.76	-29.39	-49.66	-59.61	-69.71	-79.95	-89.87	-94.65
4000	-0.26	-9.73	-19.76	-29.41	-49.74	-59.72	-69.86	-80.14	-90.29	-94.66
4200	-0.27	-9.72	-19.78	-29.44	-49.84	-59.83	-70.00	-80.35	-90.29	-95.43
4400	-0.26	-9.72	-19.80	-29.48	-49.95	-59.98	-70.20	-80.60	-90.58	-95.39
4600	-0.26	-9.72	-19.83	-29.53	-50.07	-60.13	-70.41	-80.76	-90.97	-95.82
4800	-0.26	-9.73	-19.87	-29.59	-50.21	-60.33	-70.65	-81.00	-91.19	-96.17
5000	-0.26	-9.74	-19.92	-29.68	-50.37	-60.51	-70.92	-81.42	-91.35	-96.49
5200	-0.26	-9.75	-19.98	-29.77	-50.54	-60.74	-71.16	-81.64	-91.97	-96.59
5400	-0.26	-9.77	-20.03	-29.86	-50.71	-60.97	-71.44	-81.86	-91.93	-97.78
5600	-0.26	-9.80	-20.10	-29.98	-50.90	-61.21	-71.71	-82.29	-92.43	-97.96
5800	-0.27	-9.86	-20.20	-30.12	-51.12	-61.46	-72.01	-82.61	-92.52	-97.80
6000	-0.28	-9.95	-20.33	-30.28	-51.34	-61.74	-72.26	-82.80	-93.22	-98.26
6200	-0.30	-10.02	-20.43	-30.41	-51.51	-61.95	-72.53	-83.10	-93.12	-97.57
6400	-0.31	-10.02	-20.45	-30.44	-51.58	-62.06	-72.60	-83.18	-93.46	-97.84
6600	-0.31	-9.95	-20.37	-30.39	-51.54	-62.03	-72.58	-83.19	-93.12	-98.25
6800	-0.30	-9.91	-20.34	-30.37	-51.51	-62.01	-72.56	-83.04	-93.41	-98.40
7000	-0.30	-9.91	-20.34	-30.39	-51.51	-62.04	-72.54	-83.10	-93.26	-98.89
7200	-0.29	-9.94	-20.39	-30.45	-51.54	-62.06	-72.56	-83.10	-93.07	-98.91
7400	-0.29	-9.98	-20.45	-30.53	-51.58	-62.08	-72.56	-82.99	-93.08	-98.13
7600	-0.29	-10.00	-20.50	-30.60	-51.58	-62.05	-72.47	-82.83	-92.96	-97.47
7700	-0.29	-10.01	-20.52	-30.62	-51.58	-62.03	-72.38	-82.72	-93.15	-97.59
7800	-0.29	-10.02	-20.54	-30.65	-51.58	-61.99	-72.32	-82.69	-93.04	-97.59
7900	-0.30	-10.04	-20.57	-30.69	-51.58	-61.96	-72.20	-82.57	-92.96	-97.36
8000	-0.30	-10.07	-20.62	-30.74	-51.59	-61.94	-72.11	-82.47	-93.05	-97.10

Programmable Attenuator

RC4DAT-8G-95PE

Typical Performance Data

Test Conditions: @ Temperature = +50°C.

Freq. (MHz)	Attenuation accuracy relative to nominal attenuation setting (dB)									
	0.25 dB	10 dB	20 dB	30 dB	50 dB	60 dB	70 dB	80 dB	90 dB	95 dB
1	-0.04	0.02	0.14	0.57	0.87	1.17	1.54	1.86	1.45	1.79
50	-0.04	0.02	0.15	0.57	0.88	1.17	1.51	1.66	2.11	2.29
100	-0.04	0.03	0.15	0.58	0.88	1.17	1.51	1.66	2.12	2.45
200	-0.03	0.08	0.21	0.64	0.95	1.23	1.58	1.75	2.22	2.51
300	-0.03	0.16	0.30	0.73	1.04	1.33	1.68	1.84	2.18	2.50
400	-0.02	0.23	0.39	0.83	1.14	1.43	1.77	1.95	2.44	2.68
600	-0.01	0.38	0.56	1.01	1.31	1.61	1.94	2.13	2.66	3.06
800	0.00	0.47	0.67	1.12	1.41	1.71	2.05	2.21	2.81	2.94
1000	0.00	0.49	0.70	1.16	1.44	1.74	2.05	2.25	2.57	2.89
1200	0.00	0.47	0.68	1.15	1.41	1.71	2.00	2.17	2.57	2.99
1400	0.00	0.45	0.66	1.13	1.37	1.66	1.95	2.14	2.53	2.90
1600	0.00	0.45	0.65	1.12	1.33	1.62	1.89	2.04	2.35	2.79
1800	0.00	0.46	0.65	1.12	1.31	1.58	1.83	1.91	2.34	2.62
2000	0.01	0.47	0.66	1.12	1.27	1.53	1.76	1.83	2.19	2.73
2200	0.01	0.46	0.63	1.08	1.20	1.44	1.63	1.71	1.98	2.36
2400	0.00	0.41	0.56	1.00	1.09	1.31	1.46	1.55	1.72	1.93
2600	0.00	0.35	0.47	0.90	0.94	1.13	1.27	1.25	1.54	1.89
2800	0.00	0.27	0.37	0.79	0.79	0.96	1.07	1.02	1.23	1.64
3000	-0.01	0.23	0.29	0.70	0.66	0.80	0.87	0.79	0.93	1.16
3200	-0.01	0.21	0.25	0.66	0.55	0.67	0.69	0.65	0.97	1.20
3400	-0.02	0.22	0.24	0.64	0.48	0.58	0.56	0.43	0.57	0.83
3600	-0.02	0.24	0.25	0.63	0.41	0.48	0.43	0.29	0.49	0.94
3800	-0.02	0.26	0.24	0.61	0.34	0.39	0.29	0.05	0.13	0.35
4000	-0.01	0.27	0.24	0.59	0.26	0.28	0.14	-0.14	-0.29	0.34
4200	-0.02	0.28	0.22	0.56	0.16	0.17	0.00	-0.35	-0.29	-0.43
4400	-0.01	0.28	0.20	0.52	0.05	0.02	-0.20	-0.60	-0.58	-0.39
4600	-0.01	0.28	0.17	0.47	-0.07	-0.13	-0.41	-0.76	-0.97	-0.82
4800	-0.01	0.27	0.13	0.41	-0.21	-0.33	-0.65	-1.00	-1.19	-1.17
5000	-0.01	0.26	0.08	0.32	-0.37	-0.51	-0.92	-1.42	-1.35	-1.49
5200	-0.01	0.25	0.02	0.23	-0.54	-0.74	-1.16	-1.64	-1.97	-1.59
5400	-0.01	0.23	-0.03	0.14	-0.71	-0.97	-1.44	-1.86	-1.93	-2.78
5600	-0.01	0.20	-0.10	0.02	-0.90	-1.21	-1.71	-2.29	-2.43	-2.96
5800	-0.02	0.14	-0.20	-0.12	-1.12	-1.46	-2.01	-2.61	-2.52	-2.80
6000	-0.03	0.05	-0.33	-0.28	-1.34	-1.74	-2.26	-2.80	-3.22	-3.26
6200	-0.05	-0.02	-0.43	-0.41	-1.51	-1.95	-2.53	-3.10	-3.12	-2.57
6400	-0.06	-0.02	-0.45	-0.44	-1.58	-2.06	-2.60	-3.18	-3.46	-2.84
6600	-0.06	0.05	-0.37	-0.39	-1.54	-2.03	-2.58	-3.19	-3.12	-3.25
6800	-0.05	0.09	-0.34	-0.37	-1.51	-2.01	-2.56	-3.04	-3.41	-3.40
7000	-0.05	0.09	-0.34	-0.39	-1.51	-2.04	-2.54	-3.10	-3.26	-3.89
7200	-0.04	0.06	-0.39	-0.45	-1.54	-2.06	-2.56	-3.10	-3.07	-3.91
7400	-0.04	0.02	-0.45	-0.53	-1.58	-2.08	-2.56	-2.99	-3.08	-3.13
7600	-0.04	0.00	-0.50	-0.60	-1.58	-2.05	-2.47	-2.83	-2.96	-2.47
7700	-0.04	-0.01	-0.52	-0.62	-1.58	-2.03	-2.38	-2.72	-3.15	-2.59
7800	-0.04	-0.02	-0.54	-0.65	-1.58	-1.99	-2.32	-2.69	-3.04	-2.59
7900	-0.05	-0.04	-0.57	-0.69	-1.58	-1.96	-2.20	-2.57	-2.96	-2.36
8000	-0.05	-0.07	-0.62	-0.74	-1.59	-1.94	-2.11	-2.47	-3.05	-2.10

Programmable Attenuator

RC4DAT-8G-95PE

Typical Performance Data

Test Conditions: @ Temperature = +50°C.

Freq. (MHz)	Return Loss In (dB)									
	0.25 dB	10 dB	20 dB	30 dB	50 dB	60 dB	70 dB	80 dB	90 dB	95 dB
1	-11.81	-20.10	-22.51	-28.18	-35.18	-42.53	-29.43	-29.29	-29.73	-28.24
50	-11.87	-20.28	-22.74	-28.87	-38.44	-65.94	-30.29	-30.17	-30.70	-28.94
100	-12.05	-20.46	-22.92	-29.13	-39.09	-61.24	-30.13	-29.97	-30.47	-28.76
200	-12.59	-20.84	-23.22	-29.46	-39.74	-52.24	-30.01	-29.85	-30.29	-28.66
300	-13.34	-21.12	-23.30	-29.28	-38.69	-46.81	-30.26	-30.10	-30.48	-28.88
400	-14.27	-21.40	-23.27	-28.83	-37.05	-44.34	-30.89	-30.74	-31.04	-29.44
600	-17.29	-22.54	-23.58	-28.59	-35.76	-41.96	-31.64	-31.50	-31.58	-30.08
800	-22.20	-24.01	-23.99	-28.50	-34.85	-39.95	-32.23	-32.10	-31.83	-30.57
1000	-29.59	-25.51	-24.31	-28.42	-34.03	-38.41	-32.86	-32.72	-31.99	-31.06
1200	-27.90	-26.86	-24.60	-28.56	-33.71	-37.82	-33.27	-33.12	-31.94	-31.35
1400	-24.05	-27.72	-24.70	-28.70	-33.48	-37.43	-33.55	-33.37	-31.75	-31.52
1600	-23.31	-28.20	-24.69	-28.88	-33.44	-37.44	-33.62	-33.40	-31.42	-31.51
1800	-25.01	-28.29	-24.63	-29.10	-33.60	-37.55	-33.19	-32.96	-30.73	-31.11
2000	-28.50	-27.65	-24.41	-29.11	-33.55	-37.07	-32.59	-32.37	-29.90	-30.61
2200	-27.65	-26.35	-24.05	-28.93	-33.29	-36.13	-31.88	-31.69	-29.02	-30.04
2400	-22.58	-24.76	-23.56	-28.50	-32.65	-34.68	-31.06	-30.92	-28.10	-29.40
2600	-18.94	-23.22	-23.00	-27.96	-31.95	-33.47	-30.47	-30.37	-27.40	-28.96
2800	-16.69	-21.95	-22.45	-27.37	-31.22	-32.36	-29.96	-29.92	-26.81	-28.59
3000	-15.41	-20.97	-21.88	-26.66	-30.32	-31.23	-29.64	-29.65	-26.37	-28.39
3200	-14.94	-20.34	-21.41	-26.04	-29.57	-30.37	-29.66	-29.70	-26.17	-28.46
3400	-15.21	-20.07	-21.06	-25.56	-28.95	-29.73	-30.05	-30.12	-26.26	-28.87
3600	-16.15	-20.16	-20.82	-25.25	-28.41	-29.26	-30.88	-30.98	-26.63	-29.65
3800	-17.81	-20.57	-20.70	-25.11	-27.92	-28.95	-32.39	-32.50	-27.37	-30.98
4000	-20.27	-21.14	-20.57	-24.99	-27.22	-28.56	-35.35	-35.51	-28.77	-33.48
4200	-23.13	-21.63	-20.36	-24.75	-26.24	-27.86	-41.66	-42.29	-31.14	-38.64
4400	-23.53	-21.87	-20.25	-24.61	-25.36	-27.24	-47.89	-49.35	-34.76	-51.75
4600	-20.91	-21.65	-20.21	-24.37	-24.44	-26.40	-35.69	-35.75	-38.43	-38.15
4800	-19.14	-21.28	-20.30	-24.05	-23.62	-25.50	-30.32	-30.30	-34.06	-31.34
5000	-18.89	-21.06	-20.51	-23.40	-22.67	-24.27	-26.43	-26.40	-28.82	-27.03
5200	-20.25	-21.33	-20.99	-22.63	-21.78	-23.03	-23.52	-23.48	-24.94	-23.89
5400	-22.28	-21.92	-21.63	-21.76	-20.92	-21.83	-21.31	-21.26	-22.13	-21.54
5600	-22.55	-22.46	-22.13	-20.65	-19.92	-20.55	-19.38	-19.33	-19.82	-19.53
5800	-21.94	-22.80	-22.23	-19.50	-18.88	-19.31	-17.77	-17.71	-17.93	-17.86
6000	-23.33	-22.65	-21.58	-18.27	-17.75	-18.09	-16.37	-16.32	-16.36	-16.43
6200	-28.95	-21.84	-20.48	-17.10	-16.66	-16.95	-15.12	-15.07	-14.96	-15.15
6400	-25.50	-20.32	-19.30	-16.10	-15.71	-15.98	-14.06	-14.02	-13.79	-14.08
6600	-18.39	-18.09	-17.83	-15.00	-14.67	-14.90	-12.94	-12.90	-12.57	-12.95
6800	-16.56	-16.93	-17.00	-14.39	-14.09	-14.29	-12.32	-12.29	-11.91	-12.33
7000	-15.36	-15.81	-16.16	-13.80	-13.55	-13.69	-11.67	-11.64	-11.20	-11.67
7200	-14.85	-14.87	-15.35	-13.27	-13.09	-13.14	-11.10	-11.07	-10.59	-11.10
7400	-14.12	-13.97	-14.52	-12.81	-12.73	-12.69	-10.62	-10.60	-10.07	-10.62
7600	-12.91	-13.05	-13.68	-12.44	-12.46	-12.33	-10.25	-10.23	-9.66	-10.24
7700	-12.24	-12.58	-13.25	-12.27	-12.36	-12.18	-10.10	-10.08	-9.50	-10.09
7800	-11.61	-12.12	-12.82	-12.12	-12.27	-12.05	-9.98	-9.96	-9.36	-9.97
7900	-11.08	-11.67	-12.41	-11.98	-12.19	-11.94	-9.88	-9.86	-9.24	-9.87
8000	-10.65	-11.24	-12.01	-11.85	-12.12	-11.85	-9.80	-9.78	-9.15	-9.79

Programmable Attenuator

RC4DAT-8G-95PE

Typical Performance Data

Test Conditions: @ Temperature = +50°C.

Freq. (MHz)	Return Loss Out (dB)									
	0.25 dB	10 dB	20 dB	30 dB	50 dB	60 dB	70 dB	80 dB	90 dB	95 dB
1	-11.78	-19.55	-31.57	-40.75	-32.89	-34.56	-34.63	-39.64	-33.71	-31.97
50	-11.91	-19.82	-33.62	-48.41	-34.27	-38.41	-38.54	-45.99	-35.47	-33.13
100	-12.05	-19.91	-33.59	-48.52	-34.41	-38.30	-38.43	-45.47	-35.46	-33.17
200	-12.51	-20.18	-33.40	-43.46	-34.10	-37.50	-37.62	-41.55	-35.03	-32.99
300	-13.08	-20.20	-31.85	-40.78	-34.95	-34.80	-34.89	-39.38	-35.77	-33.94
400	-13.98	-20.37	-31.00	-39.79	-35.92	-33.39	-33.46	-38.54	-36.66	-34.98
600	-16.54	-20.87	-29.86	-36.59	-35.91	-31.33	-31.38	-35.39	-36.05	-35.41
800	-20.77	-21.09	-28.88	-34.46	-36.29	-29.62	-29.65	-33.29	-35.57	-36.29
1000	-25.83	-20.93	-28.34	-33.12	-36.17	-28.56	-28.57	-31.91	-34.73	-36.45
1200	-24.58	-20.46	-28.04	-32.32	-36.22	-27.94	-27.93	-31.12	-34.17	-36.57
1400	-21.52	-20.02	-27.82	-31.75	-36.10	-27.57	-27.56	-30.61	-33.67	-36.44
1600	-20.76	-19.86	-27.72	-31.49	-36.19	-27.51	-27.49	-30.46	-33.49	-36.50
1800	-22.16	-20.01	-27.50	-31.15	-35.71	-27.41	-27.39	-30.17	-32.99	-35.98
2000	-26.27	-20.25	-27.01	-30.54	-34.77	-27.19	-27.17	-29.71	-32.25	-35.10
2200	-29.15	-20.37	-26.39	-29.86	-33.67	-26.91	-26.90	-29.18	-31.42	-34.08
2400	-22.47	-20.10	-25.66	-29.12	-32.57	-26.62	-26.62	-28.66	-30.61	-33.09
2600	-17.91	-19.47	-24.96	-28.42	-31.54	-26.33	-26.33	-28.14	-29.81	-32.12
2800	-15.25	-18.68	-24.21	-27.63	-30.45	-25.99	-26.00	-27.59	-28.99	-31.09
3000	-13.85	-18.00	-23.57	-26.88	-29.47	-25.71	-25.73	-27.14	-28.25	-30.14
3200	-13.38	-17.60	-23.09	-26.24	-28.62	-25.51	-25.54	-26.79	-27.62	-29.30
3400	-13.67	-17.44	-22.74	-25.64	-27.83	-25.42	-25.44	-26.54	-27.08	-28.50
3600	-14.61	-17.49	-22.54	-25.12	-27.15	-25.51	-25.53	-26.49	-26.68	-27.79
3800	-16.13	-17.72	-22.55	-24.78	-26.70	-25.94	-25.95	-26.77	-26.56	-27.31
4000	-18.17	-18.04	-22.75	-24.59	-26.47	-26.89	-26.89	-27.53	-26.80	-27.07
4200	-20.36	-18.39	-23.08	-24.52	-26.38	-28.50	-28.49	-28.88	-27.45	-27.01
4400	-21.83	-18.84	-23.57	-24.65	-26.45	-30.97	-30.93	-30.95	-28.63	-27.16
4600	-22.01	-19.46	-24.24	-25.02	-26.68	-33.10	-33.08	-32.87	-30.20	-27.45
4800	-21.86	-20.23	-24.71	-25.06	-26.26	-30.84	-30.87	-31.21	-30.41	-26.95
5000	-22.98	-21.74	-25.61	-25.19	-25.63	-27.02	-27.05	-27.79	-28.99	-26.04
5200	-25.62	-24.24	-26.92	-25.20	-24.76	-23.95	-23.96	-24.78	-26.57	-24.80
5400	-28.49	-29.20	-28.40	-24.84	-23.61	-21.46	-21.46	-22.25	-24.01	-23.30
5600	-28.79	-42.14	-28.04	-23.92	-22.32	-19.54	-19.53	-20.26	-21.81	-21.81
5800	-32.08	-31.02	-24.95	-22.28	-20.80	-17.89	-17.88	-18.52	-19.81	-20.26
6000	-39.42	-24.13	-22.04	-20.82	-19.67	-16.83	-16.82	-17.38	-18.43	-19.16
6200	-22.62	-19.91	-19.28	-19.11	-18.35	-15.82	-15.81	-16.27	-17.09	-17.96
6400	-16.41	-16.96	-17.22	-17.74	-17.32	-15.15	-15.14	-15.49	-16.06	-17.05
6600	-13.07	-14.72	-15.53	-16.51	-16.36	-14.67	-14.67	-14.87	-15.16	-16.21
6800	-12.32	-13.87	-14.82	-15.95	-15.90	-14.55	-14.54	-14.63	-14.74	-15.82
7000	-12.12	-13.19	-14.21	-15.46	-15.48	-14.53	-14.53	-14.46	-14.35	-15.45
7200	-12.42	-12.83	-13.86	-15.13	-15.16	-14.65	-14.66	-14.40	-14.07	-15.16
7400	-12.55	-12.64	-13.69	-14.94	-14.96	-14.92	-14.92	-14.46	-13.89	-14.97
7600	-12.22	-12.54	-13.69	-14.89	-14.89	-15.35	-15.36	-14.64	-13.85	-14.90
7700	-12.01	-12.52	-13.73	-14.90	-14.89	-15.64	-15.64	-14.78	-13.87	-14.91
7800	-11.88	-12.53	-13.78	-14.94	-14.92	-15.96	-15.96	-14.95	-13.91	-14.94
7900	-11.92	-12.56	-13.84	-14.98	-14.97	-16.33	-16.32	-15.14	-13.98	-14.99
8000	-12.20	-12.64	-13.92	-15.05	-15.05	-16.75	-16.74	-15.37	-14.09	-15.07

Programmable Attenuator

RC4DAT-8G-95PE

Typical Performance Data

Test Conditions: @ Temperature = +50°C.

Freq. (MHz)	I. Loss (dB)
1	-2.85
50	-2.89
100	-2.96
200	-3.10
300	-3.27
400	-3.43
600	-3.75
800	-4.00
1000	-4.18
1200	-4.31
1400	-4.43
1600	-4.57
1800	-4.72
2000	-4.87
2200	-5.00
2400	-5.09
2600	-5.16
2800	-5.24
3000	-5.35
3200	-5.52
3400	-5.71
3600	-5.92
3800	-6.14
4000	-6.35
4200	-6.57
4400	-6.76
4600	-6.96
4800	-7.13
5000	-7.27
5200	-7.41
5400	-7.54
5600	-7.66
5800	-7.76
6000	-7.84
6200	-7.97
6400	-8.21
6600	-8.63
6800	-8.89
7000	-9.20
7200	-9.46
7400	-9.72
7600	-10.02
7700	-10.17
7800	-10.33
7900	-10.48
8000	-10.62

Freq. (MHz)	IP3 (dBm)
1	42.81
5	51.11
10	51.91
50	51.42
100	51.00
200	52.64
300	53.55
400	55.60
500	55.60
600	55.40
700	54.19
800	53.94
900	53.54
1000	54.46
1500	54.45
2000	54.45
2500	55.38
3000	54.63
3500	51.75
4000	51.07
4500	49.07
5000	52.48
5500	47.31
6000	47.65
6500	47.71
7000	50.48
7500	51.49
8000	46.56

Programmable Attenuator

RC4DAT-8G-95PE

Typical Performance Graphs

Test Conditions: @ Temperature = 0°C.

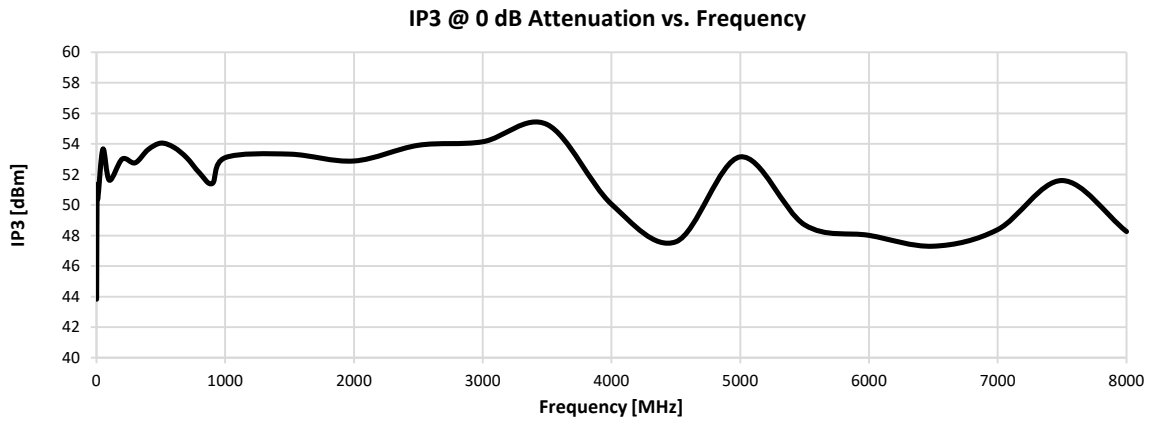
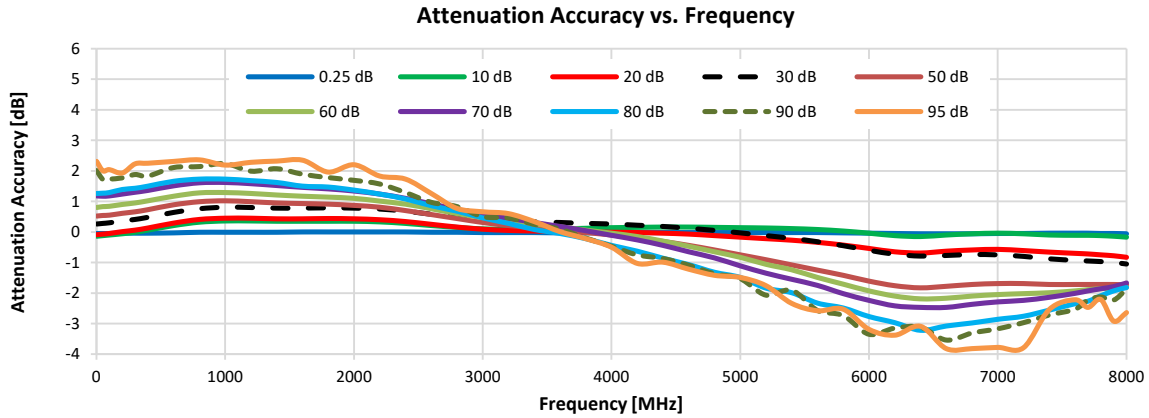

Programmable Attenuator

RC4DAT-8G-95PE

Typical Performance Graphs

Test Conditions: @ Temperature = 0°C.

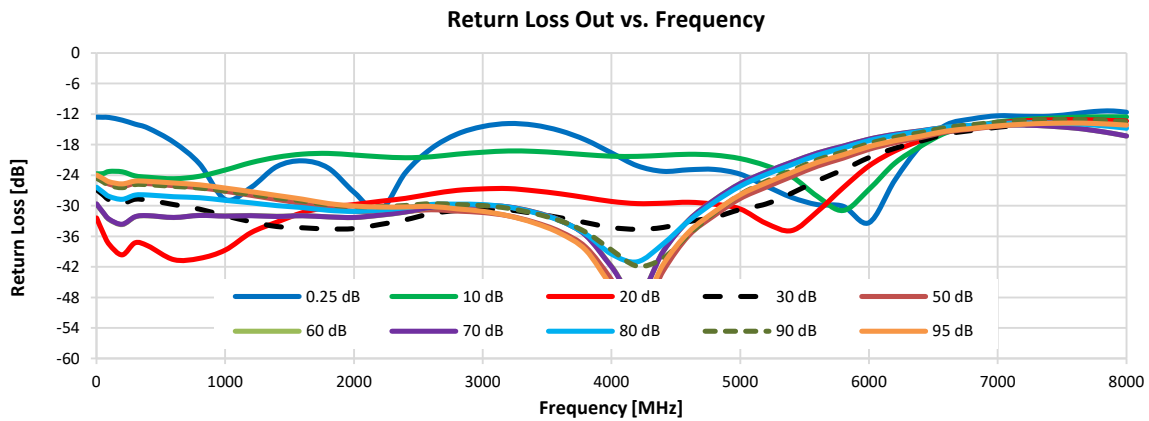
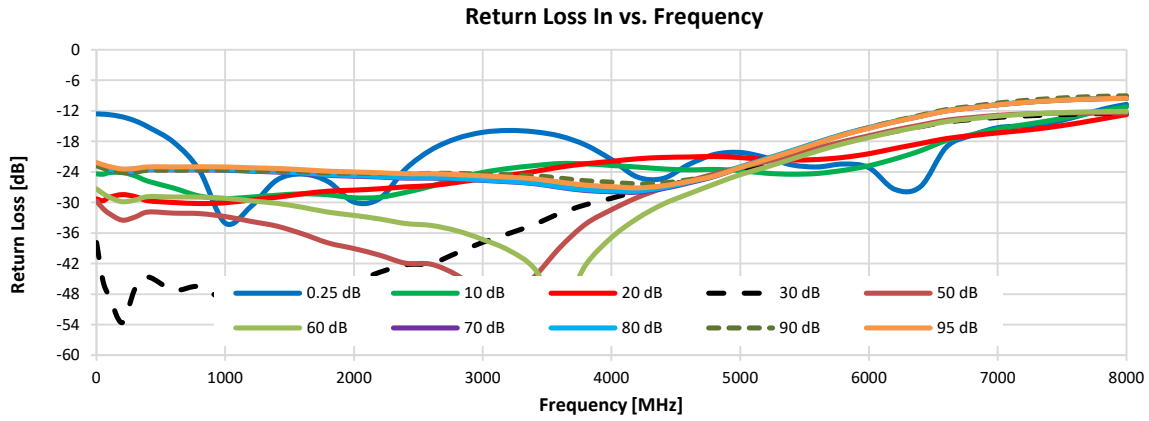

Typical Performance Graphs

Test Conditions: @ Temperature = +25°C.

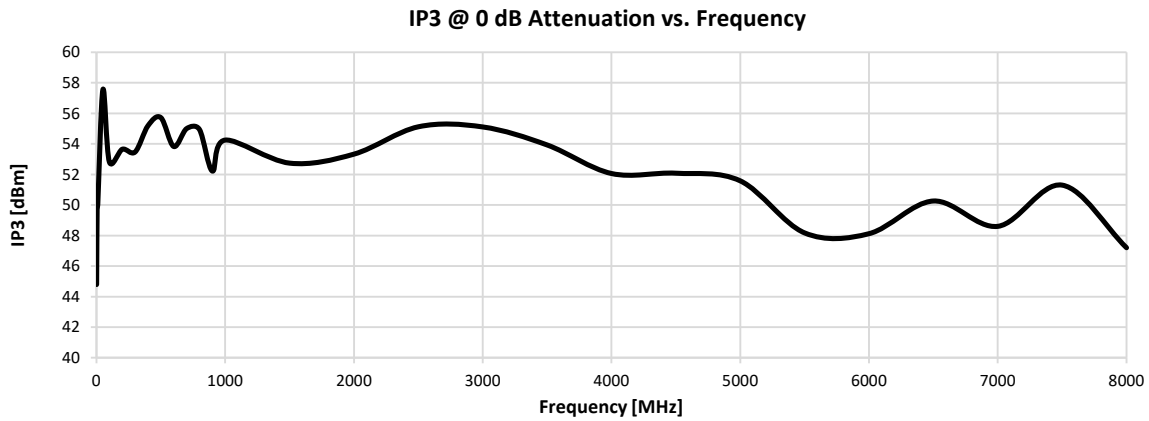
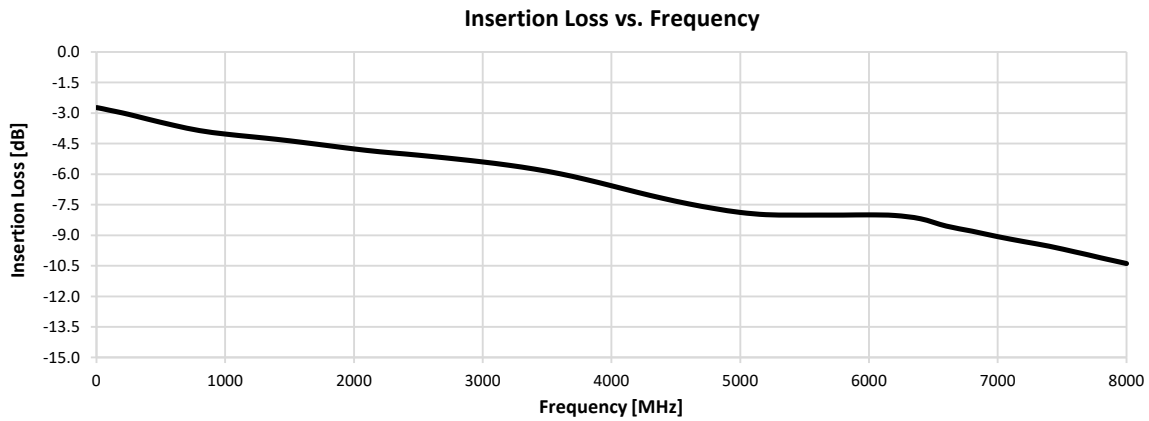
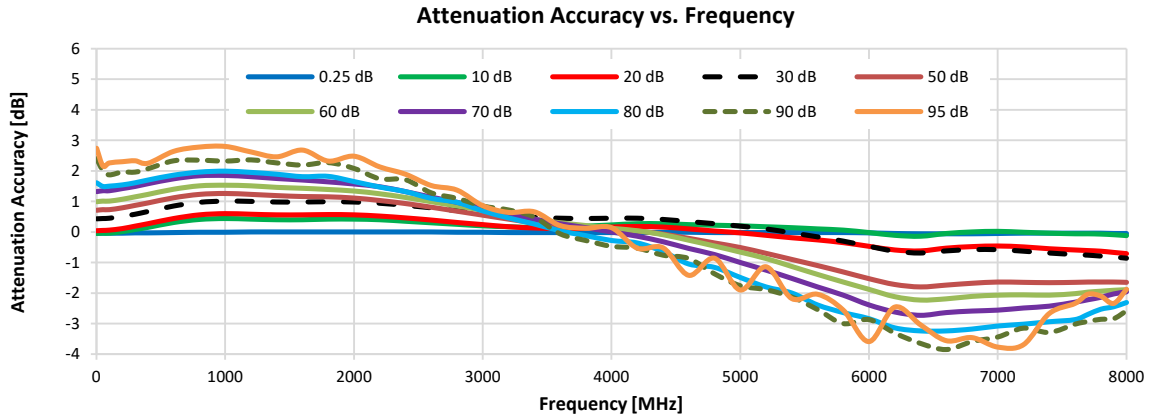

Typical Performance Graphs

Test Conditions: @ Temperature = +25°C.

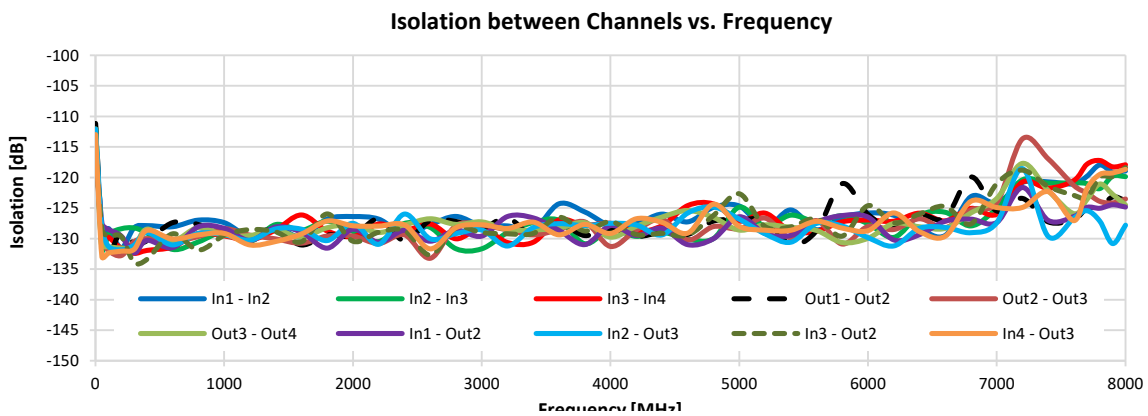
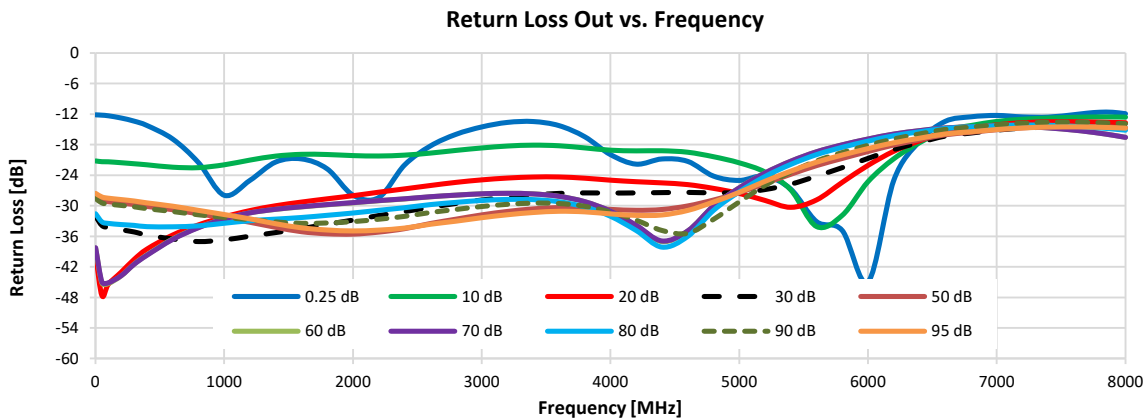
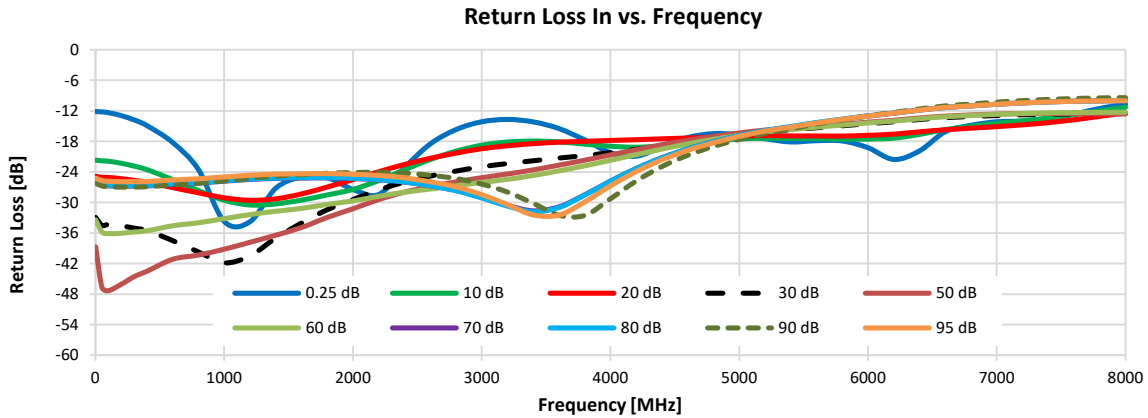

Typical Performance Graphs

Test Conditions: @ Temperature = +50°C.

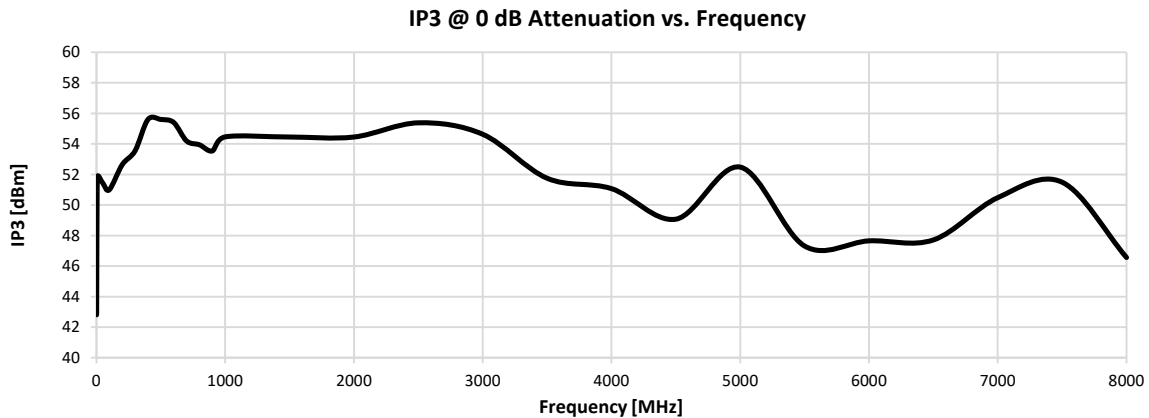
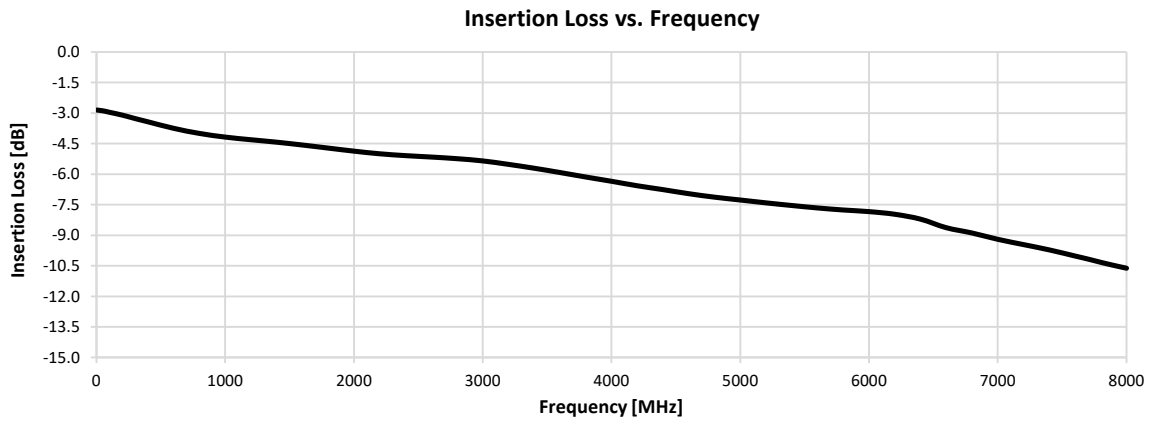
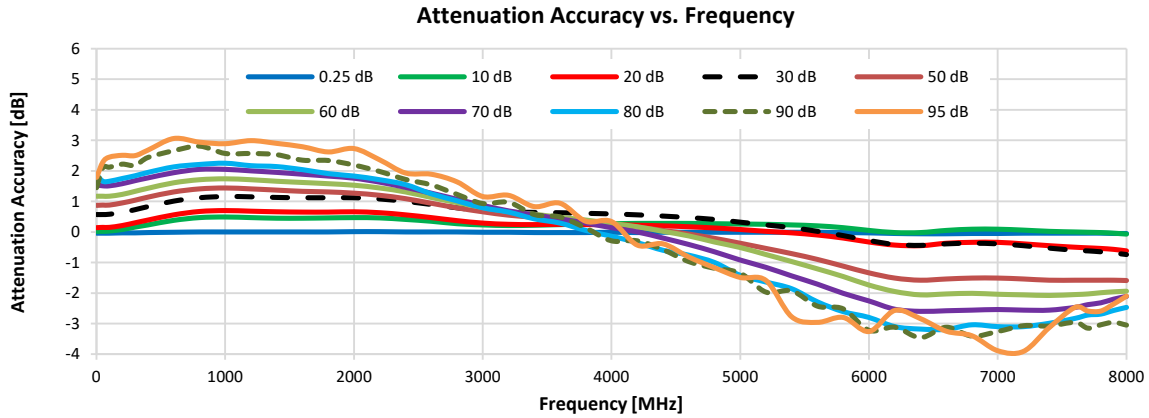

Typical Performance Graphs

Test Conditions: @ Temperature = +50°C.

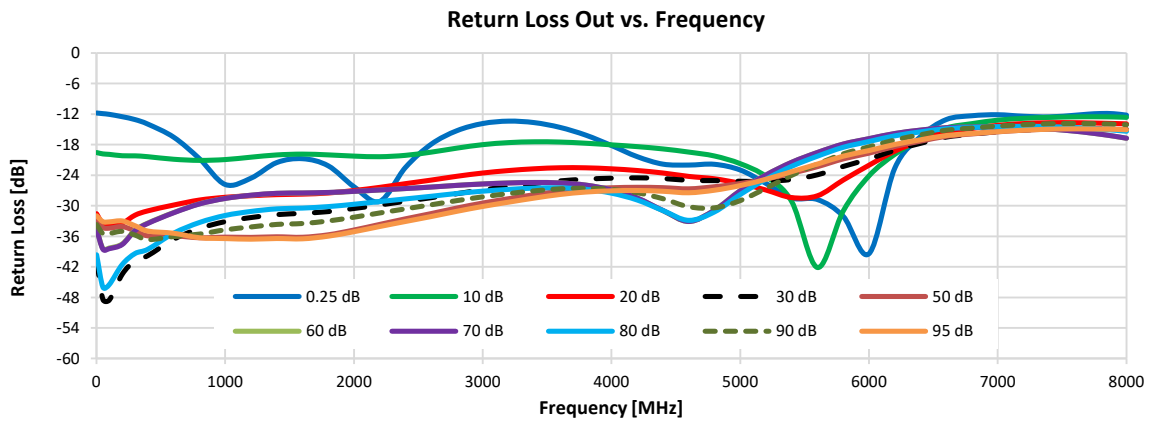
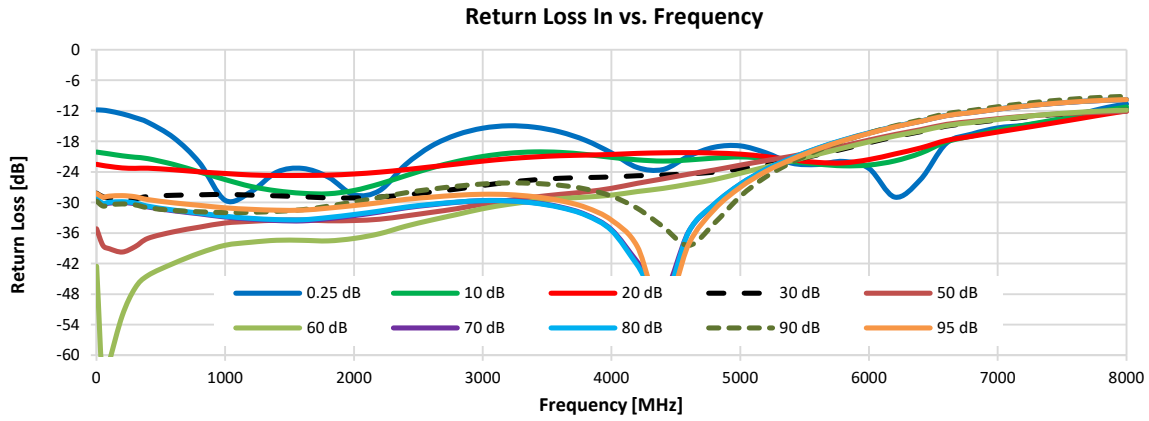

Case Style

QE

Outline Dimensions

QE2972

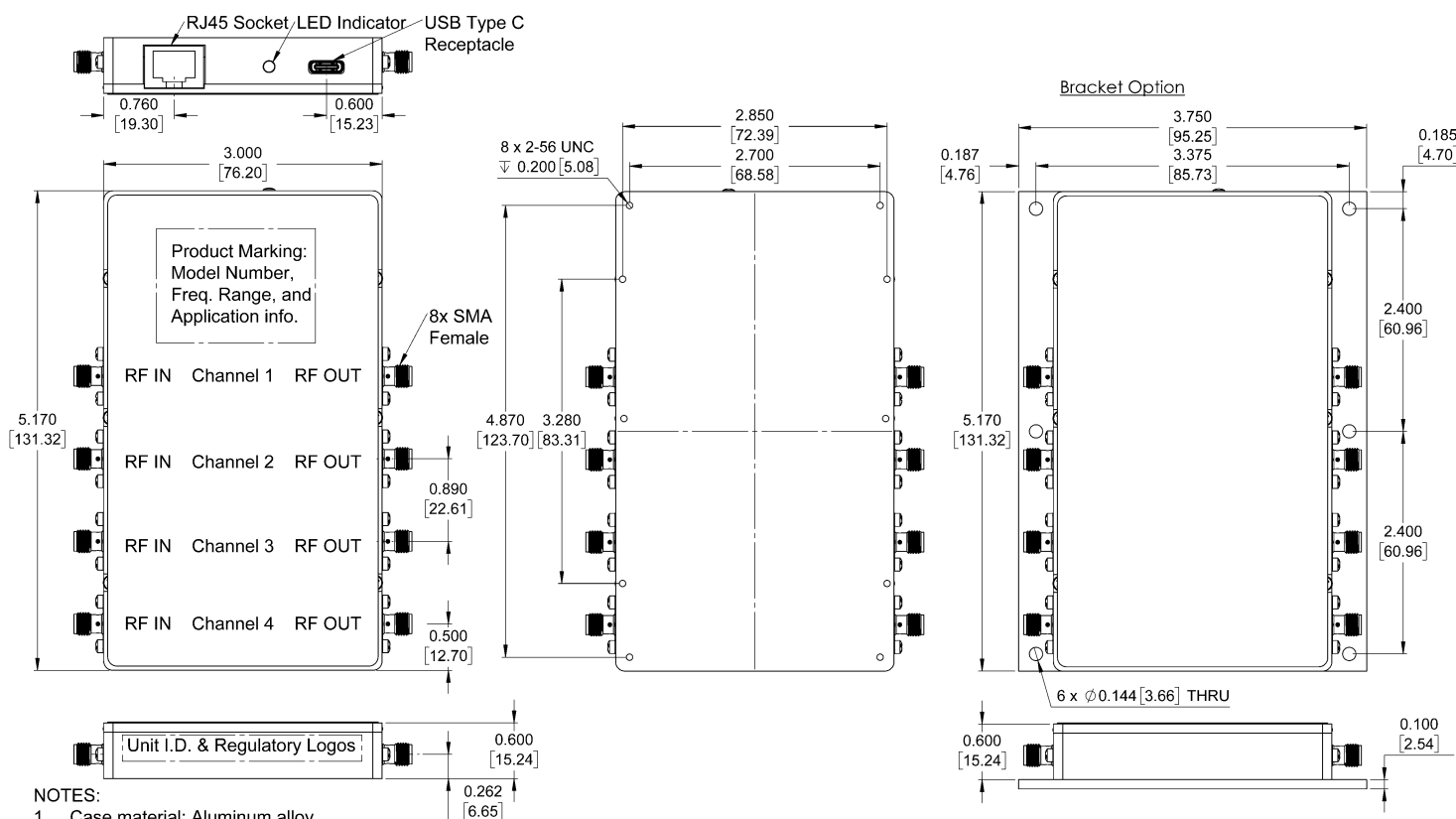

NOTES:

1. Case material: Aluminum alloy.
2. Case Finish: Nickel Plate.
3. Dimensions: Inches [mm]. Tolerances 2 Pl. ± 0.03 inch; 3 Pl. ± 0.015 inch.
4. Weight: 300 grams
5. Marking may contain other features or characters for internal lot control.



www.minicircuits.com P.O. Box 350166, Brooklyn, NY 11235-0003 (718) 934-4500 sales@minicircuits.com



Environmental Specifications **ENV55T1**

All Mini-Circuits products are manufactured under exacting quality assurance and control standards, and are capable of meeting published specifications after being subjected to any or all of the following physical and environmental test.

Specification	Test/Inspection Condition	Reference/Spec
Operating Temperature	-0° to 50° C Ambient Environment	Individual Model Data Sheet
Storage Temperature	-20° to 85° C Ambient Environment	Individual Model Data Sheet
Operating and Storage Humidity	5% to 85% RH (non-condensing)	Ambient
Bench Handling Test	Bench Top Tip 45° & Drop	MIL-PRF-28800F
Transit Drop Test	Free Fall Drop, 20 cm (7.9 inches)	MIL-PRF-28800F Class 3