

Surface Mount
Diplexer

RDP-50-2R15+

50Ω DC to 2150 MHz
(DC-50, 950-2150 MHz)



CASE STYLE: CK605

The Big Deal

- Low insertion loss
- High stopband insertion loss
- Miniature shielded package

Product Overview

RDP-50-2R15+ is a low-pass + high-pass combination device. Low pass port is designed for DC to 50 MHz and high pass port is designed for 950 to 2150 MHz. This diplexer can be used to pass, IF, pilot carrier or clock synchronizing signal, SATCOM modems, air-traffic control and other multiband radio systems.

Key Features

Feature	Advantages
Low passband insertion loss	Suitable for high performance application.
Extended stopband rejection	Spurious rejection and avoids using additional filters.
Shielded case.	Reduced interference with the surrounding components.

Notes

A. Performance and quality attributes and conditions not expressly stated in this specification document are intended to be excluded and do not form a part of this specification document.
B. Electrical specifications and performance data contained in this specification document are based on Mini-Circuit's applicable established test performance criteria and measurement instructions.
C. The parts covered by this specification document are subject to Mini-Circuits standard limited warranty and terms and conditions (collectively, "Standard Terms"); Purchasers of this part are entitled to the rights and benefits contained therein. For a full statement of the Standard Terms and the exclusive rights and remedies thereunder, please visit Mini-Circuits' website at www.minicircuits.com/MCLStore/terms.jsp

Surface Mount Diplexer

RDP-50-2R15+

50Ω DC to 2150 MHz (DC-50, 950-2150 MHz)



CASE STYLE: CK605

+RoHS Compliant
The +Suffix identifies RoHS Compliance. See our web site for RoHS Compliance methodologies and qualifications

Maximum Ratings

Operating Temperature	-40°C to 85°C
Storage Temperature	-55°C to 100°C
RF Power Input	1W at 25°C

Permanent damage may occur if any of these limits are exceeded. These ratings are not intended for continuous normal operation

Pin Connections

HIGH PASS PORT	10
LOW PASS PORT	14
COMMON PORT	2
GROUND	1,3-9,11-13,15,16

Outline Drawing

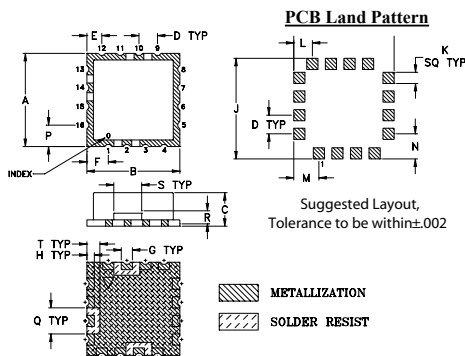

Outline Dimensions (inch)

A	B	C	D	E	F	G	H	J	K
.500	.500	.180	.100	.080	.115	.060	.040	.540	.060
12.7	12.7	4.572	2.54	2.032	2.921	1.524	1.016	13.72	1.524

L	M	N	P	Q	R	S	T	Wt.
.100	.135	.135	.115	.140	.070	.150	.070	grams
2.54	3.429	3.429	2.921	3.556	1.778	3.81	1.778	1.0

Demo Board MCL P/N: TB-10+ Suggested PCB Layout (PL-012)

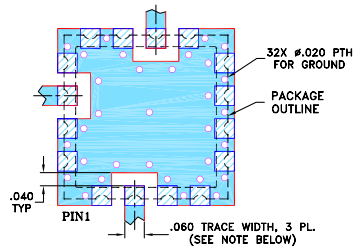

- NOTES: 1. TRACE WIDTH IS SHOWN FOR FR4 WITH DIELECTRIC THICKNESS .030" ± .002"; COPPER: 1/2 OZ. EACH SIDE. FOR OTHER MATERIALS TRACE WIDTH MAY NEED TO BE MODIFIED.
 2. BOTTOM SIDE OF THE PCB IS CONTINUOUS GROUND PLANE.
- DENOTES PCB COPPER LAYOUT WITH SMOBC (SOLDER MASK OVER BARE COPPER)
 DENOTES COPPER LAND PATTERN FREE OF SOLDER MASK

Notes

- A. Performance and quality attributes and conditions not expressly stated in this specification document are intended to be excluded and do not form a part of this specification document.
 B. Electrical specifications and performance data contained in this specification document are based on Mini-Circuits' applicable established test performance criteria and measurement instructions.
 C. The parts covered by this specification document are subject to Mini-Circuits' standard limited warranty and terms and conditions (collectively, "Standard Terms"); Purchasers of this part are entitled to the rights and benefits contained therein. For a full statement of the Standard Terms and the exclusive rights and remedies thereunder, please visit Mini-Circuits' website at www.minicircuits.com/MCLStore/terms.jsp

Features

- Low insertion loss
- 50Ω Impedance
- Combination of Low pass and High pass filters
- Miniature shielded package
- Aqueous washable

Applications

- SATCOM modem
- Air-traffic control

Electrical Specifications at 25°C

Parameter	Port	Frequency (MHz)	Min.	Typ.	Max.	Unit			
Pass Band	Insertion Loss	Low Pass	DC-50	-	0.5	1.0	dB		
		High Pass	950-2150	-	0.3	1.0			
	Return Loss	Flatness	High pass	950-2150	-	± 0.1	-	dB	
		Low Pass	DC-50	15	22	-	dB		
			High Pass	950-2150	15	22			-
			Common	DC-50	15	22			-
Stop Band Isolation	Low Pass	150-950	25	34	-	dB			
		950-2150	40	53	-				
	High Pass	50-250	25	32	-	dB			
DC-50	60	74	-						

Typical Performance Data at 25°C

FREQUENCY (MHz)	INSERTION LOSS (dB)			RETURN LOSS (dB)	
	Low Pass Port	High Pass Port	Common Port	Low Pass Port	High Pass Port
1	0.17	100.77	36.90	37.13	0.05
6	0.18	103.55	29.95	29.69	0.04
50	0.45	89.18	24.50	22.94	0.03
56	0.53	87.99	20.84	19.89	0.03
72	2.08	83.82	6.49	6.28	0.03
78	3.97	82.25	3.58	3.44	0.04
82	5.68	83.66	2.41	2.30	0.04
112	20.10	69.85	0.42	0.43	0.04
130	27.19	62.78	0.29	0.30	0.05
140	30.64	59.39	0.25	0.27	0.06
150	33.83	56.20	0.23	0.24	0.06
250	57.76	32.77	0.17	0.11	0.16
264	60.68	30.27	0.18	0.10	0.19
326	80.43	20.50	0.27	0.07	0.33
496	66.85	3.06	3.98	0.05	4.19
520	66.66	2.07	5.61	0.04	5.83
685	69.06	0.35	20.41	0.05	20.61
950	66.50	0.21	27.63	0.06	29.44
1500	81.05	0.18	22.60	0.11	26.52
1800	61.62	0.17	24.45	0.12	30.63
2000	55.30	0.17	28.52	0.13	39.82
2150	51.83	0.17	32.48	0.14	33.86

Functional Schematic

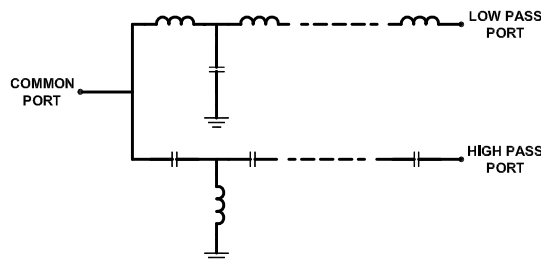

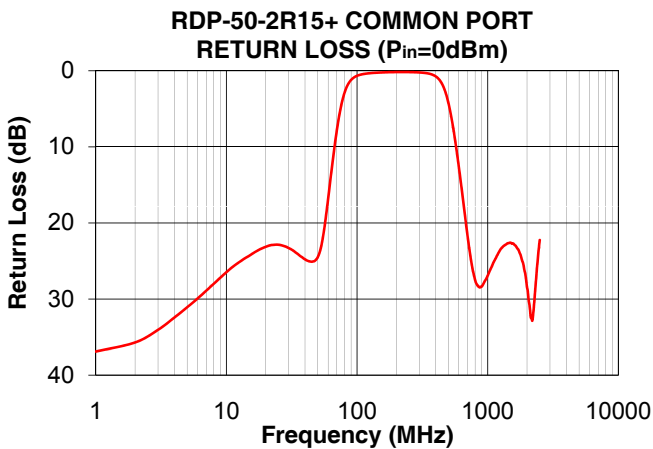
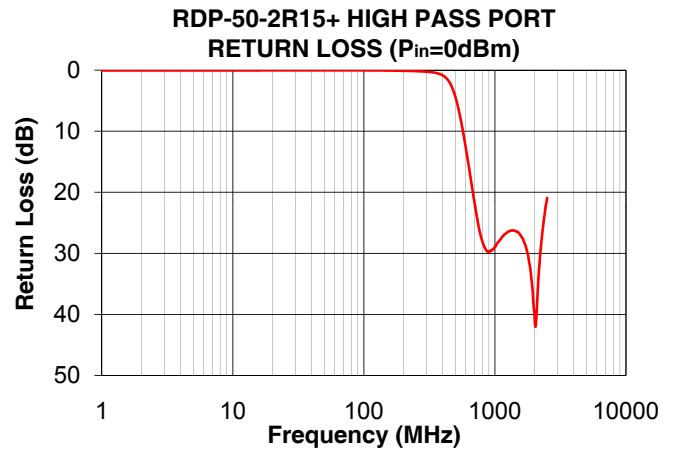
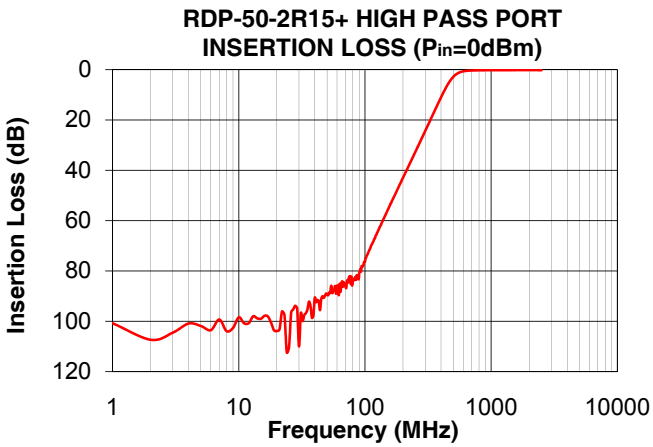
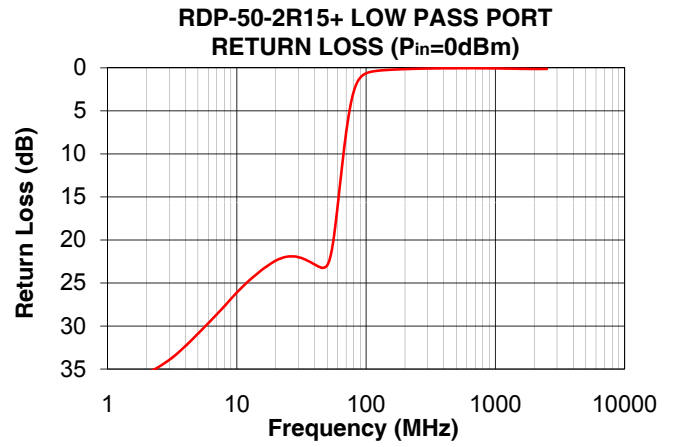
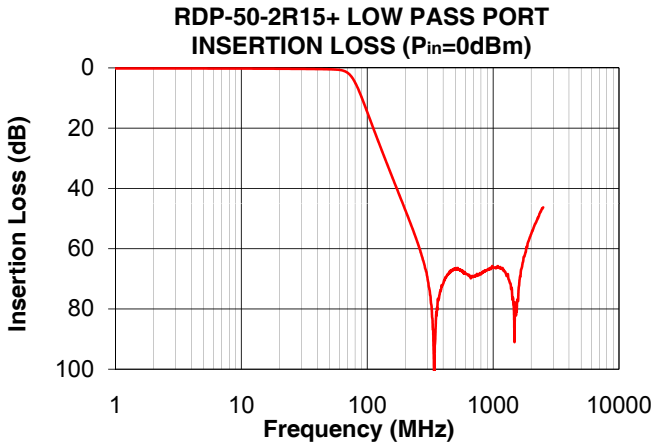

Notes

- A. Performance and quality attributes and conditions not expressly stated in this specification document are intended to be excluded and do not form a part of this specification document.
- B. Electrical specifications and performance data contained in this specification document are based on Mini-Circuit's applicable established test performance criteria and measurement instructions.
- C. The parts covered by this specification document are subject to Mini-Circuits standard limited warranty and terms and conditions (collectively, "Standard Terms"); Purchasers of this part are entitled to the rights and benefits contained therein. For a full statement of the Standard Terms and the exclusive rights and remedies thereunder, please visit Mini-Circuits' website at www.minicircuits.com/MCLStore/terms.jsp



Surface Mount Diplexer

RDP-50-2R15+

Typical Performance Data

FREQUENCY (MHz)	INSERTION LOSS (dB)		Cross over isolation (dB) (between LPF and HPF)	RETURN LOSS (dB)		
	Lowpass port	Highpass port		Common port	Lowpass port	Highpass port
1	0.17	100.77	104.35	36.90	37.13	0.05
2	0.17	107.35	99.47	35.70	35.49	0.05
5	0.18	101.87	106.98	31.09	30.89	0.05
10	0.21	98.41	97.74	26.47	26.11	0.04
15	0.24	98.98	102.34	24.29	23.69	0.04
23	0.28	97.51	100.24	22.88	22.03	0.04
27	0.30	95.27	96.60	22.98	21.91	0.04
29	0.31	94.94	99.56	23.17	21.95	0.04
30	0.32	109.99	94.68	23.30	22.02	0.04
33	0.33	97.59	99.69	23.72	22.22	0.04
37	0.35	93.95	100.48	24.38	22.57	0.03
41	0.38	92.39	89.38	24.90	22.94	0.03
46	0.41	90.08	93.15	25.06	23.25	0.03
50	0.45	89.18	93.22	24.50	22.94	0.03
56	0.53	87.99	87.53	20.84	19.89	0.03
61	0.69	85.87	83.87	15.83	15.26	0.03
63	0.80	85.08	85.65	13.81	13.35	0.03
72	2.08	83.82	79.18	6.49	6.28	0.03
76	3.24	82.13	77.47	4.38	4.22	0.03
83	6.14	83.45	75.69	2.19	2.09	0.04
92	10.63	79.28	73.54	1.04	0.99	0.04
100	14.61	76.32	73.10	0.66	0.64	0.04
112	20.10	69.85	72.09	0.42	0.43	0.04
126	25.72	64.49	71.62	0.31	0.32	0.05
139	30.31	59.76	69.88	0.26	0.27	0.06
150	33.83	56.20	69.88	0.23	0.24	0.06
157	35.93	54.10	69.41	0.21	0.22	0.07
160	36.80	53.20	69.04	0.21	0.22	0.07
170	39.58	50.45	69.02	0.19	0.19	0.08
240	55.67	34.64	67.10	0.17	0.12	0.15
250	57.76	32.77	67.05	0.17	0.11	0.16
264	60.68	30.27	67.16	0.18	0.10	0.19
282	64.69	27.23	66.85	0.20	0.09	0.21
328	82.85	20.21	67.75	0.27	0.07	0.33
370	76.74	14.59	69.91	0.46	0.06	0.55
440	68.26	6.97	77.64	1.52	0.05	1.68
496	66.85	3.06	71.43	3.98	0.05	4.19
522	66.52	2.01	69.26	5.76	0.05	5.98
540	66.97	1.50	68.08	7.18	0.04	7.41
576	67.42	0.88	67.22	10.33	0.05	10.59
660	69.25	0.39	67.38	18.18	0.04	18.39
720	69.10	0.31	67.99	23.21	0.05	23.41
785	68.10	0.26	67.87	26.92	0.05	27.42
810	68.32	0.25	67.57	27.79	0.05	28.37
815	68.10	0.25	67.51	27.91	0.05	28.52
900	67.06	0.22	66.77	28.33	0.06	29.71
950	66.50	0.21	66.16	27.63	0.06	29.44
990	66.01	0.21	66.12	27.07	0.07	29.05
1060	66.41	0.20	65.72	25.92	0.07	28.16
1140	66.08	0.20	66.18	24.77	0.08	27.25
1230	67.37	0.19	67.06	23.70	0.09	26.63
1390	73.36	0.19	72.07	22.78	0.10	26.28
1480	90.92	0.18	78.81	22.59	0.11	26.44
1500	81.05	0.18	88.85	22.60	0.11	26.52
1790	61.92	0.17	61.19	24.30	0.12	30.37
2000	55.30	0.17	55.01	28.52	0.13	39.82
2120	52.58	0.17	52.48	31.95	0.14	36.09
2150	51.83	0.17	52.01	32.48	0.14	33.86
2210	50.94	0.17	50.66	32.49	0.14	30.36
2500	46.29	0.22	46.53	22.24	0.12	20.93



Surface Mount Diplexer

Typical Performance Curves

RDP-50-2R15+

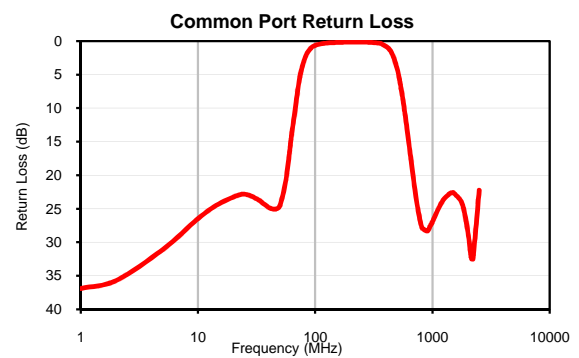
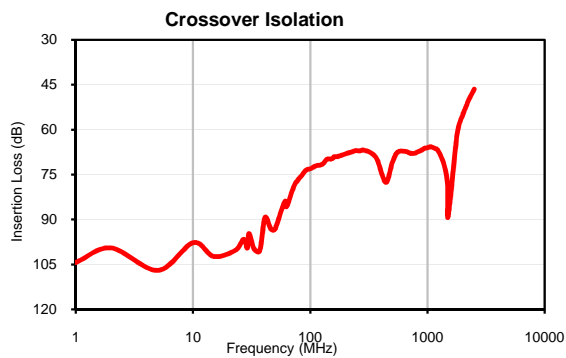
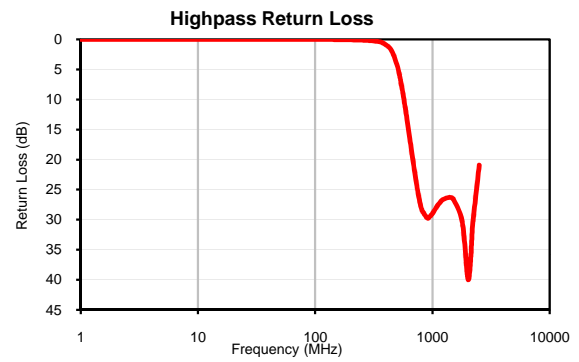
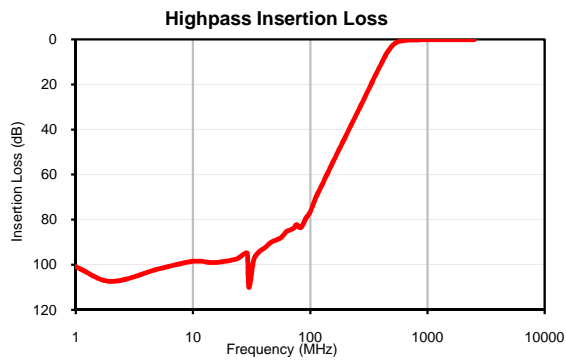
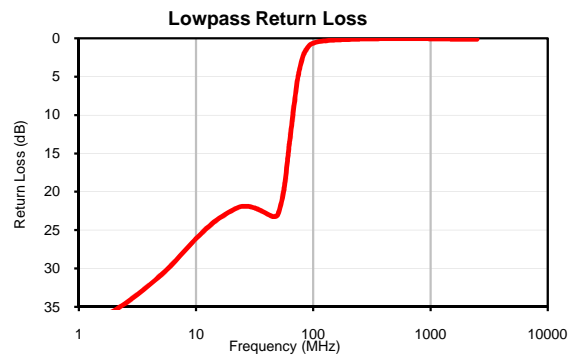
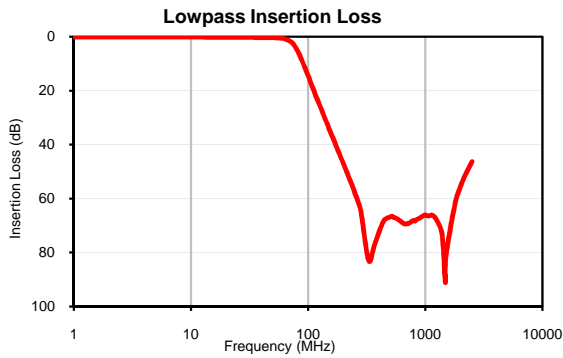

Outline Dimensions

PCB Land Pattern

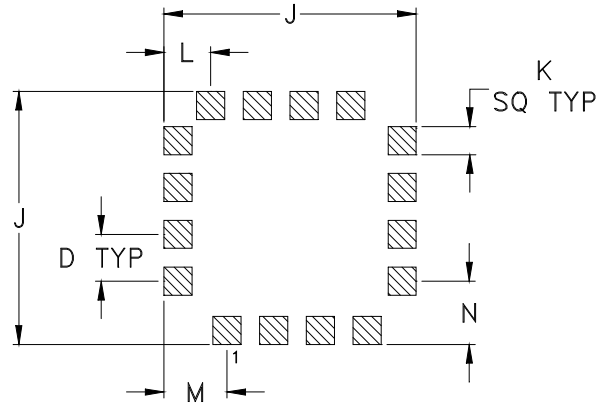
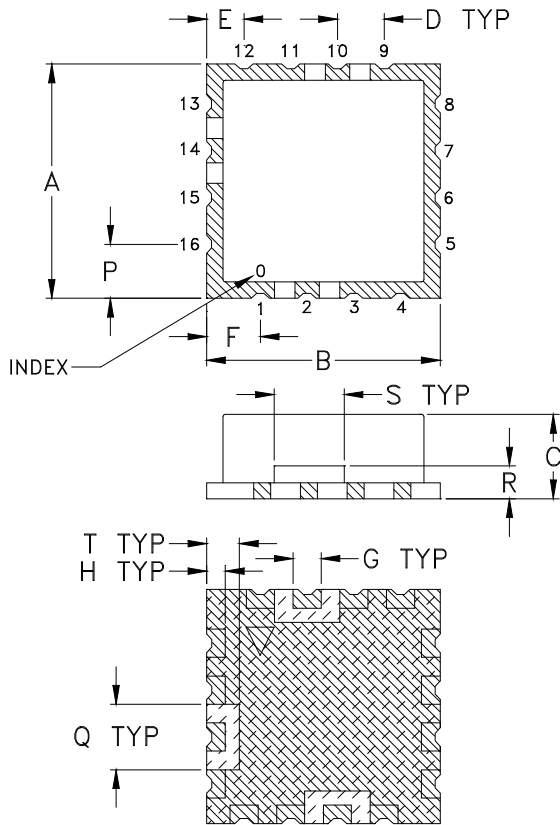

Suggested Layout,
Tolerance to be within $\pm .002$

CASE #	A	B	C	D	E	F	G	H	J	K
CK605	.500 (12.70)	.500 (12.70)	.180 (4.57)	.100 (2.54)	.080 (2.03)	.115 (2.92)	.060 (1.52)	.040 (1.02)	.540 (13.72)	.060 (1.52)

CASE #	L	M	N	P	Q	R	S	T	WT. GRAM
CK605	.100 (2.54)	.135 (3.43)	.135 (3.43)	.115 (2.92)	.140 (3.56)	.070 (1.78)	.150 (3.81)	.070 (1.78)	1.2 +0.5 -0.0

Dimensions are in inches (mm). Tolerances: 2 Pl. $\pm .03$; 3Pl. $\pm .015$

Notes:

- Case material: Nickel-Silver alloy.
- Base: Printed wiring laminate.
- Termination finish:
For RoHS Case Styles: 3-5 μ inch (.08-.13 microns) Gold over 120-240 μ inch (3.05-6.10 microns) Nickel plate.
All models, (+) suffix.



P.O. Box 350166, Brooklyn, New York 11235-0003 (718) 934-4500 Fax (718) 332-4661 For detailed performance specs & shopping online see Mini-Circuits web site



The Design Engineers Search Engine Provides ACTUAL Data Instantly From MINI-CIRCUITS At: www.minicircuits.com

RF/IF MICROWAVE COMPONENTS

Tape & Reel Packaging TR-F37



Tape Width, mm	Device Cavity Pitch, mm	Reel Size, inches	Devices per Reel	
24	16	7	Small quantity standards (see note)	10
				20
				50
				100
		13	Standard	200
500				

Note: Please consult individual model data sheet to determine device per reel availability.

Mini-Circuits carrier tape materials provide protection from ESD (Electro-Static Discharge) during handling and transportation. Tapes are static dissipative and comply with industry standards EIA-481/EIA-541.

Go to: www.minicircuits.com/pages/pdfs/tape.pdf



INTERNET <http://www.minicircuits.com>

P.O. Box 350166, Brooklyn, New York 11235-0003 (718) 934-4500 Fax (718) 332-4661

Distribution Centers NORTH AMERICA 800-654-7949 • 417-335-5935 • Fax 417-335-5945 • EUROPE 44-1252-832600 • Fax 44-1252-837010

Mini-Circuits ISO 9001 & ISO 14001 Certified

THIRD ANGLE PROJECTION



REVISIONS

REV	ECN No.	DESCRIPTION	DATE	DR	AUTH
E	M105563	ADDED "r1" PIN CONNECTION	06/02/06	MMG	DJ
F	M105640	CORRECTED NOTE 2	06/08/06	MMG	MM
G	M124395	ADDED "RAMP"	09/09	EM	HH
G	R77589	ADDED "RAMP"	09/09	EM	HH

SUGGESTED MOUNTING CONFIGURATION FOR CK605 CASE STYLE, "kg/rl/16AM01" PIN CONNECTION



NOTES:

1. TRACE WIDTH IS SHOWN FOR FR4 WITH DIELECTRIC THICKNESS .030" ± .002"; COPPER: 1/2 OZ. EACH SIDE. FOR OTHER MATERIALS TRACE WIDTH MAY NEED TO BE MODIFIED.
2. BOTTOM SIDE OF THE BOTTOM IS CONTINUOUS GROUND PLANE.

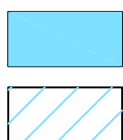

DENOTES PCB COPPER LAYOUT WITH SMOBC (SOLDER MASK OVER BARE COPPER)

DENOTES COPPER LAND PATTERN FREE OF SOLDER MASK

UNLESS OTHERWISE SPECIFIED	INITIALS	DATE
DIMENSIONS ARE IN INCHES	AV	08/07/00
TOLERANCES ON:	SK	08/08/00
2 PL DECIMALS ±	DB	08/08/00
3 PL DECIMALS ± .005		
ANGLES ±		
FRACTIONS ±		

 **Mini-Circuits®** 13 Neptune Avenue
Brooklyn NY 11235

PL,kg/rl/16AM01,CK605,ROS/LAVI/RAMP

SIZE	CODE IDENT	DRAWING NO:	REV:
A	15542	98-PL-012	G
FILE:	98PL012	SCALE: 5:1	SHEET: 1 OF 1

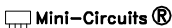
 Mini-Circuits®
THIS DOCUMENT AND ITS CONTENTS ARE THE PROPERTY OF MINI-CIRCUITS. EXCEPT FOR USE EXPRESSLY GRANTED, IN WRITING, TO ITS VENDORS, VENDEE AND THE UNITED STATES GOVERNMENT, MINI-CIRCUITS RESERVES ALL PROPRIETARY DESIGN, USE, MANUFACTURING AND REPRODUCTION RIGHTS THERETO. THESE CONTENTS SHALL NOT BE USED, DUPLICATED OR DISCLOSED TO ANY OUTSIDE PARTY, IN WHOLE OR IN PART, WITHOUT WRITTEN PERMISSION OF MINI-CIRCUITS.

Evaluation Board and Circuit



Schematic Diagram

Notes:

1. SMA Female connectors.
2. PCB Material: Rogers R04350 or equivalent, Dielectric Constant=3.5, Thickness=.030 inch.

 **Mini-Circuits®**

All Mini-Circuits products are manufactured under exacting quality assurance and control standards, and are capable of meeting published specifications after being subjected to any or all of the following physical and environmental test.

Specification	Test/Inspection Condition	Reference/Spec
Operating Temperature	-55° to 85°C Ambient Environment	Individual Model Data Sheet
Storage Temperature	-55° to 100° C Ambient Environment	Individual Model Data Sheet
HAST	130°C, 85% RH, 96 hours	JESD22-A110
Humidity	90 to 95% RH, 240 hours, 50°C	MIL-STD-202, Method 103, Condition A, Except 50°C and end-point electrical test done within 12 hours
Thermal Shock	-55° to 100°C, 100 cycles	MIL-STD-202, Method 107, Condition A-3, except +100°C
Solder Reflow Heat	Sn-Pb Eutectic Process: 225°C peak Pb-Free Process, 245°C peak	J-STD-020, Table 4-1, 4-2 and 5-2, Figure 5-1
Solderability	10X Magnification	J-STD-002, Para 4.2.5, Test S, 95% Coverage
Vibration (High Frequency)	20g peak, 20-2000 Hz, 4 times in each of three axes (total 12)	MIL-STD-883, Method 2007.3, Condition A
Mechanical Shock	50g, 11 ms, 1/2-sine, 18 shocks: 3 each direction, each of 3 axes	MIL-STD-202, Method 213, Condition A
Marking Resistance to Solvents	Isopropyl alcohol + mineral spirits at 25°C; terpene defluxer at 25°C; distilled water + proylene glycol monomethyl ether + monoethanolamine at 63°C to 70°C	MIL-STD-202, Method 215