

High Pass Filter

RHP-290+

50Ω 430 to 3100 MHz

Maximum Ratings

Operating Temperature	-40°C to 85°C
Storage Temperature	-55°C to 100°C
RF Power Input	0.5W at 25°C

Permanent damage may occur if any of these limits are exceeded.

Pin Connections

INPUT	2
OUTPUT	6
GROUND	1, 3, 4, 5, 7, 8

Outline Drawing

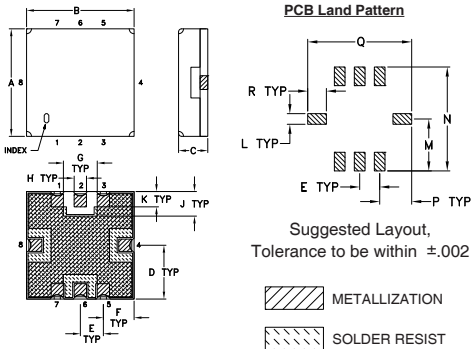

Outline Dimensions (inch/mm)

A	B	C	D	E	F	G	H	J
.350	.350	.100	.175	.075	.100	.110	.040	.080
8.89	8.89	2.54	4.45	1.91	2.54	2.79	1.02	2.03
K	L	M	N	P	Q	R	wt.	
.050	.040	.195	.390	.120	.390	.070	grams	
1.27	1.02	4.95	9.91	3.05	9.91	1.78		0.25

Note: Please refer to case style drawing for details

Demo Board MCL P/N: TB-332 Suggested PCB Layout (PL-176)

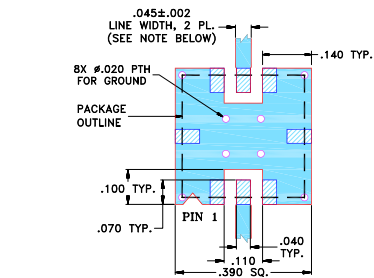

- NOTES:**
- TRACE WIDTH IS SHOWN FOR FR4 WITH DIELECTRIC THICKNESS .025" ± .002"; COPPER: 1/2 OZ. EACH SIDE. FOR OTHER MATERIALS TRACE WIDTH MAY NEED TO BE MODIFIED.
 - BOTTOM SIDE OF THE PCB IS CONTINUOUS GROUND PLANE.
- DENOTES PCB COPPER LAYOUT WITH SMOBC (SOLDER MASK OVER BARE COPPER)
- DENOTES COPPER LAND PATTERN FREE OF SOLDER MASK

Features

- low insertion loss, 0.5dB typ. @ passband
- high rejection
- shielded case
- aqueous washable

Applications

- transmitters / receivers
- sub-harmonic rejection
- military communications



Generic photo used for illustration purposes only
CASE STYLE: GP731

+RoHS Compliant

The +Suffix identifies RoHS Compliance. See our web site for RoHS Compliance methodologies and qualifications

Available Tape and Reel at no extra cost	
Reel Size	Devices/Reel
7"	10, 20, 50, 100, 200
13"	500, 1000

High Pass Filter Electrical Specifications (T_{AMB} = 25°C)

STOPBAND (MHz)	f _{co} , MHz Nom.	PASSBAND (MHz)	VSWR (:1)
(Loss > 40dB)	(Loss > 20dB)	(Loss < 3dB)	Stopband Typ. Passband Typ.
DC - 150	DC - 210	290	18 1.2

Typical Frequency Response

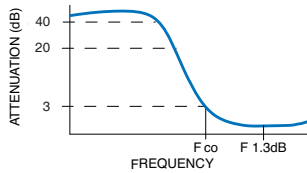

Functional Schematic

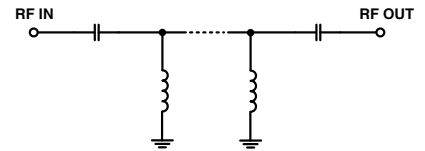

Typical Performance Data at 25°C

Frequency (MHz)	Insertion Loss (dB)	VSWR (:1)
1.0	85.37	5876.82
50.0	78.66	1241.46
100.0	64.96	410.67
150.0	48.30	115.31
189.0	34.78	62.07
210.0	27.64	48.88
225.0	22.62	36.16
262.5	10.36	12.93
270.0	8.40	7.37
290.0	3.31	3.38
300.0	1.97	2.15
325.0	0.88	1.15
430.0	0.49	1.08
500.0	0.43	1.14
750.0	0.40	1.33
1000.0	0.35	1.28
2000.0	0.33	1.09
3100.0	0.46	1.15

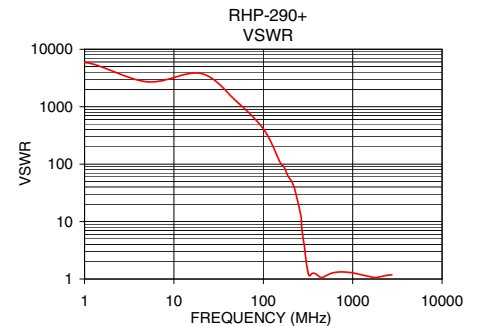
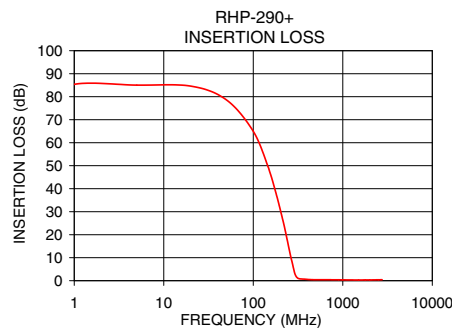

Notes

- Performance and quality attributes and conditions not expressly stated in this specification document are intended to be excluded and do not form a part of this specification document.
- Electrical specifications and performance data contained in this specification document are based on Mini-Circuit's applicable established test performance criteria and measurement instructions.
- The parts covered by this specification document are subject to Mini-Circuit's standard limited warranty and terms and conditions (collectively, "Standard Terms"); Purchasers of this part are entitled to the rights and benefits contained therein. For a full statement of the Standard Terms and the exclusive rights and remedies thereunder, please visit Mini-Circuit's website at www.minicircuits.com/MCLStore/terms.jsp



Metal Shield High Pass Filter

RHP-290+

Typical Performance Data

FREQ. (MHz)	INSERTION LOSS (dB)			INPUT RETURN LOSS (dB)			OUTPUT RETURN LOSS (dB)		
	@ -40° C	@ +25° C	@ +85° C	@ -40° C	@ +25° C	@ +85° C	@ -40° C	@ +25° C	@ +85° C
0.5	94.94	96.97	88.20	0.01	0.01	0.01	0.001	0.0002	0.001
1	95.06	96.71	89.34	0.01	0.01	0.01	0.001	0.0002	0.001
50	101.09	101.78	94.98	0.01	0.02	0.03	0.001	0.02	0.04
100	72.35	71.56	71.09	0.04	0.06	0.08	0.03	0.06	0.09
150	50.24	50.16	50.12	0.11	0.14	0.17	0.10	0.15	0.18
210	27.94	27.88	27.78	0.28	0.33	0.37	0.27	0.35	0.41
225	22.80	22.73	22.62	0.37	0.43	0.48	0.37	0.46	0.52
270	8.14	8.08	7.97	1.66	1.85	2.02	1.72	1.96	2.16
290	3.34	3.37	3.36	4.79	5.18	5.55	4.96	5.42	5.87
300	1.95	2.03	2.07	7.87	8.39	8.91	8.15	8.79	9.42
325	0.73	0.86	0.96	20.86	21.46	22.01	22.91	24.37	25.83
400	0.39	0.50	0.58	25.57	27.01	28.71	25.87	27.36	29.20
430	0.33	0.44	0.52	35.29	34.75	31.99	43.56	45.65	36.15
500	0.29	0.40	0.48	21.97	20.91	19.91	22.09	21.15	20.21
600	0.27	0.38	0.46	17.88	17.49	17.14	17.74	17.42	17.11
750	0.25	0.36	0.43	17.16	17.53	17.89	17.01	17.38	17.70
900	0.22	0.33	0.40	17.97	19.08	20.36	17.79	18.82	19.96
1000	0.21	0.32	0.40	18.62	20.44	22.65	18.52	20.25	22.20
1100	0.19	0.31	0.40	19.46	22.01	25.34	19.36	21.77	24.67
1500	0.16	0.33	0.45	24.87	31.00	30.54	24.98	32.10	32.64
1800	0.16	0.37	0.52	29.94	31.73	25.90	31.02	37.72	27.20
2000	0.17	0.39	0.55	35.36	29.54	25.01	42.09	32.57	26.40
2100	0.17	0.40	0.57	35.44	28.92	25.00	45.77	31.45	26.19
2500	0.19	0.46	0.66	32.01	28.78	27.02	33.31	30.51	27.82
2800	0.21	0.51	0.73	30.56	29.01	29.32	31.25	29.93	28.59
3000	0.23	0.54	0.77	29.42	28.39	29.41	29.30	28.20	27.18
3100	0.23	0.55	0.80	26.74	27.74	29.42	26.09	27.06	26.62
3200	0.24	0.57	0.83	25.84	27.11	28.42	24.81	25.85	25.30
3500	0.27	0.63	0.91	25.46	25.12	25.73	23.99	23.67	22.99
3800	0.31	0.70	1.01	22.95	23.14	23.17	21.73	22.53	21.92
4000	0.35	0.76	1.08	21.79	21.85	21.82	21.08	21.61	21.57
4100	0.37	0.79	1.12	20.99	21.13	21.19	20.51	21.12	21.33
4200	0.40	0.84	1.17	20.70	20.23	20.16	20.65	20.69	20.54
4500	0.93	1.38	1.75	21.66	21.09	20.58	16.82	17.85	18.63
4800	0.51	1.01	1.42	18.24	17.93	17.33	18.61	18.56	18.31
5000	0.54	1.06	1.50	17.87	16.75	16.25	17.99	17.26	16.90
5100	0.56	1.10	1.53	16.88	16.41	15.85	16.79	16.77	16.69
5200	0.61	1.17	1.61	16.52	16.05	15.60	16.28	16.34	16.25
5500	0.64	1.23	1.71	16.13	15.52	14.94	15.84	15.76	15.18
5800	0.70	1.32	1.89	16.95	16.31	15.20	16.96	16.40	15.18
6000	0.78	1.41	1.94	16.98	16.64	15.71	16.45	16.40	15.75
6100	0.82	1.58	1.98	17.23	16.92	16.26	16.85	16.92	16.23
6200	0.83	1.53	2.08	17.43	16.62	16.40	17.06	16.81	16.22
6500	1.13	1.87	2.42	16.58	17.36	17.78	16.31	17.31	17.51
6800	3.31	4.05	4.68	20.03	19.93	20.18	14.63	15.76	17.08
7000	4.51	5.23	5.83	11.11	11.60	12.33	11.73	13.25	14.54
7100	4.93	5.55	6.08	11.06	11.31	12.14	11.31	11.95	12.83
7200	3.74	4.49	5.09	11.87	11.99	12.29	12.01	12.29	12.77
7500	1.59	2.47	3.14	15.04	15.01	15.02	14.30	14.25	13.84
7800	1.40	2.31	3.16	15.18	15.27	15.09	13.84	14.25	13.74
8000	1.58	2.49	3.27	13.70	14.38	14.32	12.41	12.77	12.76
8100	1.57	2.54	3.35	13.25	13.73	14.37	11.93	11.97	12.30
8200	1.72	2.66	3.65	12.81	13.38	13.57	11.32	11.86	11.76
8500	2.19	2.96	3.74	12.39	12.69	12.95	10.21	10.50	10.93

REV. X2
RHP-290+
100901
Page 1 of 2



IF/RF MICROWAVE COMPONENTS • ISO 9001 ISO 14001 AS 9100 CERTIFIED • RoHS compliant
P.O. Box 350166, Brooklyn, New York 11235-0003 (718) 934-4500 Fax (718) 332-4661



The Design Engineers Search Engine finds the model you need, Instantly • For detailed performance specs & shopping online see



Metal Shield High Pass Filter

RHP-290+

Typical Performance Data

FREQ. (MHz)	GROUP DELAY (nsec)		
	@ -40° C	@ +25° C	@ +85° C
430	2.11	2.10	2.09
440	2.00	1.99	1.98
450	1.90	1.89	1.88
500	1.53	1.51	1.51
600	1.10	1.09	1.09
700	0.88	0.87	0.86
750	0.80	0.79	0.79
800	0.74	0.73	0.73
900	0.65	0.64	0.64
1000	0.59	0.58	0.58
1200	0.51	0.51	0.50
1400	0.47	0.46	0.46
1500	0.45	0.44	0.44
1700	0.43	0.42	0.41
1800	0.42	0.41	0.41
2000	0.40	0.39	0.39
2200	0.39	0.38	0.38
2400	0.38	0.37	0.37
2500	0.38	0.37	0.37
2700	0.38	0.37	0.36
2800	0.38	0.37	0.36
3000	0.37	0.36	0.36
3100	0.37	0.36	0.36
3200	0.37	0.36	0.36
3400	0.37	0.36	0.36
3500	0.37	0.36	0.36
3700	0.37	0.36	0.35
3800	0.37	0.36	0.35
4000	0.37	0.35	0.35
4200	0.37	0.36	0.36
4400	0.36	0.35	0.34
4500	0.30	0.28	0.29
4700	0.37	0.37	0.36
4800	0.37	0.36	0.36
5000	0.37	0.36	0.36
5200	0.37	0.36	0.35
5400	0.36	0.36	0.36
5500	0.37	0.36	0.35
5700	0.37	0.35	0.36
5800	0.38	0.36	0.36
6000	0.38	0.36	0.37
6200	0.39	0.39	0.37
6400	0.40	0.39	0.40
6500	0.43	0.40	0.41
6700	0.43	0.41	0.39
7000	0.18	0.19	0.19
7200	0.25	0.24	0.25
7400	0.45	0.43	0.43
7500	0.44	0.42	0.43
7700	0.40	0.40	0.41
8000	0.41	0.39	0.37
8200	0.40	0.39	0.37
8400	0.44	0.39	0.38
8500	0.38	0.41	0.17

REV. X2
RHP-290+
100901
Page 2 of 2



IF/RF MICROWAVE COMPONENTS • ISO 9001 ISO 14001 AS 9100 CERTIFIED RoHS compliant
P.O. Box 350166, Brooklyn, New York 11235-0003 (718) 934-4500 Fax (718) 332-4661



The Design Engineers Search Engine finds the model you need, Instantly • For detailed performance specs & shopping online see



Typical Performance Curves

INSERTION LOSS vs. TEMPERATURE

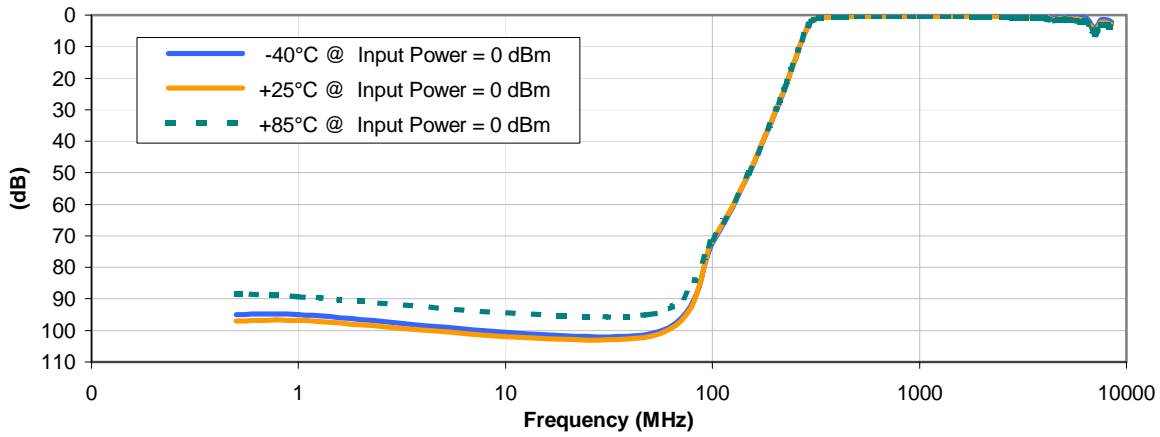

INPUT RETURN LOSS vs. TEMPERATURE

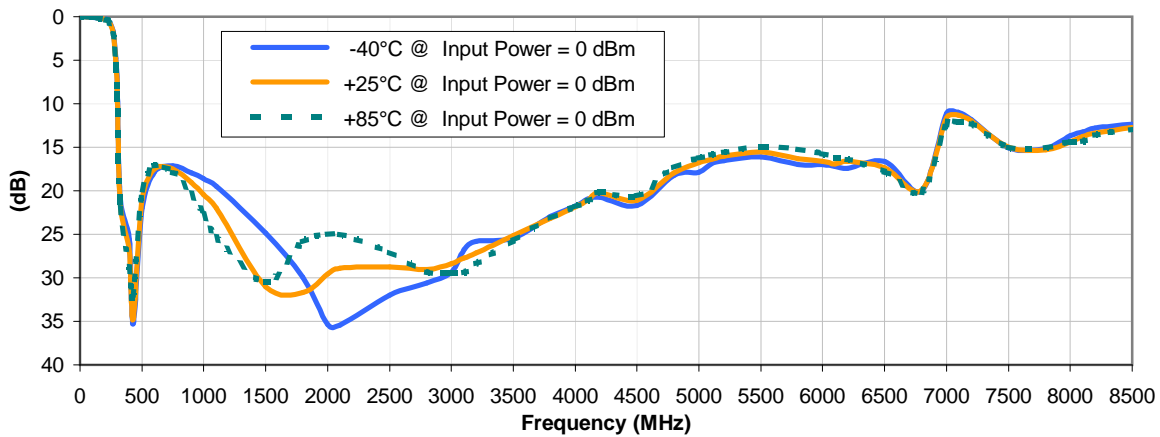

OUTPUT RETURN LOSS vs. TEMPERATURE

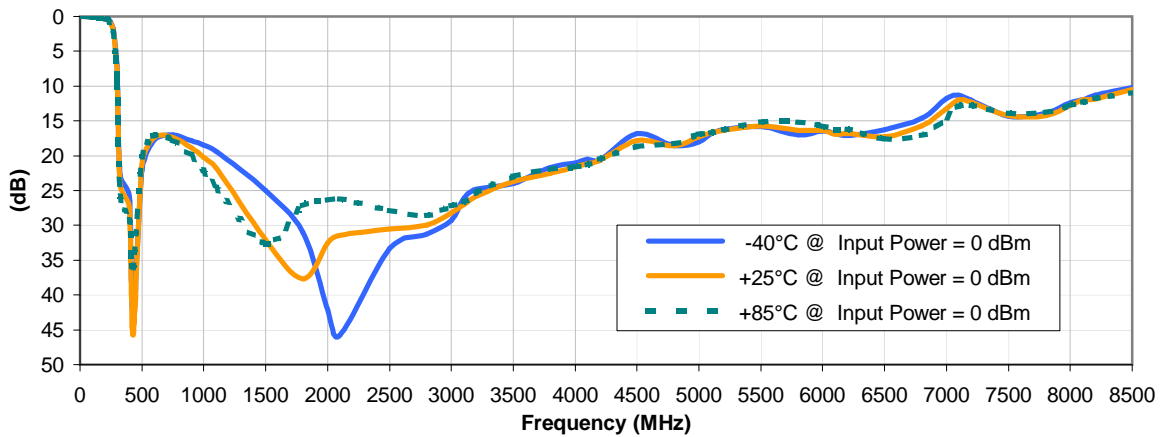

Typical Performance Curves

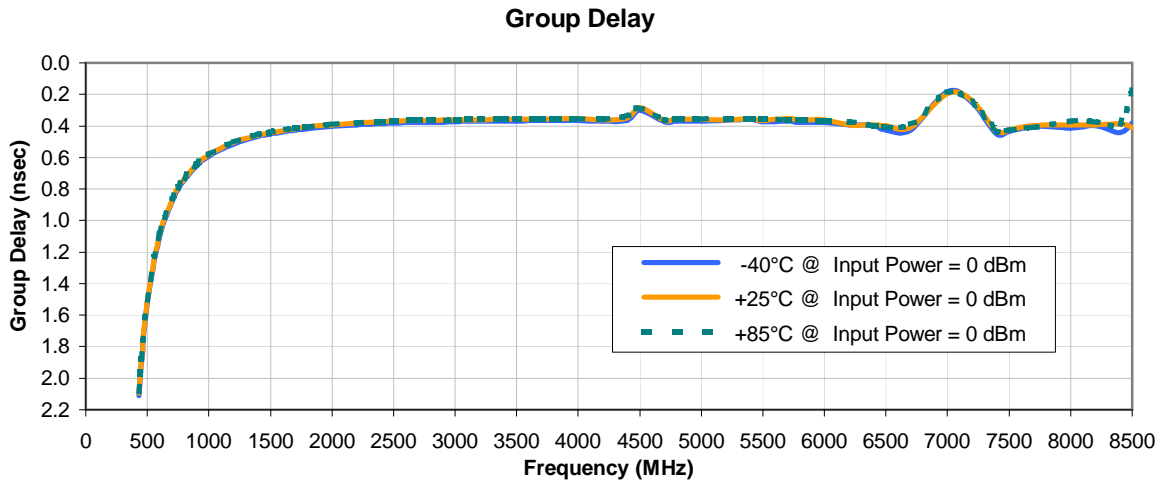

Outline Dimensions

GP731

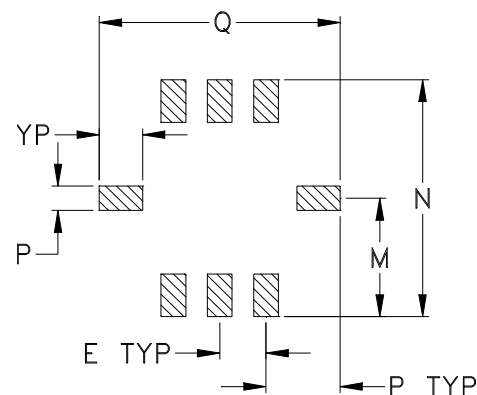
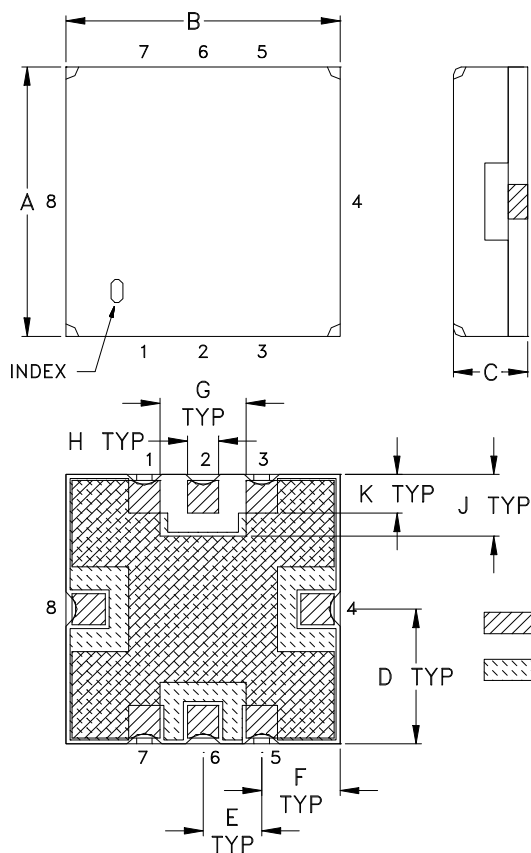

CASE #	A	B	C	D	E	F	G	H	J	K	L	M
GP731	.350 (8.89)	.350 (8.89)	.100 (2.54)	.175 (4.45)	.075 (1.91)	.100 (2.54)	.110 (2.79)	.040 (1.02)	.080 (2.03)	.050 (1.27)	.040 (1.02)	.195 (4.95)

CASE #	N	P	Q	R	WT. GRAM
GP731	.390 (9.91)	.120 (3.05)	.390 (9.91)	.070 (1.78)	.4 +0.3 -0.0

Dimensions are in inches (mm). Tolerances: 2 Pl. $\pm .03$; 3Pl. $\pm .015$

Notes:

- Case material: Nickel-Silver alloy.
- Base: Printed wiring laminate.
- Termination finish:
 - For RoHS Case Styles: 3-5 μ inch (.08-.13 microns) Gold over 120-240 μ inch (3.05-6.10 microns) Nickel plate.
 - For RoHS-5 Case Styles: Tin-Lead plate.



P.O. Box 350166, Brooklyn, New York 11235-0003 (718) 934-4500 Fax (718) 332-4661 For detailed performance specs & shopping online see Mini-Circuits web site



The Design Engineers Search Engine Provides ACTUAL Data Instantly From MINI-CIRCUITS At: www.minicircuits.com

RF/IF MICROWAVE COMPONENTS

Tape & Reel Packaging TR-F78

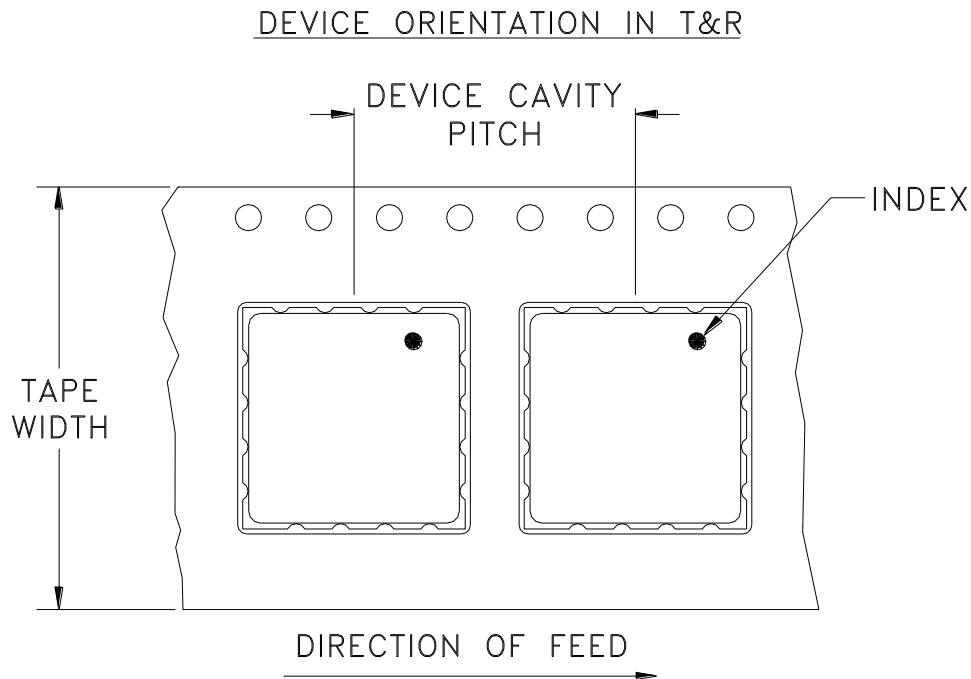

Tape Width, mm	Device Cavity Pitch, mm	Reel Size, inches	Devices per Reel see note
16	12	7	10
			20
			50
			100
			200
		13	500, 1000

Note: Please consult individual model data sheet to determine device per reel availability.

Mini-Circuits carrier tape materials provide protection from ESD (Electro-Static Discharge) during handling and transportation. Tapes are static dissipative and comply with industry standards EIA-481/EIA-541.

Go to: www.minicircuits.com/pages/pdfs/tape.pdf



INTERNET <http://www.minicircuits.com>

P.O. Box 350166, Brooklyn, New York 11235-0003 (718) 934-4500 Fax (718) 332-4661

Distribution Centers NORTH AMERICA 800-654-7949 • 417-335-5935 • Fax 417-335-5945 • EUROPE 44-1252-832600 • Fax 44-1252-837010

Mini-Circuits ISO 9001 & ISO 14001 Certified

THIRD ANGLE PROJECTION

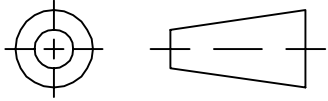

REVISIONS

REV	ECN No.	DESCRIPTION	DATE	DR	AUTH
OR	R59289	NEW RELEASE (FROM RAVON)	02/05	DK	HH
A	M101151	ADDED "RBP" & CORRECTED PIN CONNECTION TO DESCRIPTION OF PL-DWG.	10/10/05	MMG	DJ
B	M102713	UPDATED NOTES, ADDED "...WITH SMOBC"	01/20/06	GT	IL

**SUGGESTED MOUNTING CONFIGURATION
FOR GP731 CASE STYLE, "qf" PIN CONNECTION.**

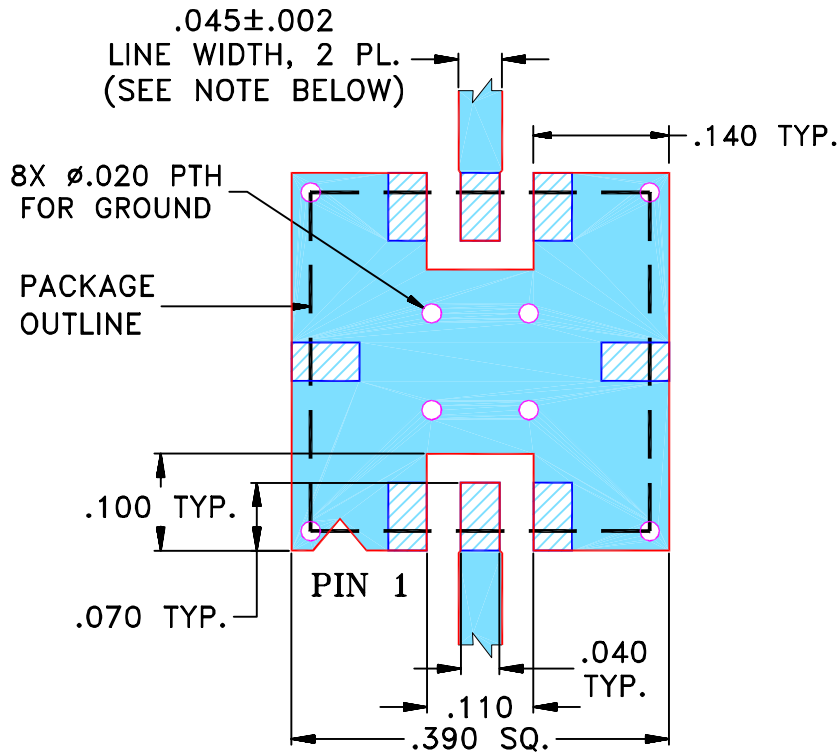

- NOTES:**
- TRACE WIDTH IS SHOWN FOR FR4 WITH DIELECTRIC THICKNESS .025" ± .002"; COPPER: 1/2 OZ. EACH SIDE. FOR OTHER MATERIALS TRACE WIDTH MAY NEED TO BE MODIFIED.
 - BOTTOM SIDE OF THE PCB IS CONTINUOUS GROUND PLANE.



DENOTES PCB COPPER LAYOUT WITH SMOBC (SOLDER MASK OVER BARE COPPER)



DENOTES COPPER LAND PATTERN FREE OF SOLDER MASK

UNLESS OTHERWISE SPECIFIED	INITIALS	DATE
DIMENSIONS ARE IN INCHES	DRAWN DK (RAVON)	10 FEB 05
TOLERANCES ON:	CHECKED RZ (RAVON)	10 FEB 05
2 PL DECIMALS ±	APPROVED HH (RAVON)	10 FEB 05
3 PL DECIMALS ± .005		
ANGLES ±		
FRACTIONS ±		



Mini-Circuits®

13 Neptune Avenue
Brooklyn NY 11235

PL, qf, GP731, RBP, TB-332

Mini-Circuits®
THIS DOCUMENT AND ITS CONTENTS ARE THE PROPERTY OF MINI-CIRCUITS. EXCEPT FOR USE EXPRESSLY GRANTED, IN WRITING, TO ITS VENDORS, VENDEE AND THE UNITED STATES GOVERNMENT, MINI-CIRCUITS RESERVES ALL PROPRIETARY DESIGN, USE, MANUFACTURING AND REPRODUCTION RIGHTS THERETO. THESE CONTENTS SHALL NOT BE USED, DUPLICATED OR DISCLOSED TO ANY OUTSIDE PARTY, IN WHOLE OR IN PART, WITHOUT WRITTEN PERMISSION OF MINI-CIRCUITS.

ASHEETA1.DWG REV:A DATE:01/12/95

SIZE	CODE IDENT	DRAWING NO:	REV:
A	15542	98-PL-176	B
FILE:	98PL176	SCALE: 5:1	SHEET: 1 OF 1

Evaluation Board and Circuit

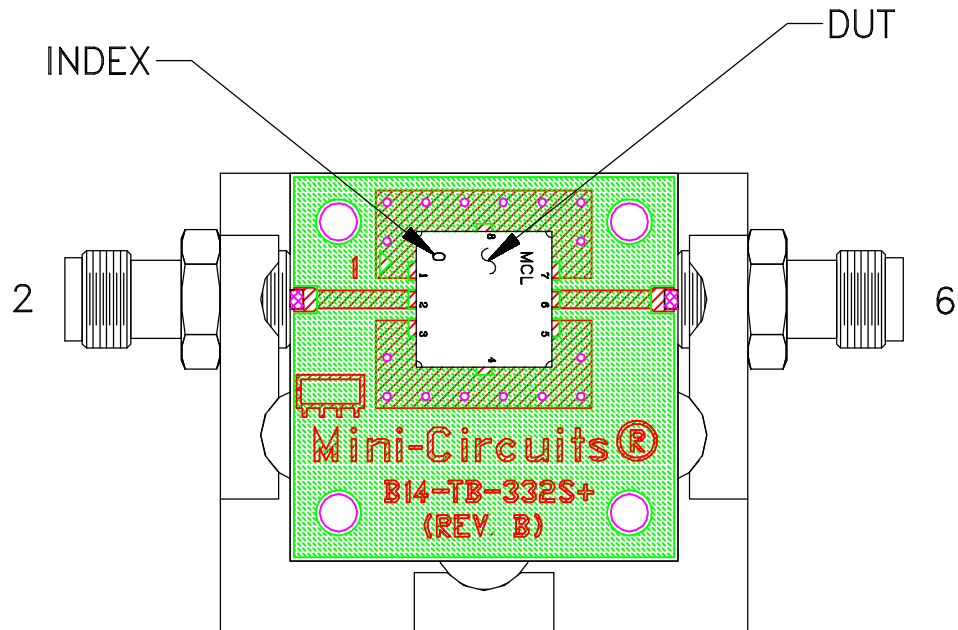

TB-332

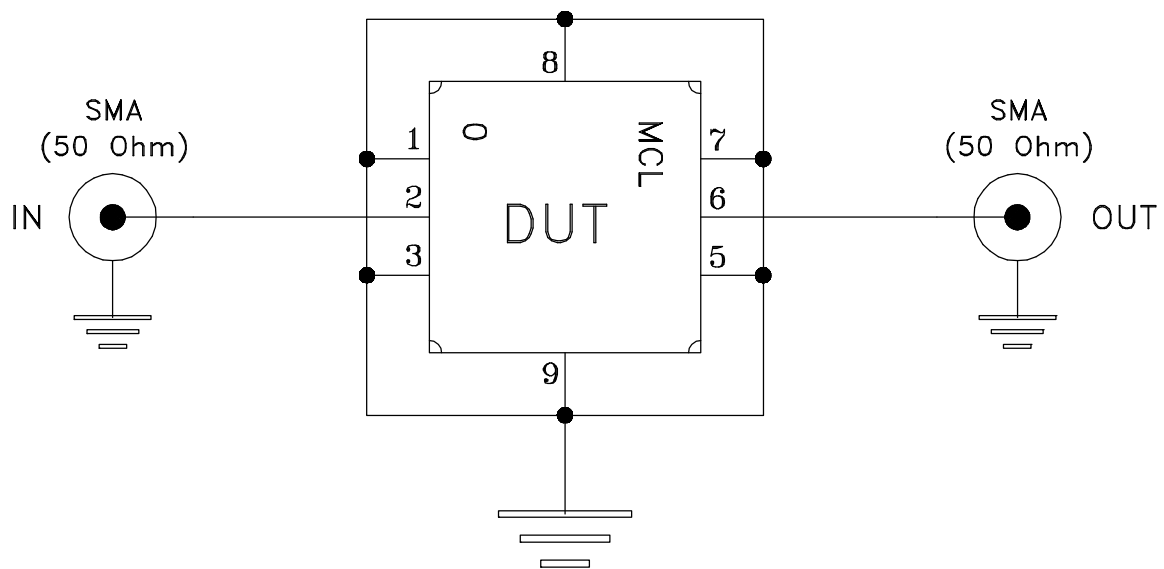

Schematic Diagram

Notes:

1. 50 Ohm SMA Female connectors.
2. PCB Material: R04350 or equivalent,
Dielectric Constant=3.5, Thickness=.020 inch.

 **Mini-Circuits®**

All Mini-Circuits products are manufactured under exacting quality assurance and control standards, and are capable of meeting published specifications after being subjected to any or all of the following physical and environmental test.

Specification	Test/Inspection Condition	Reference/Spec
Operating Temperature	-40° to 85° C Ambient Environment	Individual Model Data Sheet
Storage Temperature	-55° to 100° C Ambient Environment	Individual Model Data Sheet
HAST	130°C, 85% RH, 96 hours	JESD22-A110
Humidity	90 to 95% RH, 240 hours, 50°C	MIL-STD-202, Method 103, Condition A, Except 50°C and end-point electrical test done within 12 hours
Thermal Shock	-55° to 100°C, 100 cycles	MIL-STD-202, Method 107, Condition A-3, except +100°C
Solder Reflow Heat	Sn-Pb Eutectic Process: 225°C peak Pb-Free Process, 245°C peak	J-STD-020, Table 4-1, 4-2 and 5-2, Figure 5-1
Solderability	10X Magnification	J-STD-002, Para 4.2.5, Test S, 95% Coverage
Vibration (High Frequency)	20g peak, 20-2000 Hz, 4 times in each of three axes (total 12)	MIL-STD-883, Method 2007.3, Condition A
Mechanical Shock	50g, 11 ms, 1/2-sine, 18 shocks: 3 each direction, each of 3 axes	MIL-STD-202, Method 213, Condition A
Marking Resistance to Solvents	Isopropyl alcohol + mineral spirits at 25°C; terpene defluxer at 25°C; distilled water + proylene glycol monomethyl ether + monoethanolamine at 63°C to 70°C	MIL-STD-202, Method 215