

# Surface Mount Frequency Mixer

## RMS-30+

Level 7 (LO Power +7 dBm) 200 to 3000 MHz



Generic photo used for illustration purposes only

CASE STYLE: TT240

**+RoHS Compliant**

The +Suffix identifies RoHS Compliance. See our web site for RoHS Compliance methodologies and qualifications

### Maximum Ratings

Operating Temperature	-40°C to 85°C
Storage Temperature	-55°C to 100°C
RF Power	200mW
IF Current	40mA
Permanent damage may occur if any of these limits are exceeded.	

### Pin Connections

LO	1
RF	4
IF	5
GROUND	2,3,6

### Features

- wideband, 200-3000 MHz
- conversion loss, 7.0 dB typ.
- small size, 0.25"x0.31"x0.2"

### Applications

- MMDS
- ISM/PCS/UMTS
- GPS

### Outline Drawing

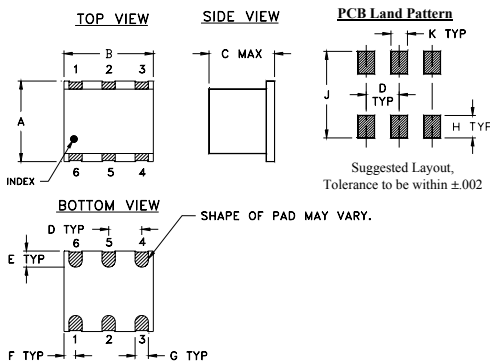

### Outline Dimensions (inch/mm)

A	B	C	D	E	F
.250	.31	.20	.100	.050	.055
6.35	7.87	5.08	2.54	1.27	1.40
G	H	J	K	wt	
.040	.070	.270	.050	grams	
1.02	1.78	6.86	1.27	0.50	

Demo Board MCL P/N: TB-03  
Suggested PCB Layout (PL-052)

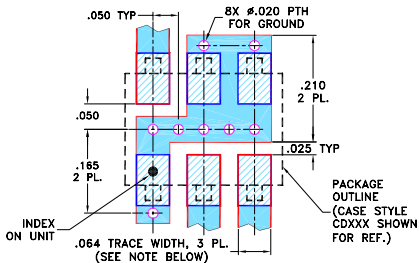

- NOTES:
1. TRACE WIDTH IS SHOWN FOR ROGERS RO4350B WITH DIELECTRIC THICKNESS .030" ± .002"; COPPER: 1/2 OZ. EACH SIDE. FOR OTHER MATERIALS TRACE WIDTH MAY NEED TO BE MODIFIED.
  2. BOTTOM SIDE OF THE PCB IS CONTINUOUS GROUND PLANE.

- DENOTES PCB COPPER LAYOUT WITH SMOBC (SOLDER MASK OVER BARE COPPER)
- DENOTES COPPER LAND PATTERN FREE OF SOLDER MASK

### Notes

- A. Performance and quality attributes and conditions not expressly stated in this specification document are intended to be excluded and do not form a part of this specification document.
- B. Electrical specifications and performance data contained in this specification document are based on Mini-Circuit's applicable established test performance criteria and measurement instructions.
- C. The parts covered by this specification document are subject to Mini-Circuit's standard limited warranty and terms and conditions (collectively, "Standard Terms"); Purchasers of this part are entitled to the rights and benefits contained therein. For a full statement of the Standard Terms and the exclusive rights and remedies thereunder, please visit Mini-Circuit's website at [www.minicircuits.com/MCLStore/terms.jsp](http://www.minicircuits.com/MCLStore/terms.jsp)

### Electrical Specifications

FREQUENCY (MHz)	CONVERSION LOSS (dB)	LO-RF ISOLATION (dB)		LO-IF ISOLATION (dB)		IP3 at center band (dBm)
		Typ.	Min.	Typ.	Min.	
200-3000	DC-1000	27	17	20	7	11

1 dB COMP: +1 dBm typ.  
m=mid band [2f<sub>L</sub> to f<sub>H</sub>/2]  
For phase detection, DC output positive with in-phase RF & LO.

### Typical Performance Data

Frequency (MHz)		Conversion Loss (dB)	Isolation L-R (dB)	Isolation L-I (dB)	VSWR RF Port (:1)	VSWR LO Port (:1)
RF	LO	LO +7 dBm	LO +7 dBm	LO +7 dBm	LO +7 dBm	LO +7 dBm
200.10	230.10	5.30	35.34	22.95	1.59	6.06
400.10	430.10	4.94	45.55	22.74	1.63	3.34
600.09	630.09	4.68	38.09	24.23	1.75	2.59
828.65	858.65	6.27	32.57	30.75	1.81	2.05
1000.07	1030.07	6.43	30.53	30.13	2.20	1.49
1114.35	1144.35	6.16	30.64	23.50	2.56	1.38
1228.63	1258.63	5.88	29.50	21.69	3.00	1.34
1342.92	1372.92	6.03	30.63	23.23	3.60	1.47
1457.20	1487.20	6.87	30.80	25.21	4.40	1.62
1500.00	1530.00	6.95	31.01	25.49	4.81	1.75
1685.76	1655.76	7.08	30.14	20.62	5.49	2.12
1857.18	1827.18	7.22	28.52	16.49	3.82	2.51
1971.47	1941.47	7.26	27.20	14.81	3.19	2.75
2085.75	2055.75	7.12	26.56	13.64	2.97	2.86
2200.03	2170.03	6.95	26.14	12.33	2.76	2.94
2371.45	2341.45	6.77	24.57	11.40	2.44	2.95
2542.87	2512.87	6.62	25.24	13.33	1.85	2.94
2714.30	2684.30	5.98	26.06	14.42	1.35	2.45
2885.72	2855.72	6.24	26.86	14.79	1.60	1.83
3000.00	2970.00	6.95	28.42	16.91	2.52	1.60

### Electrical Schematic

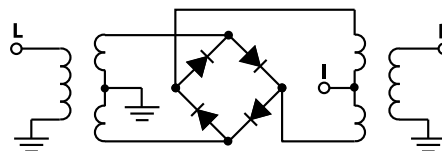

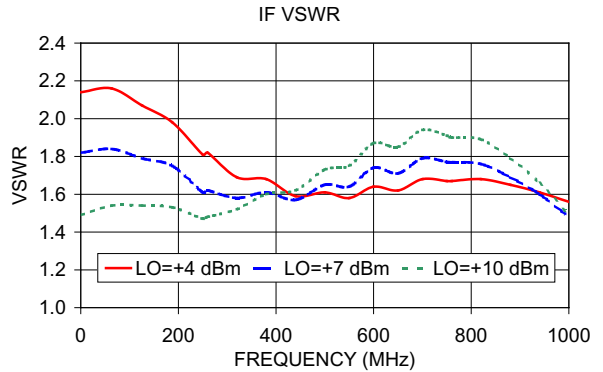
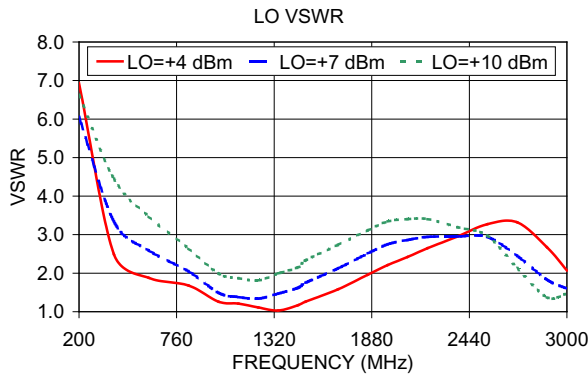
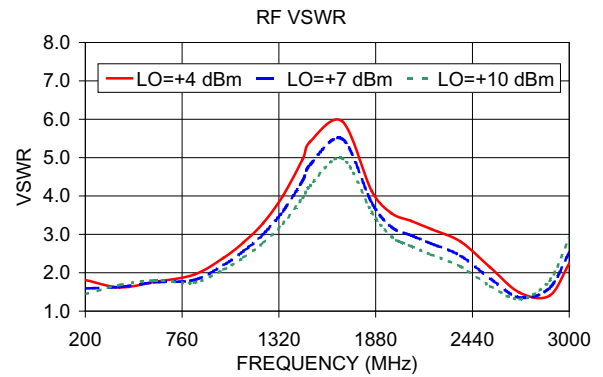
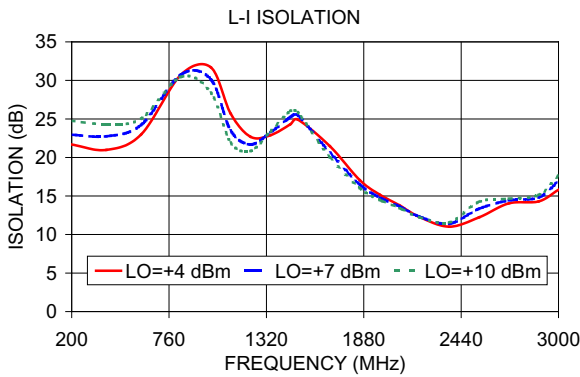
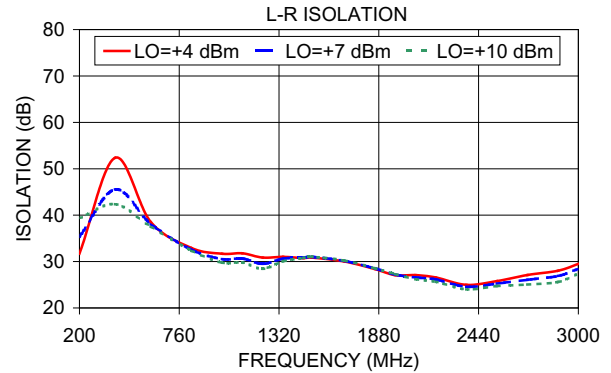
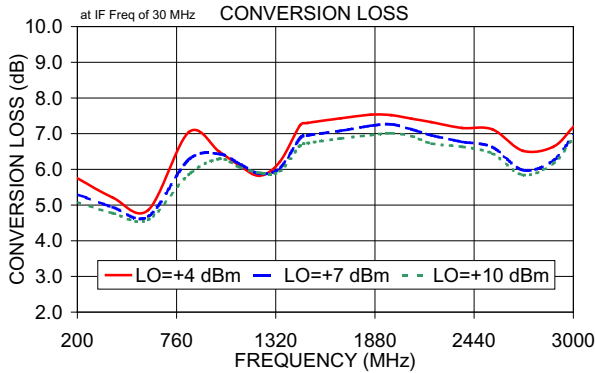

**Notes**

- A. Performance and quality attributes and conditions not expressly stated in this specification document are intended to be excluded and do not form a part of this specification document.
- B. Electrical specifications and performance data contained in this specification document are based on Mini-Circuit's applicable established test performance criteria and measurement instructions.
- C. The parts covered by this specification document are subject to Mini-Circuits standard limited warranty and terms and conditions (collectively, "Standard Terms"); Purchasers of this part are entitled to the rights and benefits contained therein. For a full statement of the Standard Terms and the exclusive rights and remedies thereunder, please visit Mini-Circuits' website at [www.minicircuits.com/MCLStore/terms.jsp](http://www.minicircuits.com/MCLStore/terms.jsp)



# Frequency Mixer

# RMS-30+

## Typical Performance Data

RF (IN) (MHz)	LO (MHz)	CONVERSION LOSS IF FIXED @IF(OUT)=30MHz (dB)			RF (IN) (MHz)	LO (MHz)	IP3 INPUT (dBm)			RF (IN) (MHz)	LO (MHz)	COMPRESSION @RF IN=+1dBm (dB)		
		@LO (dBm)					@LO (dBm)					@LO (dBm)		
		+4	+7	+10			+4	+7	+10			+4	+7	+10
80.0	110.0	16.04	10.72	8.78	80.0	110.0	-0.27	7.09	15.68	80.0	110.0	-3.25	-0.61	-0.06
160.0	190.0	7.15	6.35	6.03	160.0	190.0	12.09	15.00	16.77	160.0	190.0	1.54	1.04	0.77
240.0	270.0	5.92	5.53	5.28	240.0	270.0	14.92	15.74	15.00	240.0	270.0	1.96	1.57	1.35
320.0	350.0	5.73	5.33	5.06	320.0	350.0	12.54	13.45	13.26	320.0	350.0	2.03	1.69	1.47
400.0	430.0	5.59	5.22	4.97	400.0	430.0	10.46	10.76	11.51	400.0	430.0	1.99	1.68	1.46
480.0	510.0	5.39	5.18	5.04	480.0	510.0	17.30	14.42	13.28	480.0	510.0	1.82	1.46	1.19
560.0	590.0	5.25	5.05	4.95	560.0	590.0	10.22	13.13	17.88	560.0	590.0	1.90	1.55	1.25
640.0	670.0	5.18	4.89	4.72	640.0	670.0	8.49	10.84	13.26	640.0	670.0	2.85	2.42	2.10
720.0	750.0	6.24	5.52	5.11	720.0	750.0	8.75	12.68	14.71	720.0	750.0	2.70	2.49	2.24
800.0	830.0	7.22	6.37	5.84	800.0	830.0	5.49	7.10	8.54	800.0	830.0	1.82	1.86	1.77
880.0	910.0	7.56	6.94	6.51	880.0	910.0	5.02	6.40	7.90	880.0	910.0	1.21	1.16	1.11
960.0	990.0	7.12	6.78	6.57	960.0	990.0	6.11	6.91	7.85	960.0	990.0	1.22	0.96	0.79
1040.0	1070.0	6.67	6.42	6.31	1040.0	1070.0	8.59	9.33	9.95	1040.0	1070.0	1.15	0.90	0.72
1120.0	1150.0	6.54	6.33	6.25	1120.0	1150.0	10.28	11.00	11.83	1120.0	1150.0	0.76	0.56	0.45
1200.0	1230.0	6.34	6.14	6.08	1200.0	1230.0	15.64	13.40	14.07	1200.0	1230.0	0.58	0.36	0.25
1300.0	1330.0	6.52	6.22	6.07	1300.0	1330.0	12.78	14.77	19.03	1300.0	1330.0	0.92	0.65	0.45
1380.0	1410.0	7.08	6.63	6.41	1380.0	1410.0	14.28	17.06	20.18	1380.0	1410.0	0.99	0.79	0.63
1480.0	1510.0	7.67	7.16	6.88	1480.0	1510.0	15.97	16.76	17.33	1480.0	1510.0	0.78	0.66	0.54
1560.0	1590.0	7.72	7.19	6.88	1560.0	1590.0	12.21	13.33	14.34	1560.0	1590.0	0.83	0.71	0.58
1660.0	1690.0	7.85	7.30	7.01	1660.0	1690.0	10.91	11.66	12.57	1660.0	1690.0	0.79	0.68	0.58
1740.0	1770.0	7.77	7.27	6.97	1740.0	1770.0	10.09	10.76	11.50	1740.0	1770.0	0.80	0.68	0.58
1840.0	1870.0	7.73	7.24	6.93	1840.0	1870.0	9.44	10.04	10.83	1840.0	1870.0	0.91	0.76	0.63
1920.0	1950.0	7.72	7.20	6.90	1920.0	1950.0	8.84	9.39	10.11	1920.0	1950.0	0.93	0.78	0.67
2020.0	2050.0	7.54	7.07	6.82	2020.0	2050.0	8.28	8.65	9.14	2020.0	2050.0	1.06	0.89	0.78
2100.0	2130.0	7.51	6.99	6.74	2100.0	2130.0	7.72	8.21	8.72	2100.0	2130.0	0.96	0.82	0.73
2200.0	2230.0	7.40	6.80	6.52	2200.0	2230.0	6.63	7.20	8.02	2200.0	2230.0	1.12	0.95	0.84
2280.0	2310.0	7.43	6.82	6.53	2280.0	2310.0	6.22	6.96	7.86	2280.0	2310.0	1.12	0.91	0.76
2380.0	2410.0	7.35	6.69	6.37	2380.0	2410.0	5.56	7.01	8.59	2380.0	2410.0	1.36	1.09	0.89
2460.0	2490.0	7.33	6.56	6.16	2460.0	2490.0	4.95	7.34	9.31	2460.0	2490.0	1.50	1.19	1.04
2560.0	2590.0	7.14	6.33	5.95	2560.0	2590.0	4.49	6.86	9.05	2560.0	2590.0	1.66	1.25	1.15
2640.0	2670.0	7.12	6.25	5.91	2640.0	2670.0	3.81	5.94	7.74	2640.0	2670.0	1.69	1.27	1.14
2740.0	2770.0	7.05	6.25	5.95	2740.0	2770.0	4.10	6.11	8.21	2740.0	2770.0	1.53	1.12	0.99
2820.0	2850.0	7.21	6.43	6.15	2820.0	2850.0	4.92	6.85	9.19	2820.0	2850.0	1.40	0.99	0.82
2920.0	2950.0	7.47	6.80	6.54	2920.0	2950.0	7.50	8.78	10.44	2920.0	2950.0	1.18	0.80	0.65
3000.0	3030.0	7.76	7.22	7.01	3000.0	3030.0	9.85	10.34	11.23	3000.0	3030.0	0.99	0.68	0.53
3100.0	3130.0	8.26	7.78	7.57	3100.0	3130.0	11.08	10.44	11.79	3100.0	3130.0	0.81	0.55	0.43
3180.0	3210.0	8.80	8.37	8.15	3180.0	3210.0	14.91	14.24	14.69	3180.0	3210.0	0.70	0.47	0.36
3280.0	3310.0	9.59	9.18	8.94	3280.0	3310.0	14.65	15.89	15.49	3280.0	3310.0	0.60	0.37	0.29
3360.0	3390.0	10.13	9.74	9.50	3360.0	3390.0	13.66	16.00	16.09	3360.0	3390.0	0.58	0.35	0.26
3460.0	3490.0	10.97	10.56	10.33	3460.0	3490.0	13.27	15.97	17.47	3460.0	3490.0	0.59	0.30	0.21

## Typical Performance Data

IF (OUT) (MHz)	LO (MHz)	CONVERSION LOSS VS. IF FREQUENCY @RF(IN)=1510.1MHz (dB)
		@LO (dBm) +7
1270.1	240.0	10.32
1230.1	280.0	9.63
1190.1	320.0	9.39
1150.1	360.0	9.44
1110.1	400.0	9.20
1070.1	440.0	9.18
1030.1	480.0	9.09
990.1	520.0	8.97
950.1	560.0	8.74
910.1	600.0	8.30
870.1	640.0	7.95
850.1	660.0	7.84
810.1	700.0	7.53
790.1	720.0	7.35
750.1	760.0	7.04
730.1	780.0	6.99
690.1	820.0	6.91
670.1	840.0	6.88
630.1	880.0	6.79
610.1	900.0	6.78
570.1	940.0	6.79
550.1	960.0	6.79
510.1	1000.0	6.75
490.1	1020.0	6.69
450.1	1060.0	6.58
430.1	1080.0	6.64
390.1	1120.0	6.70
370.1	1140.0	6.75
330.1	1180.0	6.97
310.1	1200.0	6.99
270.1	1240.0	7.16
250.1	1260.0	7.25
210.1	1300.0	7.41
190.1	1320.0	7.46
150.1	1360.0	7.51
130.1	1380.0	7.50
90.1	1420.0	7.44
70.1	1440.0	7.45
30.1	1480.0	7.35
10.1	1500.0	7.55

IF (OUT) (MHz)	LO (MHz)	CONVERSION LOSS VS. IF FREQUENCY @RF(IN)=189.9MHz (dB)
		@LO (dBm) +7
10.1	200.0	5.88
50.1	240.0	5.76
90.1	280.0	5.69
130.1	320.0	5.63
170.1	360.0	5.67
210.1	400.0	5.69
250.1	440.0	5.65
290.1	480.0	5.56
330.1	520.0	5.43
370.1	560.0	5.17
410.1	600.0	4.99
450.1	640.0	4.91
490.1	680.0	4.96
530.1	720.0	5.06
570.1	760.0	5.27
610.1	800.0	5.55
650.1	840.0	5.79
690.1	880.0	5.98
730.1	920.0	6.04
770.1	960.0	5.99
810.1	1000.0	6.01
830.1	1020.0	6.01
870.1	1060.0	6.01
890.1	1080.0	6.00
930.1	1120.0	5.97
950.1	1140.0	5.95
990.1	1180.0	5.92
1010.1	1200.0	5.95
1050.1	1240.0	6.10
1070.1	1260.0	6.24
1110.1	1300.0	6.58
1130.1	1320.0	6.75
1170.1	1360.0	7.37
1190.1	1380.0	7.60
1230.1	1420.0	8.21
1250.1	1440.0	8.65
1290.1	1480.0	9.15
1310.1	1500.0	9.40
1350.1	1540.0	10.11
1370.1	1560.0	10.44

IF (OUT) (MHz)	LO (MHz)	CONVERSION LOSS VS. IF FREQUENCY @RF(IN)=3010.1MHz (dB)
		@LO (dBm) +7
1310.1	1700.0	10.40
1270.1	1740.0	9.88
1230.1	1780.0	9.50
1190.1	1820.0	9.19
1150.1	1860.0	8.82
1110.1	1900.0	8.35
1070.1	1940.0	7.95
1030.1	1980.0	7.66
990.1	2020.0	7.38
950.1	2060.0	7.22
910.1	2100.0	7.04
870.1	2140.0	6.93
830.1	2180.0	6.87
790.1	2220.0	6.86
750.1	2260.0	6.83
730.1	2280.0	6.83
690.1	2320.0	6.85
670.1	2340.0	6.84
630.1	2380.0	6.87
610.1	2400.0	6.87
570.1	2440.0	6.90
550.1	2460.0	6.94
510.1	2500.0	7.00
490.1	2520.0	7.00
450.1	2560.0	6.99
430.1	2580.0	6.98
390.1	2620.0	6.96
370.1	2640.0	6.95
330.1	2680.0	6.94
310.1	2700.0	6.92
270.1	2740.0	6.95
250.1	2760.0	6.97
210.1	2800.0	6.99
190.1	2820.0	7.02
150.1	2860.0	7.10
130.1	2880.0	7.08
90.1	2920.0	7.13
70.1	2940.0	7.18
30.1	2980.0	7.17
10.1	3000.0	7.42

## Typical Performance Data

LO (MHz)	LO-RF ISOLATION (dB)			LO-IF ISOLATION (dB)			RF (IN) (MHz)	LO (MHz)	RF-IF ISOLATION (dB)		
	@LO (dBm)			@LO (dBm)					@LO (dBm)		
	+4	+7	+10	+4	+7	+10			+4	+7	+10
110.0	29.56	30.92	32.92	38.92	33.85	32.50	80.0	110.0	39.36	36.46	34.13
190.0	30.56	33.84	36.93	28.38	28.71	30.47	160.0	190.0	30.07	29.81	29.37
270.0	35.60	39.59	43.80	26.42	27.82	29.93	240.0	270.0	28.40	28.28	28.11
350.0	43.82	51.04	66.32	25.90	27.58	29.73	320.0	350.0	28.89	28.64	28.15
430.0	46.27	46.76	44.98	25.59	27.49	29.74	400.0	430.0	32.81	33.15	33.10
510.0	39.77	40.41	39.82	25.41	27.48	29.76	480.0	510.0	37.96	39.07	39.11
590.0	38.50	39.64	39.46	25.61	27.73	29.96	560.0	590.0	34.71	34.33	33.69
670.0	37.38	38.59	38.72	25.76	27.90	30.10	640.0	670.0	33.57	33.41	33.07
750.0	35.21	36.42	36.58	26.16	28.28	30.42	720.0	750.0	36.14	36.89	37.02
830.0	33.30	34.23	34.45	26.26	28.41	30.64	800.0	830.0	38.24	39.03	39.76
910.0	32.10	32.22	31.98	27.68	30.11	32.47	880.0	910.0	32.60	32.19	32.56
990.0	32.71	32.35	31.62	29.51	32.11	34.53	960.0	990.0	27.23	26.41	26.29
1070.0	32.48	31.85	30.94	29.70	32.58	35.30	1040.0	1070.0	23.04	22.35	22.20
1150.0	32.16	31.06	30.04	31.68	35.07	37.90	1120.0	1150.0	20.14	19.46	19.32
1230.0	32.04	30.56	29.29	33.79	36.78	38.86	1200.0	1230.0	18.76	18.31	18.05
1330.0	31.81	30.74	29.84	36.02	37.97	39.06	1300.0	1330.0	20.15	20.03	20.04
1410.0	31.79	30.83	30.43	37.17	37.40	37.08	1380.0	1410.0	22.16	22.15	22.18
1510.0	31.38	30.57	30.27	36.34	34.65	33.37	1480.0	1510.0	24.82	24.97	25.21
1590.0	30.87	30.16	29.84	33.97	31.94	30.53	1560.0	1590.0	28.18	28.42	28.71
1690.0	30.27	29.47	29.42	30.75	28.91	27.80	1660.0	1690.0	32.85	32.80	32.90
1770.0	29.83	29.19	29.17	28.40	26.91	26.04	1740.0	1770.0	31.24	30.99	31.02
1870.0	29.33	28.85	28.75	26.11	24.89	23.91	1840.0	1870.0	27.14	27.05	27.14
1950.0	29.05	28.56	28.59	24.58	23.36	22.55	1920.0	1950.0	24.90	24.95	25.08
2050.0	28.78	28.20	28.18	22.83	21.64	20.85	2020.0	2050.0	22.80	22.91	23.07
2130.0	28.86	28.44	28.41	21.61	20.45	19.60	2100.0	2130.0	21.64	21.88	21.98
2230.0	28.63	28.40	28.43	20.45	18.99	17.88	2200.0	2230.0	20.61	20.86	21.01
2310.0	28.22	28.21	28.48	19.45	17.94	16.79	2280.0	2310.0	20.05	20.31	20.40
2410.0	27.65	27.43	27.50	19.11	17.31	15.87	2380.0	2410.0	19.71	19.70	19.69
2490.0	26.75	25.95	25.37	19.92	18.20	16.64	2460.0	2490.0	20.39	20.34	20.05
2590.0	26.22	24.83	23.70	22.67	21.51	19.97	2560.0	2590.0	24.92	25.71	26.32
2670.0	27.10	25.64	24.46	24.15	22.68	20.58	2640.0	2670.0	38.61	39.42	37.69
2770.0	29.07	28.01	27.06	22.78	20.47	18.27	2740.0	2770.0	26.07	24.37	23.86
2850.0	32.19	31.42	30.42	21.50	18.83	16.51	2820.0	2850.0	22.99	22.30	22.23
2950.0	38.71	37.81	36.09	20.20	17.64	15.43	2920.0	2950.0	22.85	22.79	23.11
3030.0	45.78	41.11	38.53	18.99	16.87	15.30	3000.0	3030.0	24.77	24.83	25.22
3130.0	39.36	37.05	36.00	17.85	16.56	15.61	3100.0	3130.0	30.07	29.67	29.92
3210.0	35.40	33.94	33.47	16.88	16.15	15.61	3180.0	3210.0	29.78	28.44	28.08
3310.0	32.28	31.25	30.99	16.05	15.84	15.57	3280.0	3310.0	24.90	24.20	24.24
3390.0	30.72	29.90	29.68	15.55	15.72	15.65	3360.0	3390.0	22.39	21.86	21.81
3490.0	29.38	28.76	28.55	15.14	15.59	15.72	3460.0	3490.0	20.37	19.97	20.02

# Frequency Mixer

# RMS-30+

## Typical Performance Data

RF (IN) (MHz)	LO (MHz)	RF VSWR (:1)		
		@LO (dBm)		
		+4	+7	+10
80.0	110.0	13.92	8.77	6.39
160.0	190.0	2.91	2.62	2.50
240.0	270.0	1.81	1.70	1.64
320.0	350.0	1.45	1.34	1.28
400.0	430.0	1.30	1.21	1.15
480.0	510.0	1.27	1.26	1.27
560.0	590.0	1.23	1.20	1.20
640.0	670.0	1.60	1.51	1.45
720.0	750.0	2.86	2.65	2.48
800.0	830.0	3.76	3.47	3.22
880.0	910.0	4.03	3.86	3.67
960.0	990.0	3.80	3.77	3.70
1040.0	1070.0	3.54	3.51	3.47
1120.0	1150.0	3.25	3.20	3.17
1200.0	1230.0	2.78	2.66	2.61
1300.0	1330.0	2.74	2.55	2.41
1380.0	1410.0	3.38	3.15	3.00
1480.0	1510.0	4.07	3.83	3.67
1560.0	1590.0	4.36	4.10	3.92
1660.0	1690.0	4.44	4.16	3.97
1740.0	1770.0	4.34	4.08	3.88
1840.0	1870.0	4.14	3.88	3.70
1920.0	1950.0	3.90	3.65	3.47
2020.0	2050.0	3.59	3.33	3.14
2100.0	2130.0	3.44	3.12	2.91
2200.0	2230.0	3.17	2.82	2.58
2280.0	2310.0	2.86	2.53	2.29
2380.0	2410.0	2.48	2.16	1.92
2460.0	2490.0	2.13	1.82	1.61
2560.0	2590.0	1.76	1.50	1.34
2640.0	2670.0	1.54	1.30	1.19
2740.0	2770.0	1.23	1.15	1.23
2820.0	2850.0	1.11	1.29	1.46
2920.0	2950.0	1.38	1.62	1.83
3000.0	3030.0	1.72	1.93	2.15
3100.0	3130.0	2.21	2.37	2.54
3180.0	3210.0	2.65	2.76	2.90
3280.0	3310.0	3.26	3.32	3.43
3360.0	3390.0	3.77	3.82	3.90
3460.0	3490.0	4.39	4.40	4.46

LO (MHz)	LO VSWR (:1)		
	@LO (dBm)		
	+4	+7	+10
110.0	36.97	23.49	13.70
190.0	7.63	5.91	6.07
270.0	3.56	4.01	4.95
350.0	2.72	3.52	4.60
430.0	2.44	3.30	4.39
510.0	2.22	3.09	4.14
590.0	2.08	2.89	3.86
670.0	2.06	2.72	3.58
750.0	2.09	2.58	3.29
830.0	2.04	2.39	2.97
910.0	1.92	2.13	2.61
990.0	1.68	1.77	2.19
1070.0	1.63	1.54	1.88
1150.0	1.61	1.38	1.65
1230.0	1.48	1.22	1.52
1330.0	1.29	1.14	1.56
1410.0	1.16	1.29	1.73
1510.0	1.17	1.53	2.02
1590.0	1.27	1.73	2.27
1690.0	1.47	1.99	2.57
1770.0	1.68	2.22	2.83
1870.0	1.95	2.48	3.10
1950.0	2.18	2.68	3.27
2050.0	2.49	2.89	3.43
2130.0	2.75	3.07	3.54
2230.0	3.06	3.19	3.52
2310.0	3.30	3.26	3.47
2410.0	3.58	3.30	3.35
2490.0	3.88	3.37	3.30
2590.0	4.14	3.34	3.05
2670.0	4.26	3.17	2.67
2770.0	4.06	2.86	2.19
2850.0	3.90	2.68	1.97
2950.0	3.43	2.42	1.87
3030.0	3.02	2.30	1.99
3130.0	2.61	2.34	2.36
3210.0	2.44	2.52	2.74
3310.0	2.45	2.80	3.19
3390.0	2.59	3.06	3.50
3490.0	2.84	3.35	3.82

IF (OUT) (MHz)	IF VSWR @LO=3000MHz (:1)		
	@LO (dBm)		
	+4	+7	+10
10.0	2.42	1.99	1.71
50.0	2.33	1.91	1.65
90.0	2.36	1.94	1.66
130.0	2.21	1.82	1.57
170.0	2.13	1.77	1.53
210.0	2.01	1.68	1.48
250.0	1.86	1.56	1.37
290.0	1.78	1.52	1.37
330.0	1.59	1.39	1.31
370.0	1.55	1.38	1.34
410.0	1.45	1.38	1.41
450.0	1.40	1.37	1.46
490.0	1.41	1.46	1.59
530.0	1.39	1.49	1.64
570.0	1.44	1.57	1.74
610.0	1.48	1.65	1.87
650.0	1.51	1.68	1.89
690.0	1.58	1.78	2.00
730.0	1.60	1.77	2.00
770.0	1.64	1.81	2.03
810.0	1.65	1.80	2.01
830.0	1.65	1.79	2.00
870.0	1.65	1.74	1.92
890.0	1.66	1.74	1.91
930.0	1.61	1.63	1.75
950.0	1.62	1.61	1.71
990.0	1.60	1.53	1.59
1010.0	1.58	1.47	1.50
1050.0	1.58	1.39	1.35
1070.0	1.57	1.35	1.27
1110.0	1.60	1.33	1.17
1130.0	1.63	1.35	1.18
1170.0	1.70	1.45	1.30
1190.0	1.77	1.54	1.43
1230.0	1.93	1.77	1.71
1250.0	2.06	1.94	1.91
1290.0	2.34	2.31	2.34
1310.0	2.55	2.55	2.61
1350.0	3.01	3.10	3.20
1370.0	3.28	3.39	3.51

## Harmonics Tables

RF HARMONICS ORDER

	(-dBm)	(-dBc)										
0	-	-	2	17	22	33	12	46	22	46	38	54
1	-	23	+0	41	22	42	33	48	45	49	48	55
2	85	53	>68	61	65	61	67	63	52	>68	56	>68
3	>90	>68	67	>68	66	>68	>68	>68	>68	>68	>68	>68
4	>90	>68	>68	>68	>68	>68	>68	>68	>68	>68	>68	>68
5	>90	>68	>68	>68	>68	>68	>68	>68	>68	>68	>68	>68
6	>90	>68	>68	>68	>68	>68	>68	>68	>68	>68	>68	>68
7	>90	>68	>68	>68	>68	>68	>68	>68	>68	>68	>68	>68
8	>90	>68	>68	>68	>68	>68	>68	>68	>68	>68	>68	>68
9	>90	>68	>68	>68	>68	>68	>68	>68	>68	>68	>68	>68
10	>90	>68	>68	>68	>68	>68	>68	>68	>68	>68	>68	>68
	RF CAL	0	1	2	3	4	5	6	7	8	9	10

Test conditions: RF IN: 1600 MHz; -14.00 dBm.  
 LO IN: 1630 MHz; +7.00 dBm  
 IF OUT: 30 MHz; -21.61 dBm

RF HARMONICS ORDER

	(-dBm)	(-dBc)										
0	-	-	12	27	32	40	23	54	35	58	53	72
1	-	23	+0	42	22	44	34	52	48	54	53	61
2	65	45	57	50	57	55	61	64	46	65	52	65
3	>90	57	46	56	46	71	58	60	57	62	63	65
4	>90	71	>78	65	73	61	>78	65	78	67	65	74
5	>90	>78	>78	>78	70	72	64	>78	73	>78	72	76
6	>90	>78	>78	>78	>78	77	>78	75	>78	>78	>78	78
7	>90	>78	>78	>78	>78	>78	>78	>78	>78	>78	>78	>78
8	>90	>78	>78	>78	>78	>78	>78	>78	>78	>78	>78	>78
9	>90	>78	>78	>78	>78	>78	>78	>78	>78	>78	>78	>78
10	>90	>78	>78	>78	>78	>78	>78	>78	>78	>78	>78	>78
	RF CAL	0	1	2	3	4	5	6	7	8	9	10

### LO HARMONICS ORDER

Test conditions: RF IN: 1600 MHz; -4.00 dBm.  
 LO IN: 1630 MHz; +7.00 dBm  
 IF OUT: 30 MHz; -11.52 dBm

- Notes: 1. All Harmonics are in (dBc) relative to IF OUTPUT.  
 2. + entry denotes harmonics are in (dBc) above IF OUTPUT.  
 3. RF Cal represent the Harmonics level of the RF input signal to the mixer.

# Frequency Mixer

# RMS-30+

## Typical Performance Curves

Conversion Loss @ IF=30MHz

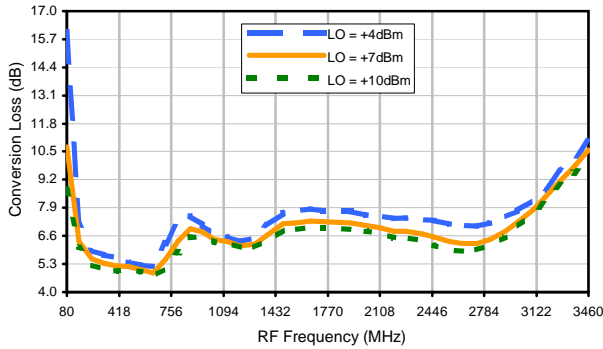

Conversion Loss vs. IF @ RF=1510.1MHz

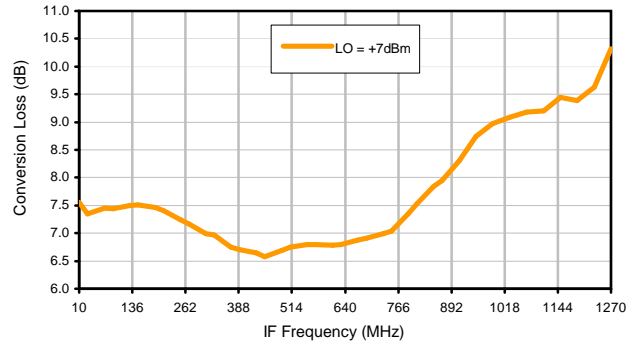

Conversion Loss vs. IF @ RF=189.9MHz

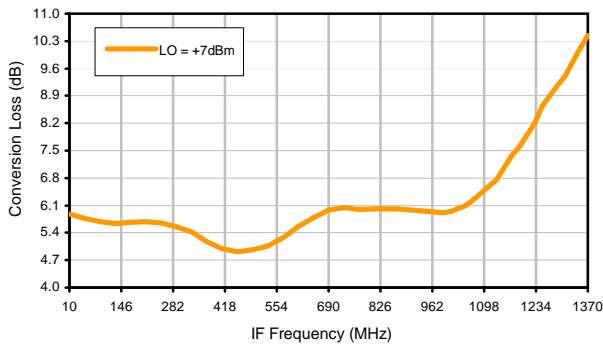

Conversion Loss vs. IF @ RF=3010.1MHz

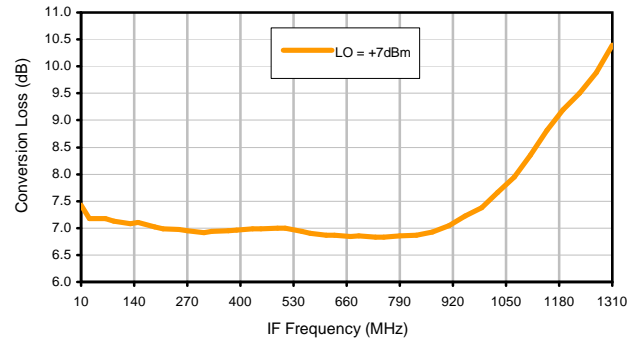

IP3 Input

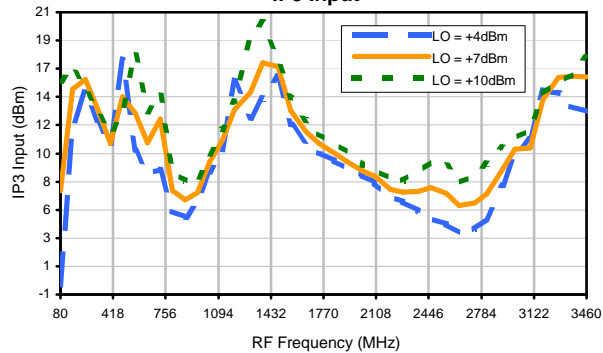

Compression @ RF IN=+1dBm

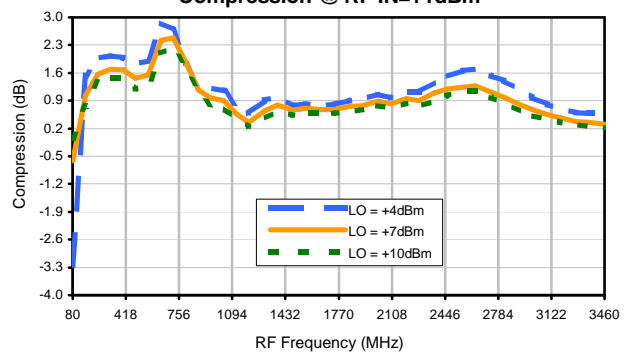

REV. X3  
RMS-30+  
101028  
Page 1 of 3



IF/RF MICROWAVE COMPONENTS • ISO 9001 ISO 14001 AS9100 CERTIFIED • RoHS compliant  
P.O. Box 350166, Brooklyn, New York 11235-0006 (718) 934-4500 Fax (718) 332-4661



The Design Engineers Search Engine finds the model you need, Instantly • For detailed performance specs & shopping online see



## Typical Performance Curves

LO-RF Isolation

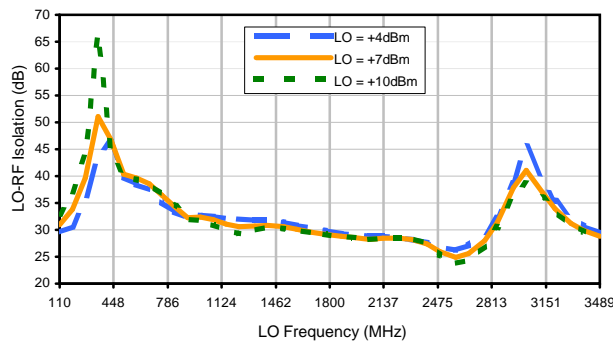

LO-IF Isolation

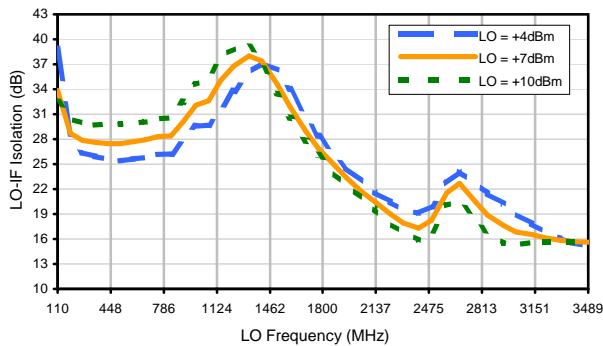

RF-IF Isolation

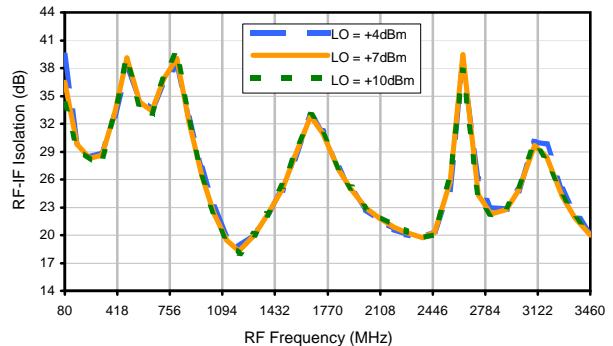

RF VSWR

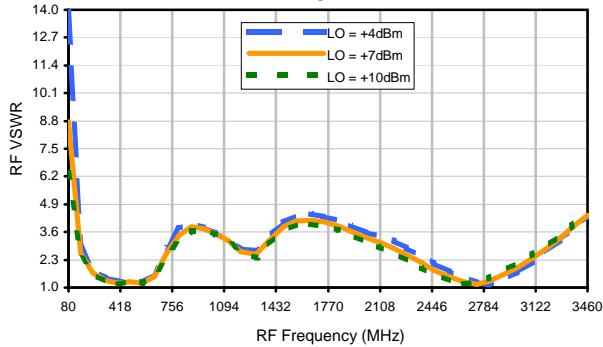

LO VSWR

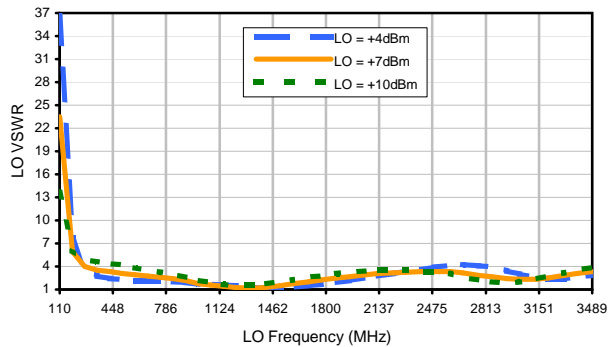

IF VSWR

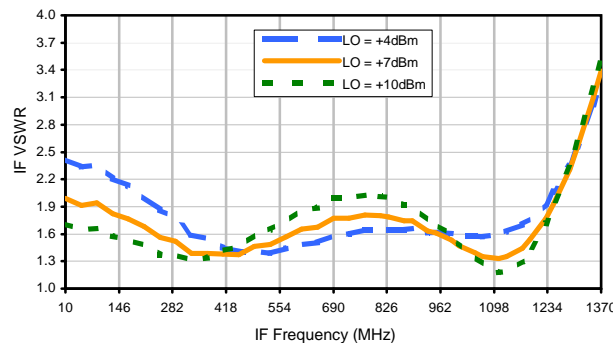

## Harmonics Tables

RF HARMONICS ORDER

	(-dBm)	(-dBc)										
0	-	-	2	17	22	33	12	46	22	46	38	54
1	-	23	+0	41	22	42	33	48	45	49	48	55
2	85	53	>68	61	65	61	67	63	52	>68	56	>68
3	>90	>68	67	>68	66	>68	>68	>68	>68	>68	>68	>68
4	>90	>68	>68	>68	>68	>68	>68	>68	>68	>68	>68	>68
5	>90	>68	>68	>68	>68	>68	>68	>68	>68	>68	>68	>68
6	>90	>68	>68	>68	>68	>68	>68	>68	>68	>68	>68	>68
7	>90	>68	>68	>68	>68	>68	>68	>68	>68	>68	>68	>68
8	>90	>68	>68	>68	>68	>68	>68	>68	>68	>68	>68	>68
9	>90	>68	>68	>68	>68	>68	>68	>68	>68	>68	>68	>68
10	>90	>68	>68	>68	>68	>68	>68	>68	>68	>68	>68	>68
	RF CAL	0	1	2	3	4	5	6	7	8	9	10

Test conditions: RF IN: 1600 MHz; -14.00 dBm.  
 LO IN: 1630 MHz; +7.00 dBm  
 IF OUT: 30 MHz; -21.61 dBm

RF HARMONICS ORDER

	(-dBm)	(-dBc)										
0	-	-	12	27	32	40	23	54	35	58	53	72
1	-	23	+0	42	22	44	34	52	48	54	53	61
2	65	45	57	50	57	55	61	64	46	65	52	65
3	>90	57	46	56	46	71	58	60	57	62	63	65
4	>90	71	>78	65	73	61	>78	65	78	67	65	74
5	>90	>78	>78	>78	70	72	64	>78	73	>78	72	76
6	>90	>78	>78	>78	>78	77	>78	75	>78	>78	>78	78
7	>90	>78	>78	>78	>78	>78	>78	>78	>78	>78	>78	>78
8	>90	>78	>78	>78	>78	>78	>78	>78	>78	>78	>78	>78
9	>90	>78	>78	>78	>78	>78	>78	>78	>78	>78	>78	>78
10	>90	>78	>78	>78	>78	>78	>78	>78	>78	>78	>78	>78
	RF CAL	0	1	2	3	4	5	6	7	8	9	10

### LO HARMONICS ORDER

Test conditions: RF IN: 1600 MHz; -4.00 dBm.  
 LO IN: 1630 MHz; +7.00 dBm  
 IF OUT: 30 MHz; -11.52 dBm

- Notes: 1. All Harmonics are in (dBc) relative to IF OUTPUT.  
 2. + entry denotes harmonics are in (dBc) above IF OUTPUT.  
 3. RF Cal represent the Harmonics level of the RF input signal to the mixer.

### Outline Dimensions

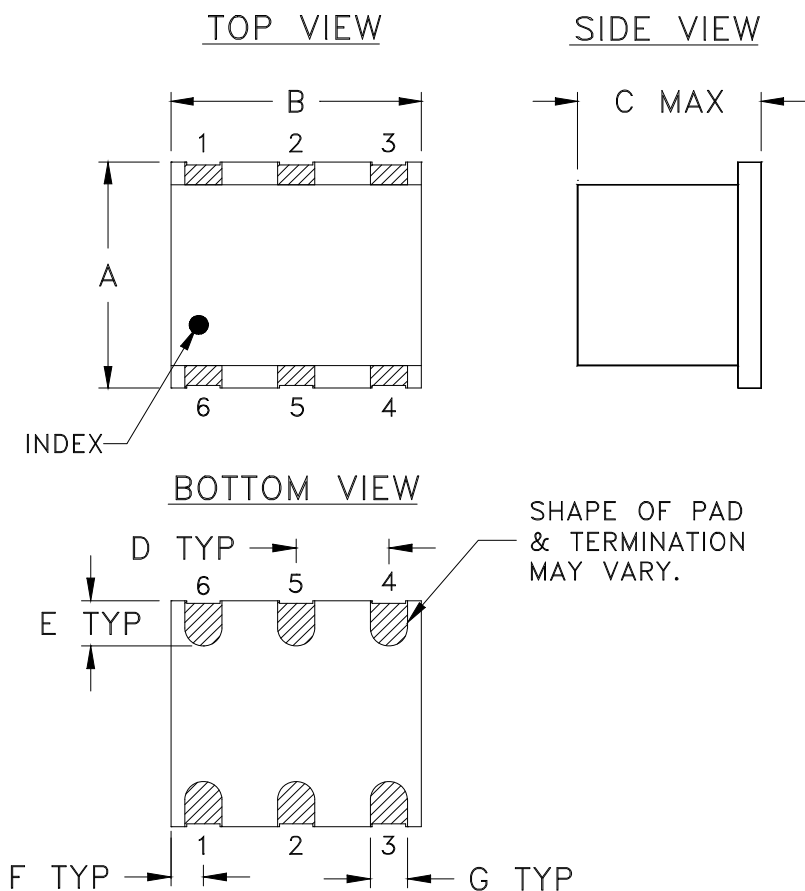

### PCB Land Pattern

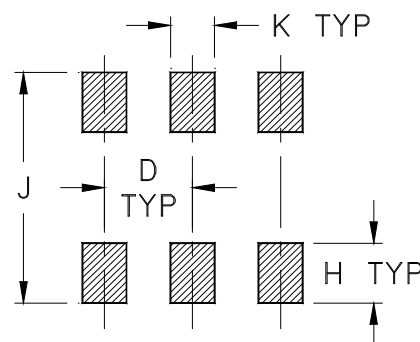

Suggested Layout,  
Tolerance to be within  $\pm .002$

CASE #	A	B	C	D	E	F	G	H	J	K	WT. GRAM
TT240	.250 (6.35)	.31 (7.87)	.20 (5.08)	.100 (2.54)	.050 (1.27)	.055 (1.40)	.040 (1.02)	.070 (1.78)	.270 (6.86)	.050 (1.27)	.50

Dimensions are in inches (mm). Tolerances: 2Pl.  $\pm .01$ ; 3 Pl.  $\pm .005$

#### Notes:

- Case material: Ceramic.
- Termination finish:
  - For RoHS Case Styles: 2-10 $\mu$  inch (.05-.25 microns) Gold plate over 100-300  $\mu$  inch (2.54-7.62 microns) Nickel plate. All models, (+) suffix.
  - For RoHS-5 Case Styles: Tin-Lead plate. All models, no (+) suffix.



P.O. Box 350166, Brooklyn, New York 11235-0003 (718) 934-4500 Fax (718) 332-4661 For detailed performance specs & shopping online see Mini-Circuits web site



The Design Engineers Search Engine Provides ACTUAL Data Instantly From MINI-CIRCUITS At: [www.minicircuits.com](http://www.minicircuits.com)

RF/IF MICROWAVE COMPONENTS

# Tape & Reel Packaging TR-F2

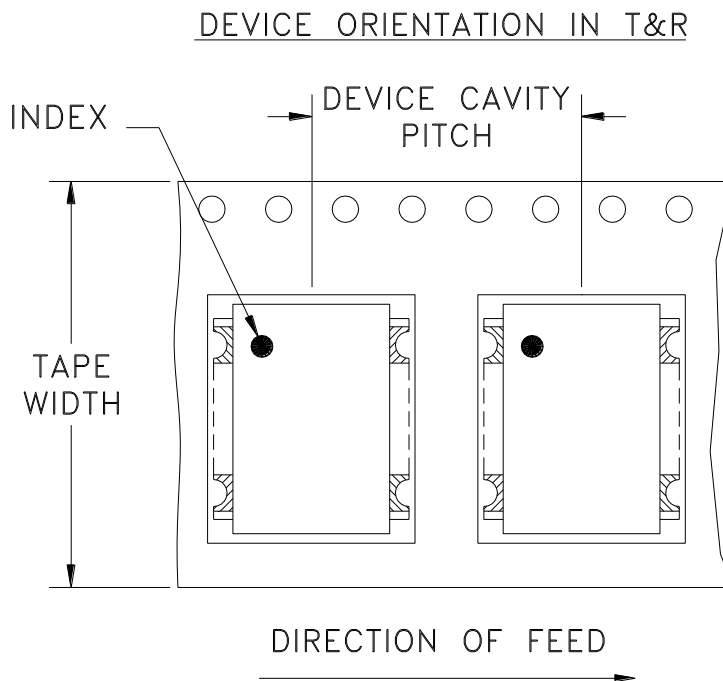

Tape Width, mm	Device Cavity Pitch, mm	Reel Size, inches	Devices per Reel See note
16	12	7	10
			20
			50
			100
		13	500

Note: Please consult individual model data sheet to determine device per reel availability

Mini-Circuits carrier tape materials provide protection from ESD (Electro-Static Discharge) during handling and transportation. Tapes are static dissipative and comply with industry standards EIA-481/EIA-541.

Go to: [www.minicircuits.com/pages/pdfs/tape.pdf](http://www.minicircuits.com/pages/pdfs/tape.pdf)



INTERNET <http://www.minicircuits.com>

P.O. Box 350166, Brooklyn, New York 11235-0003 (718) 934-4500 Fax (718) 332-4661

Distribution Centers NORTH AMERICA 800-654-7949 • 417-335-5935 • Fax 417-335-5945 • EUROPE 44-1252-832600 • Fax 44-1252-837010

Mini-Circuits ISO 9001 & ISO 14001 Certified

THIRD ANGLE PROJECTION



REVISIONS

REV	ECN No.	DESCRIPTION	DATE	DR	AUTH
A	M101143	ADDED "gk" PIN CONNECTION, TT100 CASE STYLE & NOTE 2	10/10/05	MMG	DJ
B	M102713	ADDED "...WITH SMOBC"	01/17/06	MMG	IL
C	M108637	REMOVED "PIN 1", ADDED INDEX ON UNIT	12/01/06	MYG	FL

SUGGESTED MOUNTING CONFIGURATION  
FOR BH292, CD541/542/636/637, TT100/240 CASE  
STYLES, "gk", "ht", "hu", "nd", "w" PIN CONNECTIONS



- NOTES:** 1. TRACE WIDTH IS SHOWN FOR ROGERS R04350B WITH DIELECTRIC THICKNESS .030" ± .002"; COPPER: 1/2 OZ. EACH SIDE. FOR OTHER MATERIALS TRACE WIDTH MAY NEED TO BE MODIFIED.  
 2. BOTTOM SIDE OF THE PCB IS CONTINUOUS GROUND PLANE.

- DENOTES PCB COPPER LAYOUT WITH SMOBC (SOLDER MASK OVER BARE COPPER)
- DENOTES COPPER LAND PATTERN FREE OF SOLDER MASK

UNLESS OTHERWISE SPECIFIED	INITIALS	DATE
DIMENSIONS ARE IN INCHES	MMG	07/17/02
TOLERANCES ON:	WL	08/02/02
2 PL DECIMALS ±	DJ	08/05/02
3 PL DECIMALS ± .005		
ANGLES ±		
FRACTIONS ±		

**Mini-Circuits®** 13 Neptune Avenue  
 Brooklyn NY 11235

PL, gk/ht/hu/nd/w, BH292,  
 CD541/542/636/637, TT100/240, TB-03

SIZE A	CODE IDENT 15542	DRAWING NO: 98-PL-052	REV: C
FILE: 98PL052	SCALE: 8:1	SHEET: 1 OF 1	

Mini-Circuits®  
 THIS DOCUMENT AND ITS CONTENTS ARE THE PROPERTY OF MINI-CIRCUITS. EXCEPT FOR USE EXPRESSLY GRANTED, IN WRITING, TO ITS VENDORS, VENDEE AND THE UNITED STATES GOVERNMENT, MINI-CIRCUITS RESERVES ALL PROPRIETARY DESIGN, USE, MANUFACTURING AND REPRODUCTION RIGHTS THERETO. THESE CONTENTS SHALL NOT BE USED, DUPLICATED OR DISCLOSED TO ANY OUTSIDE PARTY, IN WHOLE OR IN PART, WITHOUT WRITTEN PERMISSION OF MINI-CIRCUITS.

THIRD ANGLE PROJECTION



REVISIONS

REV	ECN No.	DESCRIPTION	DATE	DR	AUTH
E	M119737	UPDATED PCB	10.08	MF	AD
F	M127659	UPDATED CARR	06.10	SW	SG
G	M127846	UPDATED SCHEMATIC DIAGRAM	06.10	SW	SG
H	M131840	UPDATED DWG	05.11	MF	AD



**NOTES:**

1. REFER TO -09 PAGE FOR ITEM DESCRIPTIONS.  
DESIGNATION NUMBERS ON -20 PAGE CORRESPOND TO THE NUMBERS ON -09 PAGE.
2. FOR TEXT HEIGHT & STYLE ON THE LABEL REFER TO: D3-G209.

UNLESS OTHERWISE SPECIFIED	INITIALS	DATE
DIMENSIONS ARE IN INCHES TOLERANCES ON: 2 PL DECIMALS ± 3 PL DECIMALS ± ANGLES ± FRACTIONS ±	DRAWN	S.WOLYNSKI 06.29.99
	CHECKED	SG 07.06.99
	APPROVED	MG 07.10.99

 **Mini-Circuits®** 13 Neptune Avenue  
Brooklyn NY 11235

TB,ADE,CD542/636,06MX01,50

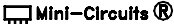
 Mini-Circuits®  
THIS DOCUMENT AND ITS CONTENTS ARE THE PROPERTY OF MINI-CIRCUITS. EXCEPT FOR USE EXPRESSLY GRANTED, IN WRITING, TO ITS VENDORS, VENDEE AND THE UNITED STATES GOVERNMENT, MINI-CIRCUITS RESERVES ALL PROPRIETARY DESIGN, USE, MANUFACTURING AND REPRODUCTION RIGHTS THERETO. THESE CONTENTS SHALL NOT BE USED, DUPLICATED OR DISCLOSED TO ANY OUTSIDE PARTY, IN WHOLE OR IN PART, WITHOUT WRITTEN PERMISSION OF MINI-CIRCUITS.

SIZE A	CODE IDENT 15542	DRAWING NO: TB-03-20	REV: H
FILE: WTB-03	SCALE: 1.5:1	SHEET: 1 OF 2	

# Evaluation Board and Circuit

For Pin Connections and DUT Orientation Refer to  
Data Sheet of the DUT



TB-03



Schematic Diagram

## Notes:

1. 50 Ohm SMA Female connectors.
2. PCB Material: Rogers R04350 or equivalent,  
Dielectric Constant=3.5, Thickness=.030 inch.

 **Mini-Circuits®**

All Mini-Circuits products are manufactured under exacting quality assurance and control standards, and are capable of meeting published specifications after being subjected to any or all of the following physical and environmental test.

Specification	Test/Inspection Condition	Reference/Spec
Operating Temperature	-40° to 85°C Ambient Environment	Individual Model Data Sheet
Storage Temperature	-55° to 100° C Ambient Environment	Individual Model Data Sheet
Humidity	90 to 95% RH, 240 hours, 50°C	MIL-STD-202, Method 103, Condition A, Except 50°C and end-point electrical test done within 12 hours
Thermal Shock	-55° to 100°C, 100 cycles	MIL-STD-202, Method 107, Condition A-3, except +100°C
Solder Reflow Heat	Sn-Pb Eutetic Process: 225°C peak Pb-Free Process 245° - 250°C peak	J-STD-020, Table 4-1, 4-2 and 5-2, Figure 5-1
Solderability	10X Magnification	J-STD-002, 95% Coverage
Vibration (High Frequency)	20g peak, 10-2000 Hz, 12 times in each of three perpendicular directions (total 36)	MIL-STD-202, Method 204, Condition D
Mechanical Shock	50g, 11 ms, 1/2-sine, 18 shocks: 3 each direction, each of 3 axes	MIL-STD-202, Method 213, Condition A
Marking Resistance to Solvents	Isopropyl alcohol + mineral spirits at 25°C; terpene defluxer at 25°C; distilled water + proylene glycol monomethyl ether + monoethanolamine at 63°C to 70°C	MIL-STD-202, Method 215