

Surface Mount

Voltage Controlled Oscillator

ROS-2940C+

Low Noise 2935 to 2940 MHz

Features

- linear tuning characteristics
- low phase noise
- low pulling
- low pushing
- aqueous washable

Applications

- wireless communications
- military & avionics



CASE STYLE: CK1113

+RoHS Compliant

The +Suffix identifies RoHS Compliance. See our web site for RoHS Compliance methodologies and qualifications

Electrical Specifications

| MODEL NO. | FREQ. (MHz) | | POWER OUTPUT (dBm) | PHASE NOISE dBc/Hz SSB at offset frequencies, kHz | | | | TUNING | | | | NON HARMONIC SPURIOUS (dBc) | HARMONICS (dBc) | | PULLING pk-pk @12 dB _r (MHz) | PUSHING (MHz/V) | DC OPERATING POWER | | |
|------------|-------------|------|--------------------|---|------|------|------|--------|-------------------|-----------------------|---------------|-----------------------------|---------------------------------|------|---|-----------------|--------------------|-------------------------|--------------|
| | Min. | Max. | | Typ. | 1 | 10 | 100 | 1000 | VOLTAGE RANGE (V) | SENSI- TIVITY (MHz/V) | PORT CAP (pF) | | 3 dB MODULATION BANDWIDTH (MHz) | Typ. | | | Max. | V _{cc} (volts) | Current (mA) |
| ROS-2940C+ | 2935 | 2940 | +4.5 | -87 | -115 | -134 | -154 | 0.5 | 5.0 | 13 - 14 | 20 | 150 | -90 | -17 | -10 | 0.6 | 0.8 | 7 | 40 |

Pin Connections

| | |
|--------|--------------------------------|
| RF OUT | 10 |
| VCC | 14 |
| V-TUNE | 2 |
| GROUND | 1,3,4,5,6,7,8,9,11,12,13,15,16 |

Maximum Ratings

| | |
|---|----------------|
| Operating Temperature | -55°C to 85°C |
| Storage Temperature | -55°C to 100°C |
| Absolute Max. Supply Voltage (V _{cc}) | 8V |
| Absolute Max. Tuning Voltage (V _{tune}) | 7V |
| All specifications | 50 ohm system |

Permanent damage may occur if any of these limits are exceeded.

Tape & Reel: F37

7" Reels with 10, 20, 50, 100 devices
13" Reels with 200, 500 devices

Environmental Ratings: ENV65

Outline Drawing

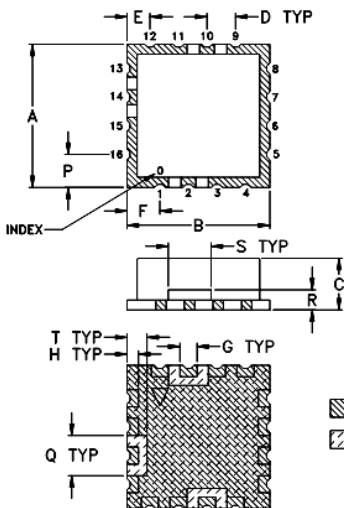

PCB Land Pattern

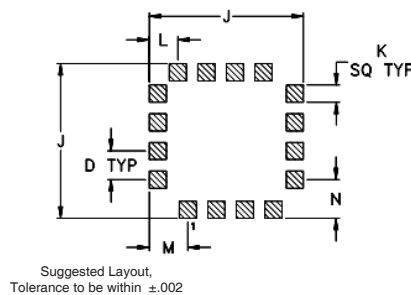

Demo Board MCL P/N: TB-10 Suggested PCB Layout (PL-012)

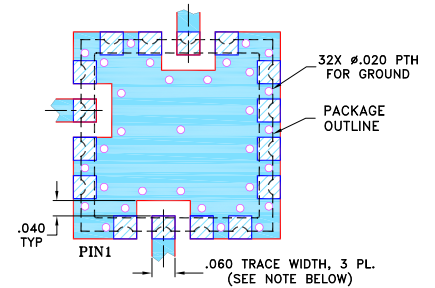

NOTES:

1. TRACE WIDTH IS SHOWN FOR FR4 WITH DIELECTRIC THICKNESS .030" ± .002"; COPPER: 1/2 OZ. EACH SIDE. FOR OTHER MATERIALS TRACE WIDTH MAY NEED TO BE MODIFIED.
 2. BOTTOM SIDE OF THE BOTTOM IS CONTINUOUS GROUND PLANE.
-

Outline Dimensions (inch/mm)

| A | B | C | D | E | F | G | H | J | K | L | M | N | P | Q | R | S | T | wt. |
|-------|-------|------|------|------|------|------|------|-------|------|------|------|------|------|------|------|------|------|-------|
| .500 | .500 | .220 | .100 | .080 | .115 | .060 | .040 | .540 | .100 | .135 | .135 | .115 | .140 | .070 | .150 | .070 | | grams |
| 12.70 | 12.70 | 5.59 | 2.54 | 2.03 | 2.92 | 1.52 | 1.02 | 13.72 | 1.52 | 2.54 | 3.43 | 3.43 | 2.92 | 3.56 | 1.78 | 3.81 | 1.78 | 1.2 |

NON-CATALOG Performance Data & Curves*

ROS-2940C+

| V TUNE | TUNE SENS (MHz/V) | FREQUENCY (MHz) | | | POWER OUTPUT (dBm) | | | Icc (mA) | HARMONICS (dBc) | | | FREQ. PUSH (MHz/V) | FREQ. PULL (MHz) | PHASE NOISE (dBc/Hz) at offsets | | | | FREQ OFFSET (KHz) | PHASE NOISE at 2938 MHz (dBc/Hz) |
|--------|-------------------|-----------------|--------|--------|--------------------|-------|-------|----------|-----------------|-------|-------|--------------------|------------------|---------------------------------|--------|--------|--------|-------------------|----------------------------------|
| | | -55°C | +25°C | +85°C | -55°C | +25°C | +85°C | | F2 | F3 | F4 | | | 1kHz | 10kHz | 100kHz | 1MHz | | |
| 0.00 | 15.96 | 2908.6 | 2903.0 | 2897.2 | 4.79 | 4.32 | 3.90 | 35.48 | -16.6 | -34.4 | -37.1 | 0.69 | 0.54 | -87.20 | -115.8 | -132.3 | -153.5 | 1.0 | -85.86 |
| 0.50 | 14.61 | 2916.2 | 2910.8 | 2905.2 | 4.91 | 4.41 | 3.98 | 35.57 | -16.7 | -33.3 | -38.0 | 0.77 | 0.39 | -88.15 | -115.6 | -134.0 | -154.6 | 2.0 | -95.38 |
| 0.75 | 14.44 | 2919.8 | 2914.4 | 2908.8 | 4.96 | 4.45 | 4.01 | 35.60 | -16.6 | -32.9 | -36.3 | 0.80 | 0.31 | -87.27 | -115.6 | -134.4 | -154.2 | 3.5 | -102.70 |
| 1.00 | 14.41 | 2923.4 | 2918.1 | 2912.4 | 5.01 | 4.48 | 4.03 | 35.64 | -16.7 | -32.5 | -35.6 | 0.82 | 0.29 | -88.45 | -115.9 | -134.0 | -154.5 | 6.0 | -109.23 |
| 1.25 | 14.46 | 2927.0 | 2921.7 | 2916.0 | 5.04 | 4.51 | 4.05 | 35.66 | -16.7 | -31.7 | -34.5 | 0.83 | 0.29 | -87.03 | -115.4 | -133.5 | -154.5 | 8.5 | -113.30 |
| 1.50 | 14.52 | 2930.6 | 2925.3 | 2919.7 | 5.06 | 4.54 | 4.08 | 35.69 | -16.7 | -31.5 | -34.7 | 0.85 | 0.29 | -87.80 | -114.6 | -133.7 | -154.5 | 10.0 | -114.82 |
| 1.75 | 14.58 | 2934.2 | 2928.9 | 2923.3 | 5.07 | 4.55 | 4.10 | 35.71 | -16.7 | -30.9 | -36.1 | 0.85 | 0.32 | -85.86 | -114.8 | -134.9 | -154.6 | 20.8 | -122.53 |
| 2.00 | 14.56 | 2937.9 | 2932.5 | 2926.9 | 5.07 | 4.55 | 4.11 | 35.72 | -16.8 | -30.7 | -36.4 | 0.84 | 0.39 | -86.25 | -115.2 | -133.6 | -155.2 | 35.5 | -127.27 |
| 2.25 | 14.43 | 2941.5 | 2936.2 | 2930.6 | 5.08 | 4.54 | 4.11 | 35.73 | -16.8 | -30.4 | -34.7 | 0.83 | 0.46 | -87.49 | -115.4 | -134.0 | -154.4 | 60.7 | -130.31 |
| 2.50 | 14.14 | 2945.1 | 2939.8 | 2934.2 | 5.07 | 4.53 | 4.11 | 35.73 | -16.9 | -30.2 | -33.3 | 0.80 | 0.51 | -86.05 | -115.0 | -133.7 | -153.9 | 86.7 | -132.12 |
| 2.75 | 13.68 | 2948.6 | 2943.3 | 2937.7 | 5.07 | 4.52 | 4.10 | 35.73 | -16.9 | -30.2 | -32.8 | 0.77 | 0.55 | -85.97 | -114.6 | -134.6 | -154.3 | 100.0 | -133.51 |
| 3.00 | 13.06 | 2952.0 | 2946.7 | 2941.1 | 5.04 | 4.51 | 4.10 | 35.72 | -17.0 | -29.8 | -33.7 | 0.74 | 0.57 | -86.24 | -115.1 | -134.0 | -154.2 | 148.1 | -135.59 |
| 3.25 | 12.33 | 2955.3 | 2950.0 | 2944.4 | 5.01 | 4.50 | 4.09 | 35.71 | -17.2 | -29.7 | -35.4 | 0.70 | 0.57 | -85.05 | -114.2 | -133.3 | -155.0 | 177.0 | -136.88 |
| 3.50 | 11.52 | 2958.3 | 2953.1 | 2947.5 | 4.98 | 4.47 | 4.09 | 35.70 | -17.1 | -29.2 | -35.5 | 0.68 | 0.56 | -85.70 | -115.1 | -134.0 | -155.1 | 211.6 | -138.00 |
| 3.75 | 10.65 | 2961.2 | 2956.0 | 2950.4 | 4.94 | 4.43 | 4.08 | 35.69 | -17.1 | -28.7 | -34.0 | 0.66 | 0.53 | -86.31 | -115.6 | -134.3 | -154.1 | 302.4 | -140.26 |
| 4.00 | 9.76 | 2963.8 | 2958.6 | 2953.1 | 4.91 | 4.41 | 4.06 | 35.67 | -17.4 | -28.4 | -33.4 | 0.65 | 0.54 | -86.44 | -114.4 | -133.9 | -153.6 | 361.5 | -142.67 |
| 4.25 | 8.89 | 2966.3 | 2961.1 | 2955.5 | 4.88 | 4.38 | 4.04 | 35.66 | -17.2 | -28.2 | -32.9 | 0.66 | 0.53 | -86.84 | -114.6 | -134.1 | -154.1 | 507.5 | -146.28 |
| 4.50 | 8.06 | 2968.5 | 2963.3 | 2957.8 | 4.85 | 4.35 | 4.02 | 35.65 | -17.3 | -28.0 | -32.9 | 0.67 | 0.52 | -88.92 | -114.9 | -133.3 | -155.4 | 606.7 | -149.08 |
| 4.75 | 7.30 | 2970.4 | 2965.3 | 2959.8 | 4.82 | 4.33 | 4.00 | 35.63 | -17.3 | -28.0 | -33.1 | 0.69 | 0.51 | -86.70 | -114.7 | -133.5 | -154.8 | 851.6 | -151.58 |
| 5.00 | 6.61 | 2972.2 | 2967.1 | 2961.7 | 4.79 | 4.30 | 3.99 | 35.62 | -17.3 | -28.0 | -33.4 | 0.71 | 0.49 | -86.86 | -114.3 | -134.1 | -154.2 | 1000.0 | -153.86 |

*at 25°C unless mentioned otherwise

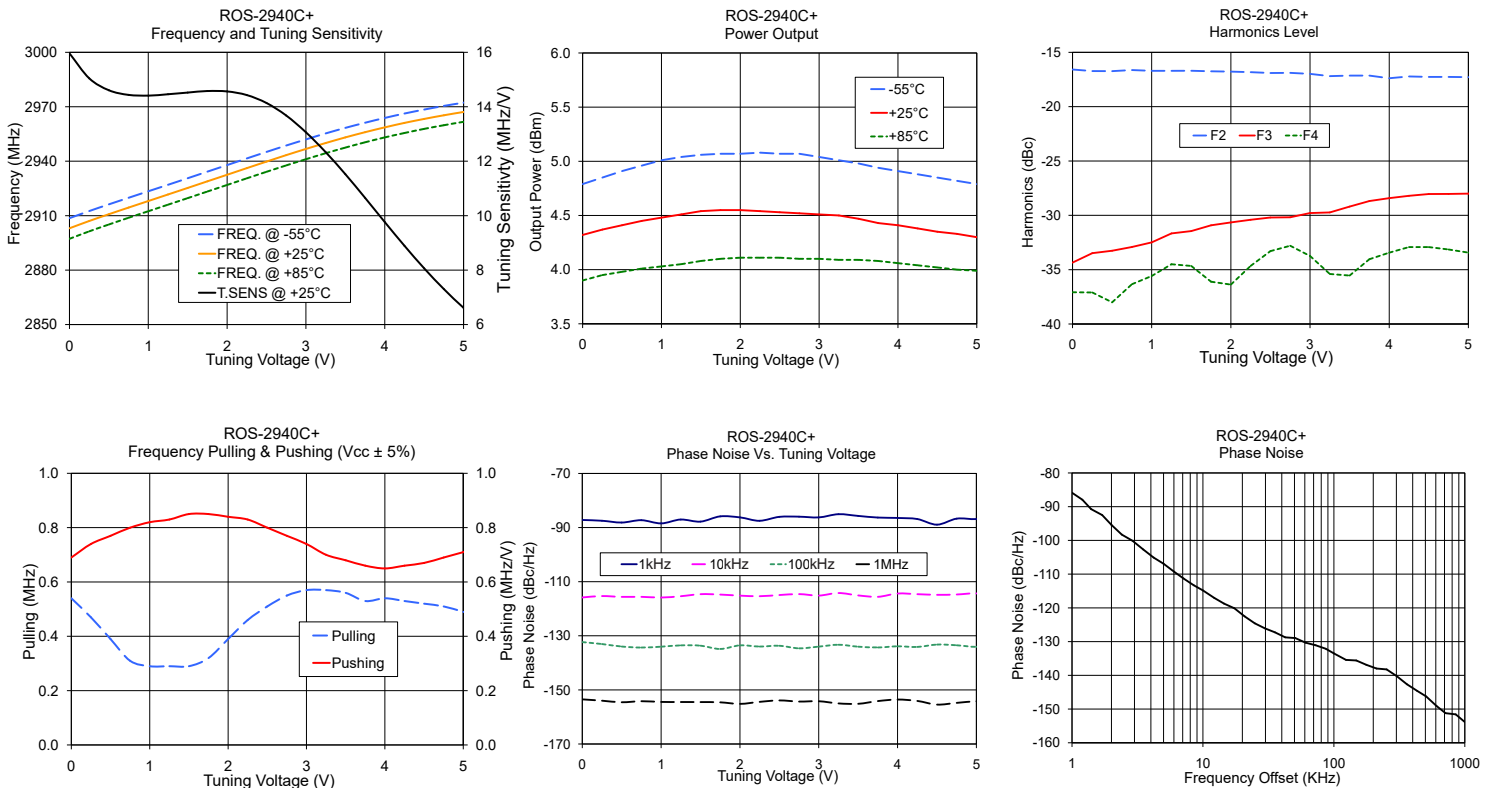

Additional Notes

- Performance and quality attributes and conditions not expressly stated in this specification document are intended to be excluded and do not form a part of this specification document.
- Electrical specifications and performance data contained in this specification document are based on Mini-Circuits' applicable established test performance criteria and measurement instructions.
- The parts covered by this specification document are subject to Mini-Circuits standard limited warranty and terms and conditions (collectively, "Standard Terms"); Purchasers of this part are entitled to the rights and benefits contained therein. For a full statement of the Standard Terms and the exclusive rights and remedies thereunder, please visit Mini-Circuits' website at www.minicircuits.com/MCLStore/terms.jsp



Voltage Controlled Oscillator

ROS-2940C+

Typical Performance Data

| V TUNE | TUNE SENS (MHz/V) | FREQUENCY (MHz) | | | POWER OUTPUT (dBm) | | | HARMONICS (dBc) | | | FREQ. PUSH (MHz/V) | FREQ OFFSET (KHz) | PHASE NOISE (dBc/Hz) |
|-----------|-------------------------|--------------------|--------|--------|-----------------------|-------|-------|-----------------|-------|-------|--------------------------|-------------------------|----------------------------|
| | | -55°C | +25°C | +85°C | -55°C | +25°C | +85°C | F2 | F3 | F4 | | | |
| 0.0 | 15.89 | 2919.3 | 2915.8 | 2913.3 | 4.25 | 3.79 | 3.31 | -17.4 | -32.0 | -37.1 | 0.55 | 1 | -89 |
| 0.3 | 14.91 | 2923.1 | 2919.8 | 2917.4 | 4.25 | 3.78 | 3.31 | -17.4 | -31.4 | -36.8 | 0.58 | 10 | -116 |
| 0.5 | 14.41 | 2926.8 | 2923.5 | 2921.2 | 4.25 | 3.77 | 3.31 | -17.4 | -30.9 | -38.0 | 0.60 | 100 | -137 |
| 0.8 | 14.16 | 2930.3 | 2927.1 | 2924.8 | 4.27 | 3.77 | 3.30 | -17.5 | -30.8 | -38.1 | 0.62 | 1000 | -156 |
| 1.0 | 14.07 | 2933.8 | 2930.7 | 2928.4 | 4.28 | 3.78 | 3.30 | -17.5 | -30.7 | -37.2 | 0.63 | | |
| 1.3 | 14.10 | 2937.3 | 2934.2 | 2931.9 | 4.29 | 3.79 | 3.31 | -17.4 | -30.4 | -36.2 | 0.63 | | |
| 1.5 | 14.23 | 2940.8 | 2937.7 | 2935.4 | 4.30 | 3.80 | 3.32 | -17.4 | -30.0 | -35.7 | 0.64 | | |
| 1.8 | 14.45 | 2944.3 | 2941.3 | 2938.9 | 4.30 | 3.81 | 3.33 | -17.4 | -29.6 | -36.5 | 0.64 | | |
| 2.0 | 14.75 | 2947.9 | 2944.9 | 2942.6 | 4.29 | 3.81 | 3.35 | -17.4 | -29.3 | -37.7 | 0.65 | | |
| 2.3 | 15.09 | 2951.6 | 2948.6 | 2946.2 | 4.27 | 3.80 | 3.36 | -17.5 | -29.3 | -37.3 | 0.65 | | |
| 2.5 | 15.45 | 2955.3 | 2952.4 | 2950.0 | 4.25 | 3.79 | 3.36 | -17.6 | -29.3 | -36.7 | 0.64 | | |
| 2.8 | 15.85 | 2959.2 | 2956.2 | 2953.8 | 4.22 | 3.78 | 3.36 | -17.8 | -29.2 | -36.6 | 0.63 | | |
| 3.0 | 16.28 | 2963.2 | 2960.2 | 2957.8 | 4.19 | 3.75 | 3.35 | -18.1 | -28.7 | -36.0 | 0.63 | | |
| 3.3 | 16.70 | 2967.2 | 2964.3 | 2961.8 | 4.15 | 3.73 | 3.34 | -18.4 | -28.1 | -35.4 | 0.61 | | |
| 3.5 | 17.10 | 2971.4 | 2968.4 | 2965.9 | 4.09 | 3.70 | 3.33 | -18.6 | -27.5 | -36.0 | 0.60 | | |
| 3.8 | 17.46 | 2975.7 | 2972.7 | 2970.2 | 4.05 | 3.67 | 3.32 | -18.8 | -27.1 | -37.8 | 0.57 | | |
| 4.0 | 17.75 | 2980.1 | 2977.1 | 2974.5 | 3.97 | 3.63 | 3.30 | -18.9 | -27.6 | -36.9 | 0.54 | | |
| 4.3 | 17.95 | 2984.5 | 2981.5 | 2978.9 | 3.89 | 3.57 | 3.27 | -18.8 | -27.4 | -36.2 | 0.50 | | |
| 4.5 | 18.02 | 2989.1 | 2986.0 | 2983.4 | 3.80 | 3.51 | 3.23 | -18.8 | -27.4 | -35.3 | 0.46 | | |
| 4.8 | 17.90 | 2993.6 | 2990.5 | 2987.8 | 3.71 | 3.45 | 3.19 | -18.7 | -27.0 | -36.1 | 0.39 | | |
| 5.0 | 17.53 | 2998.1 | 2995.0 | 2992.3 | 3.62 | 3.39 | 3.15 | -18.8 | -27.1 | -35.5 | 0.31 | | |
| 5.3 | 16.94 | 3002.5 | 2999.4 | 2996.7 | 3.51 | 3.33 | 3.10 | -18.9 | -26.2 | -35.2 | 0.23 | | |
| 5.5 | 16.16 | 3006.8 | 3003.6 | 3000.9 | 3.40 | 3.25 | 3.06 | -19.0 | -25.5 | -36.0 | 0.14 | | |
| 5.8 | 15.20 | 3010.8 | 3007.6 | 3004.9 | 3.30 | 3.17 | 3.00 | -19.2 | -24.9 | -36.3 | 0.05 | | |
| 6.0 | 14.12 | 3014.6 | 3011.4 | 3008.7 | 3.21 | 3.10 | 2.93 | -19.4 | -24.2 | -37.0 | 0.02 | | |
| 6.3 | 12.95 | 3018.2 | 3015.0 | 3012.2 | 3.14 | 3.04 | 2.89 | -19.7 | -24.3 | -36.4 | 0.06 | | |
| 6.5 | 11.73 | 3021.4 | 3018.2 | 3015.5 | 3.08 | 2.99 | 2.84 | -19.9 | -24.1 | -36.5 | 0.09 | | |
| 6.8 | 10.52 | 3024.3 | 3021.1 | 3018.4 | 3.03 | 2.94 | 2.81 | -20.1 | -24.6 | -37.1 | 0.08 | | |
| 7.0 | 10.52 | 3027.0 | 3023.8 | 3021.1 | 2.99 | 2.91 | 2.78 | -20.3 | -24.3 | -37.8 | 0.06 | | |



Voltage Controlled Oscillator

ROS-2940C+

Typical Performance Data

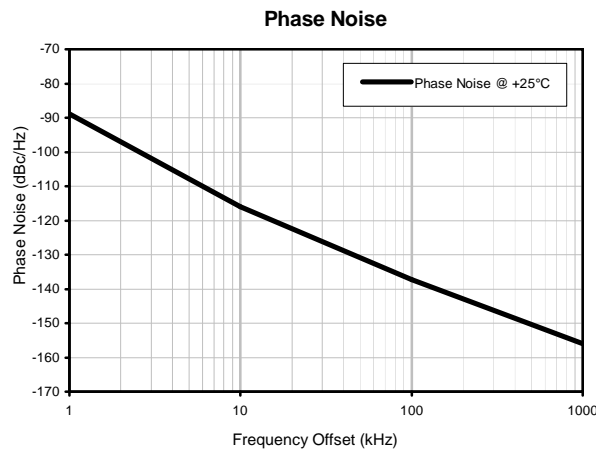
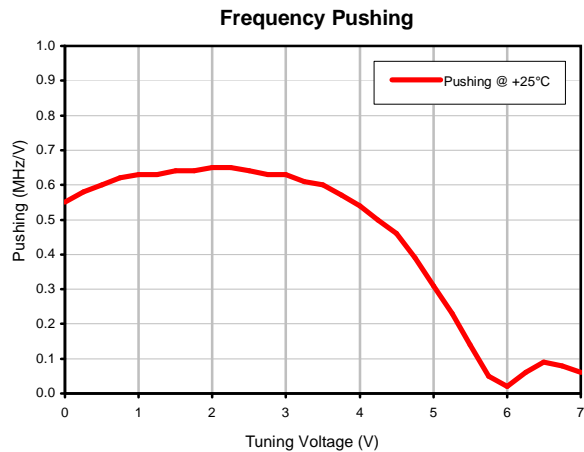
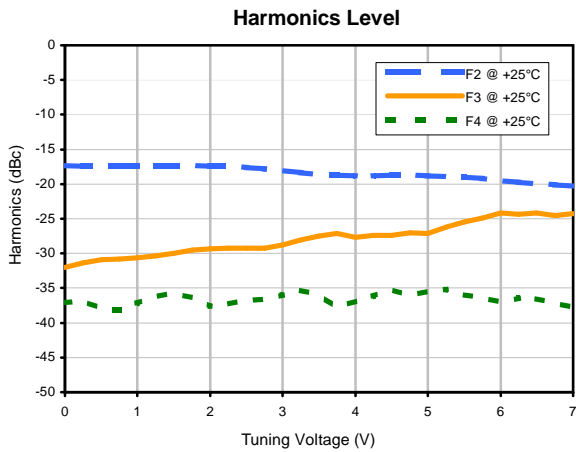
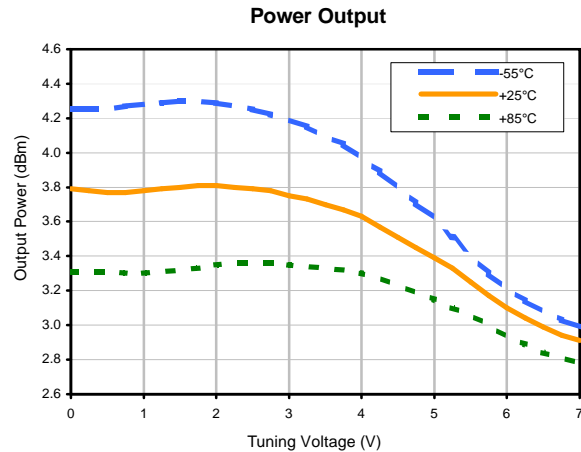
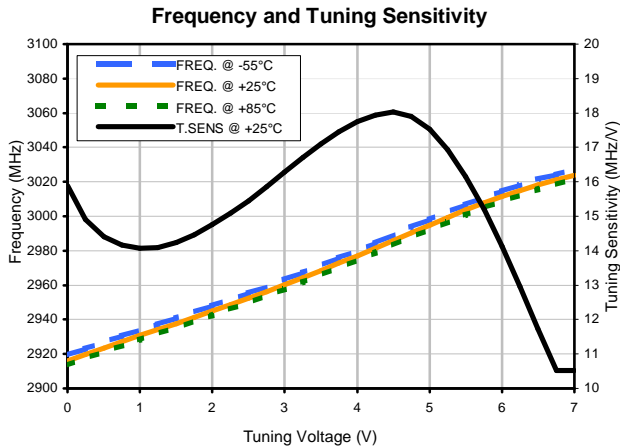

CK1113

Outline Dimensions

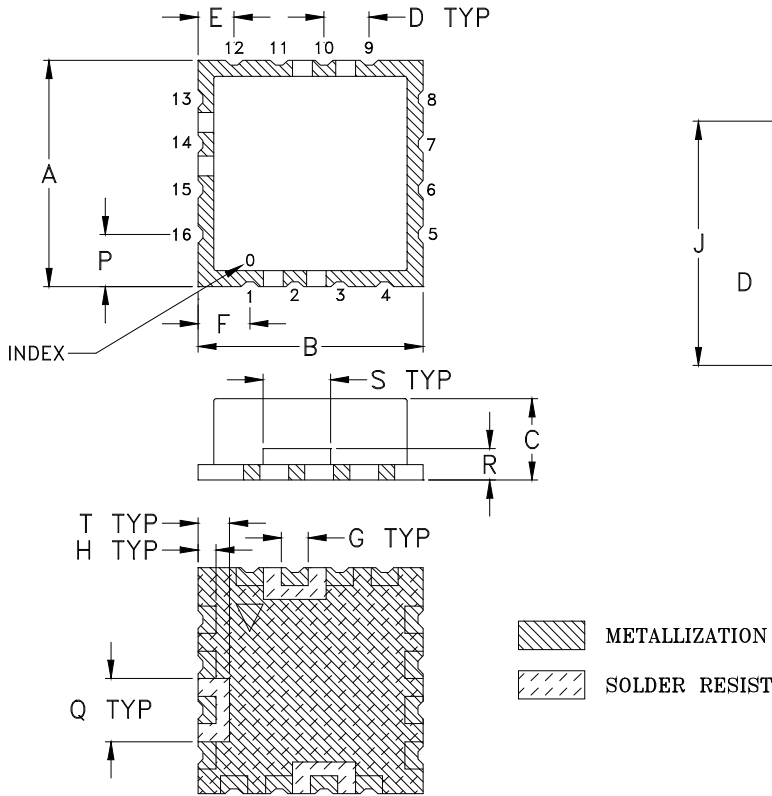

PCB Land Pattern

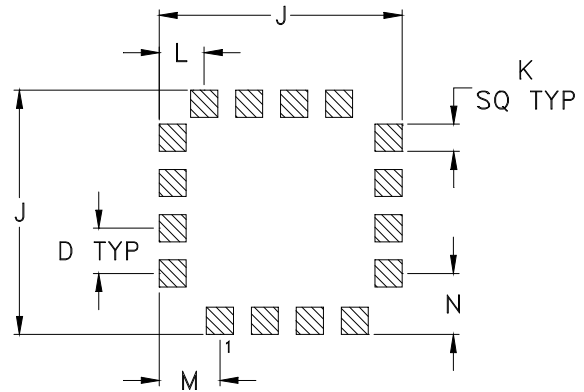

Suggested Layout,
Tolerance to be within $\pm .002$

| CASE # | A | B | C | D | E | F | G | H | J | K |
|--------|-----------------|-----------------|----------------|----------------|----------------|----------------|----------------|----------------|-----------------|----------------|
| CK1113 | .500 (12.70) | .500 (12.70) | .220 (5.59) | .100 (2.54) | .080 (2.03) | .115 (2.92) | .060 (1.52) | .040 (1.02) | .540 (13.72) | .060 (1.52) |

| CASE # | L | M | N | P | Q | R | S | T | WT. GRAM |
|--------|----------------|----------------|----------------|----------------|----------------|----------------|----------------|----------------|----------|
| CK1113 | .100 (2.54) | .135 (3.43) | .135 (3.43) | .115 (2.92) | .140 (3.56) | .070 (1.78) | .150 (3.81) | .070 (1.78) | 1.2 |

Dimensions are in inches (mm). Tolerances: 2 Pl. $\pm .03$; 3Pl. $\pm .015$

Notes:

1. Case material: Nickel-Silver alloy.
2. Base: Printed wiring laminate.
3. Termination finish:

For RoHS Case Styles: 3-5 μ inch (.08-.13 microns) Gold over 120-240 μ inch (3.05-6.10 microns) Nickel plate.
All models, (+) suffix.

Mini-Circuits
ISO 9001 ISO 14001 CERTIFIED

ALL NEW
minicircuits.com

P.O. Box 350166, Brooklyn, New York 11235-0003 (718) 934-4500 Fax (718) 332-4661 For detailed performance specs & shopping online see Mini-Circuits web site



The Design Engineers Search Engine Provides ACTUAL Data Instantly From MINI-CIRCUITS At: www.minicircuits.com

RF/IF MICROWAVE COMPONENTS

Tape & Reel Packaging TR-F37



| Tape Width, mm | Device Cavity Pitch, mm | Reel Size, inches | Devices per Reel | |
|----------------|-------------------------|-------------------|-------------------------------------|-----|
| 24 | 16 | 7 | Small quantity standards (see note) | 10 |
| | | | | 20 |
| | | | | 50 |
| | | | | 100 |
| | | 13 | Standard | 200 |
| 500 | | | | |

Note: Please consult individual model data sheet to determine device per reel availability.

Mini-Circuits carrier tape materials provide protection from ESD (Electro-Static Discharge) during handling and transportation. Tapes are static dissipative and comply with industry standards EIA-481/EIA-541.

Go to: www.minicircuits.com/pages/pdfs/tape.pdf



INTERNET <http://www.minicircuits.com>

P.O. Box 350166, Brooklyn, New York 11235-0003 (718) 934-4500 Fax (718) 332-4661

Distribution Centers NORTH AMERICA 800-654-7949 • 417-335-5935 • Fax 417-335-5945 • EUROPE 44-1252-832600 • Fax 44-1252-837010

Mini-Circuits ISO 9001 & ISO 14001 Certified

THIRD ANGLE PROJECTION



REVISIONS

| REV | ECN No. | DESCRIPTION | DATE | DR | AUTH |
|-----|---------|---------------------------|----------|-----|------|
| E | M105563 | ADDED "r1" PIN CONNECTION | 06/02/06 | MMG | DJ |
| F | M105640 | CORRECTED NOTE 2 | 06/08/06 | MMG | MM |
| G | M124395 | ADDED "RAMP" | 09/09 | EM | HH |
| G | R77589 | ADDED "RAMP" | 09/09 | EM | HH |

SUGGESTED MOUNTING CONFIGURATION FOR CK605 CASE STYLE, "kg/rl/16AM01" PIN CONNECTION



NOTES:

1. TRACE WIDTH IS SHOWN FOR FR4 WITH DIELECTRIC THICKNESS .030" ± .002"; COPPER: 1/2 OZ. EACH SIDE. FOR OTHER MATERIALS TRACE WIDTH MAY NEED TO BE MODIFIED.
2. BOTTOM SIDE OF THE BOTTOM IS CONTINUOUS GROUND PLANE.



DENOTES PCB COPPER LAYOUT WITH SMOBC (SOLDER MASK OVER BARE COPPER)

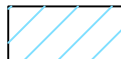

DENOTES COPPER LAND PATTERN FREE OF SOLDER MASK

| | | |
|----------------------------|-------------|----------|
| UNLESS OTHERWISE SPECIFIED | INITIALS | DATE |
| DIMENSIONS ARE IN INCHES | DRAWN AV | 08/07/00 |
| TOLERANCES ON: | CHECKED SK | 08/08/00 |
| 2 PL DECIMALS ± | APPROVED DB | 08/08/00 |
| 3 PL DECIMALS ± .005 | | |
| ANGLES ± | | |
| FRACTIONS ± | | |

 **Mini-Circuits®** 13 Neptune Avenue
Brooklyn NY 11235

PL,kg/rl/16AM01,CK605,ROS/LAVI/RAMP

| | | | |
|------------------|---------------------|--------------------------|-----------|
| SIZE A | CODE IDENT 15542 | DRAWING NO: 98-PL-012 | REV: G |
| FILE: 98PL012 | SCALE: 5:1 | SHEET: 1 OF 1 | |

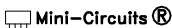
 Mini-Circuits®
THIS DOCUMENT AND ITS CONTENTS ARE THE PROPERTY OF MINI-CIRCUITS. EXCEPT FOR USE EXPRESSLY GRANTED, IN WRITING, TO ITS VENDORS, VENDEE AND THE UNITED STATES GOVERNMENT, MINI-CIRCUITS RESERVES ALL PROPRIETARY DESIGN, USE, MANUFACTURING AND REPRODUCTION RIGHTS THERETO. THESE CONTENTS SHALL NOT BE USED, DUPLICATED OR DISCLOSED TO ANY OUTSIDE PARTY, IN WHOLE OR IN PART, WITHOUT WRITTEN PERMISSION OF MINI-CIRCUITS.

Evaluation Board and Circuit



Schematic Diagram

Notes:

1. SMA Female connectors.
2. PCB Material: Rogers R04350 or equivalent,
Dielectric Constant=3.5, Thickness=.030 inch.

 **Mini-Circuits®**

All Mini-Circuits products are manufactured under exacting quality assurance and control standards, and are capable of meeting published specifications after being subjected to any or all of the following physical and environmental test.

| Specification | Test/Inspection Condition | Reference/Spec |
|--------------------------------|---|--|
| Operating Temperature | -55° to 85°C Ambient Environment | Individual Model Data Sheet |
| Storage Temperature | -55° to 100° C Ambient Environment | Individual Model Data Sheet |
| Humidity | 90 to 95% RH, 240 hours, 50°C | MIL-STD-202, Method 103, Condition A, Except 50°C and end-point electrical test done within 12 hours |
| Thermal Shock | -55° to 100°C, 100 cycles | MIL-STD-202, Method 107, Condition A-3, except +100°C |
| Solder Reflow Heat | Sn-Pb Eutectic Process: 225°C peak Pb-Free Process, 245°C peak | J-STD-020, Table 4-1, 4-2 and 5-2, Figure 5-1 |
| Solderability | 10X Magnification | J-STD-002, Para 4.2.5, Test S, 95% Coverage |
| Vibration (High Frequency) | 20g peak, 20-2000 Hz, 4 times in each of three axes (total 12) | MIL-STD-883, Method 2007.3, Condition A |
| Mechanical Shock | 50g, 11 ms, 1/2-sine, 18 shocks: 3 each direction, each of 3 axes | MIL-STD-202, Method 213, Condition A |
| Marking Resistance to Solvents | Isopropyl alcohol + mineral spirits at 25°C; terpene defluxer at 25°C; distilled water + proylene glycol monomethyl ether + monoethanolamine at 63°C to 70°C | MIL-STD-202, Method 215 |