

Surface Mount **NON-CATALOG** Power Splitter/Combiner

SBB-2-23

2 Way-0° 50Ω 2000 to 2300 MHz



CASE STYLE: SM31

Maximum Ratings

Operating Temperature	-40°C to 85°C
Storage Temperature	-55°C to 100°C
Power Input (as a splitter)	10W max.
Internal Dissipation	0.25W max.

Permanent damage may occur if any of these limits are exceeded.

Pin Connections

SUM PORT	2
PORT 1	6
PORT 2	4
GROUND	1,3,5

Outline Drawing

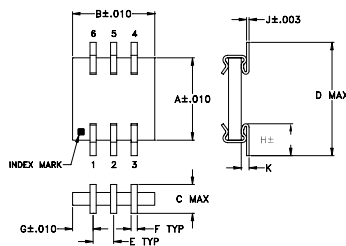

PCB Land Pattern

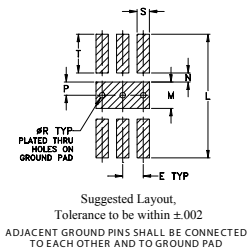

Outline Dimensions (inch/mm)

A	B	C	D	E	F	G	H	J	K	
.200	.200	.070	.275	.050	.015	.050	.085	.006	.019	
5.08	5.08	1.78	6.99	1.27	0.38	1.27	2.16	0.15	0.48	
L	M	N	P	Q	R	S	T		wt	
.300	.064	.022	.032	—	.014	.030	.094		grams	
7.62	1.63	0.56	0.81	—	0.36	0.76	2.39		0.1	

Demo Board MCL P/N: TB-156 Suggested PCB Layout (PL-003)

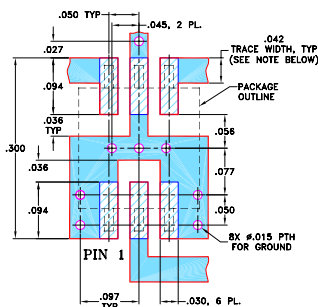

- NOTES:**
- TRACE WIDTH IS SHOWN FOR ROGERS RO4350B WITH DIELECTRIC THICKNESS .020" ± .0015"; COPPER: 1/2 OZ. EACH SIDE. FOR OTHER MATERIALS TRACE WIDTH MAY NEED TO BE MODIFIED.
 - BOTTOM SIDE OF THE PCB IS CONTINUOUS GROUND PLANE.
 - Denotes PCB COPPER LAYOUT WITH SMOBC (SOLDER MASK OVER BARE COPPER)
 - Denotes COPPER LAND PATTERN FREE OF SOLDER MASK

Notes

- Performance and quality attributes and conditions not expressly stated in this specification document are intended to be excluded and do not form a part of this specification document.
- Electrical specifications and performance data contained in this specification document are based on Mini-Circuit's applicable established test performance criteria and measurement instructions.
- The parts covered by this specification document are subject to Mini-Circuit's standard limited warranty and terms and conditions (collectively, "Standard Terms"); Purchasers of this part are entitled to the rights and benefits contained therein. For a full statement of the Standard Terms and the exclusive rights and remedies thereunder, please visit Mini-Circuit's website at www.minicircuits.com/MCLStore/terms.jsp

Features

- very stable performance over temp. range
- excellent insertion loss, 0.6 dB typ.
- excellent isolation, 24 dB typ.
- solder plated leads for excellent solderability and strain relief
- small size, 0.2"X0.275"X0.07"
- very low cost
- aqueous washable
- protected by U.S Patent, 6,819,202

Applications

- satellite communications
- mobile radio

Electrical Specifications

FREQ. RANGE (MHz)	ISOLATION (dB)		INSERTION LOSS ¹ (dB) ABOVE 3.0 dB		PHASE UNBALANCE (Degrees)	AMPLITUDE UNBALANCE (dB)
	Typ.	Min.	Typ.	Max.	Max.	Max.
$f_c - f_u$						
2000-2300	24	17	0.6	1.0	3.0	0.3
2100-2200	25	18	0.5	0.9	3.0	0.3

1. Includes test fixture losses

Typical Performance Data

Frequency (MHz)	Total Loss ¹ (dB)		Amplitude Unbalance (dB)	Isolation (dB)	Phase Unbalance (deg.)	VSWR S	VSWR 1	VSWR 2
	S-1	S-2						
2000.00	3.55	3.66	0.10	21.03	0.34	1.29	1.06	1.06
2020.00	3.55	3.64	0.10	21.14	0.42	1.27	1.06	1.05
2040.00	3.55	3.64	0.09	21.19	0.49	1.25	1.06	1.04
2060.00	3.56	3.65	0.09	21.28	0.54	1.24	1.06	1.03
2080.00	3.55	3.65	0.10	21.29	0.37	1.23	1.07	1.02
2100.00	3.57	3.64	0.07	21.29	0.37	1.22	1.08	1.02
2120.00	3.59	3.64	0.05	21.27	0.52	1.21	1.10	1.03
2140.00	3.60	3.65	0.06	21.28	0.66	1.20	1.11	1.04
2160.00	3.57	3.65	0.08	21.22	0.75	1.20	1.12	1.05
2180.00	3.56	3.63	0.06	21.17	0.52	1.20	1.13	1.06
2200.00	3.60	3.63	0.04	21.11	0.51	1.19	1.15	1.07
2220.00	3.66	3.67	0.01	21.09	0.75	1.20	1.17	1.08
2240.00	3.66	3.68	0.02	21.04	0.96	1.20	1.18	1.10
2280.00	3.59	3.63	0.03	20.85	0.67	1.21	1.22	1.12
2300.00	3.68	3.67	0.01	20.83	0.73	1.22	1.23	1.14

1. Total Loss = Insertion Loss + 3dB splitter loss.

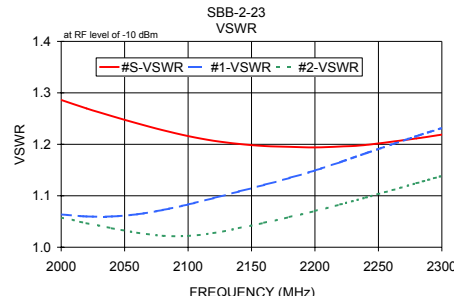
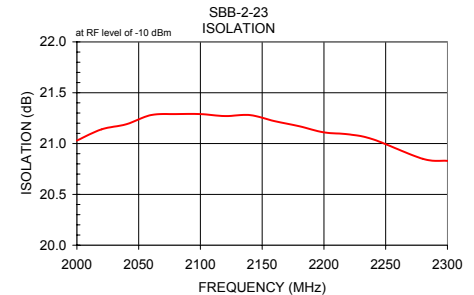
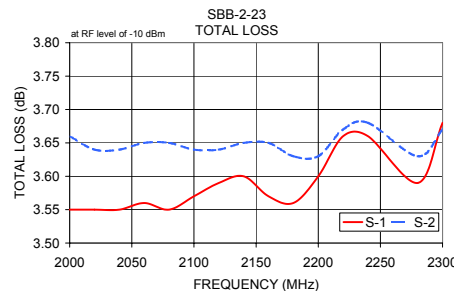

electrical schematic

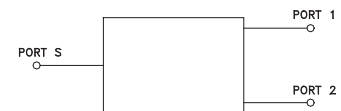

2 Way-0° Power Splitter/Combiner

SBB-2-23

Typical Performance Data

FREQUENCY (MHz)	TOTAL LOSS ¹		AMPLITUDE UNBALANCE (dB)	ISOLATION (dB) 1-2	PHASE UNBALANCE (deg.)	FREQUENCY (MHz)	VSWR (:1)		
	(dB)						S	1	2
	S-1	S-2							
2000.00	3.55	3.66	0.10	21.03	0.34	2000.00	1.29	1.06	1.06
2005.00	3.56	3.64	0.09	21.06	0.32	2005.00	1.28	1.06	1.06
2010.00	3.55	3.64	0.09	21.08	0.38	2010.00	1.28	1.06	1.05
2015.00	3.55	3.64	0.09	21.10	0.41	2015.00	1.27	1.06	1.05
2020.00	3.55	3.64	0.10	21.14	0.42	2020.00	1.27	1.06	1.05
2025.00	3.56	3.65	0.09	21.17	0.45	2025.00	1.27	1.06	1.04
2030.00	3.55	3.65	0.10	21.18	0.46	2030.00	1.26	1.06	1.04
2035.00	3.55	3.64	0.09	21.19	0.43	2035.00	1.26	1.06	1.04
2040.00	3.55	3.64	0.09	21.19	0.49	2040.00	1.25	1.06	1.04
2045.00	3.55	3.64	0.09	21.22	0.43	2045.00	1.25	1.06	1.03
2050.00	3.55	3.65	0.10	21.24	0.52	2050.00	1.25	1.06	1.03
2060.00	3.56	3.65	0.09	21.28	0.54	2060.00	1.24	1.06	1.03
2070.00	3.55	3.65	0.09	21.28	0.48	2070.00	1.23	1.07	1.02
2080.00	3.55	3.65	0.10	21.29	0.37	2080.00	1.23	1.07	1.02
2090.00	3.56	3.65	0.09	21.30	0.36	2090.00	1.22	1.08	1.02
2100.00	3.57	3.64	0.07	21.29	0.37	2100.00	1.22	1.08	1.02
2110.00	3.58	3.64	0.06	21.28	0.38	2110.00	1.21	1.09	1.02
2120.00	3.59	3.64	0.05	21.27	0.52	2120.00	1.21	1.10	1.03
2130.00	3.60	3.65	0.05	21.27	0.63	2130.00	1.20	1.10	1.03
2140.00	3.60	3.65	0.06	21.28	0.66	2140.00	1.20	1.11	1.04
2150.00	3.58	3.66	0.07	21.25	0.76	2150.00	1.20	1.11	1.04
2160.00	3.57	3.65	0.08	21.22	0.75	2160.00	1.20	1.12	1.05
2170.00	3.55	3.64	0.09	21.19	0.62	2170.00	1.20	1.13	1.05
2180.00	3.56	3.63	0.06	21.17	0.52	2180.00	1.20	1.13	1.06
2190.00	3.57	3.63	0.05	21.13	0.44	2190.00	1.19	1.14	1.06
2200.00	3.60	3.63	0.04	21.11	0.51	2200.00	1.19	1.15	1.07
2210.00	3.63	3.65	0.02	21.10	0.61	2210.00	1.19	1.16	1.08
2220.00	3.66	3.67	0.01	21.09	0.75	2220.00	1.20	1.17	1.08
2230.00	3.67	3.68	0.01	21.08	0.86	2230.00	1.20	1.17	1.09
2240.00	3.66	3.68	0.02	21.04	0.96	2240.00	1.20	1.18	1.10
2250.00	3.63	3.67	0.04	21.00	0.95	2250.00	1.20	1.19	1.10
2255.00	3.62	3.66	0.04	20.96	0.92	2255.00	1.20	1.19	1.11
2260.00	3.59	3.65	0.06	20.95	0.81	2260.00	1.20	1.20	1.11
2265.00	3.58	3.64	0.06	20.90	0.75	2265.00	1.21	1.20	1.11
2270.00	3.58	3.63	0.05	20.88	0.73	2270.00	1.21	1.21	1.12
2275.00	3.58	3.62	0.04	20.86	0.73	2275.00	1.21	1.21	1.12
2280.00	3.59	3.63	0.03	20.85	0.67	2280.00	1.21	1.22	1.12
2285.00	3.61	3.64	0.03	20.84	0.67	2285.00	1.21	1.22	1.13
2290.00	3.63	3.64	0.01	20.84	0.70	2290.00	1.21	1.22	1.13
2295.00	3.65	3.65	0.00	20.82	0.69	2295.00	1.22	1.23	1.13
2300.00	3.68	3.67	0.01	20.83	0.73	2300.00	1.22	1.23	1.14

¹Total Loss = Insertion Loss + 3dB Splitter Loss



Typical Performance Curves

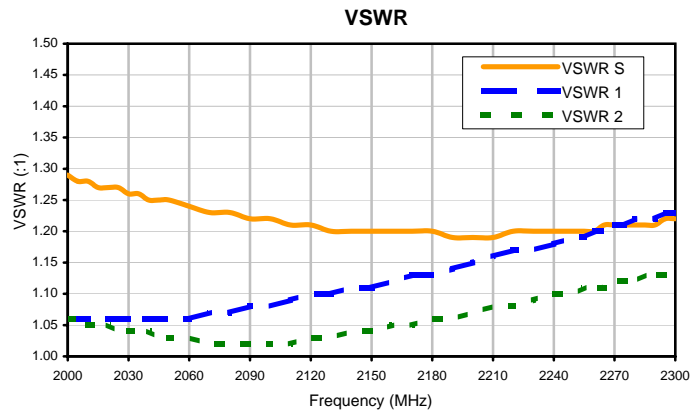
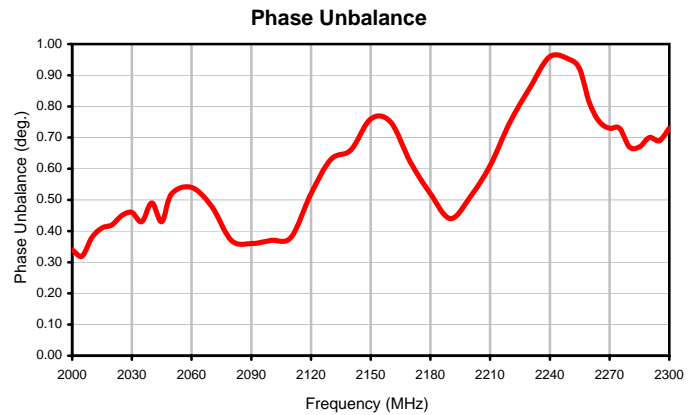
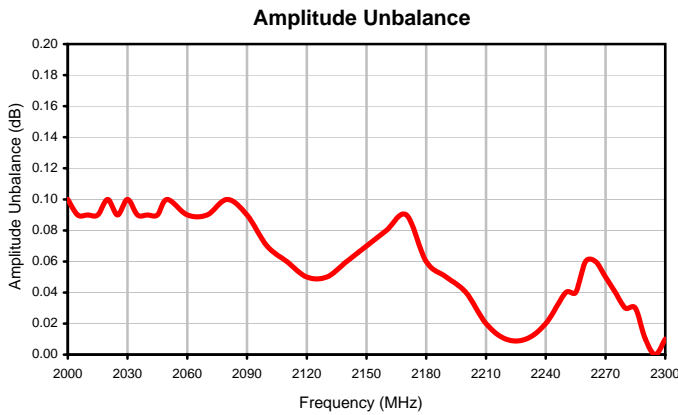
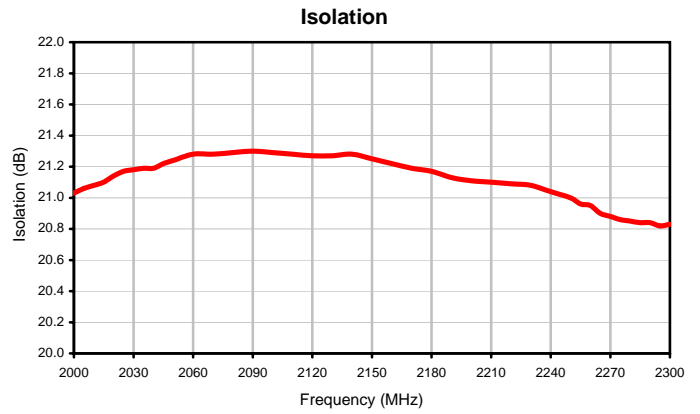
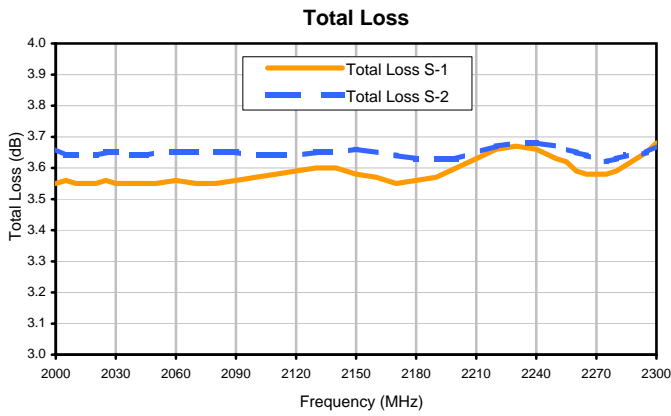

Case Style

SM31

SM31

Outline Dimensions

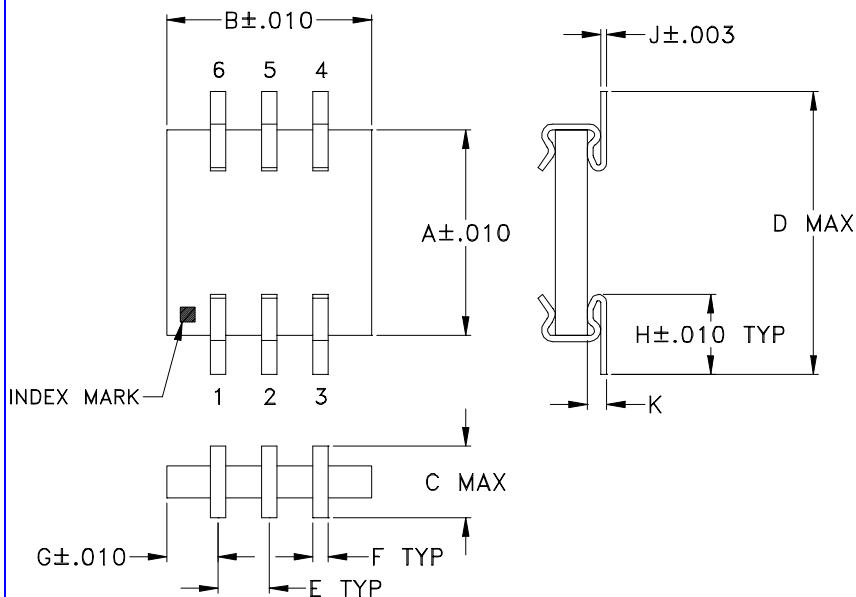

PCB Land Pattern

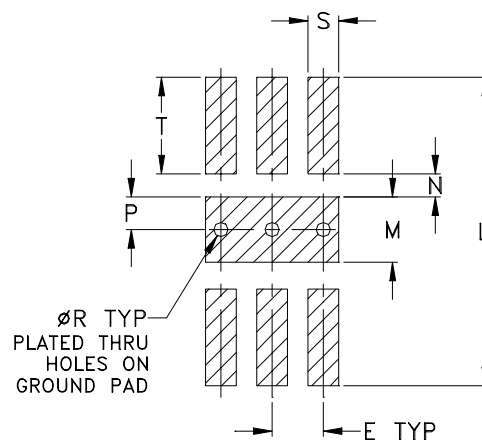

Suggested Layout,
Tolerance to be within $\pm .002$

ADJACENT GROUND PINS SHALL BE CONNECTED
TO EACH OTHER AND TO GROUND PAD

CASE #	A	B	C	D	E	F	G	H	J	K	L	M	N	P
SM31	.200 (5.08)	.200 (5.08)	.070 (1.78)	.275 (6.99)	.050 (1.27)	.015 (0.38)	.050 (1.27)	.085 (2.16)	.006 (0.15)	.019 (0.48)	.300 (7.62)	.064 (1.63)	.022 (0.56)	.032 (0.81)

CASE #	Q	R	S	T	WT. GRAM
SM31	--	.014 (0.36)	.030 (0.76)	.094 (2.39)	0.1

Dimensions are in inches (mm). Tolerances: $\pm .005$

Notes:

- Case material: Ceramic.
- Termination finish:
For RoHS Case Styles: Tin plate over Nickel plate.
For RoHS-5 Case Styles: Tin-Lead plate.

Mini-Circuits

INTERNET <http://www.minicircuits.com>

P.O. Box 350166, Brooklyn, New York 11235-0003 (718) 934-4500 Fax (718) 332-4661

Distribution Centers NORTH AMERICA 800-654-7949 • 417-335-5935 • Fax 417-335-5945 • EUROPE 44-1252-832600 • Fax 44-1252-837010

Mini-Circuits ISO 9001 & ISO 14001 Certified

Tape & Reel Packaging TR-F34



Tape Width, mm	Device Cavity Pitch, mm	Reel Size, inches	Devices per Reel see note	
16	12	7	Small quantity standard (see note)	20
				50
				100
				200
		13	Standard	500
				1000

Note: Availability of small reel quantity varies by model.
Refer to pricing and availability on individual model dashboard.

Mini-Circuits carrier tape materials provide protection from ESD (Electro-Static Discharge) during handling and transportation. Tapes are static dissipative and comply with industry standards EIA-481/EIA-541.

Go to: www.minicircuits.com/pages/pdfs/tape.pdf



INTERNET <http://www.minicircuits.com>

P.O. Box 350166, Brooklyn, New York 11235-0003 (718) 934-4500 Fax (718) 332-4661

Distribution Centers NORTH AMERICA 800-654-7949 • 417-335-5935 • Fax 417-335-5945 • EUROPE 44-1252-832600 • Fax 44-1252-837010

Mini-Circuits ISO 9001 & ISO 14001 Certified

THIRD ANGLE PROJECTION

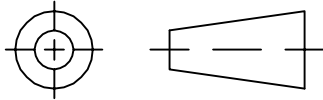

REVISIONS

REV	ECN No.	DESCRIPTION	DATE	DR	AUTH
OR	M71387	NEW RELEASE	04/00	MMG	DB
A	M82575	UPDATED DRAWING	08/08/02	AV	HY
B	M102713	UPDATED NOTES	01/12/06	GF	IL

**SUGGESTED MOUNTING CONFIGURATION
FOR SM31 CASE STYLE, "mu" PIN CONNECTION**

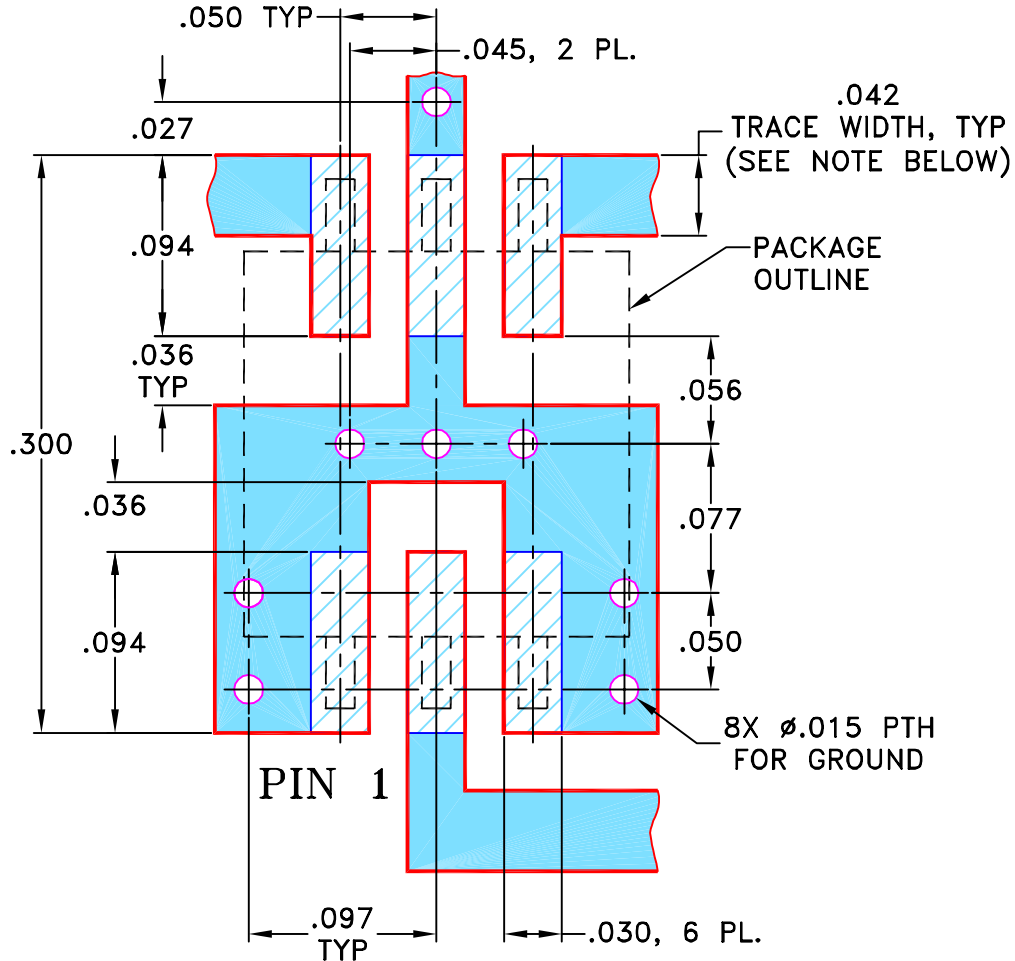

NOTES: 1. TRACE WIDTH IS SHOWN FOR ROGERS R04350B WITH DIELECTRIC THICKNESS .020" ± .0015"; COPPER: 1/2 OZ. EACH SIDE. FOR OTHER MATERIALS TRACE WIDTH MAY NEED TO BE MODIFIED.

2. BOTTOM SIDE OF THE PCB IS CONTINUOUS GROUND PLANE.



DENOTES PCB COPPER LAYOUT WITH SMOBC (SOLDER MASK OVER BARE COPPER)



DENOTES COPPER LAND PATTERN FREE OF SOLDER MASK

UNLESS OTHERWISE SPECIFIED	INITIALS	DATE
DIMENSIONS ARE IN INCHES TOLERANCES ON: 2 PL DECIMALS ± 3 PL DECIMALS ± .005 ANGLES ± FRACTIONS ±	DRAWN	MMG 04/12/00
	CHECKED	WP 04/27/00
	APPROVED	DB 04/27/00



Mini-Circuits®

13 Neptune Avenue
Brooklyn NY 11235

PL, mu, SM31, SBB, TB-156

Mini-Circuits®
THIS DOCUMENT AND ITS CONTENTS ARE THE PROPERTY OF MINI-CIRCUITS. EXCEPT FOR USE EXPRESSLY GRANTED, IN WRITING, TO ITS VENDORS, VENDEE AND THE UNITED STATES GOVERNMENT, MINI-CIRCUITS RESERVES ALL PROPRIETARY DESIGN, USE, MANUFACTURING AND REPRODUCTION RIGHTS THERETO. THESE CONTENTS SHALL NOT BE USED, DUPLICATED OR DISCLOSED TO ANY OUTSIDE PARTY, IN WHOLE OR IN PART, WITHOUT WRITTEN PERMISSION OF MINI-CIRCUITS.

SIZE A	CODE IDENT 15542	DRAWING NO: 98-PL-003	REV: B
FILE: 98PL003	SCALE: 10:1	SHEET: 1 OF 1	

Evaluation Board and Circuit

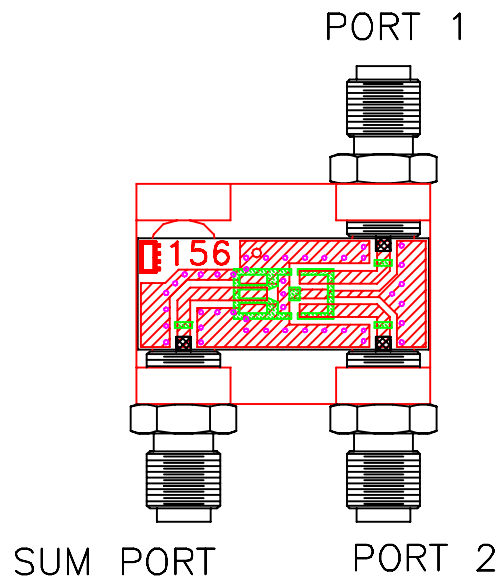

TB-156

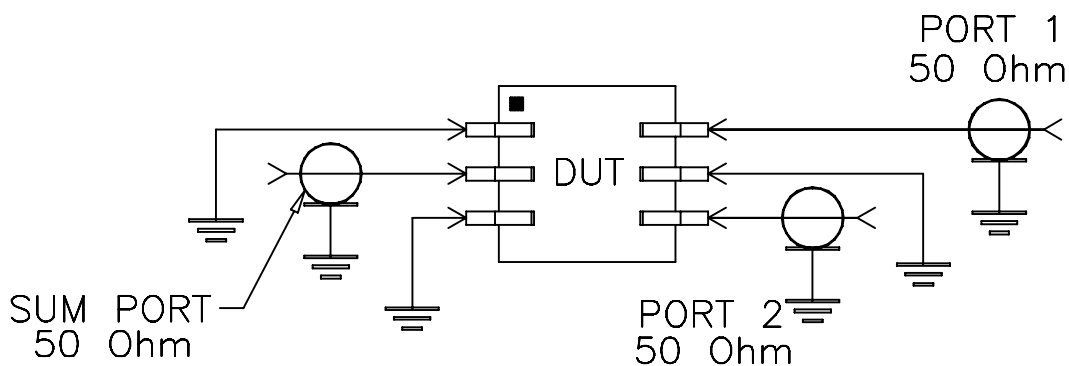

Schematic Diagram

Notes:

1. SMA Female connectors.
2. PCB Material: Rogers R04350 or equivalent,
Dielectric Constant=3.5, Thickness=.020 inch.

 Mini-Circuits®

All Mini-Circuits products are manufactured under exacting quality assurance and control standards, and are capable of meeting published specifications after being subjected to any or all of the following physical and environmental test.

Specification	Test/Inspection Condition	Reference/Spec
Operating Temperature	-40° to 85°C Ambient Environment	Individual Model Data Sheet
Storage Temperature	-55° to 100° C Ambient Environment	Individual Model Data Sheet
Humidity	90 to 95% RH, 240 hours, 50°C	MIL-STD-202, Method 103, Condition A, Except 50°C and end-point electrical test done within 12 hours
Thermal Shock	-55° to 100°C, 100 cycles	MIL-STD-202, Method 107, Condition A-3, except +100°C
Solder Reflow Heat	Sn-Pb Eutetic Process: 225°C peak Pb-Free Process 245° - 250°C peak	J-STD-020, Table 4-1, 4-2 and 5-2, Figure 5-1
Solderability	10X Magnification	J-STD-002, 95% Coverage
Vibration (High Frequency)	20g peak, 10-2000 Hz, 12 times in each of three perpendicular directions (total 36)	MIL-STD-202, Method 204, Condition D
Mechanical Shock	50g, 11 ms, 1/2-sine, 18 shocks: 3 each direction, each of 3 axes	MIL-STD-202, Method 213, Condition A
Marking Resistance to Solvents	Isopropyl alcohol + mineral spirits at 25°C; terpene defluxer at 25°C; distilled water + proylene glycol monomethyl ether + monoethanolamine at 63°C to 70°C	MIL-STD-202, Method 215