

# Power Splitter/Combiner

SBD-4-25

4 Way-0° 50Ω 1800 to 2600 MHz



CASE STYLE: SM34

## Maximum Ratings

Operating Temperature	-40°C to 85°C
Storage Temperature	-55°C to 100°C
Power Input (as a splitter)	10W max.
Internal Dissipation	0.375W max.

Permanent damage may occur if any of these limits are exceeded.

## Pin Connections

SUM PORT	4
PORT 1	8
PORT 2	10
PORT 3	12
PORT 4	14
GROUND	2,3,5,6,9,13
NOT USED	1,7,11

## Outline Drawing

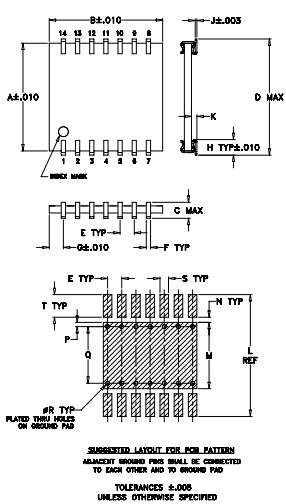

## Outline Dimensions (inch/mm)

A	B	C	D	E	F	G	H	J
.380	.400	.070	.420	.050	.015	.050	.060	.006
9.65	10.16	1.78	10.67	1.27	0.38	1.27	1.52	0.15
K	L	M	N	P	Q	R	S	T
.020	.430	.234	.018	.015	.200	.014	.030	.080
0.51	10.92	5.94	0.46	0.38	5.08	0.36	0.76	2.03
								0.3

## Demo Board MCL P/N: TB-85 Suggested PCB Layout (PL-142)

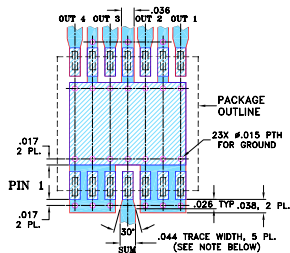

NOTE: 1. TRACE WIDTH IS SHOWN FOR ROGERS RO4350B WITH DIELECTRIC THICKNESS .020 ± .0015; COPPER: 1/2 OZ. EACH SIDE. FOR OTHER MATERIALS TRACE WIDTH MAY NEED TO BE MODIFIED.  
 2. BOTTOM SIDE OF THE PCB IS CONTINUOUS GROUND PLANE.

■ DENOTES PCB COPPER LAYOUT  
 ▨ DENOTES COPPER LAND PATTERN FREE OF SOLDERMASK

### Notes

A. Performance and quality attributes and conditions not expressly stated in this specification document are intended to be excluded and do not form a part of this specification document.  
 B. Electrical specifications and performance data contained in this specification document are based on Mini-Circuit's applicable established test performance criteria and measurement instructions.  
 C. The parts covered by this specification document are subject to Mini-Circuit's standard limited warranty and terms and conditions (collectively, "Standard Terms"); Purchasers of this part are entitled to the rights and benefits contained therein. For a full statement of the Standard Terms and the exclusive rights and remedies thereunder, please visit Mini-Circuit's website at [www.minicircuits.com/WCLStore/terms.jsp](http://www.minicircuits.com/WCLStore/terms.jsp)

## Features

- wideband frequency, 1800 to 2600 MHz
- high isolation, 20 dB typ.
- good input port matching VSWR, 1.26 typ.
- good output port matching VSWR, 1.26 typ.
- high power handling
- aqueous washable
- protected by U.S Patent 6,819,202

## Applications

- PCS
- ISM
- WLAN
- VMTS

## Electrical Specifications

FREQ. RANGE (MHz)	ISOLATION (dB)		INSERTION LOSS (dB) ABOVE 6.0 dB		PHASE UNBALANCE (Degrees)	AMPLITUDE UNBALANCE (dB)	
	Typ.	Min.	Typ.	Max.	Max.	Typ.	Max.
$f_c - f_u$							
1800-2600	20	12	1.0	1.9	8	0.2	0.7
1800-2000	18	12	0.9	1.4	6	0.15	0.4
2100-2200	21	15	0.9	1.4	6	0.15	0.4
2200-2400	22	15	1.0	1.6	7	0.15	0.6
2400-2500	22	16	1.0	1.8	7	0.25	0.7

## Typical Performance Data

Freq. (MHz)	Total Loss <sup>1</sup> (dB)				Amp. Unbal. (dB)	Isolation (dB)			Phase Unbal. (deg.)	VSWR S	VSWR 1	VSWR 2	VSWR 3	VSWR 4
	S-1	S-2	S-3	S-4		1-2	2-3	3-4						
1800.00	6.83	6.80	6.92	6.82	0.13	17.65	18.21	17.86	2.17	1.35	1.20	1.10	1.13	1.20
1850.00	6.83	6.80	6.91	6.84	0.12	18.45	18.48	18.58	2.43	1.35	1.21	1.11	1.15	1.21
1900.00	6.85	6.83	6.96	6.86	0.13	19.29	18.86	19.40	2.26	1.35	1.23	1.12	1.16	1.22
2000.00	6.87	6.83	6.96	6.86	0.13	21.08	19.81	20.98	2.35	1.32	1.25	1.14	1.19	1.23
2050.00	6.93	6.89	7.05	6.96	0.16	22.04	20.51	21.82	2.09	1.30	1.26	1.15	1.20	1.24
2100.00	6.89	6.83	6.97	6.88	0.14	22.87	21.19	22.42	2.52	1.29	1.28	1.15	1.21	1.24
2150.00	6.99	6.92	7.09	7.02	0.17	23.76	22.17	23.15	2.09	1.27	1.28	1.16	1.22	1.25
2200.00	6.93	6.87	7.00	6.92	0.13	24.39	23.19	23.45	2.58	1.26	1.29	1.17	1.23	1.25
2250.00	7.01	6.94	7.11	7.03	0.17	24.89	24.52	23.75	2.19	1.25	1.29	1.17	1.24	1.25
2300.00	6.98	6.90	7.05	6.99	0.15	25.03	26.03	23.63	2.49	1.25	1.29	1.18	1.24	1.25
2400.00	7.02	6.93	7.08	7.07	0.15	24.61	29.63	22.99	2.67	1.28	1.29	1.19	1.25	1.24
2450.00	7.15	7.04	7.22	7.15	0.18	24.16	30.97	22.58	2.43	1.31	1.30	1.19	1.24	1.23
2500.00	7.07	6.96	7.11	7.13	0.17	23.40	30.43	21.81	2.90	1.35	1.29	1.20	1.24	1.23
2550.00	7.25	7.12	7.32	7.28	0.20	22.75	28.84	21.33	2.43	1.38	1.29	1.20	1.23	1.21
2600.00	7.14	7.02	7.17	7.20	0.18	21.87	26.73	20.46	3.20	1.43	1.28	1.21	1.23	1.21

1. Total Loss = Insertion Loss + 6dB splitter loss.

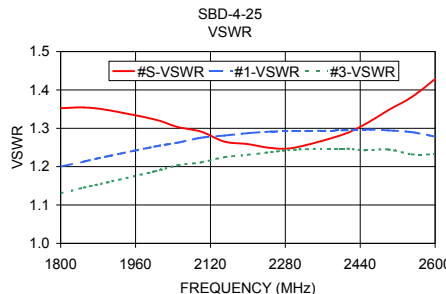
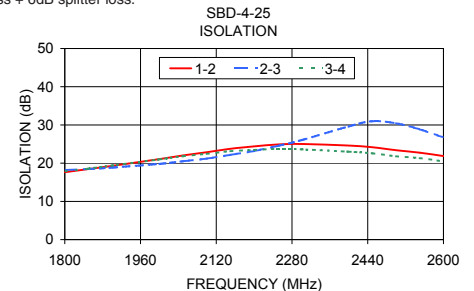
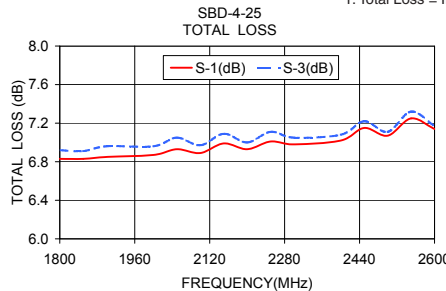

## electrical schematic



# 4 Way-0° Power Splitter/Combiner

# SBD-4-25

## Typical Performance Data

TEST CONDITIONS: INPUT POWER = 0dBm @Temperature = +25°C

FREQ. (MHz)	TOTAL LOSS <sup>1</sup> (dB)				AMP. UNBAL. (dB)	PHASE UNBAL. (deg.)	ISOLATION (dB)			VSWR (:1)				
	S-1	S-2	S-3	S-4			1-2	2-3	3-4	S	1	2	3	4
300	7.99	7.92	7.96	7.96	0.07	0.25	10.32	10.34	6.24	3.58	2.56	2.54	2.55	2.56
400	7.93	7.85	7.88	7.90	0.08	0.25	11.36	11.41	6.06	3.45	2.20	2.17	2.18	2.21
500	7.84	7.75	7.77	7.81	0.09	0.26	12.35	12.45	6.11	3.29	1.93	1.89	1.90	1.94
600	7.72	7.63	7.64	7.71	0.09	0.13	13.28	13.44	6.32	3.11	1.73	1.67	1.68	1.73
700	7.58	7.49	7.49	7.58	0.09	0.22	14.14	14.36	6.65	2.90	1.57	1.51	1.52	1.56
800	7.42	7.33	7.32	7.43	0.10	0.31	14.95	15.22	7.08	2.68	1.44	1.38	1.38	1.43
900	7.26	7.17	7.16	7.27	0.11	0.49	15.70	16.02	7.58	2.44	1.34	1.27	1.28	1.32
1000	7.09	6.99	6.99	7.09	0.10	0.66	16.43	16.75	8.15	2.20	1.25	1.20	1.19	1.24
1100	6.93	6.83	6.84	6.92	0.10	0.72	17.14	17.44	8.80	1.97	1.19	1.13	1.13	1.17
1200	6.79	6.69	6.71	6.77	0.11	0.85	17.86	18.09	9.53	1.75	1.14	1.09	1.08	1.12
1300	6.68	6.57	6.60	6.64	0.11	0.91	18.63	18.72	10.32	1.55	1.10	1.07	1.05	1.08
1400	6.60	6.49	6.54	6.56	0.11	1.07	19.48	19.38	11.15	1.38	1.07	1.06	1.03	1.05
1500	6.55	6.45	6.49	6.50	0.10	1.13	20.44	20.11	11.99	1.25	1.05	1.06	1.04	1.03
1550	6.54	6.43	6.48	6.49	0.10	1.15	20.98	20.53	12.42	1.20	1.05	1.07	1.05	1.02
1600	6.53	6.44	6.49	6.49	0.09	1.16	21.58	20.98	12.82	1.17	1.04	1.08	1.05	1.01
1650	6.54	6.45	6.50	6.50	0.08	1.21	22.22	21.49	13.22	1.17	1.03	1.09	1.07	1.01
1700	6.54	6.47	6.51	6.51	0.08	1.15	22.95	22.04	13.60	1.18	1.03	1.10	1.08	1.02
1750	6.56	6.49	6.53	6.52	0.07	1.26	23.75	22.68	13.97	1.21	1.03	1.11	1.09	1.03
1800	6.58	6.52	6.56	6.55	0.06	1.26	24.66	23.42	14.34	1.24	1.04	1.12	1.10	1.05
1850	6.60	6.55	6.58	6.58	0.05	1.38	25.67	24.26	14.71	1.28	1.04	1.14	1.11	1.06
1900	6.61	6.59	6.61	6.61	0.03	1.51	26.84	25.22	15.09	1.31	1.05	1.15	1.12	1.07
1950	6.63	6.61	6.64	6.64	0.03	1.62	28.20	26.35	15.51	1.34	1.06	1.15	1.13	1.09
2000	6.64	6.64	6.66	6.67	0.03	1.63	29.82	27.72	15.97	1.36	1.06	1.16	1.14	1.10
2050	6.66	6.67	6.68	6.70	0.04	1.69	31.80	29.39	16.49	1.37	1.07	1.17	1.15	1.11
2100	6.67	6.70	6.70	6.72	0.05	1.60	34.36	31.44	17.09	1.38	1.07	1.17	1.15	1.12
2150	6.68	6.71	6.71	6.73	0.05	1.63	38.01	34.27	17.78	1.38	1.08	1.17	1.15	1.12
2200	6.67	6.73	6.73	6.75	0.07	1.70	44.06	38.27	18.63	1.36	1.08	1.17	1.15	1.12
2250	6.67	6.74	6.72	6.74	0.07	1.76	53.55	44.05	19.65	1.34	1.07	1.16	1.14	1.12
2300	6.66	6.74	6.73	6.75	0.09	1.75	43.31	43.52	20.90	1.30	1.07	1.15	1.13	1.12
2350	6.65	6.74	6.73	6.76	0.11	1.76	37.86	37.95	22.45	1.26	1.06	1.14	1.13	1.11
2400	6.64	6.75	6.73	6.75	0.11	1.76	34.70	34.25	24.43	1.21	1.05	1.13	1.12	1.10
2450	6.64	6.75	6.73	6.75	0.12	1.86	32.37	31.68	26.94	1.15	1.03	1.12	1.11	1.09
2500	6.63	6.76	6.74	6.76	0.13	1.90	30.65	29.80	29.71	1.10	1.01	1.12	1.11	1.08
2550	6.64	6.78	6.76	6.78	0.14	1.97	29.33	28.36	30.63	1.08	1.01	1.13	1.13	1.08
2600	6.66	6.81	6.80	6.83	0.17	2.01	28.31	27.24	28.31	1.13	1.04	1.15	1.15	1.09
2650	6.70	6.86	6.85	6.88	0.18	2.00	27.50	26.44	25.33	1.21	1.07	1.19	1.19	1.11
2700	6.76	6.94	6.92	6.96	0.20	2.11	26.86	25.82	22.82	1.32	1.11	1.23	1.23	1.15
2750	6.85	7.04	7.01	7.06	0.22	2.23	26.36	25.39	20.82	1.46	1.15	1.29	1.28	1.20
2800	6.95	7.17	7.13	7.19	0.24	2.30	26.04	25.11	19.25	1.62	1.20	1.34	1.34	1.25
2850	7.10	7.33	7.28	7.36	0.26	2.42	25.79	25.01	17.99	1.79	1.25	1.41	1.41	1.31
2900	7.26	7.51	7.46	7.54	0.28	2.50	25.65	25.01	16.98	1.99	1.30	1.48	1.48	1.38
2950	7.45	7.72	7.66	7.75	0.30	2.64	25.60	25.14	16.18	2.21	1.36	1.55	1.55	1.45
3000	7.66	7.94	7.87	7.98	0.32	2.76	25.60	25.35	15.55	2.45	1.42	1.62	1.62	1.52
3100	8.11	8.43	8.34	8.45	0.34	2.83	25.80	26.02	14.72	2.97	1.54	1.76	1.77	1.66
3200	8.57	8.91	8.81	8.94	0.37	3.05	26.10	26.86	14.29	3.52	1.67	1.91	1.92	1.82
3300	8.99	9.32	9.23	9.35	0.36	3.09	26.48	27.98	14.27	3.99	1.81	2.04	2.06	1.96
3400	9.31	9.64	9.56	9.67	0.37	3.21	26.89	28.97	14.53	4.38	1.94	2.17	2.19	2.10
3500	9.50	9.81	9.75	9.86	0.36	3.28	27.19	29.84	15.13	4.56	2.07	2.28	2.32	2.24
3600	9.55	9.82	9.79	9.89	0.34	3.41	27.70	30.69	16.15	4.50	2.21	2.38	2.43	2.36
3700	9.44	9.66	9.66	9.76	0.31	3.53	28.23	31.24	17.73	4.22	2.33	2.46	2.53	2.46
3800	9.18	9.34	9.38	9.47	0.28	3.86	29.03	31.76	20.36	3.73	2.43	2.52	2.60	2.54
3900	8.80	8.91	8.95	9.06	0.26	3.94	30.51	32.51	25.55	3.09	2.51	2.55	2.64	2.58
4000	8.37	8.41	8.46	8.58	0.21	4.27	33.63	34.30	45.17	2.42	2.55	2.55	2.63	2.59
4100	8.00	7.98	8.01	8.17	0.19	4.43	40.99	39.37	23.69	1.81	2.56	2.52	2.60	2.56

<sup>1</sup> Total Loss = Insertion Loss+ 6dB Splitter Loss

REV. X2  
SBD-4-25  
100627  
Page 1 of 3



RF/MICROWAVE COMPONENTS • ISO 9001 ISO 14001 AS 9100 CERTIFIED • RoHS compliant  
P.O. Box 350166, Brooklyn, New York 11235-0006 (718) 934-4500 Fax (718) 332-4661



The Design Engineers Search Engine finds the model you need, Instantly • For detailed performance specs & shopping online see



# 4 Way-0° Power Splitter/Combiner

# SBD-4-25

## Typical Performance Data

TEST CONDITIONS: INPUT POWER = 0dBm @Temperature = -40°C

FREQ. (MHz)	TOTAL LOSS <sup>1</sup> (dB)				AMP. UNBAL. (dB)	PHASE UNBAL. (deg.)	ISOLATION (dB)			VSWR (:1)				
	S-1	S-2	S-3	S-4			1-2	2-3	3-4	S	1	2	3	4
300	7.95	7.87	7.92	7.91	0.08	0.25	10.24	10.26	6.19	3.63	2.59	2.57	2.59	2.60
400	7.88	7.79	7.82	7.83	0.09	0.32	11.27	11.32	6.01	3.49	2.24	2.20	2.22	2.24
500	7.78	7.69	7.71	7.75	0.09	0.47	12.25	12.34	6.05	3.34	1.96	1.91	1.93	1.96
600	7.64	7.57	7.56	7.63	0.09	0.42	13.17	13.32	6.27	3.16	1.75	1.69	1.71	1.75
700	7.49	7.43	7.40	7.50	0.10	0.38	14.00	14.23	6.58	2.95	1.58	1.53	1.53	1.58
800	7.33	7.26	7.23	7.34	0.11	0.31	14.79	15.08	6.99	2.73	1.45	1.39	1.39	1.44
900	7.14	7.08	7.05	7.16	0.11	0.41	15.54	15.87	7.47	2.48	1.34	1.29	1.28	1.33
1000	6.97	6.90	6.87	6.97	0.10	0.54	16.26	16.61	8.03	2.23	1.26	1.20	1.20	1.24
1100	6.81	6.73	6.72	6.80	0.10	0.49	16.97	17.30	8.66	2.00	1.19	1.14	1.13	1.17
1200	6.67	6.57	6.58	6.64	0.10	0.66	17.68	17.94	9.36	1.78	1.14	1.09	1.08	1.12
1300	6.55	6.44	6.47	6.50	0.12	0.76	18.43	18.56	10.13	1.58	1.10	1.06	1.05	1.08
1400	6.46	6.35	6.40	6.40	0.11	1.02	19.25	19.20	10.95	1.40	1.07	1.06	1.04	1.05
1500	6.41	6.30	6.34	6.34	0.11	1.23	20.17	19.91	11.78	1.27	1.06	1.06	1.05	1.03
1550	6.39	6.29	6.33	6.33	0.10	1.40	20.70	20.31	12.19	1.23	1.05	1.07	1.05	1.02
1600	6.38	6.29	6.33	6.32	0.10	1.50	21.27	20.74	12.59	1.20	1.04	1.08	1.06	1.02
1650	6.38	6.29	6.34	6.32	0.09	1.63	21.90	21.22	12.97	1.18	1.04	1.09	1.07	1.01
1700	6.38	6.30	6.34	6.32	0.08	1.75	22.60	21.76	13.35	1.19	1.04	1.10	1.08	1.02
1750	6.38	6.32	6.35	6.33	0.06	1.89	23.38	22.38	13.70	1.21	1.03	1.12	1.09	1.03
1800	6.40	6.35	6.37	6.36	0.04	1.96	24.27	23.09	14.05	1.24	1.04	1.13	1.10	1.04
1850	6.41	6.38	6.39	6.38	0.03	1.97	25.26	23.90	14.39	1.28	1.05	1.14	1.11	1.05
1900	6.42	6.41	6.41	6.41	0.01	2.05	26.42	24.85	14.74	1.31	1.05	1.15	1.12	1.07
1950	6.43	6.44	6.43	6.44	0.01	2.12	27.76	25.96	15.12	1.33	1.05	1.16	1.12	1.08
2000	6.44	6.47	6.44	6.47	0.02	2.14	29.33	27.27	15.55	1.36	1.05	1.17	1.13	1.09
2050	6.45	6.49	6.46	6.49	0.04	2.17	31.30	28.86	16.02	1.37	1.06	1.18	1.13	1.11
2100	6.46	6.51	6.47	6.51	0.05	2.09	33.77	30.83	16.58	1.37	1.06	1.18	1.13	1.12
2150	6.46	6.52	6.48	6.52	0.06	2.16	37.32	33.49	17.22	1.37	1.06	1.18	1.14	1.12
2200	6.46	6.53	6.49	6.52	0.07	2.21	43.25	37.01	17.98	1.35	1.07	1.17	1.14	1.12
2250	6.45	6.54	6.49	6.52	0.09	2.24	64.86	41.71	18.91	1.34	1.07	1.17	1.13	1.12
2300	6.45	6.54	6.50	6.53	0.09	2.24	43.99	42.10	20.05	1.31	1.08	1.16	1.13	1.11
2350	6.44	6.55	6.51	6.53	0.11	2.33	37.92	37.59	21.46	1.28	1.08	1.14	1.12	1.11
2400	6.43	6.55	6.49	6.52	0.12	2.36	34.43	33.99	23.22	1.23	1.07	1.13	1.11	1.10
2450	6.41	6.54	6.50	6.52	0.13	2.42	32.08	31.37	25.45	1.17	1.06	1.12	1.10	1.09
2500	6.40	6.55	6.50	6.53	0.15	2.52	30.36	29.51	28.03	1.12	1.05	1.12	1.10	1.08
2550	6.41	6.56	6.51	6.54	0.15	2.64	28.99	28.06	29.78	1.08	1.03	1.13	1.10	1.07
2600	6.41	6.58	6.53	6.57	0.17	2.64	27.92	26.93	28.59	1.10	1.00	1.14	1.12	1.07
2650	6.44	6.63	6.57	6.62	0.19	2.68	27.11	26.07	25.82	1.18	1.03	1.18	1.16	1.09
2700	6.49	6.68	6.63	6.69	0.21	2.75	26.43	25.44	23.21	1.29	1.07	1.22	1.21	1.13
2750	6.56	6.78	6.71	6.79	0.22	2.83	25.90	24.97	21.07	1.42	1.11	1.27	1.27	1.18
2800	6.66	6.89	6.83	6.90	0.23	2.85	25.53	24.68	19.41	1.58	1.17	1.33	1.33	1.23
2850	6.80	7.02	6.97	7.05	0.26	2.90	25.29	24.55	18.06	1.75	1.23	1.39	1.40	1.30
2900	6.96	7.20	7.15	7.23	0.27	2.92	25.15	24.54	17.00	1.95	1.30	1.46	1.48	1.36
2950	7.15	7.39	7.34	7.44	0.30	3.08	25.08	24.62	16.12	2.19	1.37	1.53	1.56	1.43
3000	7.37	7.62	7.57	7.67	0.31	3.16	25.09	24.81	15.45	2.44	1.44	1.61	1.66	1.50
3100	7.84	8.11	8.06	8.16	0.32	3.26	25.29	25.49	14.54	3.02	1.61	1.76	1.82	1.66
3200	8.30	8.58	8.53	8.63	0.33	3.45	25.63	26.38	14.10	3.60	1.75	1.91	2.00	1.82
3300	8.71	9.00	8.96	9.04	0.33	3.60	25.97	27.33	13.99	4.13	1.89	2.05	2.15	1.97
3400	9.03	9.33	9.28	9.38	0.34	3.84	26.30	28.22	14.15	4.58	1.99	2.19	2.28	2.11
3500	9.20	9.53	9.45	9.58	0.38	3.91	26.66	29.14	14.67	4.77	2.08	2.32	2.39	2.25
3600	9.22	9.56	9.47	9.55	0.34	3.78	26.98	29.94	15.55	4.72	2.18	2.43	2.47	2.38
3700	9.11	9.43	9.33	9.44	0.34	3.78	27.47	30.46	16.95	4.43	2.28	2.54	2.54	2.48
3800	8.85	9.14	9.04	9.14	0.30	3.61	28.03	30.59	19.20	3.95	2.37	2.61	2.60	2.56
3900	8.49	8.74	8.65	8.74	0.25	3.19	29.30	31.31	23.42	3.31	2.45	2.66	2.62	2.60
4000	8.06	8.23	8.16	8.26	0.20	3.10	31.80	32.73	37.45	2.63	2.53	2.65	2.63	2.60
4100	7.69	7.76	7.71	7.84	0.15	2.93	37.89	35.86	25.86	1.99	2.60	2.61	2.65	2.58

<sup>1</sup> Total Loss = Insertion Loss+ 6dB Splitter Loss



# 4 Way-0° Power Splitter/Combiner

# SBD-4-25

## Typical Performance Data

TEST CONDITIONS: INPUT POWER = 0dBm @Temperature = +85°C

FREQ. (MHz)	TOTAL LOSS <sup>1</sup> (dB)				AMP. UNBAL. (dB)	PHASE UNBAL. (deg.)	ISOLATION (dB)			VSWR (:1)				
	S-1	S-2	S-3	S-4			1-2	2-3	3-4	S	1	2	3	4
300	8.01	7.96	7.99	7.99	0.06	0.42	10.37	10.39	6.26	3.55	2.53	2.52	2.52	2.54
400	7.97	7.89	7.92	7.93	0.08	0.38	11.41	11.47	6.08	3.41	2.17	2.15	2.15	2.19
500	7.89	7.79	7.82	7.85	0.10	0.37	12.42	12.51	6.14	3.25	1.91	1.87	1.88	1.92
600	7.78	7.67	7.70	7.75	0.11	0.28	13.37	13.52	6.36	3.07	1.71	1.66	1.67	1.72
700	7.65	7.53	7.56	7.63	0.12	0.34	14.24	14.46	6.71	2.86	1.56	1.50	1.51	1.56
800	7.50	7.38	7.41	7.49	0.12	0.38	15.05	15.31	7.14	2.64	1.43	1.37	1.38	1.43
900	7.34	7.23	7.25	7.34	0.12	0.55	15.81	16.11	7.66	2.41	1.34	1.27	1.28	1.33
1000	7.18	7.07	7.09	7.18	0.11	0.72	16.55	16.83	8.24	2.18	1.26	1.19	1.20	1.24
1100	7.03	6.92	6.93	7.02	0.10	0.76	17.26	17.51	8.91	1.95	1.20	1.13	1.14	1.18
1200	6.88	6.79	6.80	6.88	0.09	0.92	17.99	18.16	9.65	1.73	1.14	1.09	1.09	1.12
1300	6.77	6.68	6.70	6.75	0.09	1.04	18.76	18.80	10.45	1.54	1.10	1.07	1.05	1.08
1400	6.70	6.60	6.63	6.67	0.09	1.15	19.62	19.46	11.30	1.37	1.07	1.06	1.03	1.05
1500	6.66	6.56	6.60	6.61	0.09	1.15	20.59	20.21	12.17	1.23	1.05	1.07	1.03	1.03
1550	6.65	6.56	6.61	6.60	0.08	1.17	21.15	20.64	12.61	1.18	1.04	1.07	1.04	1.02
1600	6.66	6.56	6.62	6.61	0.09	1.14	21.75	21.10	13.03	1.15	1.03	1.08	1.05	1.01
1650	6.66	6.57	6.64	6.62	0.09	1.16	22.41	21.61	13.44	1.15	1.02	1.09	1.06	1.01
1700	6.68	6.59	6.65	6.64	0.09	1.15	23.14	22.19	13.84	1.17	1.02	1.10	1.07	1.02
1750	6.70	6.62	6.68	6.66	0.09	1.27	23.95	22.83	14.23	1.20	1.02	1.11	1.09	1.04
1800	6.73	6.66	6.71	6.70	0.07	1.36	24.88	23.58	14.62	1.24	1.03	1.12	1.10	1.05
1850	6.75	6.69	6.74	6.73	0.07	1.41	25.89	24.43	15.01	1.28	1.04	1.13	1.12	1.07
1900	6.77	6.72	6.78	6.76	0.06	1.40	27.09	25.42	15.41	1.31	1.05	1.14	1.13	1.08
1950	6.80	6.75	6.81	6.80	0.06	1.54	28.47	26.60	15.86	1.34	1.07	1.15	1.14	1.10
2000	6.82	6.79	6.84	6.83	0.05	1.56	30.08	28.00	16.35	1.36	1.07	1.16	1.15	1.11
2050	6.83	6.82	6.86	6.86	0.04	1.62	32.10	29.71	16.91	1.38	1.08	1.16	1.16	1.12
2100	6.84	6.84	6.89	6.88	0.05	1.65	34.63	31.93	17.55	1.38	1.09	1.16	1.16	1.12
2150	6.85	6.87	6.90	6.90	0.05	1.74	38.09	34.91	18.31	1.37	1.09	1.16	1.16	1.13
2200	6.85	6.89	6.91	6.91	0.06	1.79	43.04	39.41	19.21	1.36	1.08	1.16	1.16	1.13
2250	6.84	6.90	6.91	6.91	0.07	1.82	46.66	48.12	20.31	1.33	1.08	1.15	1.15	1.13
2300	6.84	6.90	6.92	6.92	0.08	1.85	41.71	45.40	21.67	1.29	1.07	1.14	1.14	1.12
2350	6.83	6.90	6.92	6.93	0.10	1.85	37.36	38.27	23.40	1.24	1.05	1.13	1.13	1.11
2400	6.83	6.91	6.93	6.93	0.10	1.85	34.42	34.34	25.62	1.19	1.04	1.12	1.13	1.10
2450	6.82	6.92	6.94	6.94	0.11	1.94	32.33	31.76	28.52	1.14	1.02	1.12	1.12	1.09
2500	6.83	6.93	6.95	6.96	0.13	1.97	30.70	29.88	31.46	1.09	1.01	1.12	1.13	1.08
2550	6.85	6.96	6.98	6.98	0.13	2.05	29.45	28.48	31.29	1.08	1.03	1.13	1.14	1.08
2600	6.87	7.00	7.02	7.03	0.16	2.10	28.47	27.40	28.05	1.14	1.06	1.16	1.17	1.10
2650	6.92	7.06	7.08	7.10	0.17	2.11	27.71	26.59	24.95	1.23	1.10	1.19	1.21	1.13
2700	6.99	7.14	7.16	7.18	0.20	2.31	27.11	26.03	22.50	1.34	1.13	1.24	1.25	1.17
2750	7.08	7.26	7.25	7.29	0.21	2.44	26.65	25.62	20.58	1.47	1.17	1.29	1.30	1.22
2800	7.20	7.39	7.38	7.43	0.23	2.59	26.31	25.39	19.10	1.62	1.21	1.35	1.36	1.27
2850	7.34	7.55	7.53	7.60	0.25	2.69	26.13	25.30	17.90	1.79	1.26	1.42	1.41	1.33
2900	7.51	7.75	7.71	7.79	0.28	2.80	26.00	25.34	16.95	1.99	1.30	1.48	1.47	1.39
2950	7.70	7.97	7.91	8.01	0.30	2.85	25.97	25.48	16.18	2.20	1.35	1.56	1.54	1.46
3000	7.92	8.20	8.13	8.23	0.31	3.00	26.00	25.70	15.59	2.43	1.41	1.63	1.61	1.53
3100	8.37	8.70	8.61	8.73	0.36	3.08	26.23	26.42	14.81	2.93	1.51	1.77	1.74	1.67
3200	8.85	9.20	9.09	9.21	0.36	3.20	26.61	27.43	14.49	3.46	1.64	1.91	1.88	1.81
3300	9.28	9.63	9.53	9.64	0.36	3.14	27.03	28.53	14.53	3.93	1.78	2.04	2.02	1.96
3400	9.61	9.93	9.85	9.96	0.35	3.20	27.50	29.60	14.87	4.29	1.93	2.16	2.17	2.10
3500	9.81	10.08	10.05	10.15	0.34	3.31	27.98	30.63	15.61	4.44	2.08	2.27	2.31	2.24
3600	9.84	10.08	10.09	10.16	0.31	3.68	28.50	31.68	16.83	4.36	2.23	2.36	2.43	2.36
3700	9.71	9.87	9.94	10.02	0.31	3.77	29.23	32.27	18.61	4.02	2.35	2.44	2.53	2.46
3800	9.44	9.53	9.62	9.71	0.27	3.96	30.15	32.79	21.67	3.51	2.46	2.49	2.61	2.54
3900	9.05	9.07	9.19	9.28	0.23	4.09	32.01	33.88	28.12	2.86	2.52	2.52	2.63	2.59
4000	8.63	8.60	8.71	8.81	0.21	4.44	35.83	36.48	36.10	2.22	2.54	2.51	2.61	2.58
4100	8.30	8.22	8.30	8.43	0.22	4.70	41.52	43.98	22.09	1.67	2.51	2.48	2.55	2.55

<sup>1</sup> Total Loss = Insertion Loss+ 6dB Splitter Loss

REV. X2  
SBD-4-25  
100627

Page 3 of 3



IF/RF MICROWAVE COMPONENTS • ISO 9001 ISO 14001 AS 9100 CERTIFIED • RoHS compliant  
P.O. Box 350166, Brooklyn, New York 11235-0006 (718) 934-4500 Fax (718) 332-4661



The Design Engineers Search Engine finds the model you need, instantly • For detailed performance specs & shopping online see



# 4 Way-0° Power Splitter/Combiner

# SBD-4-25

## Typical Performance Curves

### Total Loss

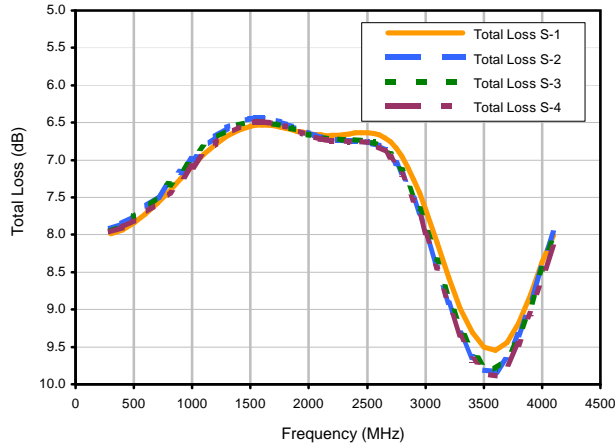

### Total Loss S-1 vs. TEMPERATURE

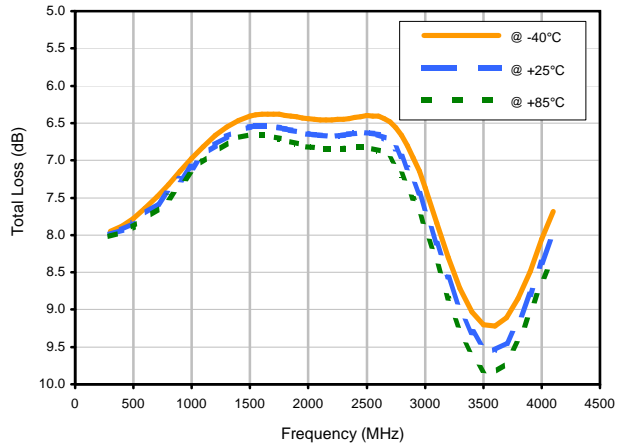

### Amplitude Unbalance vs. TEMPERATURE

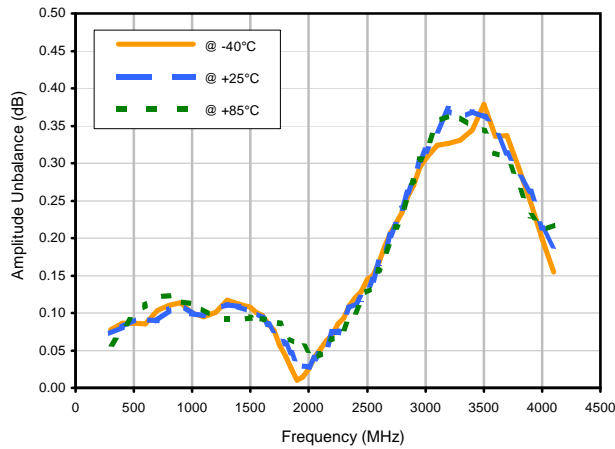

### Phase Unbalance vs. TEMPERATURE

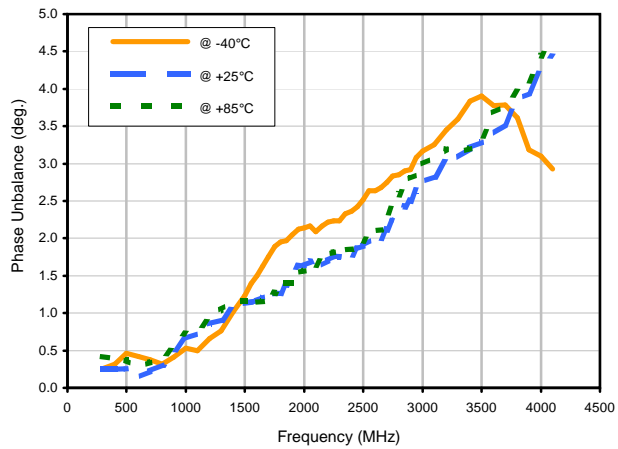

### Isolation

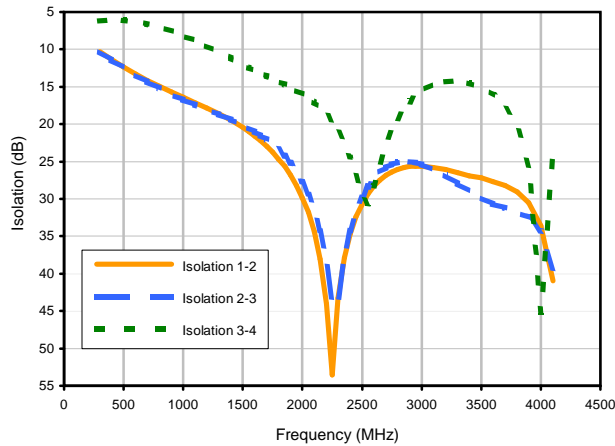

### Isolation 1-2 vs. TEMPERATURE

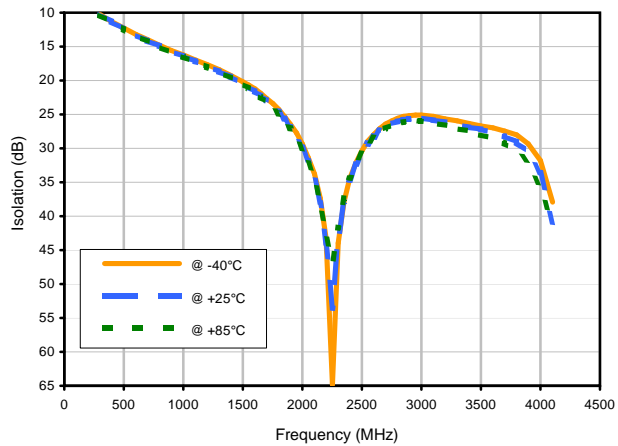

REV. X2  
SBD-4-25  
100627  
Page 1 of 2



RF/MICROWAVE COMPONENTS • ISO 9001 ISO 14001 AS 9100 CERTIFIED • RoHS compliant  
P.O. Box 350166, Brooklyn, New York 11235-0003 (718) 934-4500 Fax (718) 332-4661



The Design Engineers Search Engine finds the model you need, Instantly • For detailed performance specs & shopping online see



## Typical Performance Curves

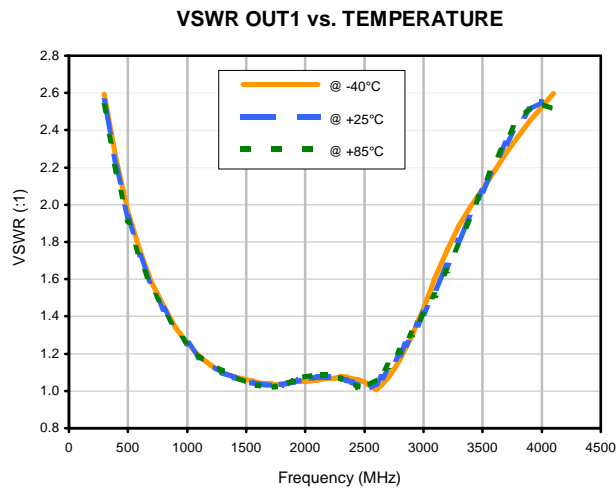
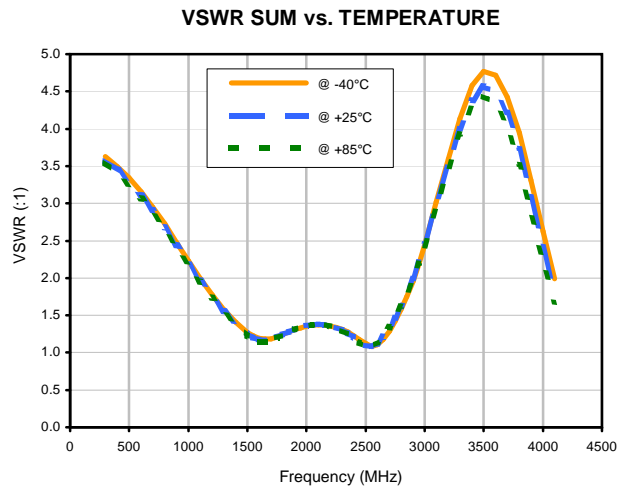
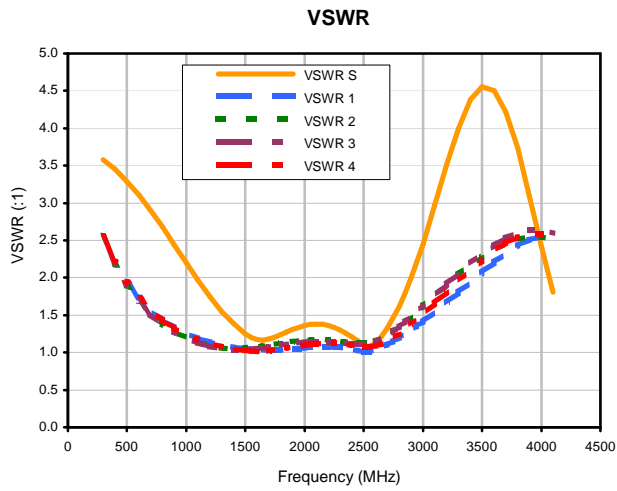

# Case Style

# SM34

SM34

## Outline Dimensions

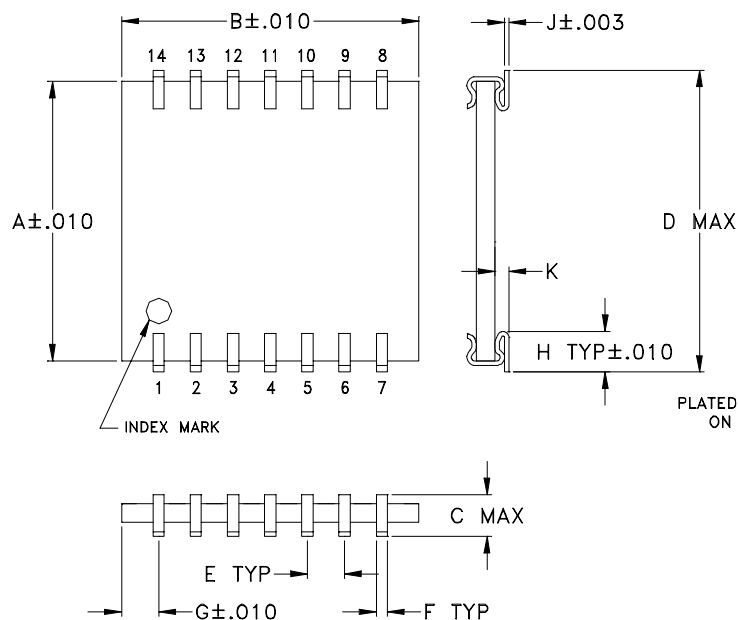

## PCB Land Pattern

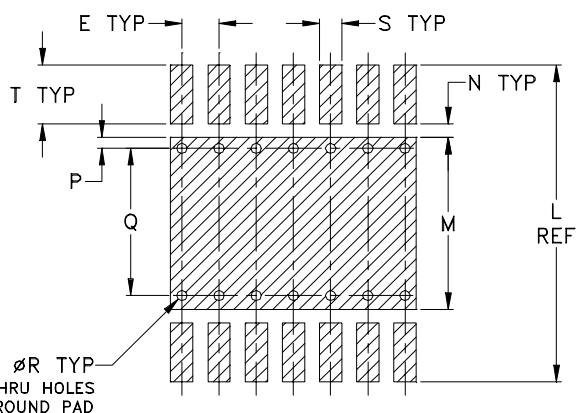

Suggested Layout,  
Tolerance to be within  $\pm 0.002$

ADJACENT GROUND PINS SHALL BE CONNECTED  
TO EACH OTHER AND TO GROUND PAD

CASE #	A	B	C	D	E	F	G	H	J	K	L	M	N
SM34	.380 (9.65)	.400 (10.16)	.070 (1.78)	.420 (10.67)	.050 (1.27)	.015 (0.38)	.050 (1.27)	.060 (1.52)	.006 (0.15)	.020 (0.51)	.430 (10.92)	.234 (5.94)	.018 (0.46)

CASE #	P	Q	R	S	T	WT. GRAM
SM34	.015 (0.38)	.200 (5.08)	.014 (0.36)	.030 (0.76)	.080 (2.03)	.3

Dimensions are in inches (mm). Tolerances:  $\pm .005$

### Notes:

- Case material: Ceramic.
- Termination finish:  
For RoHS Case Styles: Tin plate over Nickel plate.  
For RoHS-5 Case Styles: Tin-Lead plate.



Distribution Centers NORTH AMERICA 800-654-7949 • 417-335-5935 • Fax 417-335-5945 • EUROPE 44-1252-832600 • Fax 44-1252-837010

Mini-Circuits ISO 9001 & ISO 14001 Certified

INTERNET <http://www.minicircuits.com>

P.O. Box 350166, Brooklyn, New York 11235-0003 (718) 934-4500 Fax (718) 332-4661

# Tape & Reel Packaging TR-F10

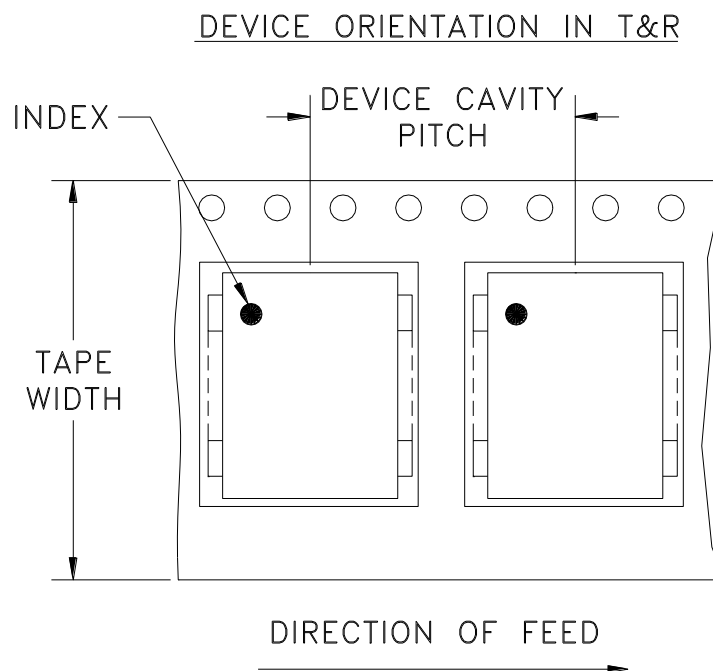

Tape Width, mm	Device Cavity Pitch, mm	Reel Size, inches	Devices per Reel
24	16	7	10,20,50,100
		13	200,500

Mini-Circuits carrier tape materials provide protection from ESD (Electro-Static Discharge) during handling and transportation. Tapes are static dissipative and comply with industry standards EIA-481/EIA-541.

Go to: [www.minicircuits.com/pages/pdfs/tape.pdf](http://www.minicircuits.com/pages/pdfs/tape.pdf)

Note: Please consult individual model data sheet to determine device per reel availability.



INTERNET <http://www.minicircuits.com>

P.O. Box 350166, Brooklyn, New York 11235-0003 (718) 934-4500 Fax (718) 332-4661

Distribution Centers NORTH AMERICA 800-654-7949 • 417-335-5935 • Fax 417-335-5945 • EUROPE 44-1252-832600 • Fax 44-1252-837010

Mini-Circuits ISO 9001 & ISO 14001 Certified

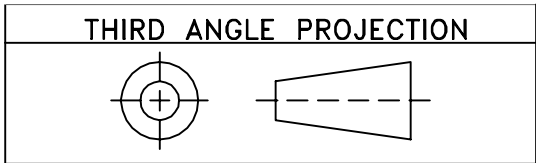

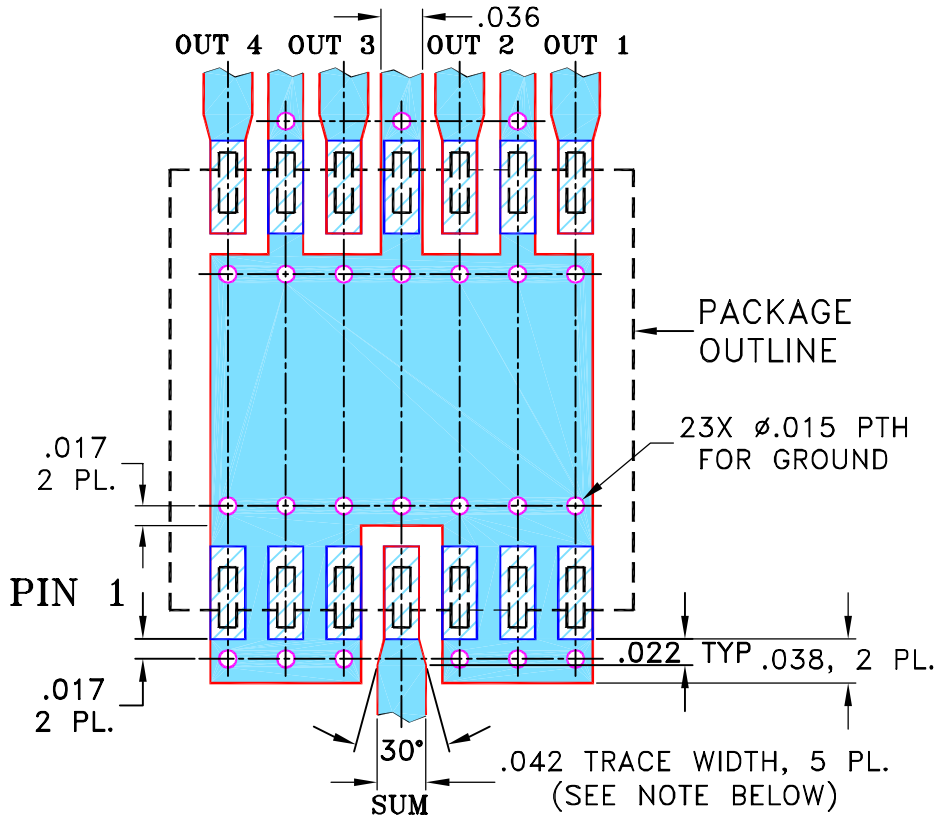

REVISIONS					
REV	ECN No.	DESCRIPTION	DATE	DR	AUTH
OR	M88804	NEW RELEASE	12/13/05	MMG	HY
A	M102713	.042 WAS .044 & ADDED "...WITH SMOBC"	01/25/06	MMG	HY

**SUGGESTED MOUNTING CONFIGURATION  
FOR SM34 CASE STYLE, "lj" PIN CONNECTION.**



- NOTES: 1. TRACE WIDTH IS SHOWN FOR ROGERS R04350B WITH DIELECTRIC THICKNESS  $.020 \pm .0015$ ; COPPER: 1/2 OZ. EACH SIDE. FOR OTHER MATERIALS TRACE WIDTH MAY NEED TO BE MODIFIED.
2. BOTTOM SIDE OF THE PCB IS CONTINUOUS GROUND PLANE.

-  DENOTES PCB COPPER LAYOUT WITH SMOBC (SOLDER MASK OVER BARE COPPER)
-  DENOTES COPPER LAND PATTERN FREE OF SOLDERMASK

UNLESS OTHERWISE SPECIFIED	INITIALS	DATE
DIMENSIONS ARE IN INCHES TOLERANCES ON: 2 PL DECIMALS $\pm$ 3 PL DECIMALS $\pm$ .005 ANGLES $\pm$ FRACTIONS $\pm$	DRAWN	MMG 12/05/05
	CHECKED	AV 12/13/05
	APPROVED	HY 12/13/05

 **Mini-Circuits®** 13 Neptune Avenue  
Brooklyn NY 11235

PL, lj, SM34, SBD-4-25, TB-85

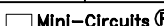
 Mini-Circuits®

THIS DOCUMENT AND ITS CONTENTS ARE THE PROPERTY OF MINI-CIRCUITS. EXCEPT FOR USE EXPRESSLY GRANTED, IN WRITING, TO ITS VENDORS, VENDEE AND THE UNITED STATES GOVERNMENT, MINI-CIRCUITS RESERVES ALL PROPRIETARY DESIGN, USE, MANUFACTURING AND REPRODUCTION RIGHTS THERETO. THESE CONTENTS SHALL NOT BE USED, DUPLICATED OR DISCLOSED TO ANY OUTSIDE PARTY, IN WHOLE OR IN PART, WITHOUT WRITTEN PERMISSION OF MINI-CIRCUITS.

ASHEETA1.DWG REV:A DATE:01/12/95

SIZE	CODE IDENT	DRAWING NO:	REV:
A	15542	98-PL-142	A
FILE:	98PL142	SCALE: 6:1	SHEET: 1 OF 1

# Evaluation Board and Circuit

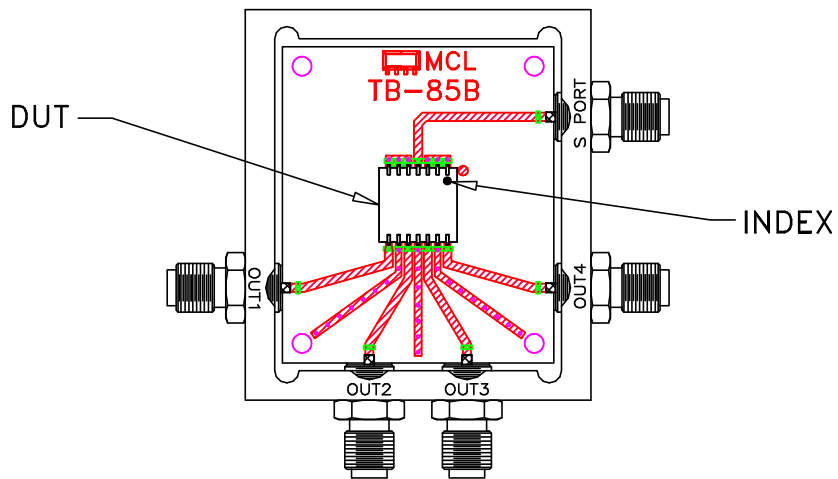

TB-85

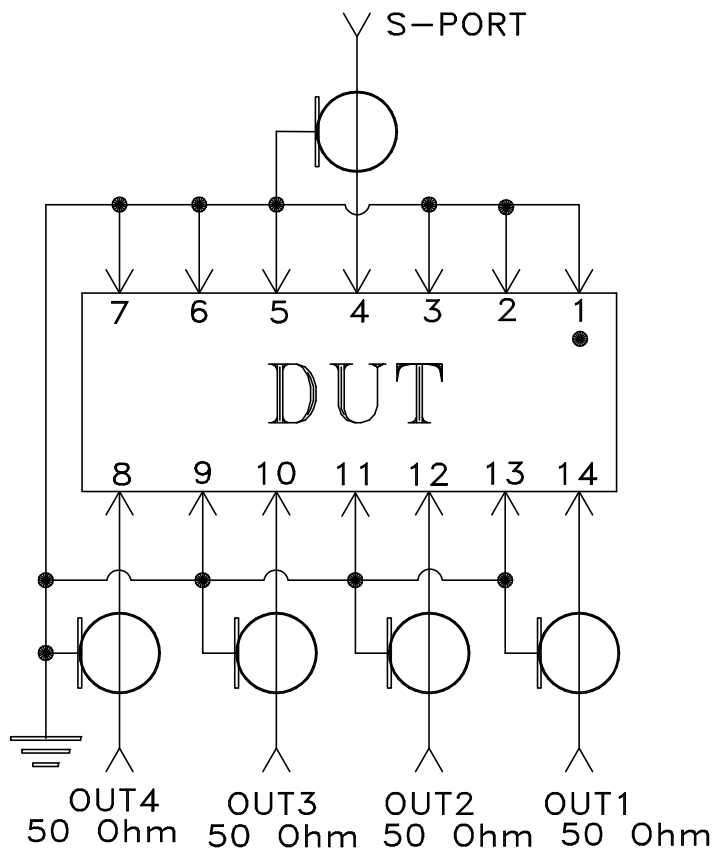

Schematic Diagram

## Notes:

1. SMA Female connectors.
2. PCB Material: Rogers RO4350 or equivalent,  
Dielectric Constant=3.5, Thickness=.020 inch.

 **Mini-Circuits®**

All Mini-Circuits products are manufactured under exacting quality assurance and control standards, and are capable of meeting published specifications after being subjected to any or all of the following physical and environmental test.

Specification	Test/Inspection Condition	Reference/Spec
Operating Temperature	-40° to 85°C Ambient Environment	Individual Model Data Sheet
Storage Temperature	-55° to 100° C Ambient Environment	Individual Model Data Sheet
Humidity	90 to 95% RH, 240 hours, 50°C	MIL-STD-202, Method 103, Condition A, Except 50°C and end-point electrical test done within 12 hours
Thermal Shock	-55° to 100°C, 100 cycles	MIL-STD-202, Method 107, Condition A-3, except +100°C
Solder Reflow Heat	Sn-Pb Eutetic Process: 225°C peak Pb-Free Process 245° - 250°C peak	J-STD-020, Table 4-1, 4-2 and 5-2, Figure 5-1
Solderability	10X Magnification	J-STD-002, 95% Coverage
Vibration (High Frequency)	20g peak, 10-2000 Hz, 12 times in each of three perpendicular directions (total 36)	MIL-STD-202, Method 204, Condition D
Mechanical Shock	50g, 11 ms, 1/2-sine, 18 shocks: 3 each direction, each of 3 axes	MIL-STD-202, Method 213, Condition A
Marking Resistance to Solvents	Isopropyl alcohol + mineral spirits at 25°C; terpene defluxer at 25°C; distilled water + proylene glycol monomethyl ether + monoethanolamine at 63°C to 70°C	MIL-STD-202, Method 215