



CERAMIC

Power Splitter/Combiner

SCW-2-482+

Mini-Circuits

2 Way-0° 50Ω 3300 to 4800 MHz

THE BIG DEAL

- Isolation Resistor, External 100Ω
- Small Size, 1.6x0.8 mm
- ESD Non-Sensitive
- Temperature Stable LTCC Technology
- Wrap-Around Terminations for Excellent Solderability
- Low Cost



Generic photo used for illustration purposes only

CASE STYLE: JC0603C

+RoHS Compliant

The +Suffix identifies RoHS Compliance. See our website for RoHS Compliance methodologies and qualifications

APPLICATIONS

- LTE
- 5G Sub 6 GHz

PRODUCT OVERVIEW

Mini-Circuits' new LTCC 0° Power Splitter SCW-2-482+, offers industry leading combination of operating performance and size. The outstanding phase and amplitude unbalance make this component a versatile building block for use in a variety of systems and sub-system designs.

KEY FEATURES

Feature	Advantages
Small Size	Offered in the package size, SCW-2-482+ offers an industry leading combination of size, power handling, and frequency. The small footprint allows for reduced parasitics in systems with improved performance and simplified layout.
Wrap-Around Terminations	Provides excellent solderability and easy visual inspection.
LTCC Construction	Provides repeatable performance in the rugged, ceramic package well suited for tough environments such as high humidity and temperature extremes.





CERAMIC

Power Splitter/Combiner

SCW-2-482+

Mini-Circuits

2 Way-0° 50Ω 3300 to 4800 MHz

ELECTRICAL SPECIFICATIONS AT +25°C

Parameter	Frequency (MHz)	Min.	Typ.	Max.	Unit
Frequency Range		3300		4800	MHz
Insertion Loss, Above 3.0 dB	3300-4800		0.7	1	dB
Isolation	3300-4800	12	15		dB
Phase Unbalance	3300-4800		2	6	Degree
Amplitude Unbalance	3300-4800		0.2	0.5	dB
Return Loss (Input)	3300-4800		13		dB
Return Loss (Output)	3300-4800		16		dB

ABSOLUTE MAXIMUM RATINGS

Parameter	Ratings
Operating Temperature	-55°C to +125°C
Storage Temperature	-55°C to +125°C
Power Input (as a Splitter)	2 W ¹ max.

1. Power input as combiner is limited by rating of external resistor 100Ω resistor. Permanent damage may occur if any of these limits are exceeded.

ELECTRICAL SCHEMATIC

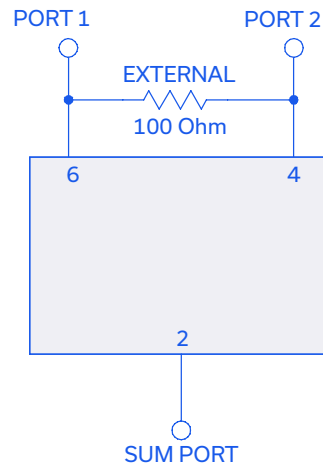



CERAMIC

Power Splitter/Combiner

SCW-2-482+

Mini-Circuits

2 Way-0° 50Ω 3300 to 4800 MHz

PAD CONNECTIONS

SUM PORT	2
PORT 1	6
PORT 2	4
GROUND	1,3,5
PORT 1-2	Resistor external 100Ω

PRODUCT MARKING: 1

DEMO BOARD MCL P/N: TB-SCW-2-482+
SUGGESTED PCB LAYOUT (PL-727)

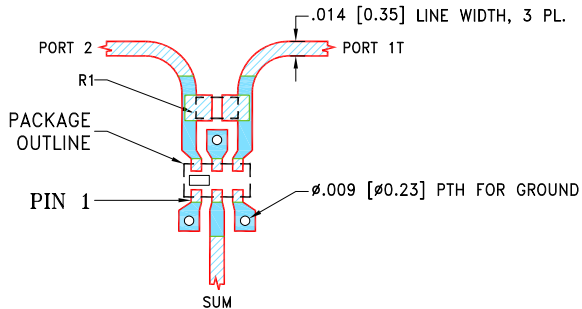

COMPONENT	SIZE
R1	0402

NOTES:

- LINE WIDTH IS SHOWN FOR ROGERS RO4350B WITH DIELECTRIC THICKNESS .0066±.0007"; COPPER: 1/2 OZ. EACH SIDE. FOR OTHER MATERIALS LINE WIDTH MAY NEED TO BE MODIFIED.
- CHIP COMPONENT FOOT PRINTS SHOWN FOR REFERENCE. FOR COMPONENT VALUES REFER TO TB-1224+.
- BOTTOM SIDE OF THE PCB IS CONTINUOUS GROUND PLANE.

- DENOTES PCB COPPER LAYOUT WITH SMOBC (SOLDER MASK OVER BARE COPPER).
- DENOTES COPPER LAND PATTERN FREE OF SOLDER MASK.

OUTLINE DRAWING

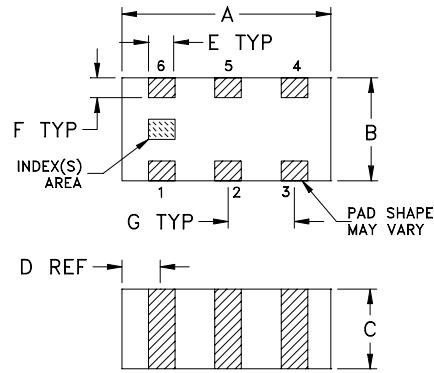

PCB Land Pattern

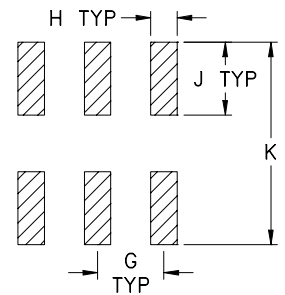

Suggested Layout,
Tolerance to be within ±.002

OUTLINE DIMENSIONS (Inches/mm)

A	B	C	D	E	F
.063	.031	.024	.012	.008	.006
1.60	0.79	0.61	0.30	0.20	0.15
G	H	J	K	wt	
.020	.010	.022	.053	grams	
0.51	0.25	0.56	1.35	0.005	

TAPE & REEL INFORMATION: F114



CERAMIC

Power Splitter/Combiner

SCW-2-482+

Mini-Circuits

2 Way-0° 50Ω 3300 to 4800 MHz

TYPICAL PERFORMANCE DATA

Frequency (MHz)	Total Loss ² (dB)		Amplitude Unbalance (dB)	Isolation (dB)	Phase Unbalance (deg.)	Return Loss (dB)		
	S-1	S-2				S	1	2
3300	3.39	3.36	0.03	14.06	2.73	14.49	33.56	33.80
3400	3.37	3.34	0.03	14.71	2.83	14.99	34.75	34.83
3500	3.36	3.33	0.03	15.40	2.92	15.49	36.07	37.99
3600	3.35	3.32	0.03	16.14	3.03	16.01	37.85	39.77
3700	3.34	3.30	0.04	16.92	3.12	16.51	38.73	45.93
3800	3.33	3.29	0.04	17.77	3.21	17.09	37.47	45.07
3900	3.33	3.28	0.04	18.69	3.29	17.59	35.63	42.75
4000	3.32	3.28	0.04	19.67	3.37	18.14	33.38	39.02
4100	3.32	3.27	0.05	20.68	3.45	18.57	31.39	35.69
4200	3.32	3.27	0.05	21.72	3.53	18.94	29.40	33.39
4300	3.32	3.27	0.05	22.72	3.61	19.13	27.66	31.06
4400	3.33	3.27	0.06	23.65	3.69	19.21	26.03	29.27
4500	3.34	3.28	0.06	24.27	3.76	19.09	24.54	27.50
4600	3.35	3.28	0.06	24.46	3.83	18.78	23.20	25.80
4800	3.39	3.31	0.07	23.39	3.98	17.54	20.82	22.84

2. Total Loss = Insertion Loss + 3 dB splitter loss.

TOTAL LOSS

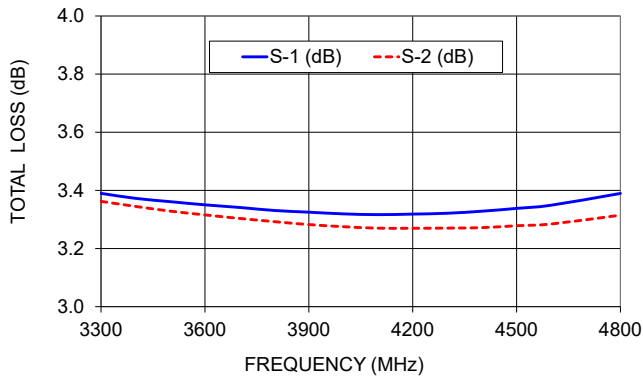

ISOLATION

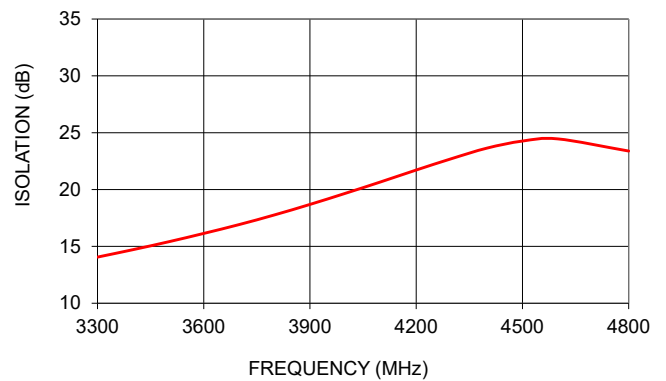

RETURN LOSS

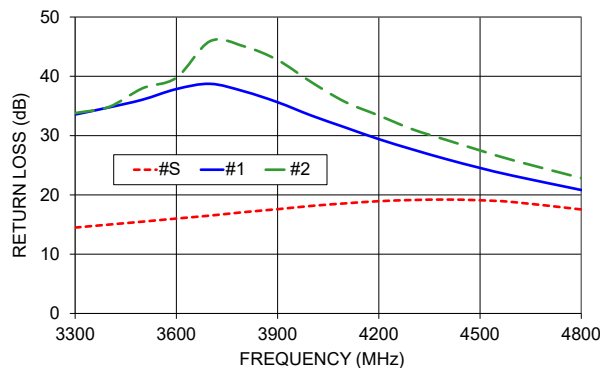

NOTES

- A. Performance and quality attributes and conditions not expressly stated in this specification document are intended to be excluded and do not form a part of this specification document.
- B. Electrical specifications and performance data contained in this specification document are based on Mini-Circuit's applicable established test performance criteria and measurement instructions.
- C. The parts covered by this specification document are subject to Mini-Circuits standard limited warranty and terms and conditions (collectively, "Standard Terms"); Purchasers of this part are entitled to the rights and benefits contained therein. For a full statement of the standard terms and the exclusive rights and remedies thereunder, please visit Mini-Circuits' website at www.minicircuits.com/terms/viewterm.html



2 Way-0° Power Splitter/Combiner

SCW-2-482+

Typical Performance Data

FREQUENCY (MHz)	TOTAL LOSS ¹ (dB)		AMPLITUDE UNBALANCE (dB)	ISOLATION (dB) 1-2	PHASE UNBALANCE (deg.)	FREQUENCY (MHz)	VSWR (:1)		
	S-1	S-2					S	1	2
3300	3.39	3.36	0.03	14.06	2.73	3300	1.46	1.04	1.04
3330	3.38	3.36	0.03	14.25	2.76	3330	1.46	1.04	1.04
3360	3.38	3.35	0.03	14.44	2.79	3360	1.45	1.04	1.04
3390	3.38	3.35	0.03	14.64	2.82	3390	1.44	1.04	1.04
3420	3.37	3.34	0.03	14.85	2.84	3420	1.43	1.04	1.04
3450	3.37	3.34	0.03	15.04	2.87	3450	1.42	1.03	1.03
3480	3.36	3.33	0.03	15.26	2.90	3480	1.41	1.03	1.03
3510	3.36	3.33	0.03	15.47	2.93	3510	1.40	1.03	1.02
3540	3.36	3.32	0.04	15.69	2.98	3540	1.39	1.03	1.02
3570	3.35	3.32	0.03	15.91	3.00	3570	1.38	1.03	1.02
3600	3.35	3.32	0.03	16.14	3.03	3600	1.38	1.03	1.02
3630	3.35	3.31	0.04	16.37	3.05	3630	1.37	1.03	1.02
3660	3.34	3.31	0.04	16.61	3.08	3660	1.36	1.02	1.01
3690	3.34	3.31	0.04	16.84	3.10	3690	1.35	1.02	1.01
3720	3.34	3.30	0.04	17.09	3.14	3720	1.35	1.02	1.01
3750	3.34	3.30	0.04	17.35	3.17	3750	1.34	1.02	1.01
3780	3.33	3.30	0.04	17.60	3.19	3780	1.33	1.03	1.01
3810	3.33	3.29	0.04	17.86	3.21	3810	1.32	1.03	1.01
3840	3.33	3.29	0.04	18.13	3.24	3840	1.32	1.03	1.01
3870	3.33	3.29	0.04	18.41	3.26	3870	1.31	1.03	1.01
3900	3.33	3.28	0.04	18.69	3.29	3900	1.30	1.03	1.01
3930	3.32	3.28	0.04	18.97	3.31	3930	1.30	1.04	1.02
3960	3.32	3.28	0.04	19.26	3.34	3960	1.29	1.04	1.02
3990	3.32	3.28	0.04	19.57	3.37	3990	1.28	1.04	1.02
4020	3.32	3.27	0.04	19.87	3.39	4020	1.28	1.05	1.02
4050	3.32	3.27	0.04	20.16	3.41	4050	1.27	1.05	1.03
4080	3.32	3.27	0.05	20.46	3.44	4080	1.27	1.05	1.03
4110	3.32	3.27	0.05	20.79	3.46	4110	1.27	1.06	1.03
4140	3.32	3.27	0.05	21.08	3.49	4140	1.26	1.06	1.04
4170	3.32	3.27	0.05	21.41	3.51	4170	1.26	1.07	1.04
4200	3.32	3.27	0.05	21.72	3.53	4200	1.25	1.07	1.04
4230	3.32	3.27	0.05	22.03	3.56	4230	1.25	1.07	1.05
4260	3.32	3.27	0.05	22.35	3.57	4260	1.25	1.08	1.05
4290	3.32	3.27	0.05	22.63	3.60	4290	1.25	1.08	1.06
4320	3.32	3.27	0.05	22.93	3.63	4320	1.25	1.09	1.06
4350	3.32	3.27	0.05	23.22	3.65	4350	1.25	1.10	1.07
4380	3.33	3.27	0.06	23.47	3.67	4380	1.25	1.10	1.07
4410	3.33	3.27	0.06	23.71	3.70	4410	1.25	1.11	1.07
4440	3.33	3.27	0.06	23.93	3.72	4440	1.25	1.11	1.08
4470	3.33	3.28	0.06	24.12	3.74	4470	1.25	1.12	1.08
4500	3.34	3.28	0.06	24.27	3.76	4500	1.25	1.13	1.09
4530	3.34	3.28	0.06	24.35	3.78	4530	1.25	1.13	1.09
4560	3.34	3.28	0.06	24.44	3.81	4560	1.26	1.14	1.10
4590	3.35	3.28	0.06	24.45	3.83	4590	1.26	1.15	1.11
4620	3.35	3.29	0.07	24.44	3.85	4620	1.26	1.15	1.11
4650	3.36	3.29	0.07	24.35	3.88	4650	1.27	1.16	1.12
4680	3.36	3.29	0.07	24.24	3.90	4680	1.27	1.17	1.12
4710	3.37	3.30	0.07	24.08	3.92	4710	1.28	1.18	1.13
4740	3.38	3.30	0.07	23.89	3.94	4740	1.29	1.18	1.14
4770	3.38	3.31	0.07	23.66	3.97	4770	1.30	1.19	1.15
4800	3.39	3.31	0.07	23.39	3.98	4800	1.31	1.20	1.16



P.O. Box 350166, Brooklyn, New York 11235-0003 (718) 934-4500 • Fax (718) 332-4661 For detailed performance specs & shopping online see Mini-Circuits web site



The Design Engineers Search Engine Provides ACTUAL Data Instantly From MINI-CIRCUITS At: www.minicircuits.com

IF/RF MICROWAVE COMPONENTS

2 Way-0° Power Splitter/Combiner

SCW-2-482+

Typical Performance Curves

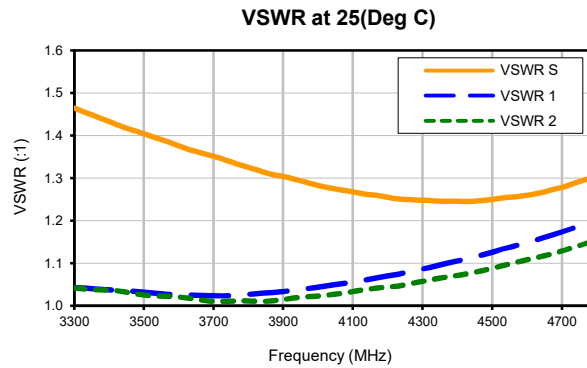
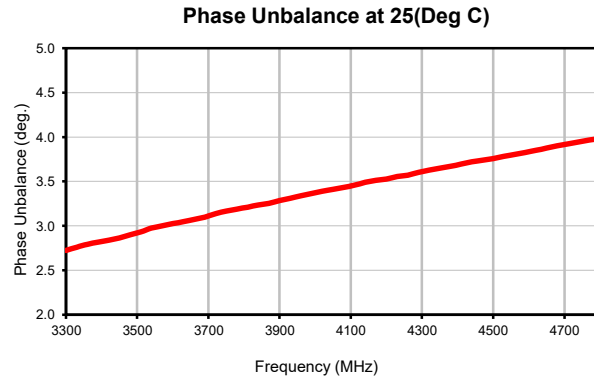
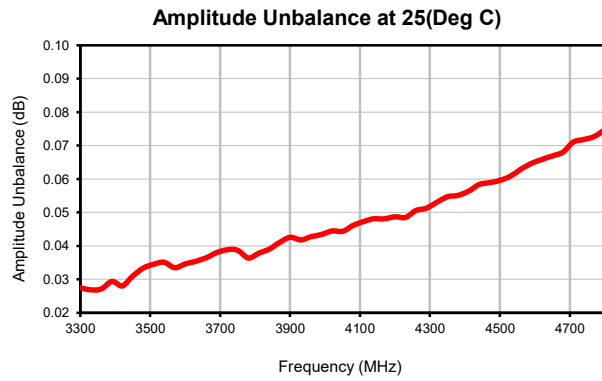
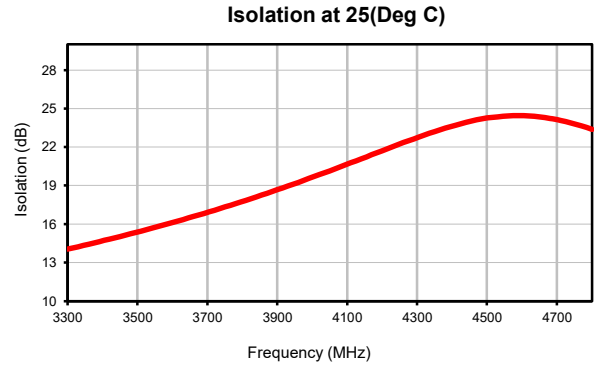
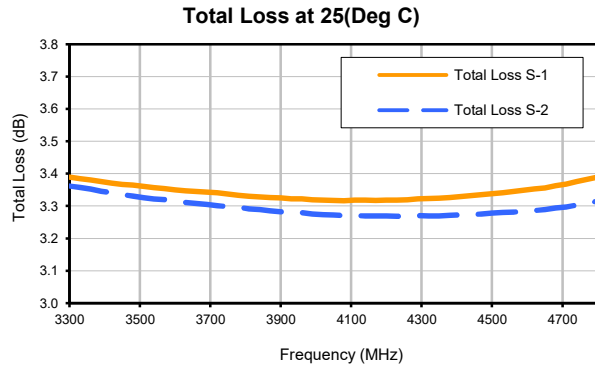

Case Style

JC

Outline Dimensions

JC0603C

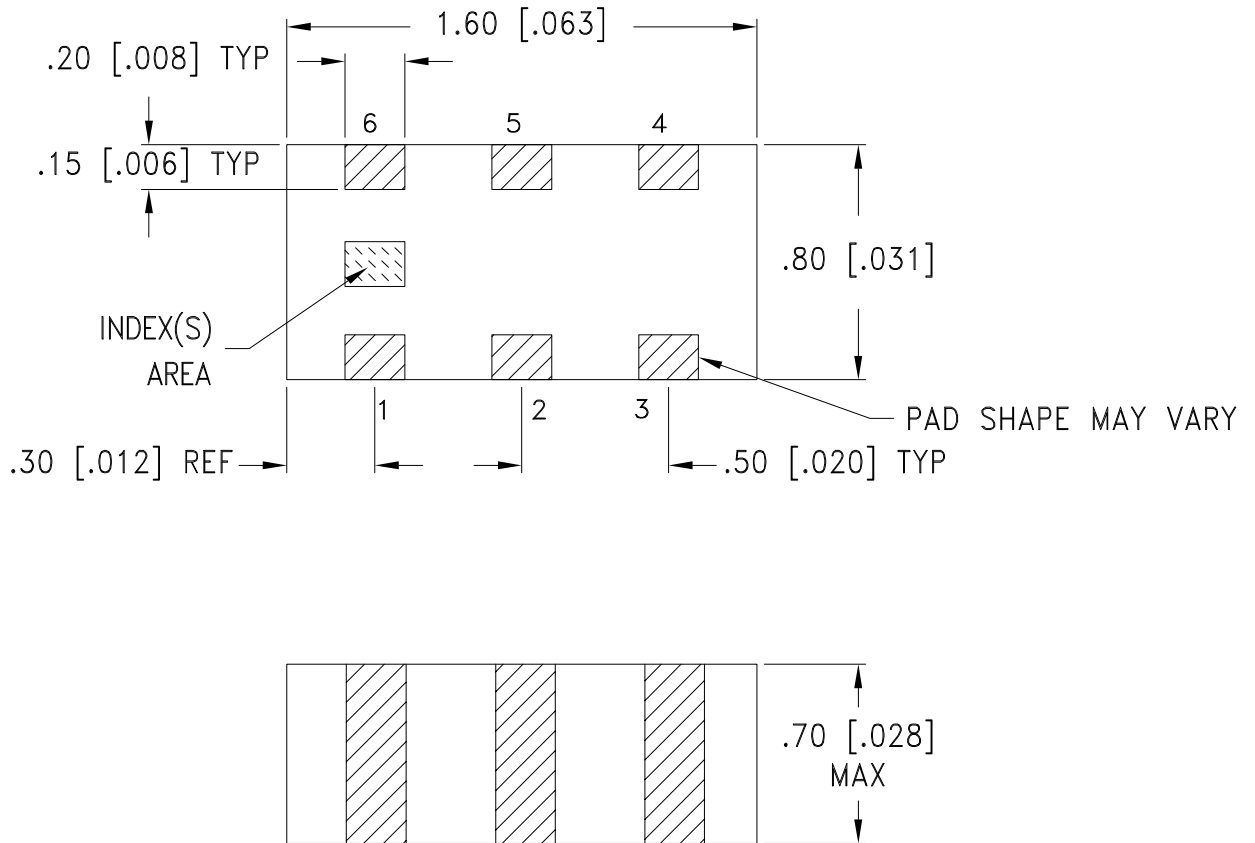

Weight: .005 grams

Dimensions are in mm [inch]. Tolerances: ± 0.13 mm

Notes:

1. Open style, ceramic base.
2. Termination finish:

For RoHS Case Styles: Tin plate over Nickel plate. All models, (+) suffix.



P.O. Box 350166, Brooklyn, New York 11235-0003 (718) 934-4500 Fax (718) 332-4661 For detailed performance specs & shopping online see Mini-Circuits web site



The Design Engineers Search Engine Provides ACTUAL Data Instantly From MINI-CIRCUITS At: www.minicircuits.com

RF/IF MICROWAVE COMPONENTS

Tape & Reel Packaging TR-F114

DEVICE ORIENTATION IN T&R



ILLUSTRATION 1

Applicable Case Styles	
GE0805C	JC0603C
GE0805C-1	JC0603C-4
GE0805C-1AP	JC0603C-6
GE0805C-7	
GE0805C-9	
GE0805C-10	
GE0805C-11	
GE0805C-12	



ILLUSTRATION 2

Applicable Case Styles	
GE0805C-2	JC0603C-1
GE0805C-3	JC0603C-2
GE0805C-4	JC0603C-3
GE0805C-5	JC0603C-5
GE0805C-6	JC0603C-7
GE0805C-8	
GE0805C-15	

Tape Width, mm	Device Cavity Pitch, mm	Reel Size, inches	Devices per Reel	
8	4	7	Small quantity standards (see note)	20
				50
				100
				200
				500
				1000
			Standard	4000

Note: Please Consult individual model data sheet to determine device per reel availability.

Mini-Circuits carrier tape materials provide protection from ESD (Electro-Static Discharge) during handling and transportation. Tapes are static dissipative and comply with industry standards EIA-481/EIA-541.

Go to: www.minicircuits.com/pages/pdfs/tape.pdf



INTERNET <http://www.minicircuits.com>

P.O. Box 350166, Brooklyn, New York 11235-0003 (718) 934-4500 Fax (718) 332-4661

Distribution Centers NORTH AMERICA 800-654-7949 • 417-335-5935 • Fax 417-335-5945 • EUROPE 44-1252-832600 • Fax 44-1252-837010

Mini-Circuits ISO 9001 & ISO 14001 Certified

THIRD ANGLE PROJECTION

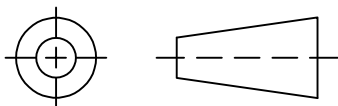

REVISIONS

REV	ECN No.	DESCRIPTION	DATE	DR	AUTH
OR	ECO-011925	NEW RELEASE	02/17/22	ITG	IL

SUGGESTED MOUNTING CONFIGURATION FOR
JC0603C CASE STYLE

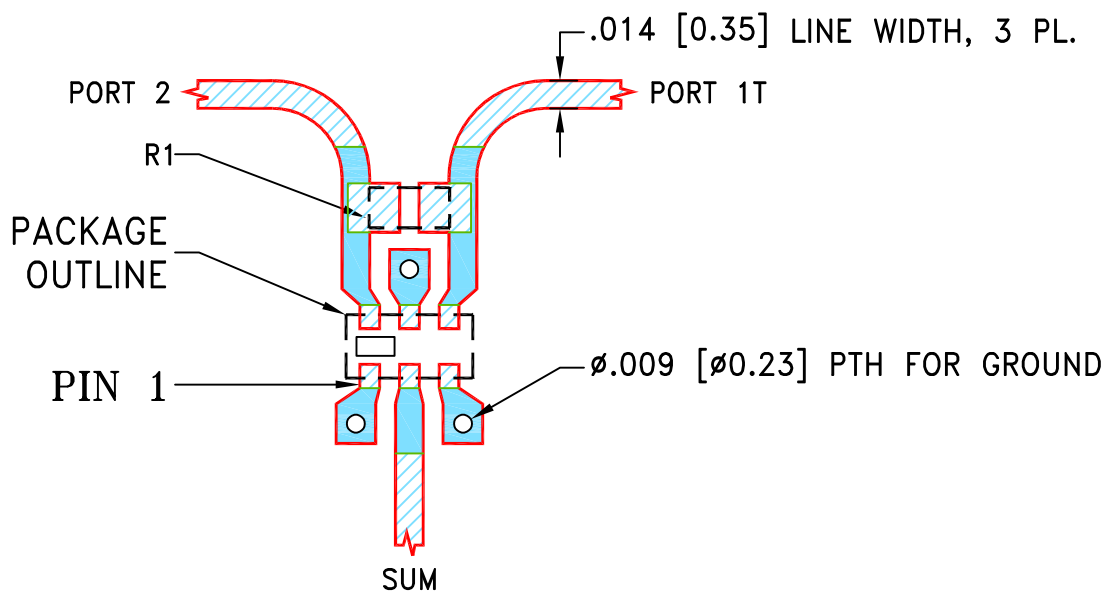

COMPONENT	SIZE
R1	0402

NOTES:

1. LINE WIDTH IS SHOWN FOR ROGERS R04350B WITH DIELECTRIC THICKNESS .0066±.0007"; COPPER: 1/2 OZ. EACH SIDE. FOR OTHER MATERIALS LINE WIDTH MAY NEED TO BE MODIFIED.
2. CHIP COMPONENT FOOT PRINTS SHOWN FOR REFERENCE. FOR COMPONENT VALUES REFER TO TB-1224+.
3. BOTTOM SIDE OF THE PCB IS CONTINUOUS GROUND PLANE.

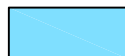

DENOTES PCB COPPER LAYOUT WITH SMOBC (SOLDER MASK OVER BARE COPPER).

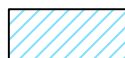

DENOTES COPPER LAND PATTERN FREE OF SOLDER MASK.

UNLESS OTHERWISE SPECIFIED	INITIALS	DATE
DIMENSIONS ARE IN INCHES	DRAWN ITG	02/17/22
TOLERANCES ON:	CHECKED GF	02/17/22
2 PL DECIMALS ±	APPROVED IL	02/17/22
3 PL DECIMALS ± .005		
ANGLES ±		
FRACTIONS ±		



Mini-Circuits®

13 Neptune Avenue
Brooklyn NY 11235

PL, SCW-2series, JC0603C, TB-1224+

Mini-Circuits®
THIS DOCUMENT AND ITS CONTENTS ARE THE PROPERTY OF MINI-CIRCUITS. EXCEPT FOR USE EXPRESSLY GRANTED, IN WRITING, TO ITS VENDORS, VENDEE AND THE UNITED STATES GOVERNMENT, MINI-CIRCUITS RESERVES ALL PROPRIETARY DESIGN, USE, MANUFACTURING AND REPRODUCTION RIGHTS THERETO. THESE CONTENTS SHALL NOT BE USED, DUPLICATED OR DISCLOSED TO ANY OUTSIDE PARTY, IN WHOLE OR IN PART, WITHOUT WRITTEN PERMISSION OF MINI-CIRCUITS.

SIZE	CODE IDENT	DRAWING NO:	REV:
A	15542	98-PL-727	OR
FILE:	98PL727	SCALE: 10:1	SHEET: 1 OF 1

Evaluation Board and Circuit

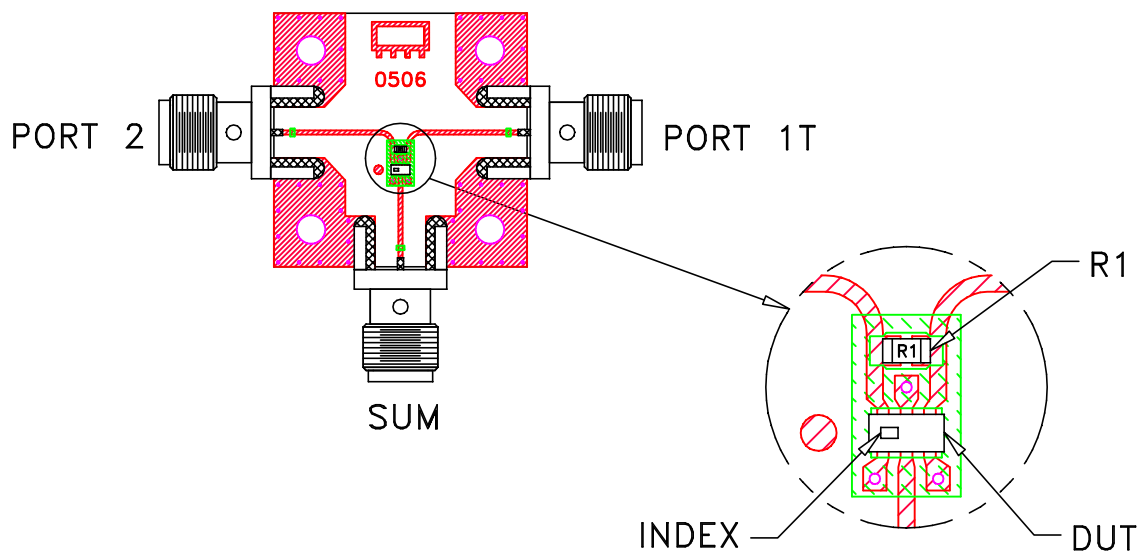

TB-1224+

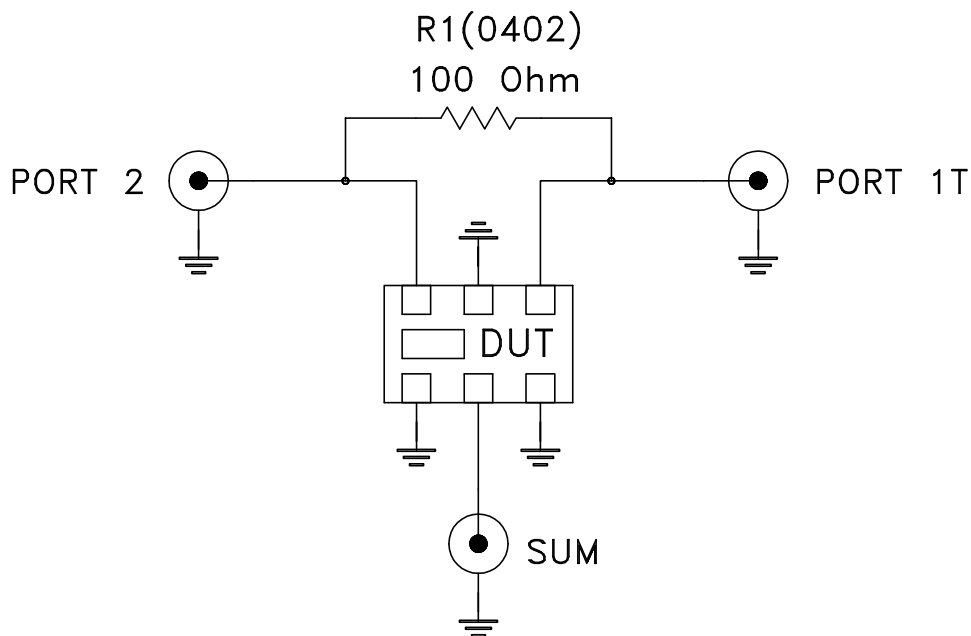

Schematic Diagram

Notes:

1. 50 Ohm SMA Female connectors.
2. PCB Material: R04350 or equivalent,
Dielectric Constant=3.5, Thickness=.0066 inch.

 **Mini-Circuits®**



All Mini-Circuits products are manufactured under exacting quality assurance and control standards, and are capable of meeting published specifications after being subjected to any or all of the following physical and environmental test.

Specification	Test/Inspection Condition	Reference/Spec
Operating Temperature	-55° to 125° C Ambient Environment	Individual Model Data Sheet
Storage Temperature	-55° to 125° C Ambient Environment	Individual Model Data Sheet
Humidity	90 to 95% RH, 240 hours, 50°C	MIL-STD-202, Method 103, Condition A, Except 50°C and end-point electrical test done within 12 hours
Solder Reflow Heat	Sn-Pb Eutectic Process: 225°C peak Pb-Free Process: 250°C peak	J-STD-020C, Table 4-1, 4-2 and 5-2; Figure 5-1
Solderability	10X Magnification	J-STD-002, Para 4.2.5, Test S, 95% Coverage
Vibration (High Frequency)	20g peak, 10-2000 Hz, 12 times in each of three perpendicular directions (total 36)	MIL-STD-202, Method 204, Condition D
Mechanical Shock	50g, 11 ms, 1/2-sine, 18 shocks: 3 each direction, each of 3 axes	MIL-STD-202, Method 213, Condition A