

Surface Mount

# Phase Shifter

**SPHSA-251+**

50Ω 180° Voltage Variable 150 to 250 MHz

## The Big Deal

- Low insertion loss, 1.5 dB typ.
- Wide phase shift, 180°
- Low frequency and small size



CASE STYLE: JW1441

## Product Overview

Mini-Circuits' SPHSA-251+ is a voltage variable phase shifter providing 180° phase control from 150 to 250 MHz in a miniature surface mount package. This model has a control bandwidth of DC to 30 kHz and a control voltage range from 0 to +15V. Housed in a shielded, 12-lead package with wrap-around terminations, the unit measures only 0.44 x 0.74 x 0.19", offering a space efficient, low-cost alternative to larger, expensive connectorized phase shifters typical for low frequency operation.

Feature	Advantages
Low insertion loss, 1.5 dB typ.	Enables good transmission of signal power from input to output and minimizes effect on system noise figure.
Wide phase shift, 180°	In test environments, 180° phase control allows the user to experiment with various incident phases. This can be used to test residual phase noise of amplifiers and to determine the influence of phase between two mismatched components in a system.

### Notes

- A. Performance and quality attributes and conditions not expressly stated in this specification document are intended to be excluded and do not form a part of this specification document.  
B. Electrical specifications and performance data contained in this specification document are based on Mini-Circuit's applicable established test performance criteria and measurement instructions.  
C. The parts covered by this specification document are subject to Mini-Circuits standard limited warranty and terms and conditions (collectively, "Standard Terms"); Purchasers of this part are entitled to the rights and benefits contained therein. For a full statement of the Standard Terms and the exclusive rights and remedies thereunder, please visit Mini-Circuits' website at [www.minicircuits.com/MCLStore/terms.jsp](http://www.minicircuits.com/MCLStore/terms.jsp)



# Phase Shifter

50Ω 180° Voltage Variable 150 to 250 MHz

## SPHSA-251+



Generic photo used for illustration purposes only  
CASE STYLE: JW1441

**+RoHS Compliant**

The +Suffix identifies RoHS Compliance. See our web site for RoHS Compliance methodologies and qualifications

### Maximum Ratings

Operating Temperature	-40°C to 85°C
Storage Temperature	-55°C to 100°C
RF Input Power	20 dBm max.
Control Voltage	20V

Permanent damage may occur if any of these limits are exceeded.

### Pin Connections

IN	2
OUT	5
BIAS	8,12 <sup>^</sup>
GROUND	1,3,4,6,7,9,10,11

<sup>^</sup> proper operation is achieved with pins 8 or 12 or both connected to BIAS.

### Features

- low insertion loss, 1.5 dB typ.
- wide phase shift, 180°
- aqueous washable

### Applications

- cellular
- communication

### Electrical Specifications at 25°C

Parameter	Condition (MHz)	Min.	Typ.	Max.	Unit
<b>Frequency Range</b>		150		250	MHz
<b>Phase Range</b>	150 - 250	180	—	—	Degrees
<b>Insertion Loss</b>	150 - 250	—	1.5	3.5	dB
<b>Control Voltage</b>	150 - 250	—	0-15	—	V
<b>Control Bandwidth</b>	150 - 250	—	DC-30	—	kHz
<b>VSWR</b>	150 - 250	—	1.6	2.5	:1

DC input resistance at Control port: 2000 ohms typ.

### Outline Drawing

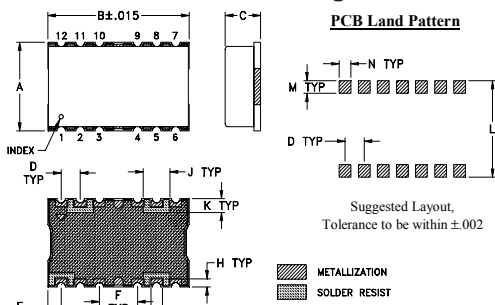

### Outline Dimensions (inch / mm)

A	B	C	D	E	F	G	H
.440	.740	.19	.100	.070	.200	.060	.040
11.18	18.80	4.83	2.54	1.78	5.08	1.52	1.02
J	K	L	M	N	P	wt	
.140	.070	.480	.063	.061	--	grams	
3.56	1.78	12.19	1.60	1.55	--	2.5	

### Demo Board MCL P/N: TB-524+ Suggested PCB Layout (PL-408)

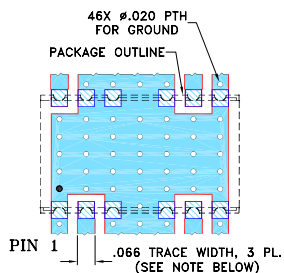

- NOTES: 1. TRACE WIDTH IS SHOWN FOR ROGERS RO4350 WITH DIELECTRIC THICKNESS .030" ± .002"; COPPER: 1/2 OZ. EACH SIDE. FOR OTHER MATERIALS TRACE WIDTH MAY NEED TO BE MODIFIED.  
2. BOTTOM SIDE OF THE PCB IS CONTINUOUS GROUND PLANE.  
■ DENOTES PCB COPPER LAYOUT WITH SMOBC (SOLDER MASK OVER BARE COPPER)  
■ DENOTES COPPER LAND PATTERN FREE OF SOLDER MASK

### Typical Performance Data

Control Voltage (V)	Phase Shift* (Degrees)			VSWR (:1)			Insertion Loss (dB)		
	150 MHz	200 MHz	250 MHz	150 MHz	200 MHz	250 MHz	150 MHz	200 MHz	250 MHz
0.0	0.01	0.01	0.01	1.10	1.14	1.73	1.33	1.22	1.58
1.0	24.23	12.97	5.88	1.07	1.19	1.70	1.51	1.36	1.61
2.0	46.91	25.98	11.76	1.07	1.25	1.66	1.64	1.52	1.64
3.0	69.53	40.70	18.54	1.17	1.31	1.61	1.75	1.65	1.69
4.0	91.78	58.22	27.01	1.30	1.36	1.53	1.83	1.85	1.76
5.0	112.67	79.19	38.16	1.45	1.38	1.43	1.87	1.99	1.86
6.0	131.26	103.36	53.33	1.58	1.36	1.29	1.86	2.04	2.01
7.0	146.85	128.64	73.76	1.67	1.30	1.29	1.81	1.99	2.24
8.0	159.33	151.94	99.51	1.72	1.25	1.13	1.73	1.88	2.51
9.0	169.05	171.21	128.38	1.74	1.25	1.30	1.65	1.75	2.69
10.0	176.58	186.24	156.49	1.75	1.27	1.41	1.58	1.64	2.65
11.0	182.48	197.74	180.79	1.75	1.31	1.42	1.52	1.56	2.44
12.0	187.09	206.48	200.05	1.75	1.34	1.37	1.47	1.49	2.20
13.0	190.74	213.11	214.63	1.74	1.36	1.31	1.43	1.44	2.00
14.0	193.55	218.17	225.44	1.74	1.37	1.27	1.40	1.40	1.85
15.0	195.79	222.07	233.49	1.73	1.39	1.24	1.37	1.37	1.75

\* Normalized at control voltage = 0V

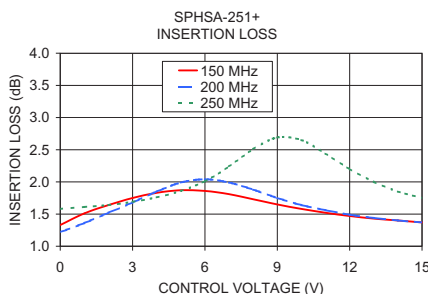
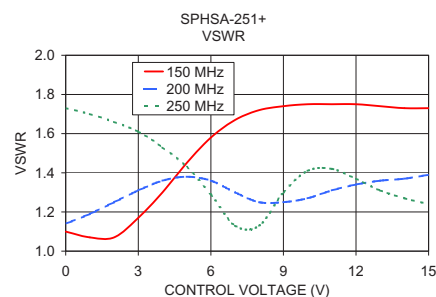
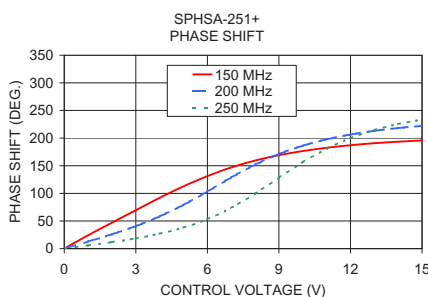

### electrical schematic

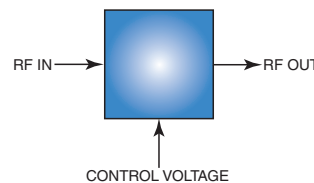

### Notes

- A. Performance and quality attributes and conditions not expressly stated in this specification document are intended to be excluded and do not form a part of this specification document.  
B. Electrical specifications and performance data contained in this specification document are based on Mini-Circuits' applicable established test performance criteria and measurement instructions.  
C. The parts covered by this specification document are subject to Mini-Circuits standard limited warranty and terms and conditions (collectively, "Standard Terms"); Purchasers of this part are entitled to the rights and benefits contained therein. For a full statement of the Standard Terms and the exclusive rights and remedies thereunder, please visit Mini-Circuits' website at [www.minicircuits.com/MCLStore/terms.jsp](http://www.minicircuits.com/MCLStore/terms.jsp)



# PHASE SHIFTER

# SPHSA-251+

## Typical Performance Data

CONTROL VOLTAGE (V)	PHASE SHIFT* (Deg.)			VSWR (:1)			INSERTION LOSS (dB)		
	150 MHz	200 MHz	250 MHz	150 MHz	200 MHz	250 MHz	150 MHz	200 MHz	250 MHz
0.0	0.01	0.01	0.01	1.10	1.14	1.73	1.33	1.22	1.58
1.0	24.23	12.97	5.88	1.07	1.19	1.70	1.51	1.36	1.61
2.0	46.91	25.98	11.76	1.07	1.25	1.66	1.64	1.52	1.64
3.0	69.53	40.70	18.54	1.17	1.31	1.61	1.75	1.68	1.69
4.0	91.78	58.22	27.01	1.30	1.36	1.53	1.83	1.85	1.76
5.0	112.67	79.19	38.16	1.45	1.38	1.43	1.87	1.99	1.86
6.0	131.26	103.36	53.33	1.58	1.36	1.29	1.86	2.04	2.01
7.0	146.85	128.64	73.76	1.67	1.30	1.13	1.81	1.99	2.24
8.0	159.33	151.94	99.51	1.72	1.25	1.13	1.73	1.88	2.51
9.0	169.05	171.21	128.38	1.74	1.25	1.30	1.65	1.75	2.69
10.0	176.58	186.24	156.49	1.75	1.27	1.41	1.58	1.64	2.65
11.0	182.48	197.74	180.79	1.75	1.31	1.42	1.52	1.56	2.44
12.0	187.09	206.48	200.05	1.75	1.34	1.37	1.47	1.49	2.20
13.0	190.71	213.11	214.63	1.74	1.36	1.31	1.43	1.44	2.00
14.0	193.55	218.17	225.44	1.73	1.37	1.27	1.40	1.40	1.85
15.0	195.79	222.07	233.49	1.73	1.39	1.24	1.37	1.37	1.75

\*Normalized at control voltage = 0V

## Typical Performance Curves

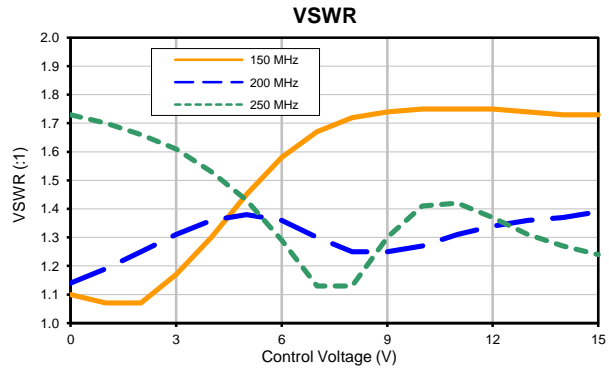
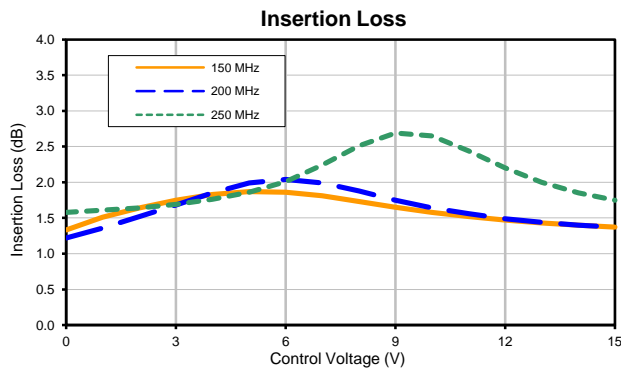
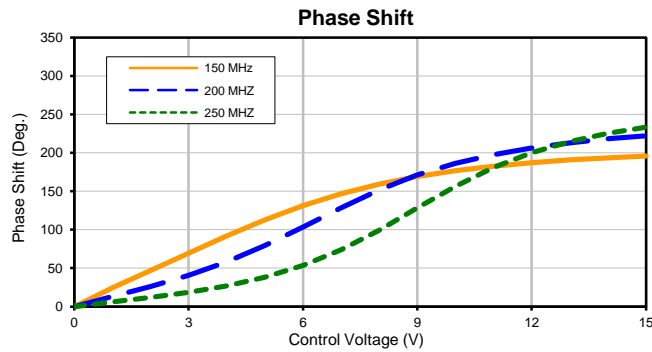

### Outline Dimensions

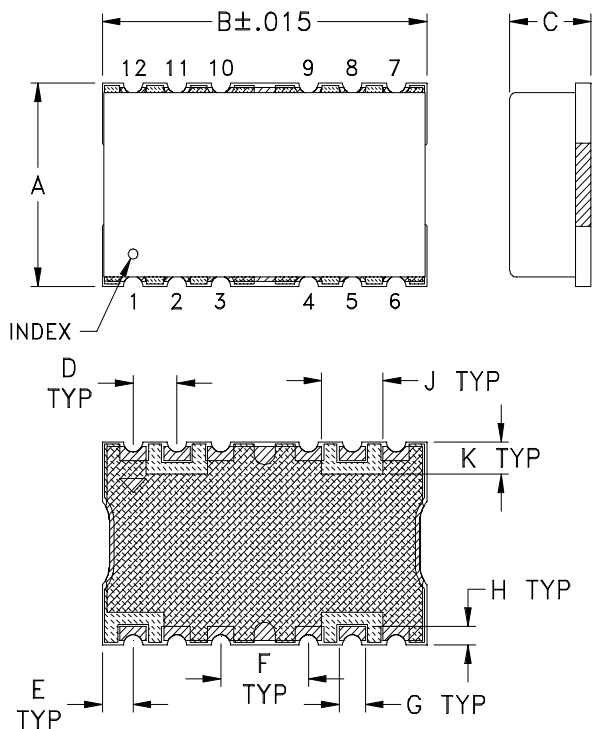

### PCB Land Pattern

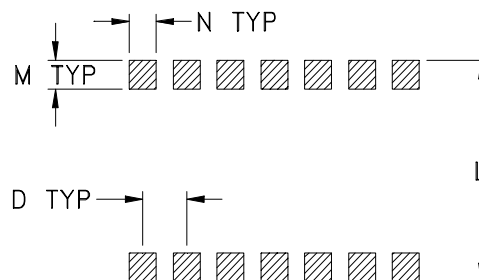

Suggested Layout,  
Tolerance to be within  $\pm .002$

CASE #	A	B	C	D	E	F	G	H	J	K	L	M	N
JW1441	.440 (11.18)	.740 (18.80)	.19 (4.83)	.100 (2.54)	.070 (1.78)	.200 (5.08)	.060 (1.52)	.040 (1.02)	.140 (3.56)	.070 (1.78)	.480 (12.19)	.063 (1.60)	.061 (1.55)

CASE #	P	WT. GRAM
JW1441	--	2.5

Dimensions are in inches (mm). Tolerances: 2 Pl.  $\pm .03$ ; 3Pl.  $\pm .015$

#### Notes:

1. Case material: Nickel-Silver alloy.
2. Base: Printed wiring laminate.
3. Termination finish:  
For RoHS Case Styles: Gold over Nickel plate.  
For RoHS-5 Case Styles: Tin-Lead plate.

# Tape & Reel Packaging TR-F5

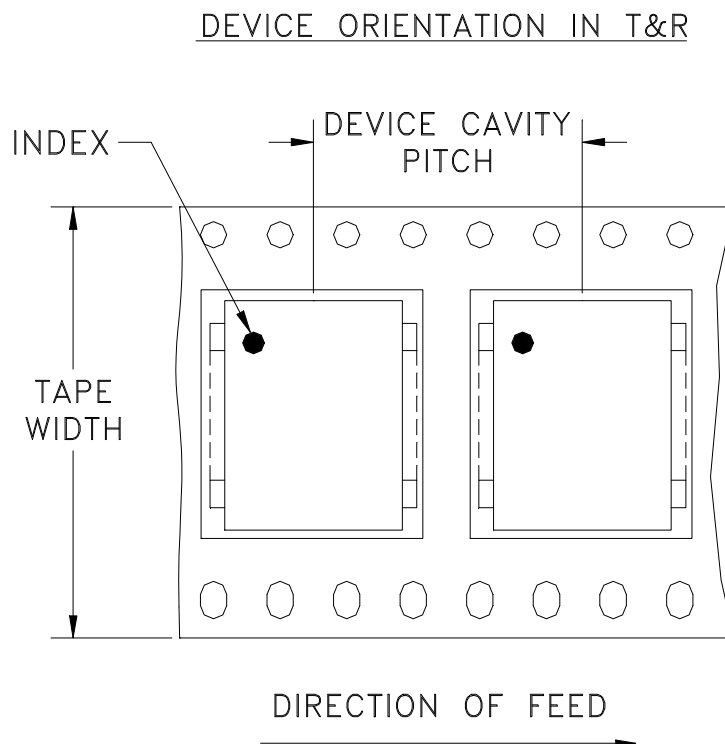

Tape Width, mm	Device Cavity Pitch, mm	Reel Size, inches	Devices per Reel
32	16	13	500

Mini-Circuits carrier tape materials provide protection from ESD (Electro-Static Discharge) during handling and transportation. Tapes are static dissipative and comply with industry standards EIA-481/EIA-541.

Go to: [www.minicircuits.com/pages/pdfs/tape.pdf](http://www.minicircuits.com/pages/pdfs/tape.pdf)



**Distribution Centers** NORTH AMERICA 800-654-7949 • 417-335-5935 • Fax 417-335-5945 • EUROPE 44-1252-832600 • Fax 44-1252-837010

Mini-Circuits ISO 9001 & ISO 14001 Certified

INTERNET <http://www.minicircuits.com>

P.O. Box 350166, Brooklyn, New York 11235-0003 (718) 934-4500 Fax (718) 332-4661

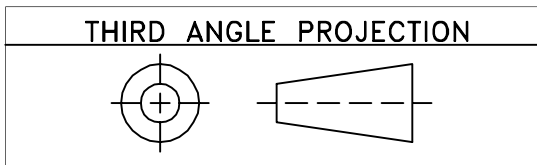

REVISIONS					
REV OR	ECN No.	DESCRIPTION	DATE	DR	AUTH
	M144558	NEW RELEASE	01/22/14	AV	PW

**SUGGESTED MOUNTING CONFIGURATION FOR JW1441 CASE STYLE, "12PS01" PIN CODE**

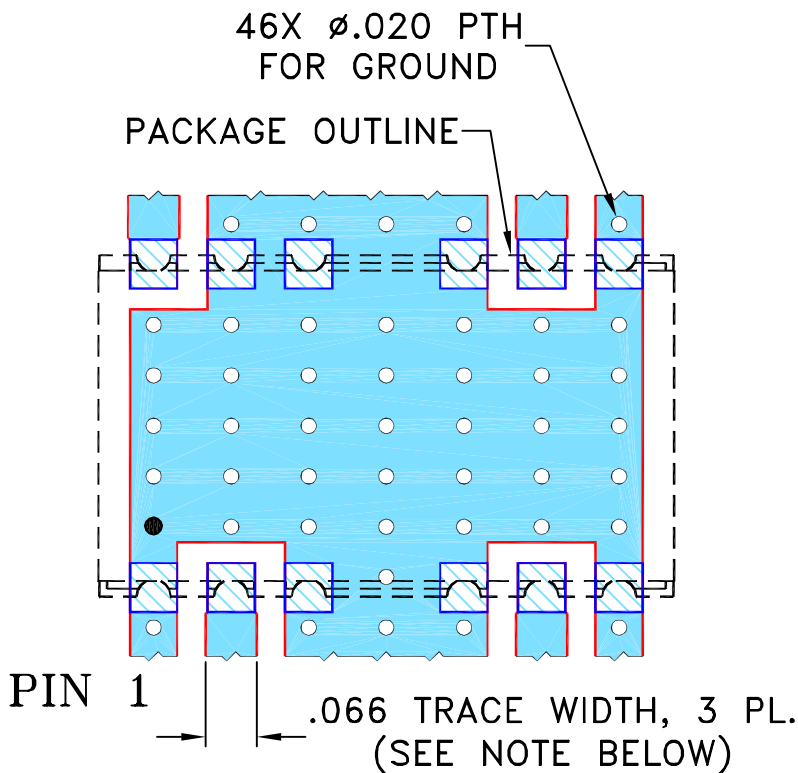

- NOTES: 1. TRACE WIDTH IS SHOWN FOR ROGERS RO4350 WITH DIELECTRIC THICKNESS .030" ± .002"; COPPER: 1/2 OZ. EACH SIDE. FOR OTHER MATERIALS TRACE WIDTH MAY NEED TO BE MODIFIED.  
 2. BOTTOM SIDE OF THE PCB IS CONTINUOUS GROUND PLANE.

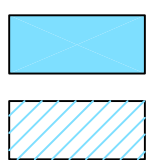

DENOTES PCB COPPER LAYOUT WITH SMOBC (SOLDER MASK OVER BARE COPPER)

DENOTES COPPER LAND PATTERN FREE OF SOLDER MASK

UNLESS OTHERWISE SPECIFIED	INITIALS	DATE
DIMENSIONS ARE IN INCHES	DRAWN AV	01/14/14
TOLERANCES ON:	CHECKED IL	01/22/14
2 PL DECIMALS ±	APPROVED PW	01/22/14
3 PL DECIMALS ± .005		
ANGLES ±		
FRACTIONS ±		



Mini-Circuits®

13 Neptune Avenue  
Brooklyn NY 11235

PL, 12PS01, JW1441, TB-524+

Mini-Circuits®  
 THIS DOCUMENT AND ITS CONTENTS ARE THE PROPERTY OF MINI-CIRCUITS. EXCEPT FOR USE EXPRESSLY GRANTED, IN WRITING, TO ITS VENDORS, VENDEE AND THE UNITED STATES GOVERNMENT, MINI-CIRCUITS RESERVES ALL PROPRIETARY DESIGN, USE, MANUFACTURING AND REPRODUCTION RIGHTS THERETO. THESE CONTENTS SHALL NOT BE USED, DUPLICATED OR DISCLOSED TO ANY OUTSIDE PARTY, IN WHOLE OR IN PART, WITHOUT WRITTEN PERMISSION OF MINI-CIRCUITS.

ASHEETA1.DWG REV:A DATE:01/12/95

SIZE	CODE IDENT	DRAWING NO:	REV:
A	15542	98-PL-408	OR
FILE:	98PL408	SCALE: 4:1	SHEET: 1 OF 1

# Evaluation Board and Circuit

For Pin Connection Refer to Data Sheet of the DUT

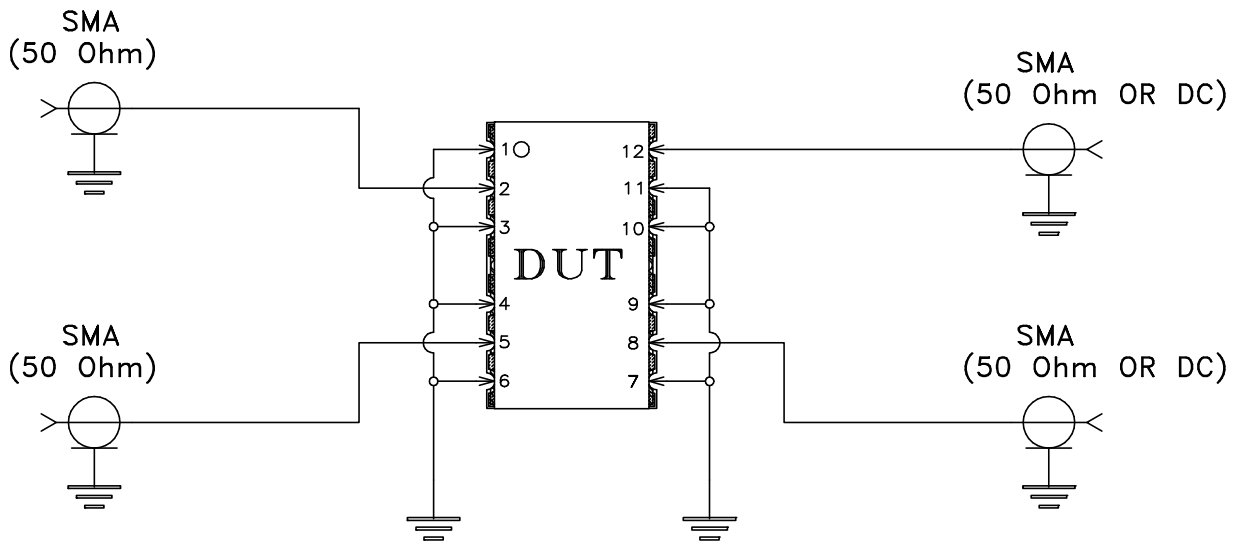
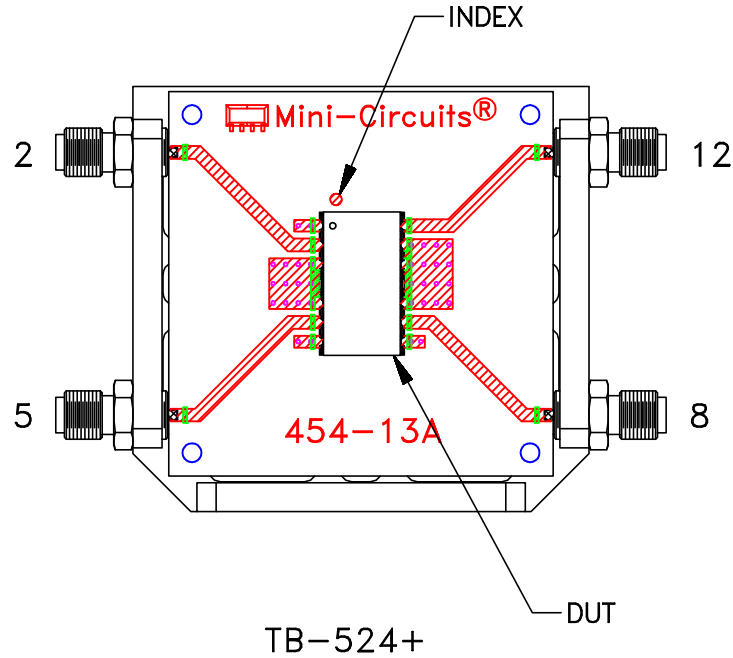

## Schematic Diagram

### Notes:

1. 50 Ohm SMA Female connectors.
2. PCB Material: Rogers R04350 or equivalent, Dielectric Constant=3.5, Thickness=.030 inch.

 **Mini-Circuits®**





All Mini-Circuits products are manufactured under exacting quality assurance and control standards, and are capable of meeting published specifications after being subjected to any or all of the following physical and environmental test.

Specification	Test/Inspection Condition	Reference/Spec
Operating Temperature	-40° to 85°C Ambient Environment	Individual Model Data Sheet
Storage Temperature	-55° to 100° C Ambient Environment	Individual Model Data Sheet
Humidity	90 to 95% RH, 240 hours, 50°C	MIL-STD-202, Method 103, Condition A, Except 50°C and end-point electrical test done within 12 hours
Thermal Shock	-55° to 100°C, 100 cycles	MIL-STD-202, Method 107, Condition A-3, except +100°C
Solder Reflow Heat	Sn-Pb Eutetic Process: 225°C peak Pb-Free Process 245° - 250°C peak	J-STD-020, Table 4-1, 4-2 and 5-2, Figure 5-1
Solderability	10X Magnification	J-STD-002, 95% Coverage
Vibration (High Frequency)	20g peak, 10-2000 Hz, 12 times in each of three perpendicular directions (total 36)	MIL-STD-202, Method 204, Condition D
Mechanical Shock	50g, 11 ms, 1/2-sine, 18 shocks: 3 each direction, each of 3 axes	MIL-STD-202, Method 213, Condition A
Marking Resistance to Solvents	Isopropyl alcohol + mineral spirits at 25°C; terpene defluxer at 25°C; distilled water + proylene glycol monomethyl ether + monoethanolamine at 63°C to 70°C	MIL-STD-202, Method 215