

Surface Mount

Bandpass Filter

SXBP-404+

50Ω

398 to 410 MHz

The Big Deal

- Flat group delay (3ns typical)
- Narrow band (<3% fractional Bandwidth)
- High rejection (50dB typical)
- Fast roll-off
- Miniature shielded package



CASE STYLE: HF1139

Product Overview

The SXBP-404+ is a narrow-band bandpass filter fabricated using SMT technology. Covering 404 MHz ± 6 MHz, these units offer good matching within the passband and high rejection. This unit uses a miniature high Q capacitors and wire welded inductors for high reliability. It has repeatable performance across production lots and consistent performance across temperature.

Key Features

Feature	Advantages
Narrow bandwidth filter (fractional bandwidth of < 3%)	This enables the filter to reject adjacent channels with increased selectivity.
More than 40dB rejection up to 2400MHz	This enables the filter to attenuate spurious signals and reject harmonics for broad band of frequency.
Flat group delay (3 ns typical)	This model has flat group delay of 3nsec which helps in reducing the signal distortion.
Small size, 0.44" x 0.74" x 0.27"	The surface mount package enables the SXBP-404+ to be used in compact designs.

Notes

- A. Performance and quality attributes and conditions not expressly stated in this specification document are intended to be excluded and do not form a part of this specification document.
B. Electrical specifications and performance data contained in this specification document are based on Mini-Circuit's applicable established test performance criteria and measurement instructions.
C. The parts covered by this specification document are subject to Mini-Circuits standard limited warranty and terms and conditions (collectively, "Standard Terms"); Purchasers of this part are entitled to the rights and benefits contained therein. For a full statement of the Standard Terms and the exclusive rights and remedies thereunder, please visit Mini-Circuits' website at www.minicircuits.com/MCLStore/terms.jsp



Bandpass Filter

SXBP-404+

50Ω 398 to 410 MHz



CASE STYLE: HF1139

Features

- Flat group delay over passband
- High rejection, (50 dB typical)
- Shielded case
- Aqueous washable

Applications

- Test equipments
- Receivers / transmitters
- Harmonic rejection
- Military

Electrical Specifications at 25°C

Parameter	F#	Frequency (MHz)	Min.	Typ.	Max.	Unit	
Pass Band	Center Frequency	—	—	404	—	MHz	
	Insertion Loss	F1-F2	398-410	—	4.1	5.5	dB
	VSWR	F1-F2	398-410	—	1.5	2.0	:1
Stop Band, Lower	Insertion Loss	DC-F3	DC-370	20	31	—	dB
	VSWR	DC-F3	DC-370	—	24	—	:1
Stop Band, Upper	Insertion Loss	F4-F5	445-4500	20	32	—	dB
	VSWR	F4-F5	445-4500	—	19	—	:1

Maximum Ratings

Operating Temperature	-40°C to 85°C
Storage Temperature	-55°C to 100°C
RF Power Input	0.25W max.

Permanent damage may occur if any of these limits are exceeded.

Functional Schematic

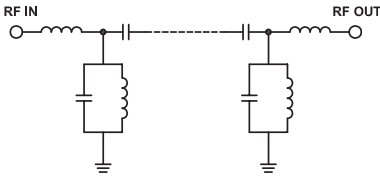

Typical Frequency Response

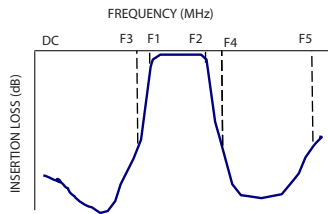

Typical Performance Data at 25°C

Frequency (MHz)	Insertion Loss (dB)	VSWR (:1)	Frequency (MHz)	Group Delay (nsec)
1.0	83.12	133.63	398.00	28.98
326.0	67.26	108.58	399.00	28.55
350.0	50.91	66.82	400.00	28.22
370.0	32.52	25.94	401.00	27.95
379.0	20.75	10.25	402.00	27.73
386.0	9.82	2.50	402.50	27.64
393.0	4.96	1.58	403.00	27.56
398.0	4.12	1.50	403.50	27.48
404.0	3.69	1.16	404.00	27.42
410.0	3.84	1.09	404.50	27.36
420.0	6.24	2.26	405.00	27.31
426.0	12.13	5.66	405.50	27.29
445.0	32.95	25.94	406.00	27.27
500.0	62.04	78.97	406.50	27.26
700.0	85.57	124.09	407.00	27.27
1000.0	79.97	86.86	407.50	27.29
2000.0	64.54	59.91	408.00	27.33
3000.0	41.90	40.41	408.50	27.39
4000.0	44.13	26.74	409.00	27.46
4500.0	45.71	24.48	410.00	27.66

+RoHS Compliant

The +Suffix identifies RoHS Compliance. See our web site for RoHS Compliance methodologies and qualifications

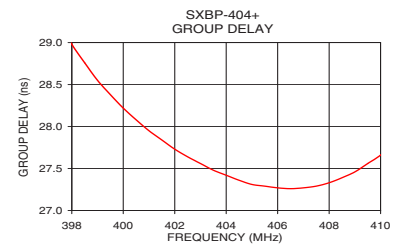
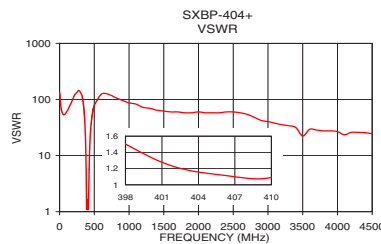
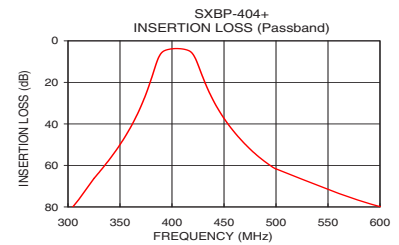
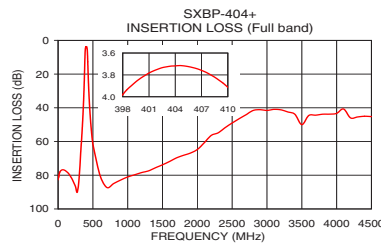

Notes

- Performance and quality attributes and conditions not expressly stated in this specification document are intended to be excluded and do not form a part of this specification document.
- Electrical specifications and performance data contained in this specification document are based on Mini-Circuit's applicable established test performance criteria and measurement instructions.
- The parts covered by this specification document are subject to Mini-Circuits standard limited warranty and terms and conditions (collectively, "Standard Terms"); Purchasers of this part are entitled to the rights and benefits contained therein. For a full statement of the Standard Terms and the exclusive rights and remedies thereunder, please visit Mini-Circuits' website at www.minicircuits.com/MCLStore/terms.jsp



Pad Connections

INPUT	1
OUTPUT	8
GROUND	2,3,4,5,6,7

Demo Board MCL P/N: TB-368 Suggested PCB Layout (PL-230)

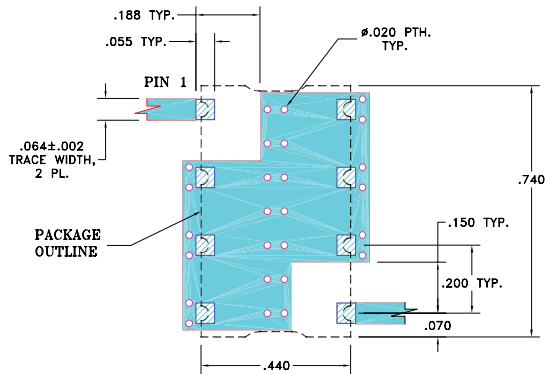

NOTE:

- TRACE WIDTH IS SHOWN FOR FR4 WITH DIELECTRIC THICKNESS: .025"±.002". COPPER: 1/2 OZ. EACH SIDE. FOR OTHER MATERIALS TRACE WIDTH MAY NEED TO BE MODIFIED.
- BOTTOM SIDE OF THE PCB IS CONTINUOUS GROUND PLANE.

- DENOTES PCB COPPER LAYOUT WITH SMOBC (SOLDER MASK OVER BARE COPPER)
- DENOTES COPPER LAND PATTERN FREE OF SOLDER MASK

Outline Drawing

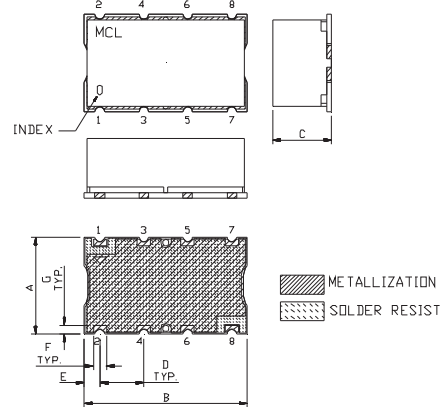

PCB Land Pattern

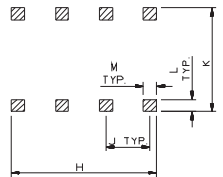

Outline Dimensions (inch/mm)

A	B	C	D	E	F	G
.44	.74	.27	.200	.07	.060	.040
11.18	18.80	6.86	5.08	1.78	1.52	1.02
H	J	K	L	M	wt	
.660	.200	.470	.055	.060	grams	
16.76	5.08	11.94	1.40	1.52	3.0	

Notes

- Performance and quality attributes and conditions not expressly stated in this specification document are intended to be excluded and do not form a part of this specification document.
- Electrical specifications and performance data contained in this specification document are based on Mini-Circuit's applicable established test performance criteria and measurement instructions.
- The parts covered by this specification document are subject to Mini-Circuits standard limited warranty and terms and conditions (collectively, "Standard Terms"); Purchasers of this part are entitled to the rights and benefits contained therein. For a full statement of the Standard Terms and the exclusive rights and remedies thereunder, please visit Mini-Circuits' website at www.minicircuits.com/MCLStore/terms.jsp

Typical Performance Data

FREQ. (MHz)	INSERTION LOSS			INPUT RETURN LOSS			OUTPUT RETURN LOSS		
	(dB)			(dB)			(dB)		
	@-40°C	@+25°C	@+85°C	@-40°C	@+25°C	@+85°C	@-40°C	@+25°C	@+85°C
1.0	112.04	96.78	112.77	0.08	0.10	0.13	0.08	0.11	0.13
5.0	103.28	94.01	96.30	0.09	0.12	0.15	0.09	0.12	0.15
10.0	93.62	91.64	91.87	0.12	0.15	0.17	0.11	0.15	0.17
100.0	79.61	80.42	80.74	0.22	0.25	0.28	0.21	0.25	0.28
200.0	84.28	84.78	84.46	0.12	0.15	0.18	0.10	0.15	0.17
250.0	88.68	86.46	89.79	0.09	0.13	0.15	0.07	0.12	0.14
300.0	82.28	81.61	80.02	0.09	0.12	0.15	0.06	0.12	0.14
350.0	50.55	50.01	49.36	0.19	0.26	0.31	0.14	0.23	0.27
360.0	42.39	41.72	40.97	0.29	0.39	0.46	0.22	0.34	0.40
362.0	40.58	39.86	39.09	0.32	0.43	0.51	0.24	0.37	0.44
364.0	38.66	37.92	37.11	0.36	0.48	0.57	0.27	0.41	0.48
365.0	37.68	36.92	36.10	0.38	0.51	0.61	0.29	0.43	0.51
366.0	36.67	35.90	35.06	0.41	0.54	0.65	0.31	0.45	0.54
368.0	34.58	33.77	32.90	0.47	0.62	0.74	0.35	0.51	0.61
370.0	32.38	31.54	30.62	0.54	0.71	0.86	0.41	0.59	0.70
372.0	30.05	29.18	28.21	0.63	0.84	1.01	0.48	0.68	0.82
374.0	27.60	26.67	25.67	0.76	1.00	1.22	0.57	0.81	0.98
376.0	24.98	24.03	22.98	0.93	1.23	1.51	0.70	0.98	1.20
378.0	22.20	21.21	20.14	1.17	1.56	1.93	0.89	1.23	1.52
380.0	19.24	18.25	17.17	1.53	2.06	2.58	1.16	1.61	2.02
382.0	16.12	15.17	14.14	2.10	2.86	3.64	1.60	2.22	2.82
384.0	12.91	12.09	11.22	3.08	4.23	5.45	2.35	3.26	4.18
386.0	9.80	9.27	8.69	4.88	6.67	8.59	3.73	5.08	6.45
388.0	7.16	7.04	6.84	8.24	11.03	13.88	6.20	8.04	9.76
390.0	5.33	5.60	5.70	14.47	18.32	20.80	10.07	11.93	13.32
392.0	4.32	4.80	5.05	24.77	23.48	21.85	14.30	15.08	15.50
394.0	3.80	4.35	4.67	23.24	21.92	21.78	16.53	16.51	16.57
396.0	3.50	4.07	4.43	22.56	23.47	24.85	17.51	17.53	17.65
398.0	3.32	3.90	4.27	26.45	29.70	33.63	18.57	18.67	18.89
399.0	3.25	3.84	4.21	30.69	36.67	39.57	19.10	19.24	19.57
400.0	3.20	3.79	4.17	35.75	36.84	32.71	19.57	19.81	20.35
401.0	3.16	3.75	4.15	32.52	30.36	28.18	19.99	20.44	21.31
402.0	3.13	3.73	4.13	28.11	26.73	25.42	20.47	21.29	22.64
403.0	3.11	3.71	4.12	25.38	24.49	23.54	21.13	22.47	24.56
404.0	3.09	3.71	4.13	23.63	22.94	22.09	22.17	24.28	27.60
405.0	3.09	3.72	4.15	22.41	21.72	20.85	23.83	27.21	33.04
406.0	3.10	3.73	4.18	21.45	20.64	19.68	26.52	32.48	38.92
407.0	3.11	3.76	4.23	20.53	19.56	18.56	30.96	37.99	30.36
408.0	3.14	3.81	4.29	19.52	18.45	17.47	33.95	29.82	25.27
409.0	3.18	3.86	4.36	18.40	17.34	16.47	28.30	24.74	22.15
410.0	3.23	3.93	4.45	17.23	16.29	15.59	23.73	21.58	20.09
412.0	3.38	4.12	4.67	15.13	14.60	14.27	18.66	18.14	18.06
416.0	3.81	4.71	5.49	13.12	12.99	12.49	17.04	19.18	21.19
420.0	4.92	6.40	7.80	10.61	8.88	7.41	19.05	13.90	10.76
424.0	8.48	10.52	12.32	4.62	4.03	3.55	6.17	5.37	4.66
426.0	11.14	13.17	14.93	3.02	2.82	2.61	3.90	3.67	3.35
430.0	16.71	18.48	20.03	1.58	1.64	1.63	1.96	2.06	2.02
432.0	19.32	20.95	22.38	1.24	1.34	1.36	1.52	1.65	1.66
434.0	21.78	23.28	24.61	1.02	1.13	1.17	1.22	1.37	1.41
436.0	24.07	25.46	26.70	0.87	0.97	1.02	1.02	1.17	1.22
440.0	28.23	29.44	30.52	0.66	0.76	0.82	0.75	0.89	0.95
442.0	30.12	31.26	32.28	0.59	0.69	0.74	0.66	0.80	0.86
444.0	31.90	32.98	33.95	0.53	0.63	0.68	0.58	0.72	0.78
445.0	32.75	33.80	34.75	0.51	0.60	0.66	0.55	0.69	0.74
447.0	34.40	35.40	36.29	0.47	0.56	0.61	0.50	0.63	0.68
450.0	36.71	37.65	38.49	0.41	0.50	0.55	0.43	0.56	0.61
460.0	43.40	44.18	44.88	0.30	0.37	0.41	0.29	0.40	0.45
480.0	53.66	54.31	54.93	0.20	0.26	0.29	0.17	0.26	0.30
500.0	61.72	62.31	62.70	0.15	0.20	0.23	0.11	0.20	0.23
600.0	94.55	93.54	95.91	0.08	0.12	0.15	0.03	0.12	0.14
700.0	91.17	91.53	91.21	0.06	0.11	0.14	0.01	0.10	0.13
800.0	93.16	91.07	98.80	0.06	0.11	0.14	0.00	0.10	0.13
900.0	97.91	103.69	104.59	0.06	0.12	0.15	0.00	0.11	0.14
1000.0	98.58	101.04	98.76	0.07	0.12	0.16	0.00	0.11	0.15
1500.0	79.44	77.58	81.51	0.10	0.17	0.21	0.01	0.16	0.20
2000.0	71.19	70.28	65.68	0.14	0.23	0.28	0.02	0.21	0.27
2500.0	56.94	55.75	56.41	0.17	0.29	0.35	0.03	0.25	0.33
3000.0	50.28	48.53	49.82	0.22	0.37	0.43	0.08	0.31	0.44
3500.0	37.81	37.42	39.03	0.26	0.42	0.52	0.11	0.39	0.53
4000.0	31.18	32.02	32.28	0.38	0.68	0.72	0.31	0.65	0.70
4500.0	22.26	23.68	24.01	1.20	1.37	1.46	0.56	1.05	1.25

Typical Performance Data

FREQ. (MHz)	GROUP DELAY		
	(nsec)		
	@-40°C	@+25°C	@+85°C
398.0	29.86	29.11	28.19
398.5	29.48	28.80	28.01
399.0	29.14	28.53	27.82
399.5	28.83	28.29	27.62
400.0	28.56	28.07	27.52
400.5	28.31	27.88	27.37
401.0	28.09	27.71	27.21
401.5	27.89	27.55	27.02
402.0	27.71	27.42	27.03
402.5	27.56	27.31	26.94
403.0	27.44	27.21	26.92
403.5	27.32	27.13	26.82
404.0	27.22	27.07	26.82
404.5	27.14	27.02	26.85
405.0	27.08	26.98	26.71
405.5	27.04	26.96	26.85
406.0	27.01	26.97	26.79
406.5	26.99	26.98	26.90
407.0	26.99	27.00	27.00
407.5	27.00	27.04	26.87
408.0	27.03	27.09	27.09
408.5	27.07	27.17	27.17
409.0	27.12	27.25	27.20
409.5	27.19	27.36	27.41
410.0	27.28	27.49	27.48

Typical Performance Curves

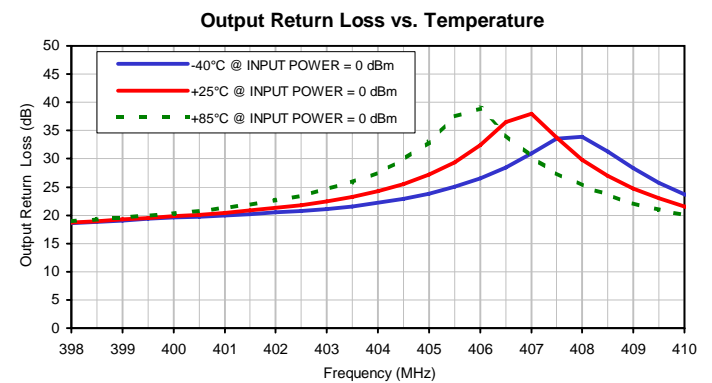
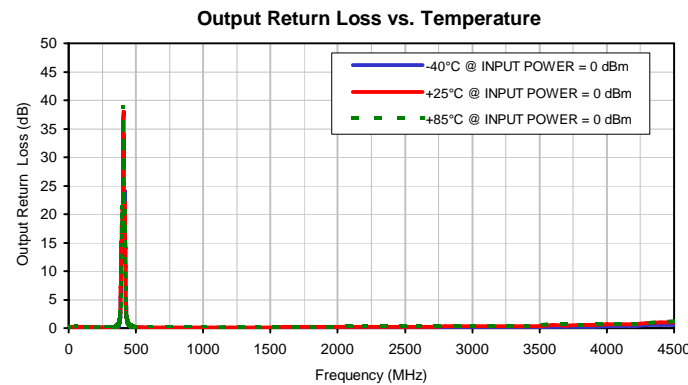
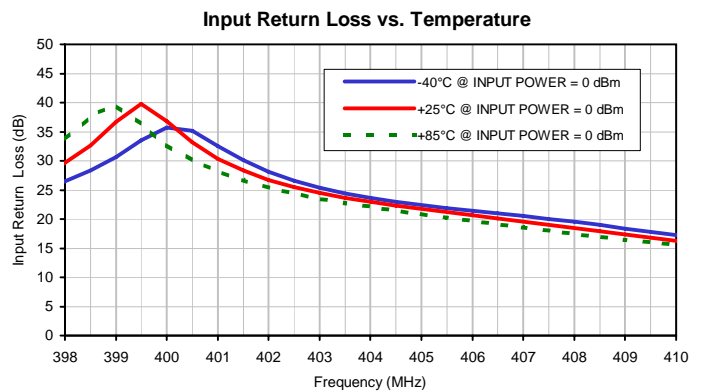
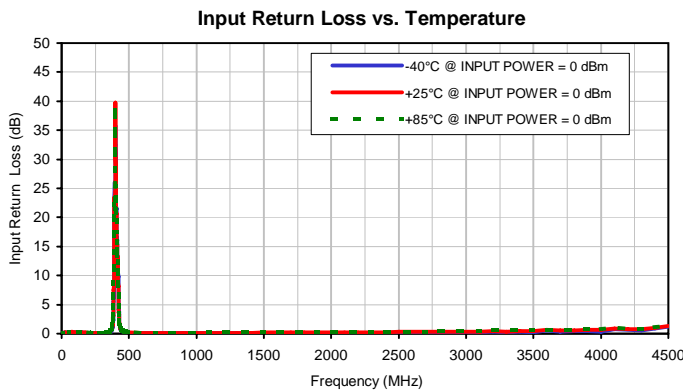
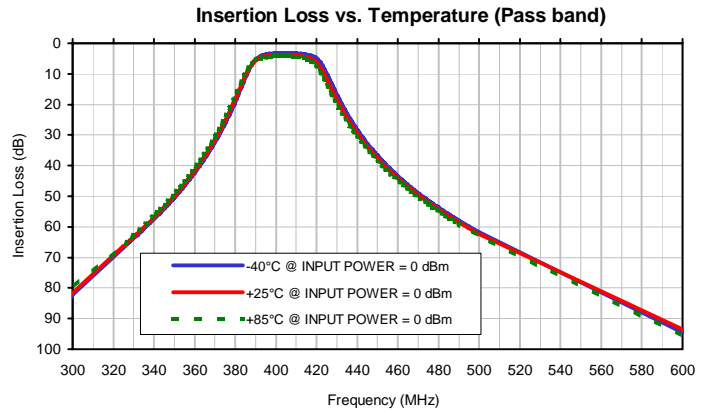
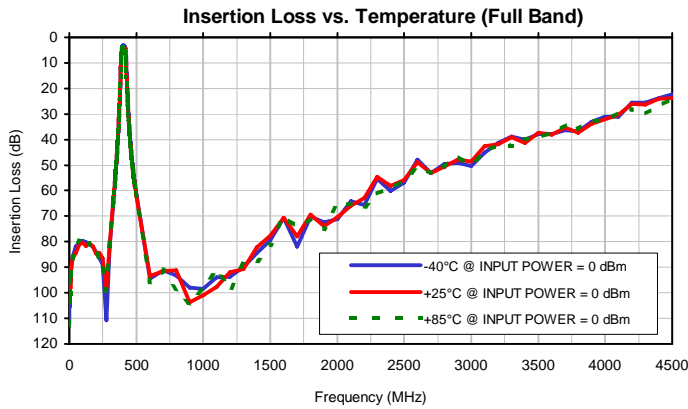

Typical Performance Curves

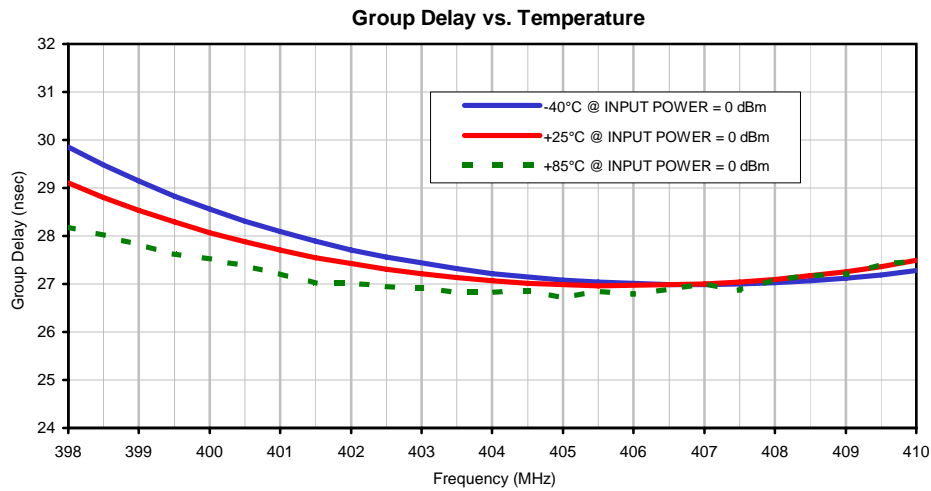

Outline Dimensions

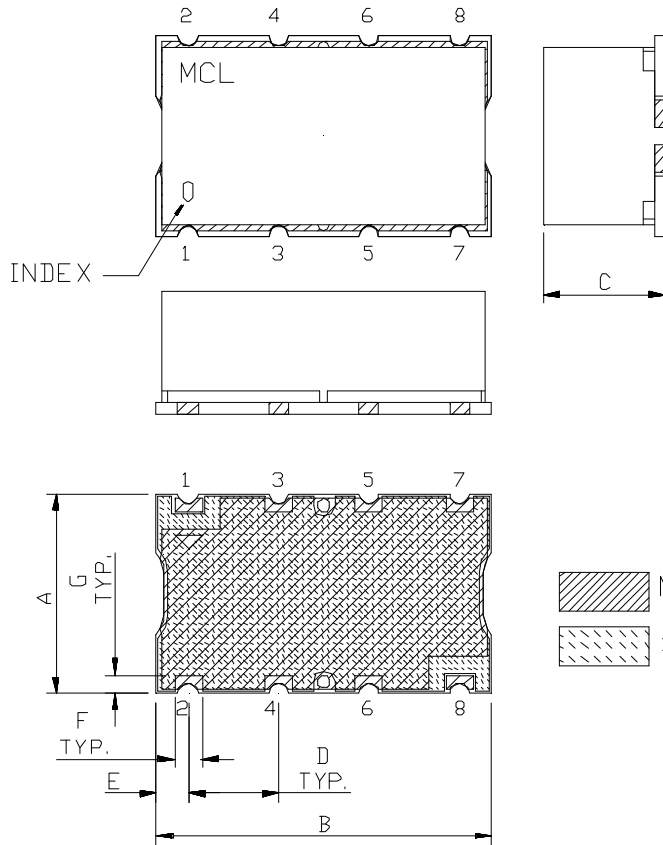

PCB Land Pattern

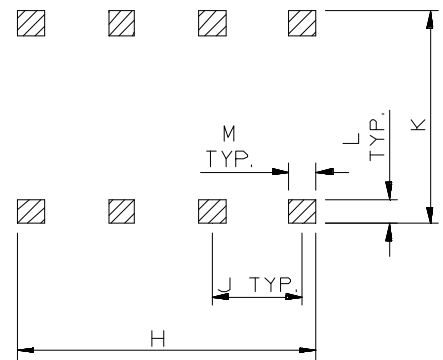

CASE #	A	B	C	D	E	F	G	H	J	K	L	M	WT. GRAMS
HF1139	.44 (11.18)	.74 (18.80)	.27 (6.86)	.200 (5.08)	.07 (1.78)	.060 (1.52)	.040 (1.02)	.660 (16.76)	.200 (5.08)	.470 (11.94)	.055 (1.40)	.060 (1.52)	3.0

Dimensions are in inches (mm). Tolerances: 2 Pl. ± 0.015 "; 3 Pl. ± 0.01 "

Notes:

- Case material: Nickel-Silver alloy.
- Base: Printed wiring laminate.
- Termination finish:
 - For RoHS Case Styles: 2-5 μ inch (.05-.13 microns) Gold over 120-240 μ inch (3.05-6.10 microns) Nickel plate.
 - For RoHS-5 Case Styles: Tin-Lead plate.



P.O. Box 350166, Brooklyn, New York 11235-0003 (718) 934-4500 Fax (718) 332-4661 For detailed performance specs & shopping online see Mini-Circuits web site



The Design Engineers Search Engine Provides ACTUAL Data Instantly From MINI-CIRCUITS At: www.minicircuits.com

RF/IF MICROWAVE COMPONENTS

Tape & Reel Packaging TR-F5

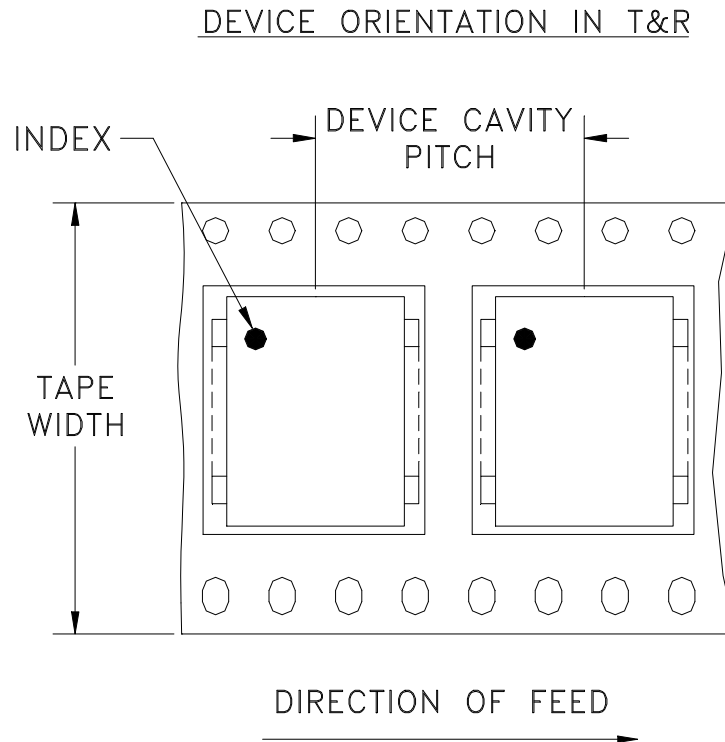

Tape Width, mm	Device Cavity Pitch, mm	Reel Size, inches	Devices per Reel
32	16	13	500

Mini-Circuits carrier tape materials provide protection from ESD (Electro-Static Discharge) during handling and transportation. Tapes are static dissipative and comply with industry standards EIA-481/EIA-541.

Go to: www.minicircuits.com/pages/pdfs/tape.pdf



Distribution Centers NORTH AMERICA 800-654-7949 • 417-335-5935 • Fax 417-335-5945 • EUROPE 44-1252-832600 • Fax 44-1252-837010

Mini-Circuits ISO 9001 & ISO 14001 Certified

INTERNET <http://www.minicircuits.com>

P.O. Box 350166, Brooklyn, New York 11235-0003 (718) 934-4500 Fax (718) 332-4661

THIRD ANGLE PROJECTION

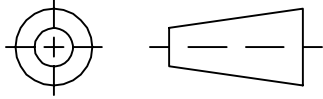

REVISIONS

REV	ECN No.	DESCRIPTION	DATE	DR	AUTH
OR	M101757	NEW RELEASE (FROM RAVON)	11/05	DK	HH
OR	R62293	NEW RELEASE (FROM RAVON)	11/05	DK	HH

**SUGGESTED MOUNTING CONFIGURATION
FOR HF1139 CASE STYLE, cr PIN CONNECTION, 50 OHM.**

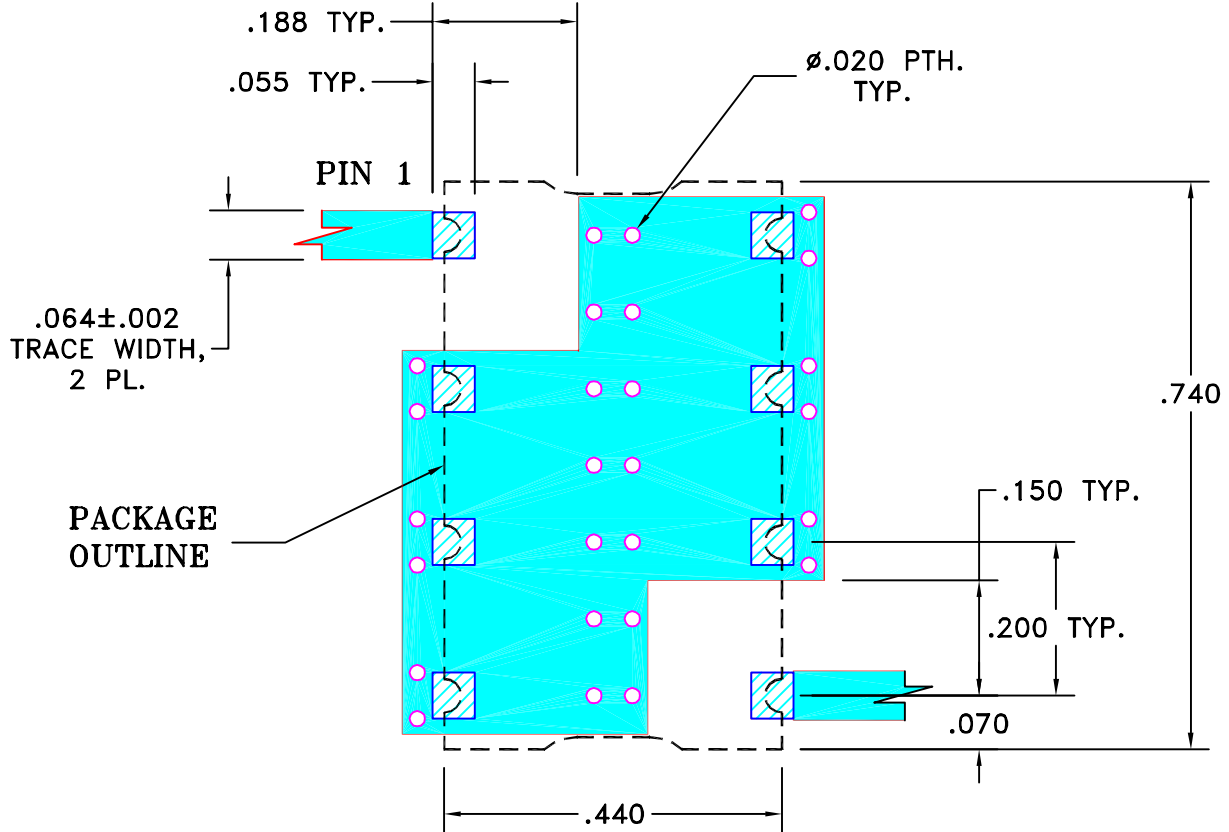

NOTE:

- TRACE WIDTH IS SHOWN FOR FR4 WITH DIELECTRIC THICKNESS: .025"±.002". COPPER: 1/2 OZ. EACH SIDE. FOR OTHER MATERIALS TRACE WIDTH MAY NEED TO BE MODIFIED.
- BOTTOM SIDE OF THE PCB IS CONTINUOUS GROUND PLANE.

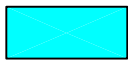

DENOTES PCB COPPER LAYOUT WITH SMOBC (SOLDER MASK OVER BARE COPPER)

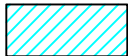

DENOTES COPPER LAND PATTERN FREE OF SOLDER MASK

UNLESS OTHERWISE SPECIFIED	INITIALS		DATE
DIMENSIONS ARE IN INCHES TOLERANCES ON: 2 PL DECIMALS ± 3 PL DECIMALS ± .005 ANGLES ± FRACTIONS ±	DRAWN	DK (RAVON)	29 NOV 05
	CHECKED	RZ (RAVON)	29 NOV 05
	APPROVED	HH (RAVON)	29 NOV 05



Mini-Circuits®

13 Neptune Avenue
Brooklyn NY 11235

PL, cr, HF1139, SCLF, TB-368

Mini-Circuits®
THIS DOCUMENT AND ITS CONTENTS ARE THE PROPERTY OF MINI-CIRCUITS. EXCEPT FOR USE EXPRESSLY GRANTED, IN WRITING, TO ITS VENDORS, VENDEE AND THE UNITED STATES GOVERNMENT, MINI-CIRCUITS RESERVES ALL PROPRIETARY DESIGN, USE, MANUFACTURING AND REPRODUCTION RIGHTS THERETO. THESE CONTENTS SHALL NOT BE USED, DUPLICATED OR DISCLOSED TO ANY OUTSIDE PARTY, IN WHOLE OR IN PART, WITHOUT WRITTEN PERMISSION OF MINI-CIRCUITS.

SIZE A	CODE IDENT 15542	DRAWING NO: 98-PL-230	REV: OR
FILE: 98PL230	SCALE: 4:1	SHEET: 1 OF 1	

Evaluation Board and Circuit

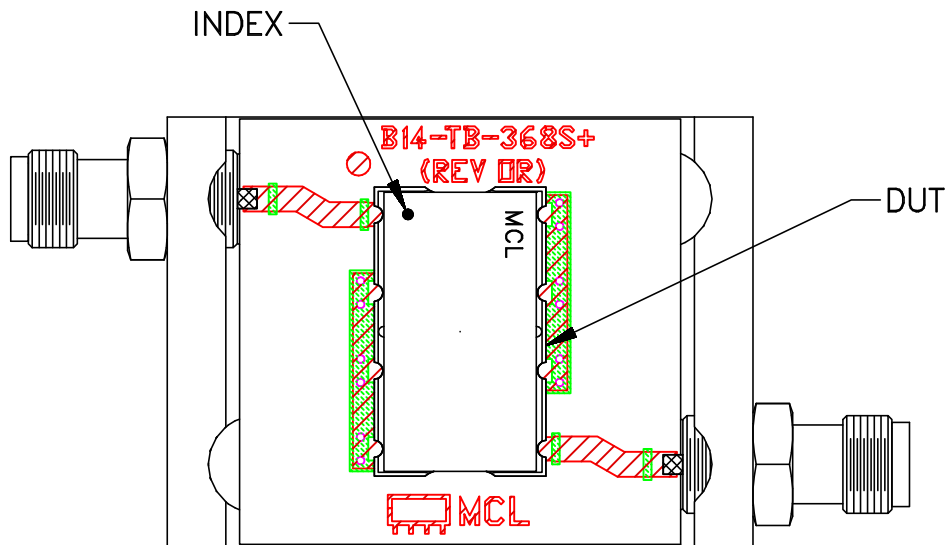

TB-368

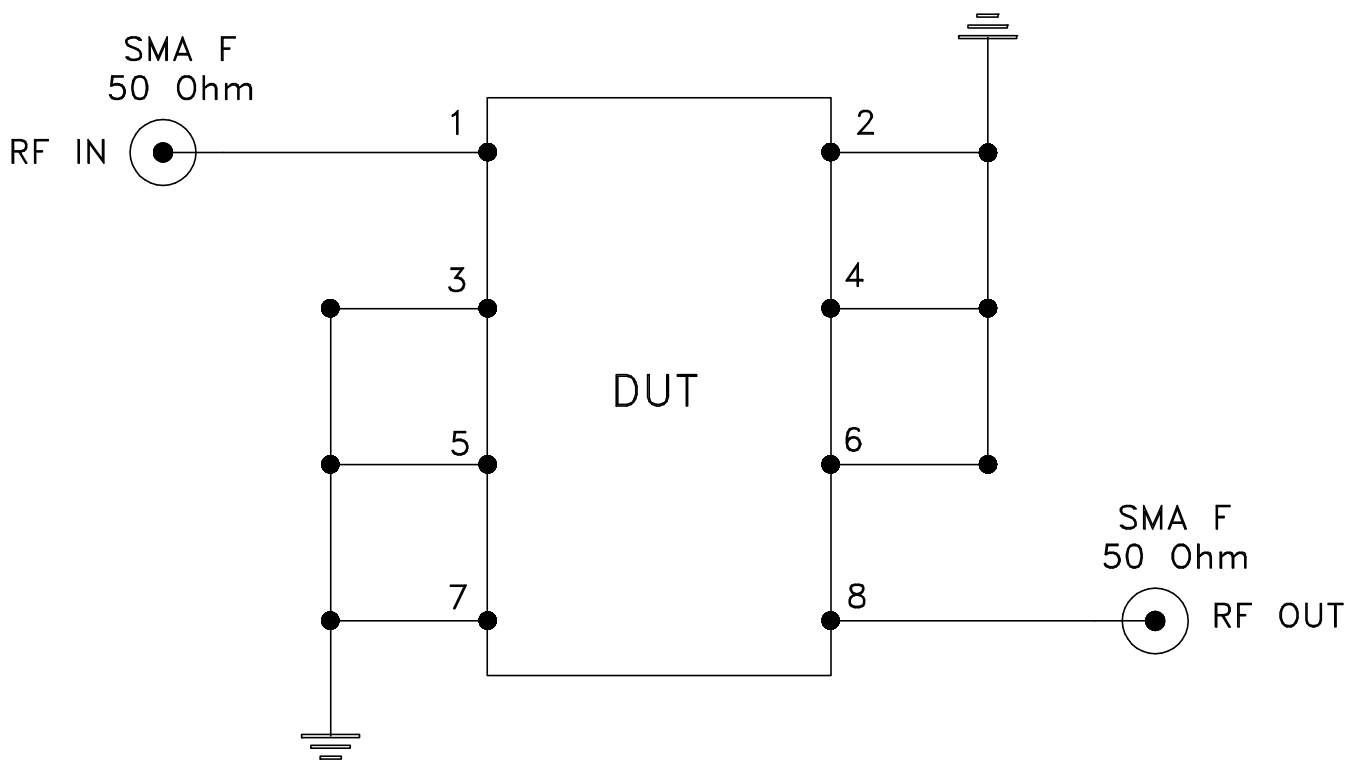

Schematic Diagram

Notes:

1. SMA Female connectors.
2. PCB Material: ROGERS R04350B or equivalent, Dielectric Constant=3.5, Thickness=.030 inch.

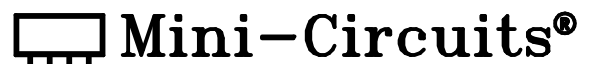

All Mini-Circuits products are manufactured under exacting quality assurance and control standards, and are capable of meeting published specifications after being subjected to any or all of the following physical and environmental test.

Specification	Test/Inspection Condition	Reference/Spec
Operating Temperature	-40° to 85°C Ambient Environment	Individual Model Data Sheet
Storage Temperature	-55° to 100° C Ambient Environment	Individual Model Data Sheet
Humidity	90 to 95% RH, 240 hours, 50°C	MIL-STD-202, Method 103, Condition A, Except 50°C and end-point electrical test done within 12 hours
Thermal Shock	-55° to 100°C, 100 cycles	MIL-STD-202, Method 107, Condition A-3, except +100°C
Solder Reflow Heat	Sn-Pb Eutetic Process: 225°C peak Pb-Free Process 245° - 250°C peak	J-STD-020, Table 4-1, 4-2 and 5-2, Figure 5-1
Solderability	10X Magnification	J-STD-002, 95% Coverage
Vibration (High Frequency)	20g peak, 10-2000 Hz, 12 times in each of three perpendicular directions (total 36)	MIL-STD-202, Method 204, Condition D
Mechanical Shock	50g, 11 ms, 1/2-sine, 18 shocks: 3 each direction, each of 3 axes	MIL-STD-202, Method 213, Condition A
Marking Resistance to Solvents	Isopropyl alcohol + mineral spirits at 25°C; terpene defluxer at 25°C; distilled water + proylene glycol monomethyl ether + monoethanolamine at 63°C to 70°C	MIL-STD-202, Method 215