

High Power Bi-Directional Coupler

SYBD-16-172HP+

50Ω 16dB Coupling DC Pass 1400 to 1750 MHz

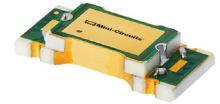

Generic photo used for illustration purposes only

CASE STYLE: JB1233

+RoHS Compliant

The +Suffix identifies RoHS Compliance. See our web site for RoHS Compliance methodologies and qualifications

Maximum Ratings

Operating Temperature	-55°C to 100°C
Storage Temperature	-55°C to 100°C
DC Current	2A

Permanent damage may occur if any of these limits are exceeded.

Pin Connections

INPUT	1
OUTPUT	2
COUPLED (forward)	4
COUPLED (reverse)	3
GROUND	5

Outline Drawing

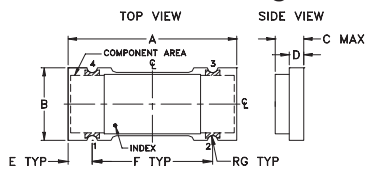

PCB Land Pattern

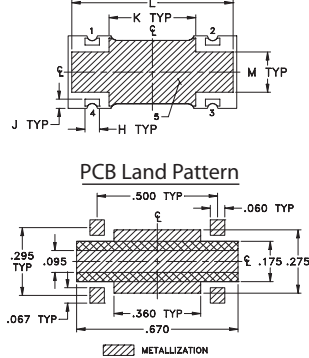

Suggested Layout,
Tolerance to be within ±.002

Outline Dimensions (inch/mm)

A	B	C	D	E	F	G
.70	.32	.13	.060	.100	.500	.022
17.78	8.13	3.30	1.52	2.54	12.70	0.56
H	J	K	L	M		wt
.060	.040	.360	.670	.175		grams
1.52	1.02	9.14	17.02	4.45		0.68

Demo Board MCL P/N: TB-398 Suggested PCB Layout (PL-260)

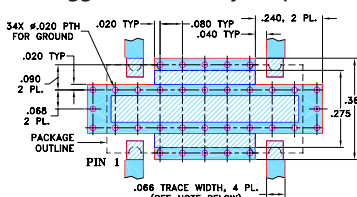

- NOTES: 1. TRACE WIDTH IS SHOWN FOR ROGERS RO4350B WITH DIELECTRIC THICKNESS .030" ± .002"; COPPER: 1/2 OZ. EACH SIDE. FOR OTHER MATERIALS TRACE WIDTH MAY NEED TO BE MODIFIED.
2. BOTTOM SIDE OF THE PCB IS CONTINUOUS GROUND PLANE.
3. DENOTES PCB COPPER LAYOUT WITH SMOBC (SOLDER MASK OVER BARE COPPER)
4. DENOTES COPPER LAND PATTERN FREE OF SOLDER MASK

Notes

- A. Performance and quality attributes and conditions not expressly stated in this specification document are intended to be excluded and do not form a part of this specification document.
B. Electrical specifications and performance data contained in this specification document are based on Mini-Circuit's applicable established test performance criteria and measurement instructions.
C. The parts covered by this specification document are subject to Mini-Circuit's standard limited warranty and terms and conditions (collectively, "Standard Terms"); Purchasers of this part are entitled to the rights and benefits contained therein. For a full statement of the Standard Terms and the exclusive rights and remedies thereunder, please visit Mini-Circuit's website at www.minicircuits.com/MCLStore/terms.jsp

Features

- high power handling, 50 watts max.
- low mainline loss, 0.22 dB typ.
- excellent VSWR, 1.10:1 typ.
- excellent directivity, 23 dB typ.
- wideband frequency, 1400 to 1750 MHz

Applications

- GPS
- instrumentation
- defense communications

Bi-Directional Coupler Electrical Specifications

FREQ. (MHz)	COUPLING (dB)		MAINLINE LOSS ¹ (dB)		DIRECTIVITY (dB)		VSWR (:1)	POWER INPUT (W)
	Nom.	Flatness	Typ.	Max.	Typ.	Min.		
$f_c - f_u$								
1400-1750			0.22	0.5	23	18	1.10	
1400-1580	17.0±0.7	±0.7	0.20	0.45	23	18	1.10	50
1580-1750	16.0±0.7	±0.6	0.22	0.50	23	17	1.10	25

1. Mainline loss includes theoretical power loss at coupled port.

Typical Performance Data

Frequency (MHz)	Mainline Loss (dB)	Coupling (dB)		Directivity (dB)		Return Loss (dB)			
		In-Out	In-Cpl Fwd	Out-Cpl Rev	Out-Cpl Fwd	In-Cpl Rev	In	Out	Cpl Fwd
1400.00	0.19	17.18	17.13	24.96	26.06	29.33	26.82	32.71	33.70
1440.00	0.19	16.96	16.90	24.98	26.04	30.09	27.42	33.65	34.76
1480.00	0.20	16.74	16.69	25.00	25.82	31.14	28.29	35.49	37.02
1520.00	0.20	16.54	16.49	25.14	25.87	32.58	29.43	37.65	40.00
1580.00	0.21	16.24	16.19	25.05	25.94	34.80	31.26	42.49	45.85
1620.00	0.21	16.04	15.99	25.20	25.85	36.75	33.41	44.47	44.86
1660.00	0.22	15.86	15.81	25.10	25.75	37.67	35.64	43.01	42.20
1700.00	0.23	15.69	15.64	24.79	25.51	37.14	38.63	40.47	39.42
1740.00	0.23	15.52	15.47	24.88	25.47	34.91	42.40	36.76	35.45
1750.00	0.24	15.48	15.44	24.90	25.49	34.46	42.66	36.15	34.86

SYBD-16-172HP+
MAINLINE LOSS

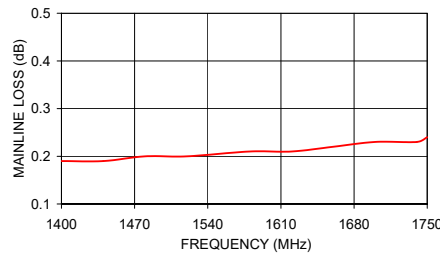

SYBD-16-172HP+
COUPLING & DIRECTIVITY

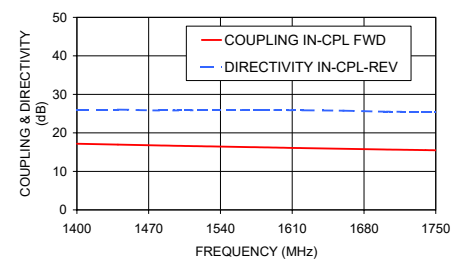

SYBD-16-172HP+
RETURN LOSS

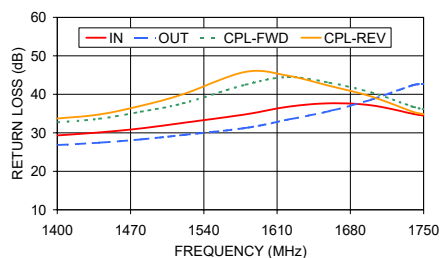

Electrical Schematic

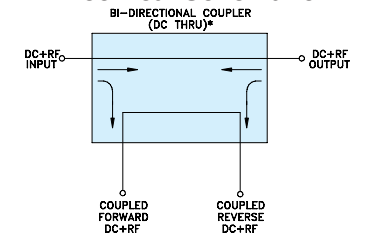

* ELECTRICAL SCHEMATIC IS FOR BI-DIRECTIONAL COUPLER WITHOUT INTERNAL TRANSFORMERS AND RESISTORS.



www.minicircuits.com P.O. Box 350166, Brooklyn, NY 11235-0003 (718) 934-4500 sales@minicircuits.com

REV. B
M151107
ED-12762/3
SYBD-16-172HP+
WZ/CP/AM
200811

Bi-Directional Coupler

SYBD-16-172HP+

Typical Performance Data

TEST CONDITIONS: INPUT POWER =0 dBm @Temperature = +25°C

FREQ. (MHz)	INSERTION LOSS		COUPLING		DIRECTIVITY		RETURN LOSS			
	(dB)		(dB)		(dB)		(dB)			
	IN-OUT	FWD-REV	IN-FWD	OUT-REV	IN-REV	OUT-FWD	IN	OUT	FWD	REV
1000	0.07	0.06	20.00	20.03	32.18	30.45	32.03	32.75	33.99	34.72
1100	0.09	0.08	19.23	19.26	30.55	29.31	31.49	31.70	33.40	33.96
1200	0.12	0.11	18.53	18.56	30.05	28.22	31.66	31.20	33.28	33.61
1300	0.13	0.12	17.95	17.99	28.34	26.71	32.90	32.18	33.90	33.91
1400	0.15	0.15	17.32	17.36	28.79	26.84	34.69	33.63	34.54	34.07
1450	0.15	0.14	17.04	17.08	28.31	26.21	36.11	34.70	35.87	34.85
1500	0.15	0.15	16.85	16.90	26.79	25.24	39.23	37.80	37.34	35.29
1550	0.16	0.16	16.55	16.60	27.73	26.10	41.04	39.99	38.43	35.54
1580	0.18	0.19	16.47	16.51	26.09	24.17	43.55	44.51	40.87	37.48
1600	0.17	0.16	16.40	16.45	25.59	23.79	42.72	50.89	42.53	37.11
1700	0.19	0.19	15.88	15.92	27.15	25.11	36.95	44.51	51.25	37.42
1750	0.19	0.18	15.66	15.71	27.10	25.12	34.11	38.49	57.77	37.40
1800	0.21	0.21	15.45	15.49	27.74	25.34	32.34	35.10	48.52	37.34
1850	0.23	0.23	15.22	15.27	28.70	26.34	31.04	33.18	42.71	37.70
1900	0.24	0.25	15.09	15.14	27.86	25.17	29.36	31.05	37.84	36.68
1950	0.24	0.24	14.98	15.00	26.04	24.27	27.90	29.03	35.50	34.43
2000	0.26	0.27	14.75	14.79	28.35	25.27	27.31	28.23	34.34	34.35
2100	0.30	0.28	14.41	14.43	30.09	26.91	26.24	26.52	32.13	32.54
2200	0.31	0.33	14.21	14.28	27.60	24.89	24.93	24.95	30.07	30.72
2300	0.33	0.32	13.99	14.03	26.85	24.20	24.45	24.20	28.78	29.48
2400	0.36	0.35	13.66	13.72	28.56	25.54	24.86	24.47	28.56	29.07
2500	0.37	0.37	13.44	13.49	29.51	26.73	25.41	24.78	28.57	28.68
2600	0.41	0.39	13.22	13.25	31.39	28.86	25.96	26.20	29.12	28.79
2700	0.44	0.43	12.98	13.02	37.97	33.19	27.40	27.08	30.55	29.81
2800	0.43	0.44	12.84	12.93	31.41	29.99	29.09	29.05	30.64	29.82
2900	0.46	0.45	12.63	12.71	34.29	34.60	30.64	31.14	33.09	31.56
3000	0.47	0.48	12.40	12.49	37.54	38.72	33.77	36.25	36.79	34.59
3100	0.49	0.48	12.23	12.32	38.04	54.75	35.27	38.47	41.70	37.90
3200	0.51	0.51	12.05	12.13	35.17	40.32	34.08	35.59	50.15	45.43
3300	0.53	0.53	11.92	11.97	31.68	32.30	32.46	33.17	52.11	46.18
3400	0.55	0.55	11.80	11.89	27.96	30.24	32.57	31.64	43.89	40.18
3500	0.57	0.58	11.68	11.70	26.53	27.98	32.35	31.32	41.12	39.38
3600	0.60	0.60	11.55	11.58	25.57	26.78	33.74	32.76	43.62	38.40
3700	0.60	0.62	11.39	11.41	24.81	25.03	37.31	34.31	45.34	37.44
3800	0.63	0.63	11.29	11.36	23.58	23.41	40.13	37.54	44.52	37.85
3900	0.64	0.65	11.15	11.22	22.89	22.86	40.29	40.80	36.72	35.58
4000	0.67	0.67	11.09	11.14	21.92	21.54	35.37	38.28	32.50	32.94
4500	0.82	0.85	10.77	10.85	18.73	18.89	23.72	24.10	20.85	20.95
4750	0.85	0.90	10.74	10.90	18.32	18.47	22.47	22.93	18.77	19.17
5000	0.90	0.95	10.68	10.82	17.96	18.19	21.77	22.59	17.77	17.93
5250	0.92	0.98	10.69	10.80	17.57	19.55	21.71	22.83	17.49	17.95
5500	0.97	1.05	10.59	10.77	17.99	19.11	22.12	22.80	17.63	18.43
5750	1.01	1.06	10.58	10.74	17.93	18.89	22.71	23.19	18.20	18.34
6000	1.05	1.13	10.44	10.72	18.10	18.76	23.40	23.61	17.65	17.77
6250	1.13	1.23	10.42	10.70	16.91	17.34	23.91	23.96	16.68	16.88
6500	1.27	1.40	10.26	10.80	15.44	16.18	23.09	23.39	15.35	16.11
6750	1.34	1.61	10.28	10.62	14.34	14.43	20.75	21.97	13.98	14.55
7000	1.65	1.85	10.39	10.84	12.81	13.34	17.61	19.99	12.60	13.74
7250	1.85	2.06	10.45	11.07	10.56	11.29	14.40	17.04	12.08	13.03
7500	2.08	2.23	10.49	11.67	8.94	9.67	12.78	14.68	11.73	13.22
7750	2.36	2.44	10.81	11.61	9.19	9.33	12.80	15.10	12.88	14.33
8000	2.31	2.27	11.92	11.71	8.97	7.39	15.80	16.86	18.78	17.38
8500	2.80	3.54	15.76	12.62	14.15	16.39	10.40	14.22	8.19	11.07

REV. X1

SYBD-16-172HP+

090125

Page 1 of 3



IF/RF MICROWAVE COMPONENTS • ISO 9001 ISO 14001 AS 9100 CERTIFIED • RoHS compliant

P.O. Box 350166, Brooklyn, New York 11235-0003 (718) 934-4500 Fax (718) 332-4661



The Design Engineers Search Engine finds the model you need, Instantly • For detailed performance specs & shopping online see



Bi-Directional Coupler

SYBD-16-172HP+

Typical Performance Data

TEST CONDITIONS: INPUT POWER =0 dBm @Temperature = -55°C

FREQ. (MHz)	INSERTION LOSS (dB)		COUPLING (dB)		DIRECTIVITY (dB)		RETURN LOSS (dB)			
	IN-OUT	FWD-REV	IN-FWD	OUT-REV	IN-REV	OUT-FWD	IN	OUT	FWD	REV
1000	0.01	0.06	19.96	19.99	33.28	31.19	32.62	33.37	34.40	35.29
1100	0.04	0.06	19.18	19.20	30.93	29.49	31.32	31.51	32.87	33.55
1200	0.05	0.04	18.48	18.50	30.32	28.22	31.11	30.72	32.16	32.64
1300	0.07	0.03	17.90	17.93	27.95	26.54	32.70	31.97	31.38	31.70
1400	0.08	0.02	17.25	17.28	28.41	26.52	34.37	33.30	32.63	32.46
1450	0.09	0.02	17.00	17.01	27.67	25.58	35.21	33.77	34.59	33.94
1500	0.08	0.02	16.79	16.83	26.53	24.83	37.10	35.75	35.66	34.17
1550	0.08	0.01	16.48	16.52	27.12	25.82	38.45	36.55	36.99	34.92
1580	0.11	0.02	16.42	16.44	25.01	23.67	41.67	39.07	39.78	37.27
1600	0.10	0.00	16.34	16.37	24.96	23.35	44.35	41.52	41.42	36.17
1700	0.11	0.00	15.80	15.83	26.21	24.75	41.06	42.04	46.39	35.68
1750	0.12	0.00	15.58	15.62	25.79	24.94	36.20	38.57	55.32	37.28
1800	0.13	0.02	15.36	15.39	26.47	25.15	33.26	35.00	46.65	38.19
1850	0.15	0.04	15.12	15.16	27.50	26.40	31.21	33.03	41.90	38.19
1900	0.16	0.06	15.00	15.03	26.70	24.87	29.01	30.49	37.80	35.98
1950	0.16	0.04	14.88	14.91	25.24	23.66	27.46	28.53	35.04	34.52
2000	0.17	0.06	14.65	14.68	26.67	24.88	26.89	27.86	32.21	34.10
2100	0.22	0.08	14.30	14.31	28.54	26.90	25.99	26.34	29.62	31.34
2200	0.22	0.10	14.09	14.15	27.43	24.89	24.57	24.70	28.53	29.38
2300	0.25	0.09	13.89	13.91	26.86	23.81	24.09	24.00	27.23	27.70
2400	0.26	0.13	13.55	13.59	29.76	25.12	24.36	24.17	28.29	28.52
2500	0.27	0.12	13.31	13.33	30.12	26.25	24.86	24.59	28.10	28.34
2600	0.31	0.14	13.08	13.08	32.87	29.53	25.83	25.74	27.75	27.29
2700	0.32	0.17	12.83	12.86	41.01	36.50	27.09	26.49	34.78	33.35
2800	0.31	0.17	12.72	12.75	31.21	30.93	28.35	27.77	31.04	30.50
2900	0.35	0.17	12.48	12.54	34.12	35.31	30.49	31.20	34.45	32.51
3000	0.35	0.20	12.24	12.30	35.18	41.48	34.78	37.03	34.50	32.45
3100	0.38	0.20	12.06	12.11	36.03	41.29	34.47	37.01	35.04	33.32
3200	0.38	0.22	11.87	11.94	35.24	41.64	33.19	35.21	35.81	35.59
3300	0.41	0.24	11.72	11.77	32.18	34.41	31.73	33.91	36.06	38.70
3400	0.41	0.24	11.62	11.69	26.98	30.84	31.80	31.79	42.67	43.86
3500	0.43	0.26	11.47	11.49	26.41	27.43	32.72	32.26	37.88	37.90
3600	0.46	0.27	11.35	11.35	24.40	27.51	35.00	34.25	37.23	46.07
3700	0.46	0.29	11.20	11.20	24.31	25.52	37.31	36.48	35.37	38.79
3800	0.48	0.29	11.08	11.12	24.25	24.25	38.22	39.45	35.51	38.59
3900	0.49	0.31	10.94	10.99	24.08	23.93	40.35	44.69	34.88	35.07
4000	0.53	0.31	10.87	10.90	23.23	22.56	35.63	39.95	34.86	35.29
4500	0.64	0.46	10.52	10.62	18.39	19.07	24.24	24.78	21.21	21.70
4750	0.65	0.48	10.45	10.56	18.80	18.79	22.64	22.82	19.09	19.56
5000	0.72	0.52	10.36	10.47	18.03	18.14	21.21	21.78	17.30	17.50
5250	0.72	0.55	10.38	10.47	17.42	18.63	21.15	22.00	16.24	16.44
5500	0.76	0.60	10.30	10.45	17.78	18.16	21.61	22.35	16.20	16.81
5750	0.78	0.60	10.30	10.42	17.69	18.28	23.49	23.92	17.09	17.29
6000	0.82	0.62	10.08	10.34	18.46	18.84	23.79	23.95	17.78	18.05
6250	0.87	0.67	10.08	10.24	17.03	18.69	24.52	23.83	17.27	17.64
6500	0.98	0.81	9.99	10.32	15.67	16.71	23.00	22.85	15.50	16.27
6750	1.06	1.07	9.93	10.26	14.18	14.07	19.70	21.08	13.23	13.65
7000	1.24	1.23	10.01	10.36	13.56	13.09	17.10	18.92	11.75	12.13
7250	1.50	1.52	10.03	10.56	11.17	11.45	14.27	16.33	10.58	10.78
7500	1.65	1.55	10.06	10.79	10.26	10.13	12.95	14.82	10.91	11.90
7750	1.96	1.65	10.15	10.63	11.52	10.18	12.77	14.67	13.06	14.37
8000	2.01	1.55	11.04	10.83	10.60	9.68	14.63	15.76	16.90	17.23
8500	2.70	2.95	17.17	10.76	12.63	9.25	11.26	17.70	7.64	13.89

REV. X1

SYBD-16-172HP+

090125

Page 2 of 3



IF/RF MICROWAVE COMPONENTS • ISO 9001 ISO 14001 AS 9100 CERTIFIED • RoHS compliant

P.O. Box 350166, Brooklyn, New York 11235-0003 (718) 934-4500 Fax (718) 332-4661



The Design Engineers Search Engine finds the model you need, Instantly • For detailed performance specs & shopping online see



Bi-Directional Coupler

SYBD-16-172HP+

Typical Performance Data

TEST CONDITIONS: INPUT POWER =0 dBm @Temperature = +100°C

FREQ. (MHz)	INSERTION LOSS (dB)		COUPLING (dB)		DIRECTIVITY (dB)		RETURN LOSS (dB)			
	IN-OUT	FWD-REV	IN-FWD	OUT-REV	IN-REV	OUT-FWD	IN	OUT	FWD	REV
1000	0.09	0.12	20.02	20.06	32.90	30.50	32.63	33.34	35.63	36.52
1100	0.11	0.15	19.25	19.29	31.60	29.62	32.56	32.70	35.71	36.41
1200	0.14	0.17	18.57	18.59	31.33	28.73	33.18	32.57	36.23	36.58
1300	0.16	0.20	17.98	18.03	29.67	27.31	34.77	33.86	37.24	36.88
1400	0.18	0.22	17.35	17.40	30.29	27.63	37.00	35.65	37.67	36.46
1450	0.18	0.22	17.07	17.11	29.64	26.91	38.53	36.90	39.37	37.36
1500	0.18	0.23	16.89	16.94	28.20	25.91	41.80	41.87	41.57	37.38
1550	0.19	0.24	16.59	16.65	29.25	26.91	42.72	45.75	42.58	37.09
1580	0.21	0.27	16.48	16.53	28.50	25.54	43.06	48.43	43.11	38.56
1600	0.20	0.26	16.45	16.50	27.15	24.22	40.73	51.61	45.50	38.05
1700	0.22	0.27	15.93	15.98	28.98	25.92	35.22	40.92	53.63	37.32
1750	0.23	0.28	15.73	15.78	28.93	25.91	33.44	37.25	54.01	37.18
1800	0.25	0.30	15.50	15.55	29.96	26.33	32.07	34.58	48.09	37.22
1850	0.27	0.33	15.30	15.36	30.39	26.68	31.04	33.00	43.73	37.98
1900	0.28	0.35	15.16	15.21	29.36	25.72	29.87	31.46	40.67	38.06
1950	0.28	0.35	15.05	15.08	27.55	24.80	28.63	29.67	38.33	36.15
2000	0.30	0.37	14.80	14.85	30.01	26.08	28.20	29.05	37.23	36.21
2100	0.35	0.39	14.48	14.52	31.66	27.36	27.19	27.26	35.78	35.20
2200	0.36	0.43	14.28	14.35	28.56	25.15	26.13	25.97	33.70	34.08
2300	0.39	0.44	14.07	14.10	27.03	24.44	25.89	25.55	32.01	32.51
2400	0.41	0.48	13.74	13.78	27.84	25.54	26.35	25.81	31.98	31.99
2500	0.43	0.50	13.52	13.59	29.16	27.35	26.60	26.39	30.97	30.92
2600	0.47	0.53	13.32	13.34	28.93	28.23	26.94	27.74	31.37	30.59
2700	0.50	0.56	13.04	13.09	32.80	32.02	28.41	28.59	31.59	30.38
2800	0.50	0.58	12.98	13.09	28.44	28.62	29.87	30.40	30.91	29.80
2900	0.53	0.61	12.74	12.83	30.65	32.68	30.56	32.19	33.10	31.40
3000	0.54	0.64	12.50	12.59	32.56	34.75	32.93	34.42	35.59	33.70
3100	0.57	0.66	12.36	12.43	32.93	44.92	34.39	35.11	37.83	36.18
3200	0.59	0.69	12.16	12.26	34.07	47.25	35.45	33.93	41.21	41.50
3300	0.62	0.72	12.04	12.10	32.81	34.96	34.42	32.90	40.52	41.03
3400	0.63	0.73	11.94	12.01	29.15	31.92	35.64	32.14	45.00	38.27
3500	0.66	0.76	11.82	11.84	27.78	29.44	36.12	32.34	48.73	37.69
3600	0.69	0.79	11.68	11.72	27.71	27.52	38.26	33.64	49.82	33.25
3700	0.71	0.81	11.54	11.61	26.78	25.56	43.37	34.96	68.76	32.36
3800	0.72	0.83	11.45	11.53	24.97	24.11	42.60	37.59	46.91	33.36
3900	0.75	0.87	11.31	11.40	24.15	23.42	38.62	38.95	37.54	33.41
4000	0.78	0.88	11.24	11.31	22.72	22.04	33.39	34.81	32.21	32.21
4500	0.91	1.08	10.95	11.06	19.29	19.01	25.41	25.62	22.53	21.94
4750	0.97	1.14	10.94	11.10	17.91	18.44	23.67	24.81	19.53	19.54
5000	1.05	1.22	10.89	11.01	17.33	18.18	22.54	24.37	18.39	18.70
5250	1.09	1.29	10.98	11.12	16.48	18.85	22.09	23.51	18.06	18.83
5500	1.15	1.36	10.82	11.20	16.54	17.95	21.77	22.35	17.77	18.72
5750	1.20	1.41	10.84	11.17	16.18	17.58	21.48	21.46	17.92	18.14
6000	1.26	1.50	10.71	11.20	16.49	17.43	22.31	22.46	17.12	17.47
6250	1.37	1.61	10.60	11.19	16.08	16.32	23.52	23.89	16.34	16.66
6500	1.54	1.86	10.50	11.32	14.28	14.16	23.32	23.88	15.60	16.19
6750	1.70	2.04	10.45	11.55	11.60	13.38	21.15	24.63	14.58	16.08
7000	2.00	2.42	10.39	11.79	9.13	11.23	18.14	25.69	13.38	15.76
7250	2.35	2.69	10.79	12.62	6.58	9.00	14.42	19.90	12.89	15.55
7500	2.54	2.84	11.52	13.72	4.80	7.25	12.36	15.99	12.34	14.89
7750	2.59	2.84	11.94	13.72	5.88	7.42	13.36	15.30	13.27	15.21
8000	2.32	2.49	12.71	13.42	7.45	7.68	16.39	17.27	18.75	17.56
8500	3.19	3.98	12.84	15.45	16.56	23.04	11.88	10.96	10.35	8.38

REV. X1

SYBD-16-172HP+

090125

Page 3 of 3



IF/RF MICROWAVE COMPONENTS • ISO 9001 ISO 14001 AS 9100 CERTIFIED • RoHS compliant

P.O. Box 350166, Brooklyn, New York 11235-0003 (718) 934-4500 Fax (718) 332-4661



The Design Engineers Search Engine finds the model you need, Instantly • For detailed performance specs & shopping online see



Bi-Directional Coupler

Typical Performance Curves

SYBD-16-172HP+

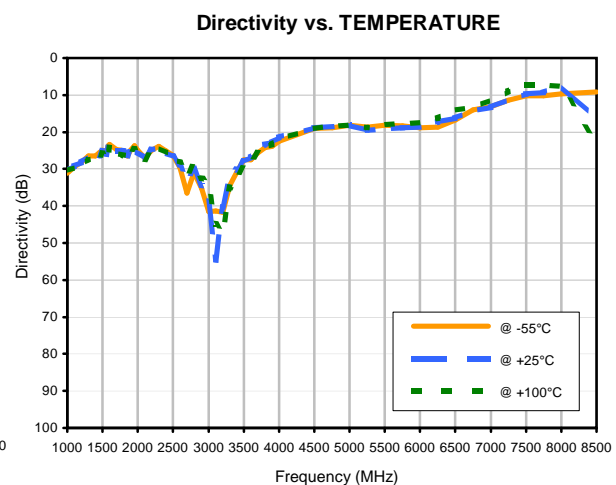
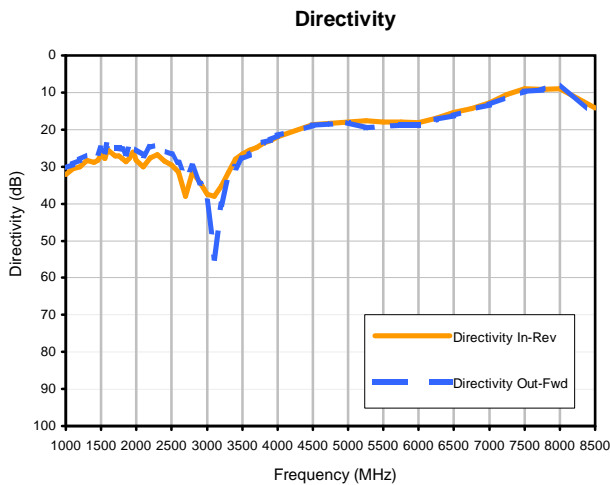
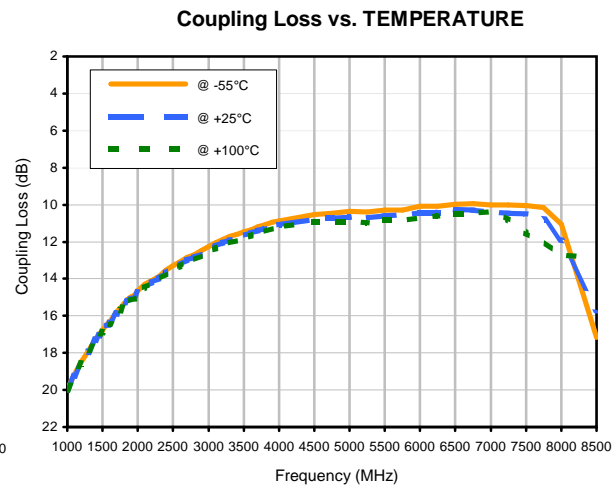
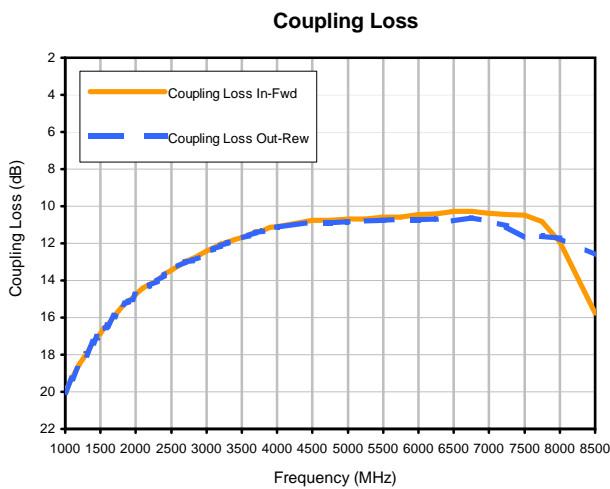
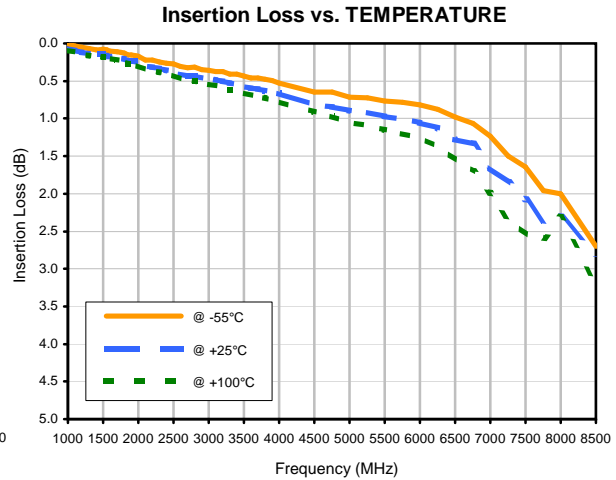

REV. X1
SYBD-16-172HP+
090125
Page 1 of 2



IF/RF MICROWAVE COMPONENTS • ISO 9001 ISO 14001 AS 9100 CERTIFIED • RoHS compliant
P.O. Box 350166, Brooklyn, New York 11235-0003 (718) 934-4500 Fax (718) 332-4661



The Design Engineers Search Engine finds the model you need, Instantly • For detailed performance specs & shopping online see



Bi-Directional Coupler

Typical Performance Curves

SYBD-16-172HP+

Return Loss

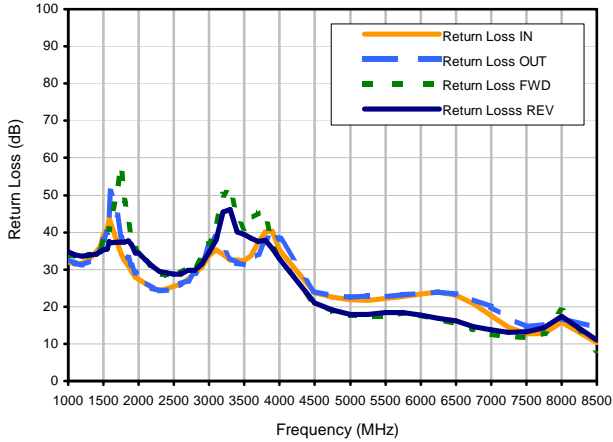

Return Loss In vs. TEMPERATURE

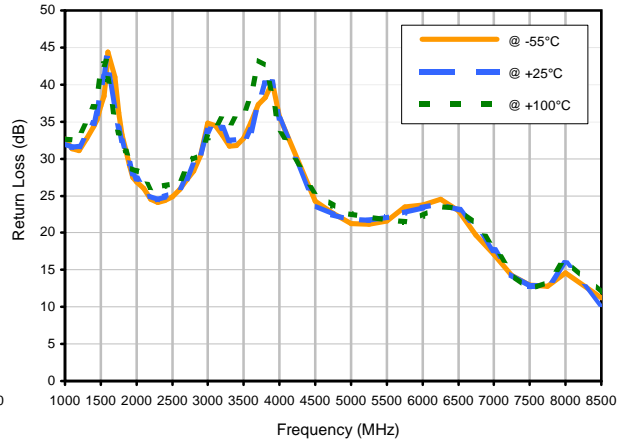

Return Loss Out vs. TEMPERATURE

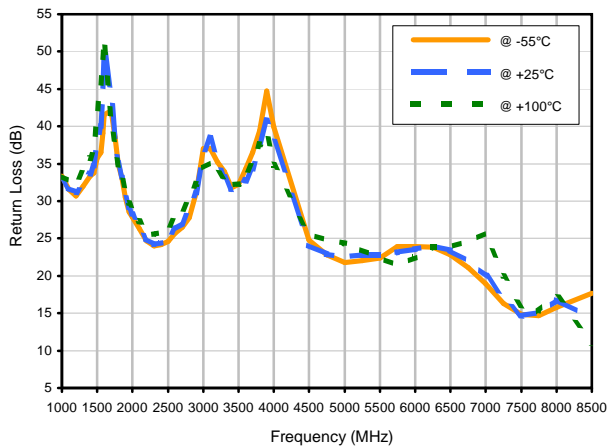

Return Loss Fwd vs. TEMPERATURE

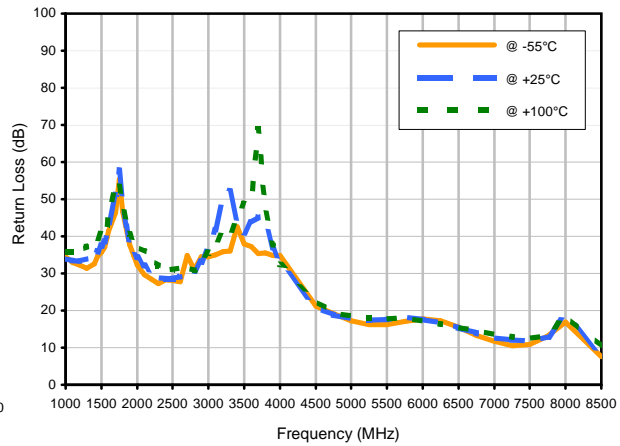

Return Loss Rev vs. TEMPERATURE

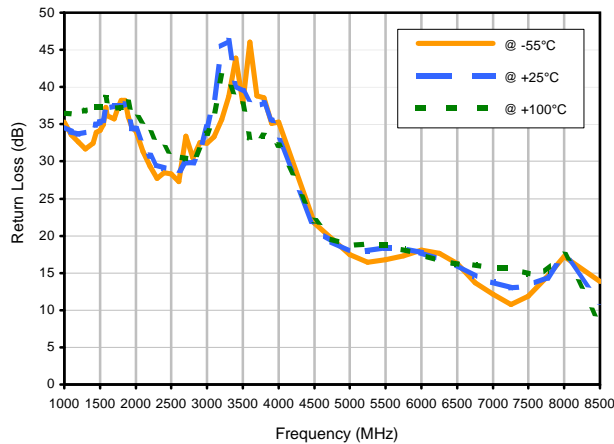

REV. X1
SYBD-16-172HP+
090125
Page 2 of 2



IF/RF MICROWAVE COMPONENTS • ISO 9001 ISO 14001 AS 9100 CERTIFIED RoHS compliant
P.O. Box 350166, Brooklyn, New York 11235-0003 (718) 934-4500 Fax (718) 332-4661



The Design Engineers Search Engine finds the model you need, Instantly • For detailed performance specs & shopping online see



Outline Dimensions

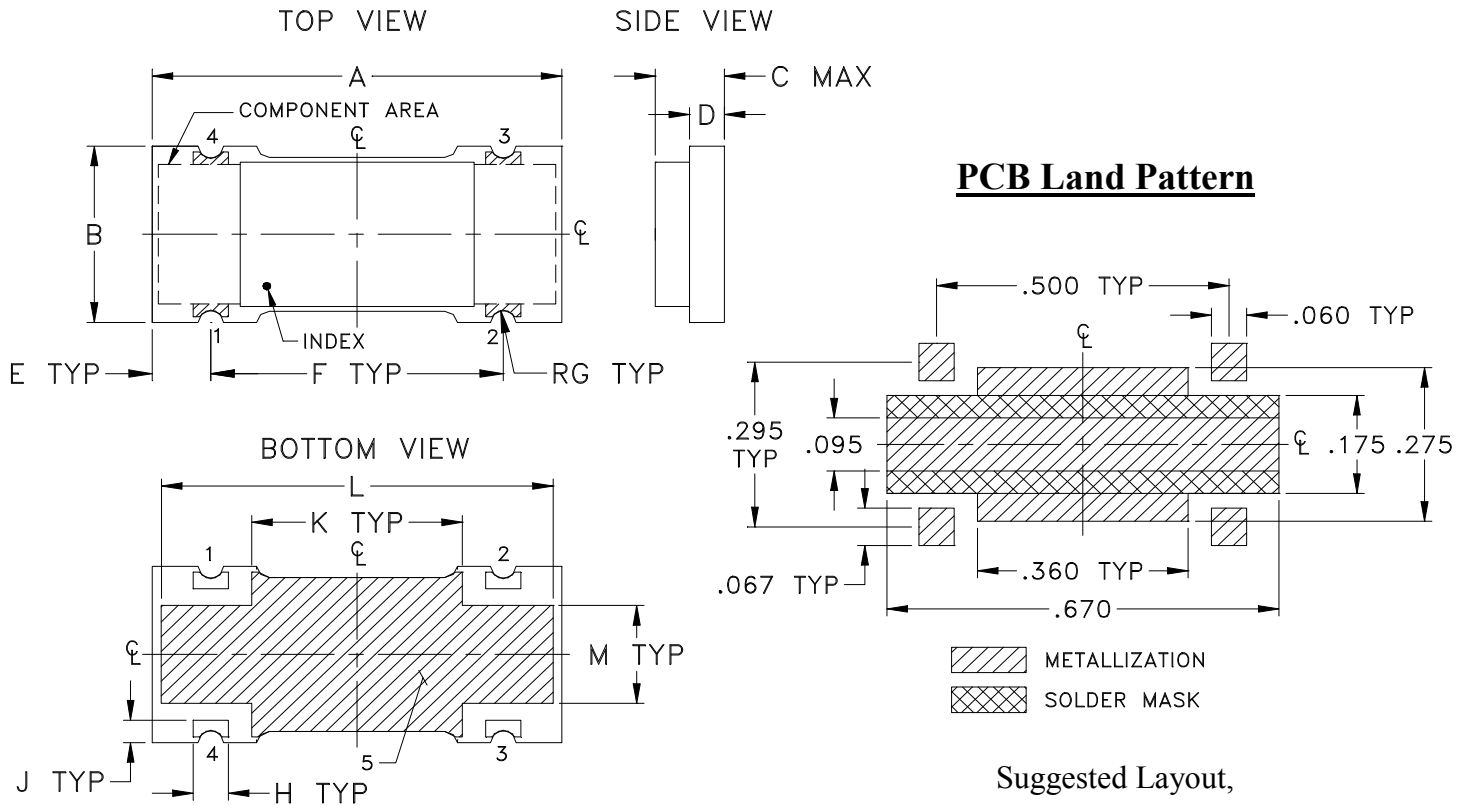

Suggested Layout,
Tolerance to be within $\pm .002$

CASE #.	A	B	C	D	E	F	G	H	J	K	L	M	WT, GRAM
JB1233	.70 (17.78)	.32 (8.13)	.13 (3.30)	.060 (1.52)	.100 (2.54)	.500 (12.70)	.022 (0.56)	.060 (1.52)	.040 (1.02)	.360 (9.14)	.670 (17.02)	.175 (4.45)	0.68

Dimensions are in inches (mm). Tolerances: 2 Pl. $\pm .01$; 3 Pl. $\pm .005$

Notes:

- Open style, Base material: Printed wiring laminate.
- Termination finish: 3-5 μ inch (.08-.13 microns) Gold over 120-240 μ inch (3.05-6.10 microns) Nickel plate.
All models, (+) suffix.

Tape & Reel Packaging TR-F84

DEVICE ORIENTATION IN T&R

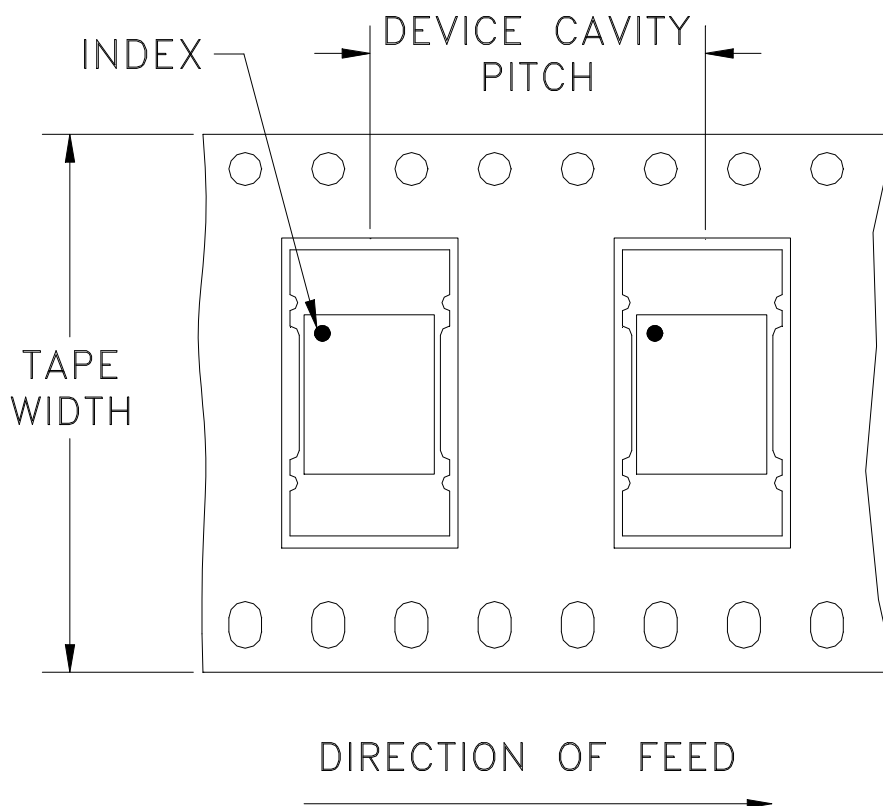

Tape Width, mm	Device Cavity Pitch, mm	Reel Size, inches	Devices per Reel
32	12	13	500

Mini-Circuits carrier tape materials provide protection from ESD (Electro-Static Discharge) during handling and transportation. Tapes are static dissipative and comply with industry standards EIA-481/EIA-541.

Go to: www.minicircuits.com/pages/pdfs/tape.pdf



INTERNET <http://www.minicircuits.com>

P.O. Box 350166, Brooklyn, New York 11235-0003 (718) 934-4500 Fax (718) 332-4661

Distribution Centers NORTH AMERICA 800-654-7949 • 417-335-5935 • Fax 417-335-5945 • EUROPE 44-1252-832600 • Fax 44-1252-837010

Mini-Circuits ISO 9001 & ISO 14001 Certified

THIRD ANGLE PROJECTION

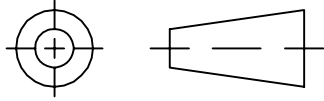

REVISIONS

REV	ECN No.	DESCRIPTION	DATE	DR	AUTH
OR	M109017	NEW RELEASE	12/29/06	MMG	WP

SUGGESTED MOUNTING CONFIGURATION FOR
JB1233 CASE STYLE, "rw" PIN CONNECTION

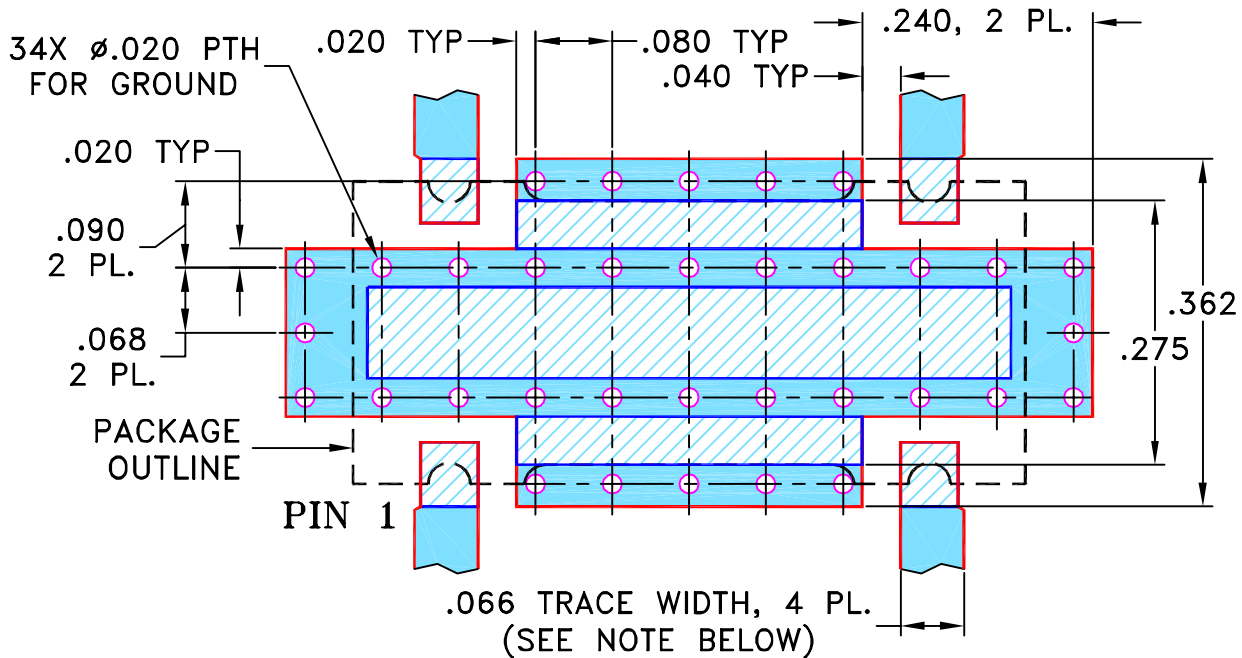

- NOTES: 1. TRACE WIDTH IS SHOWN FOR ROGERS R04350B WITH DIELECTRIC THICKNESS .030" ± .002"; COPPER: 1/2 OZ. EACH SIDE. FOR OTHER MATERIALS TRACE WIDTH MAY NEED TO BE MODIFIED.
2. BOTTOM SIDE OF THE PCB IS CONTINUOUS GROUND PLANE.

- DENOTES PCB COPPER LAYOUT WITH SMOBC (SOLDER MASK OVER BARE COPPER)
- DENOTES COPPER LAND PATTERN FREE OF SOLDER MASK

UNLESS OTHERWISE SPECIFIED	INITIALS		DATE
	DRAWN	MMG	12/21/06
	CHECKED	AV	12/29/06
	APPROVED	WP	12/29/06

DIMENSIONS ARE IN INCHES
TOLERANCES ON:
2 PL DECIMALS ±
3 PL DECIMALS ± .005
ANGLES ±
FRACTIONS ±

Mini-Circuits® 13 Neptune Avenue
Brooklyn NY 11235

PL, rw, JB1233, SYBD, TB-398

Mini-Circuits®
THIS DOCUMENT AND ITS CONTENTS ARE THE PROPERTY OF MINI-CIRCUITS. EXCEPT FOR USE EXPRESSLY GRANTED, IN WRITING, TO ITS VENDORS, VENDEE AND THE UNITED STATES GOVERNMENT, MINI-CIRCUITS RESERVES ALL PROPRIETARY DESIGN, USE, MANUFACTURING AND REPRODUCTION RIGHTS THERETO. THESE CONTENTS SHALL NOT BE USED, DUPLICATED OR DISCLOSED TO ANY OUTSIDE PARTY, IN WHOLE OR IN PART, WITHOUT WRITTEN PERMISSION OF MINI-CIRCUITS.

SIZE A	CODE IDENT 15542	DRAWING NO: 98-PL-260	REV: OR
FILE: 98PL260	SCALE: 5:1	SHEET: 1 OF 1	

Evaluation Board and Circuit

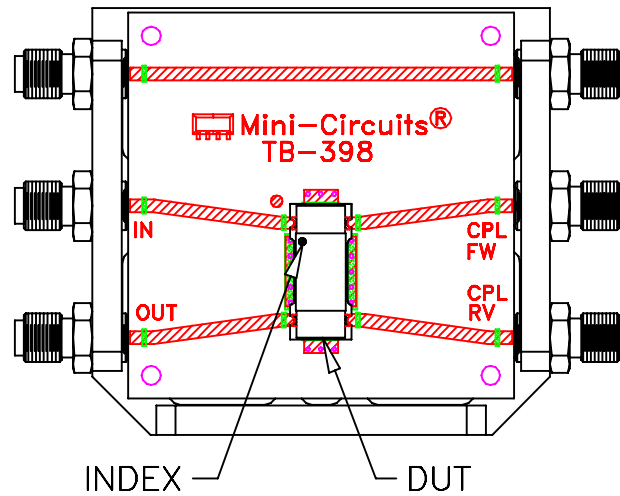

TB-398

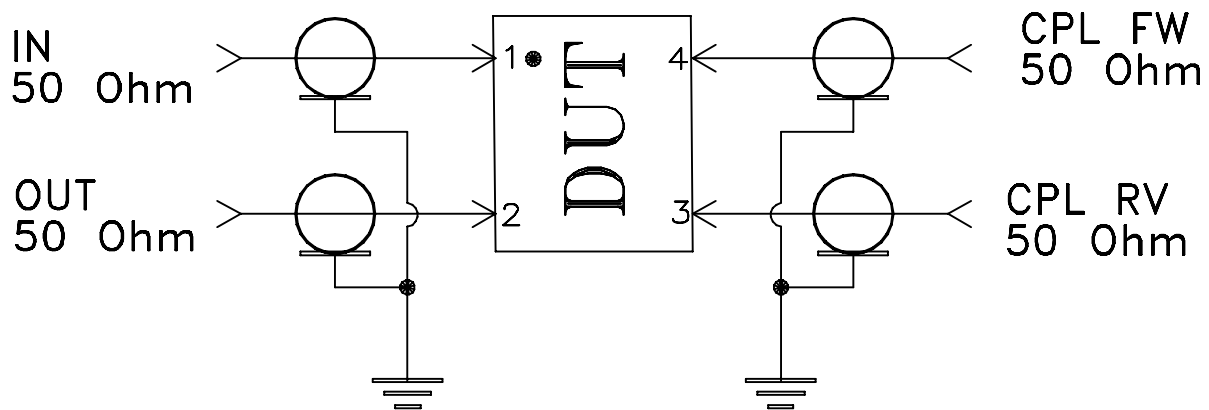

Schematic Diagram

Notes:

1. SMA Female connectors.
2. PCB Material: Rogers R04350 or equivalent, Dielectric Constant=3.5, Thickness=.030 inch.

 **Mini-Circuits®**

All Mini-Circuits products are manufactured under exacting quality assurance and control standards, and are capable of meeting published specifications after being subjected to any or all of the following physical and environmental test.

Specification	Test/Inspection Condition	Reference/Spec
Operating Temperature	-55° to 100°C Ambient Environment	Individual Model Data Sheet
Storage Temperature	-55° to 100° C Ambient Environment	Individual Model Data Sheet
Humidity	90 to 95% RH, 240 hours, 50°C	MIL-STD-202, Method 103, Condition A, Except 50°C and end-point electrical test done within 12 hours
Thermal Shock	-55° to 100°C, 100 cycles	MIL-STD-202, Method 107, Condition A-3, except +100°C
Solder Reflow Heat	Sn-Pb Eutetic Process: 225°C peak Pb-Free Process 245° - 250°C peak	J-STD-020, Table 4-1, 4-2 and 5-2, Figure 5-1
Solderability	10X Magnification	J-STD-002, 95% Coverage
Vibration (High Frequency)	20g peak, 10-2000 Hz, 12 times in each of three perpendicular directions (total 36)	MIL-STD-202, Method 204, Condition D
Mechanical Shock	50g, 11 ms, 1/2-sine, 18 shocks: 3 each direction, each of 3 axes	MIL-STD-202, Method 213, Condition A
Marking Resistance to Solvents	Isopropyl alcohol + mineral spirits at 25°C; terpene defluxer at 25°C; distilled water + proylene glycol monomethyl ether + monoethanolamine at 63°C to 70°C	MIL-STD-202, Method 215