

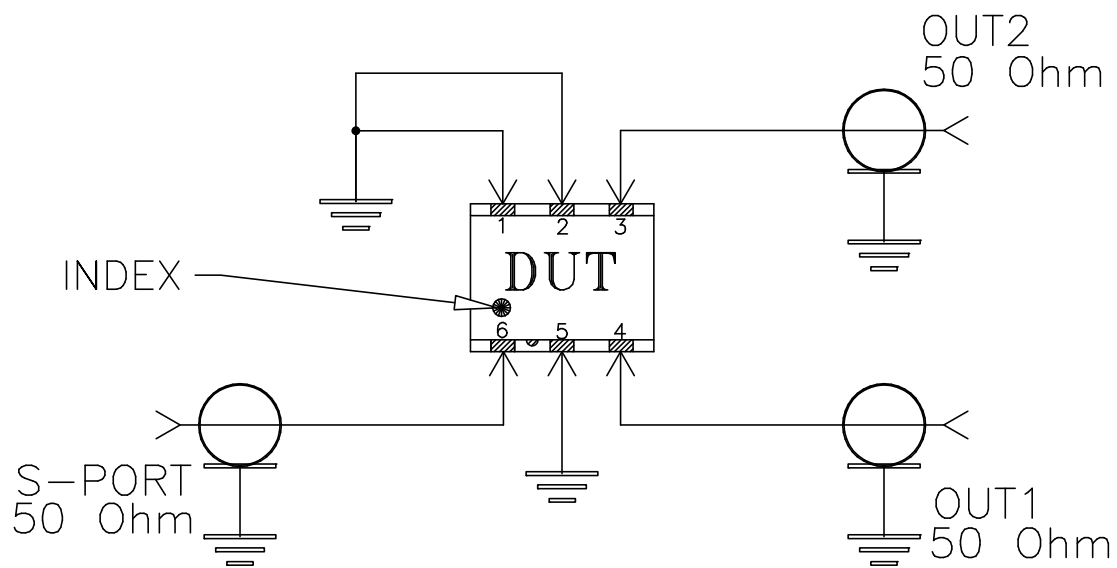

# Evaluation Board and Circuit

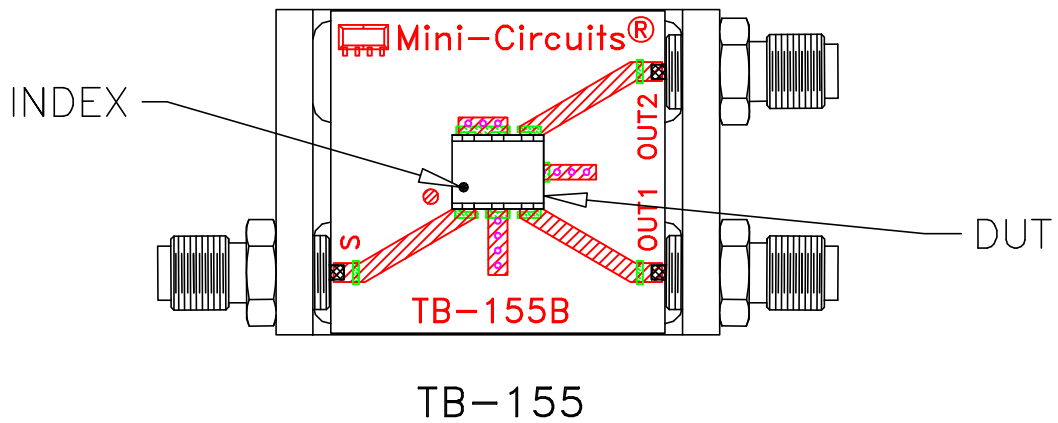

Schematic Diagram

## Notes:

1. SMA Female connectors.
2. PCB Material: Rogers R04350 or equivalent,  
Dielectric Constant=3.5, Thickness=.030 inch.

 Mini-Circuits®