

# Evaluation Board and Circuit

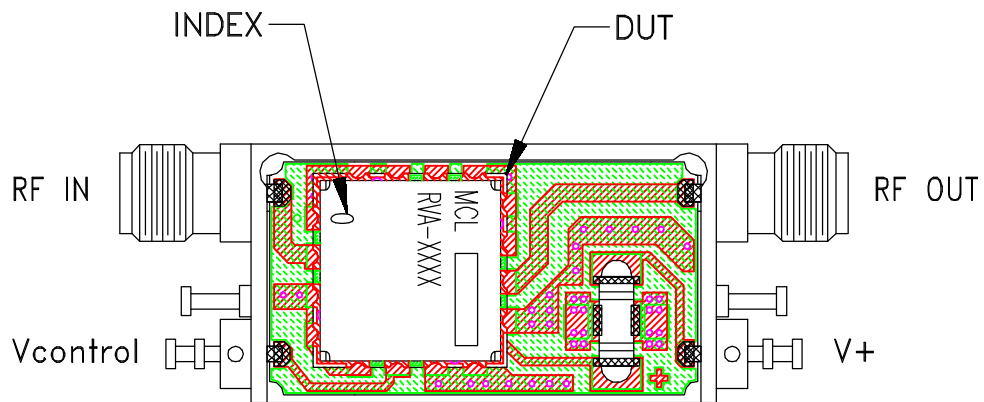

TB-163

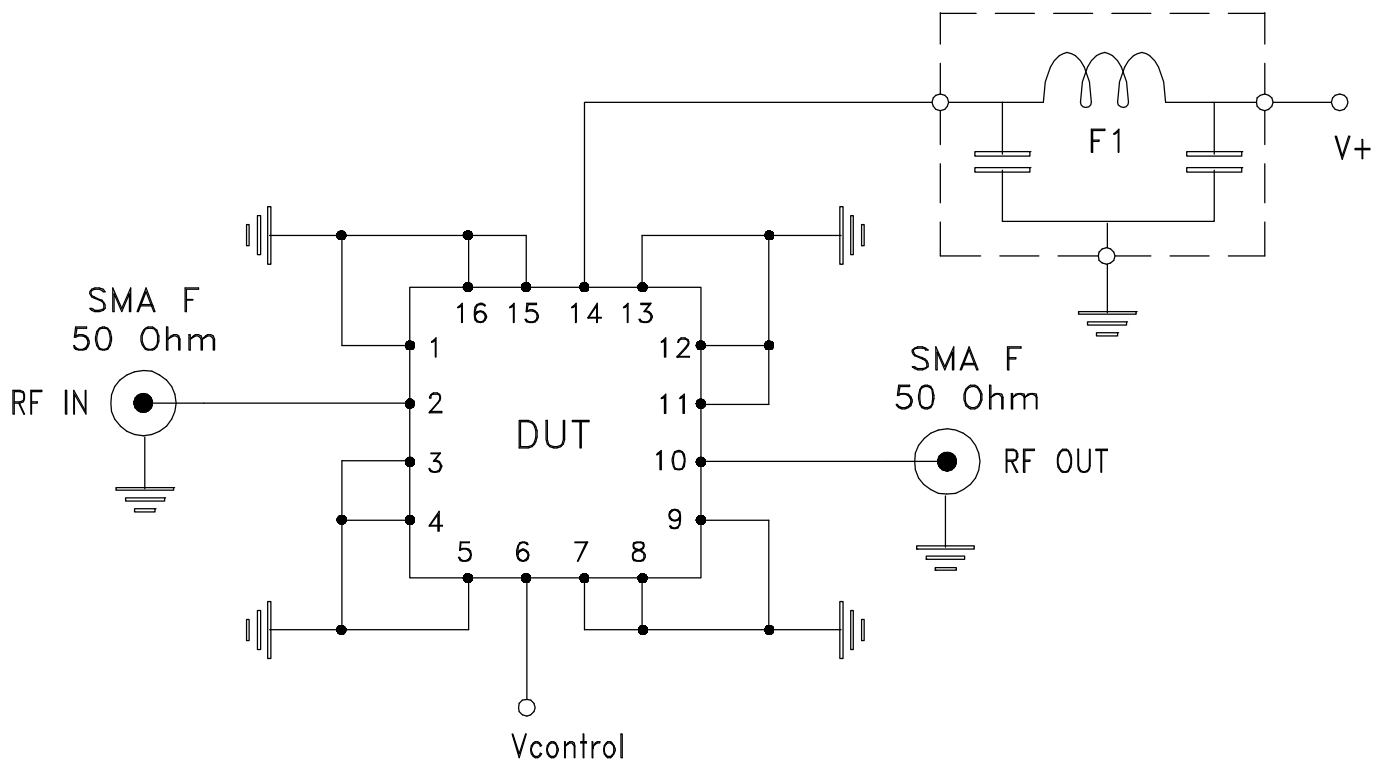

Schematic Diagram

## Notes:

1. SMA Female connectors.
2. PCB Material: ROGERS R04350B or equivalent, Dielectric Constant=4.5, Thickness=.020 inch.

 **Mini-Circuits®**