

Engineering Development Model

RF Transformer

TC1-ED7194/1

Impedance Ratio : 1

Important Note

This model has been designed, built and tested in our engineering department. Performance data represents model capability. At present it is a non-catalog model. On request, we can supply a final specification sheet, part number and price/delivery information.



Please click "Back", and then click "Contact Us" for Applications support.

CASE STYLE : AT224

ELECTRICAL SPECIFICATIONS 50Ω @ +25°C					
Parameter		Min.	Typ.	Max.	Units
Frequency		1300		3700	MHz
Insertion Loss *	3 dB Bandwidth		1300 - 3700		MHz
	2 dB Bandwidth		1300 - 3700		MHz
	1 dB Bandwidth		1300 - 1900		MHz

Note:

* Insertion Loss is referenced to mid-band loss, 0.33dB typ.

MAXIMUM RATINGS	
Operating Temperature	-40°C to 85°C
Storage Temperature	-55°C to 100°C
RF Power	0.25 W
DC Current	30 mA

Configuration : G

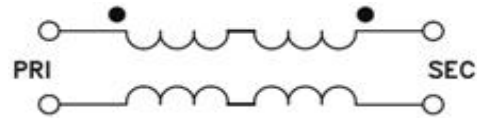

PIN CONNECTIONS	
PRIMARY DOT	6
PRIMARY	4
SECONDARY DOT	1
SECONDARY	3
ISOLATE	2

Typical Performance Data

FREQUENCY (MHz)	INSERTION LOSS (dB)	RETURN LOSS (dB)
1300.00	0.36	9.53
1500.00	0.37	9.44
1700.00	0.55	9.57
1900.00	0.79	10.32
2000.00	0.88	10.97
2100.00	0.90	11.87
2200.00	0.90	12.89
2300.00	0.80	14.33
2400.00	0.69	16.40
2450.00	0.56	17.50
2500.00	0.52	19.09
2510.00	0.49	19.39
2520.00	0.49	19.69
2530.00	0.47	19.96
2540.00	0.46	20.15
2550.00	0.43	20.38
2560.00	0.41	20.58
2570.00	0.42	20.84
2580.00	0.38	21.10
2590.00	0.37	21.40
2600.00	0.36	21.64
2610.00	0.34	21.90
2620.00	0.34	22.10
2630.00	0.33	22.18
2640.00	0.37	22.17
2650.00	0.35	22.08
2660.00	0.35	21.85
2670.00	0.37	21.60
2680.00	0.37	21.29
2686.00	0.36	21.15
2700.00	0.36	20.75
2750.00	0.39	19.36
2800.00	0.48	17.25
2900.00	0.67	14.13
3000.00	0.79	13.35
3100.00	0.86	12.75
3200.00	0.93	12.25
3300.00	1.04	11.66
3500.00	1.05	11.65
3700.00	1.04	11.66

Typical Performance Curves

Insertion Loss

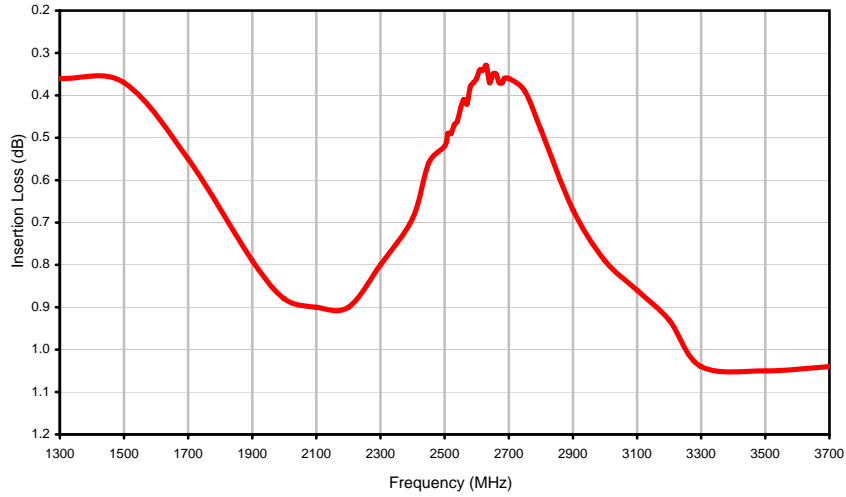

Return Loss

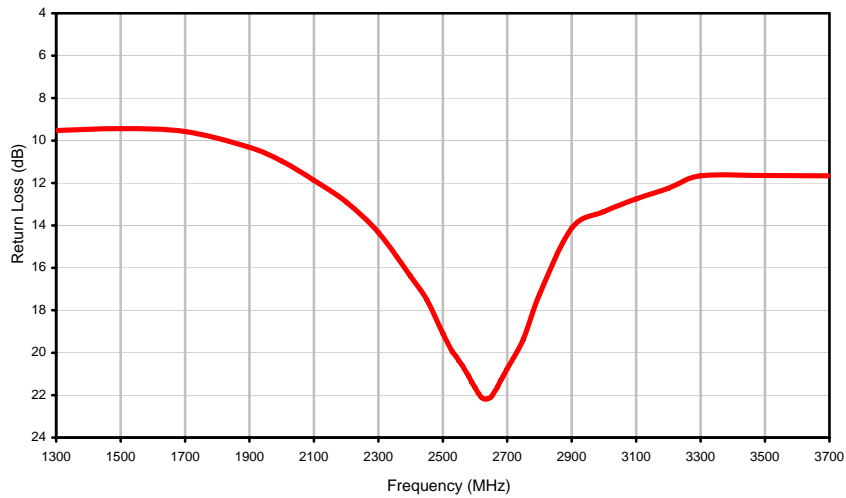

Outline Dimensions

AT224

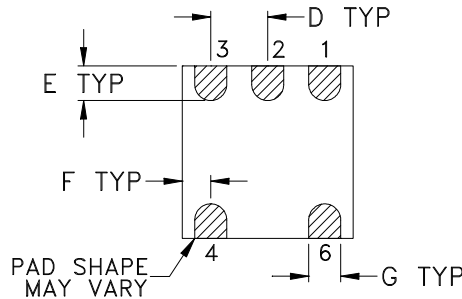
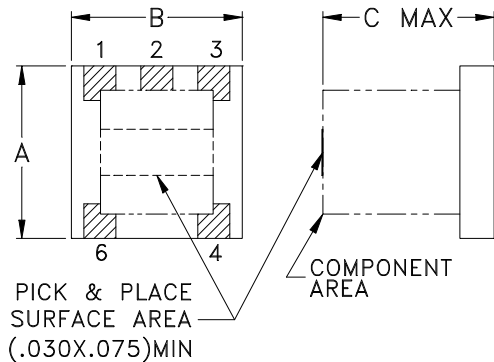

PCB Land Pattern

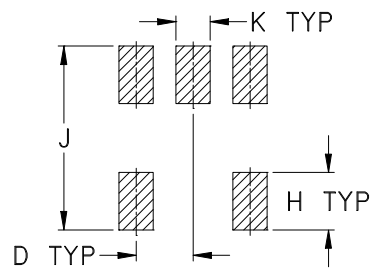

Suggested Layout,
Tolerance to be within $\pm .002$

CASE #	A	B	C	D	E	F	G	H	J	K	L	WT. GRAMS
AT224	.150 (3.81)	.150 (3.81)	.150 (3.81)	.050 (1.27)	.030 (0.76)	.025 (0.64)	.028 (0.71)	.065 (1.65)	.190 (4.83)	.030 (0.76)	-- --	.10

Dimensions are in inches (mm). Tolerances: 2 Pl. $\pm .01$; 3 Pl. $\pm .005$

Notes:

- Open style, ceramic base.
- Termination finish:
 - For RoHS Case Styles: 2-10 μ inch (.05-.25 microns) Gold over 100-300 μ inch (2.54-7.62 microns) Nickel plate. All models, (+) suffix.
 - For RoHS-5 Case Styles: Tin-Lead plate. All models, no (+) suffix.



P.O. Box 350166, Brooklyn, New York 11235-0003 (718) 934-4500 Fax (718) 332-4661 For detailed performance specs & shopping online see Mini-Circuits web site



The Design Engineers Search Engine Provides ACTUAL Data Instantly From MINI-CIRCUITS At: www.minicircuits.com

RF/IF MICROWAVE COMPONENTS

Tape & Reel Packaging TR-F17

DEVICE ORIENTATION IN T&R

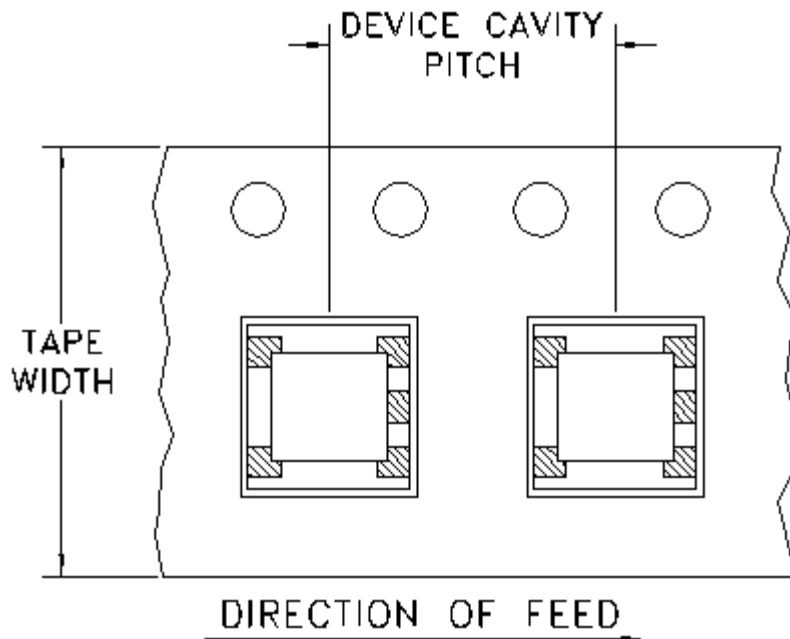

Tape Width, mm	Device Cavity Pitch, mm	Reel Size, inches	Devices per Reel	
12	8	7	Small quantity standards (see note)	20
				50
				100
				200
				500
		13	Standard	1000
			2000	

Note: Please Consult individual model data sheet to determine device per reel availability.

Mini-Circuits carrier tape materials provide protection from ESD (Electro-Static Discharge) during handling and transportation. Tapes are static dissipative and comply with industry standards EIA-481/EIA-541.

Go to: www.minicircuits.com/pages/pdfs/tape.pdf



P.O. Box 350166, Brooklyn, New York 11235-0003 (718) 934-4500 Fax (718) 332-4661 For detailed performance specs & shopping online see Mini-Circuits web site



The Design Engineers Search Engine Provides ACTUAL Data Instantly From MINI-CIRCUITS At: www.minicircuits.com

RF/IF MICROWAVE COMPONENTS

98-TR- Rev.: D (20 SEP 25) ECO-027008 File: 98-TR-F17 1

Sheet 1 of 1

This document and its contents are the property of Mini-Circuits.

Evaluation Board and Circuit

For Pin Connections refer to Data Sheet of the DUT

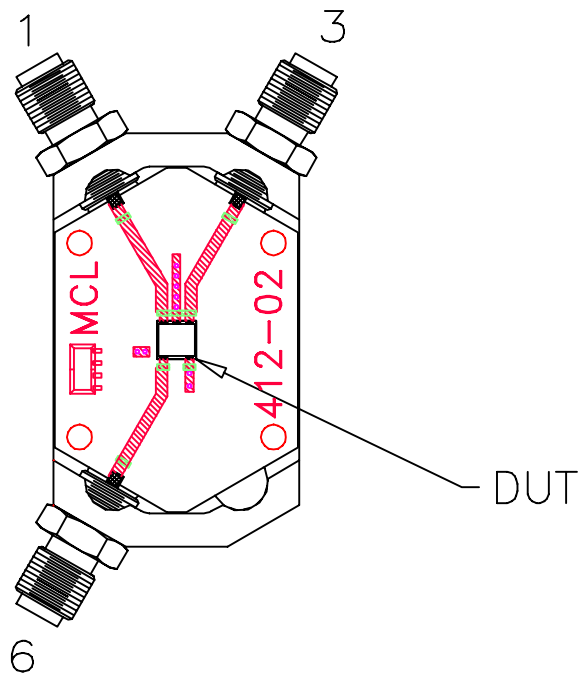

TB-145

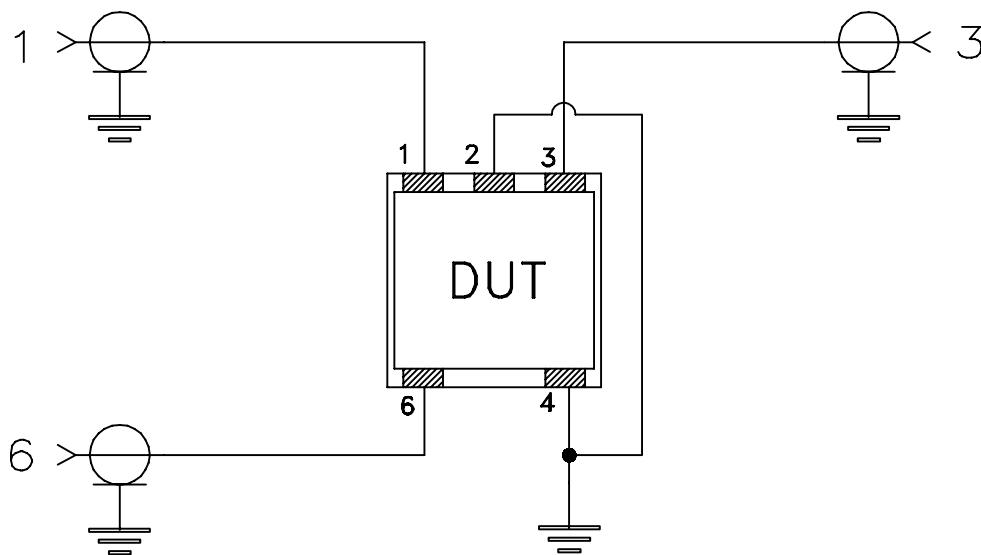

Schematic Diagram

Notes:

1. 50 Ohm SMA Female connectors.
2. PCB Material: Rogers RO4350B or its equivalent, Dielectric Constant=3.5, Thickness=.020"

 **Mini-Circuits®**



All Mini-Circuits products are manufactured under exacting quality assurance and control standards, and are capable of meeting published specifications after being subjected to any or all of the following physical and environmental test.

Specification	Test/Inspection Condition	Reference/Spec
Operating Temperature	-40° to 85°C Ambient Environment	Individual Model Data Sheet
Storage Temperature	-55° to 100° C Ambient Environment	Individual Model Data Sheet
Humidity	90 to 95% RH, 240 hours, 50°C	MIL-STD-202, Method 103, Condition A, Except 50°C and end-point electrical test done within 12 hours
Thermal Shock	-55° to 100°C, 100 cycles	MIL-STD-202, Method 107, Condition A-3, except +100°C
Solder Reflow Heat	Sn-Pb Eutetic Process: 225°C peak Pb-Free Process 245° - 250°C peak	J-STD-020, Table 4-1, 4-2 and 5-2, Figure 5-1
Solderability	10X Magnification	J-STD-002, 95% Coverage
Vibration (High Frequency)	20g peak, 10-2000 Hz, 12 times in each of three perpendicular directions (total 36)	MIL-STD-202, Method 204, Condition D
Mechanical Shock	50g, 11 ms, 1/2-sine, 18 shocks: 3 each direction, each of 3 axes	MIL-STD-202, Method 213, Condition A
Marking Resistance to Solvents	Isopropyl alcohol + mineral spirits at 25°C; terpene defluxer at 25°C; distilled water + proylene glycol monomethyl ether + monoethanolamine at 63°C to 70°C	MIL-STD-202, Method 215