

# Surface Mount RF Transformer

50Ω 0.5 to 550 MHz

## TC1.5-52T+



Generic photo used for illustration purposes only

CASE STYLE: AT224-1A

**+RoHS Compliant**

The +Suffix identifies RoHS Compliance. See our web site for RoHS Compliance methodologies and qualifications

Available Tape and Reel at no extra cost

| Reel Size | Devices/Reel          |
|-----------|-----------------------|
| 7"        | 20, 50, 100, 200, 500 |
| 13"       | 1000, 2000            |

### Features

- low insertion loss, 0.4 dB typ. in 1 dB Bandwidth
- excellent return loss, 25 dB typ. in 1 dB Bandwidth
- plastic base with leads
- aqueous washable

### Applications

- impedance matching, 50 to 75 ohms
- balanced amplifier

### Electrical Specifications at 25°C

| Parameter                           | Frequency (MHz) | Min. | Typ. | Max. | Unit |
|-------------------------------------|-----------------|------|------|------|------|
| Impedance Ratio (Secondary/Primary) |                 |      | 1.5  |      | Ohm  |
| Frequency Range                     |                 | 0.5  |      | 550  | MHz  |
| Insertion Loss*                     | 0.5-550         |      | 3    |      | dB   |
|                                     | 1-350           |      | 2    |      |      |
|                                     | 2-200           |      | 1    |      |      |

\*Insertion Loss is referenced to mid-band loss, 0.4 dB typ.

### Maximum Ratings

| Parameter             | Ratings        |
|-----------------------|----------------|
| Operating Temperature | -40°C to 85°C  |
| Storage Temperature   | -55°C to 100°C |
| RF Power              | 0.25W          |
| DC Current            | 30mA           |

Permanent damage may occur if any of these limits are exceeded.

### Pin Connections

| Function      | Pin Number |
|---------------|------------|
| PRIMARY DOT   | 6          |
| PRIMARY       | 4          |
| SECONDARY DOT | 1          |
| SECONDARY CT  | 2          |
| SECONDARY     | 3          |
| NOT USED      | 5          |

### Config. A

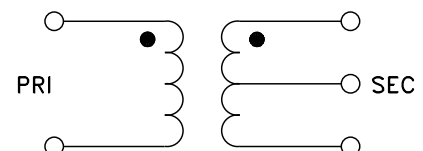

REV. C  
M151107  
ED-12687/1  
TC1.5-52T+  
IG/TD/CP/AM  
210412

## Outline Drawing

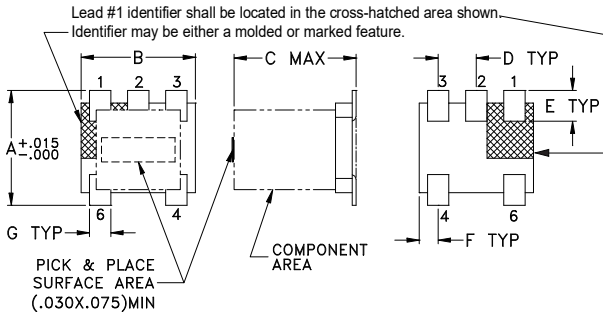

## PCB Land Pattern

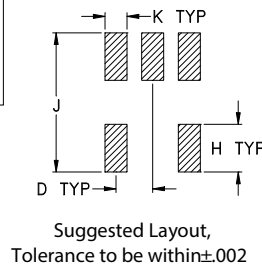

## Demo Board MCL P/N: TB-145 Suggested PCB Layout (PL-244)

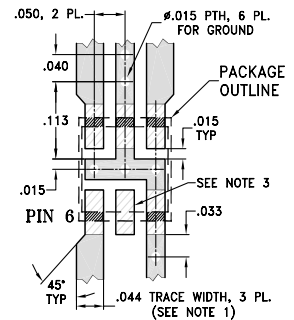

## Outline Dimensions (inch/mm)

| A    | B    | C    | D    | E     | F    |
|------|------|------|------|-------|------|
| .150 | .150 | .160 | .050 | .040  | .025 |
| 3.81 | 3.81 | 4.06 | 1.27 | 1.02  | 0.64 |
| G    | H    | J    | K    | wt    |      |
| .028 | .065 | .190 | .030 | grams |      |
| 0.71 | 1.65 | 4.83 | 0.76 | 0.15  |      |

## NOTES:

- THICKNESS  $.020" \pm .0015"$ ; COPPER: 1/2 OZ. ON EACH SIDE. FOR OTHER MATERIALS TRACE WIDTH MAY NEED TO BE MODIFIED.
  - BOTTOM SIDE OF THE PCB IS CONTINUOUS GROUND PLANE.
  - THIS PAD IS NOT REQUIRED FOR AT224 CASE STYLE.
- DENOTES PCB COPPER LAYOUT WITH SMOBC (SOLDER MASK OVER BARE COPPER)  
 DENOTES COPPER LAND PATTERN FREE OF SOLDER MASK

## Typical Performance Data

| FREQUENCY (MHz) | INSERTION LOSS (dB) | INPUT R. LOSS (dB) |
|-----------------|---------------------|--------------------|
| 0.50            | 0.82                | 15.72              |
| 1.00            | 0.61                | 19.84              |
| 5.00            | 0.33                | 28.81              |
| 10.00           | 0.29                | 32.35              |
| 50.00           | 0.35                | 28.60              |
| 100.00          | 0.41                | 23.52              |
| 200.00          | 0.53                | 18.07              |
| 250.00          | 0.61                | 16.13              |
| 300.00          | 0.70                | 14.71              |
| 400.00          | 0.90                | 12.52              |
| 550.00          | 1.28                | 10.19              |

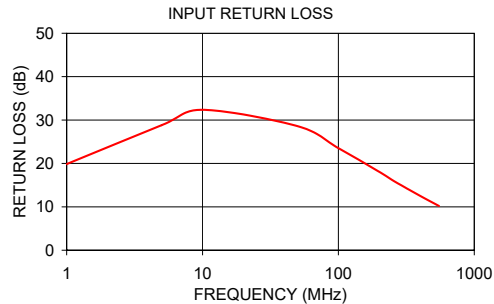

## Additional Notes

- Performance and quality attributes and conditions not expressly stated in this specification document are intended to be excluded and do not form a part of this specification document.
- Electrical specifications and performance data contained in this specification document are based on Mini-Circuits' applicable established test performance criteria and measurement instructions.
- The parts covered by this specification document are subject to Mini-Circuits standard limited warranty and terms and conditions (collectively, "Standard Terms"); Purchasers of this part are entitled to the rights and benefits contained therein. For a full statement of the Standard Terms and the exclusive rights and remedies thereunder, please visit Mini-Circuits' website at [www.minicircuits.com/MCLStore/terms.jsp](http://www.minicircuits.com/MCLStore/terms.jsp)

## Typical Performance Data

| FREQUENCY<br>(MHz) | INSERTION<br>LOSS<br>(dB) | RETURN<br>LOSS<br>(dB) |
|--------------------|---------------------------|------------------------|
| 0.30               | 1.05                      | 12.47                  |
| 0.50               | 0.82                      | 15.72                  |
| 0.70               | 0.71                      | 17.77                  |
| 0.90               | 0.64                      | 19.24                  |
| 1.00               | 0.61                      | 19.84                  |
| 1.50               | 0.51                      | 22.09                  |
| 2.00               | 0.46                      | 23.68                  |
| 2.50               | 0.42                      | 24.91                  |
| 3.00               | 0.39                      | 25.93                  |
| 3.50               | 0.37                      | 26.79                  |
| 4.00               | 0.35                      | 27.55                  |
| 4.50               | 0.34                      | 28.20                  |
| 5.00               | 0.33                      | 28.81                  |
| 10.00              | 0.29                      | 32.35                  |
| 30.00              | 0.32                      | 32.20                  |
| 50.00              | 0.35                      | 28.60                  |
| 70.00              | 0.37                      | 26.53                  |
| 90.00              | 0.41                      | 24.54                  |
| 100.00             | 0.41                      | 23.52                  |
| 140.00             | 0.46                      | 21.01                  |
| 180.00             | 0.51                      | 18.67                  |
| 200.00             | 0.53                      | 18.07                  |
| 250.00             | 0.61                      | 16.13                  |
| 300.00             | 0.70                      | 14.71                  |
| 350.00             | 0.78                      | 13.58                  |
| 400.00             | 0.90                      | 12.52                  |
| 450.00             | 0.97                      | 11.61                  |
| 500.00             | 1.09                      | 10.84                  |
| 550.00             | 1.28                      | 10.19                  |
| 600.00             | 1.36                      | 9.65                   |
| 700.00             | 1.68                      | 8.49                   |
| 800.00             | 2.13                      | 7.80                   |

## Typical Performance Curves

### Insertion Loss

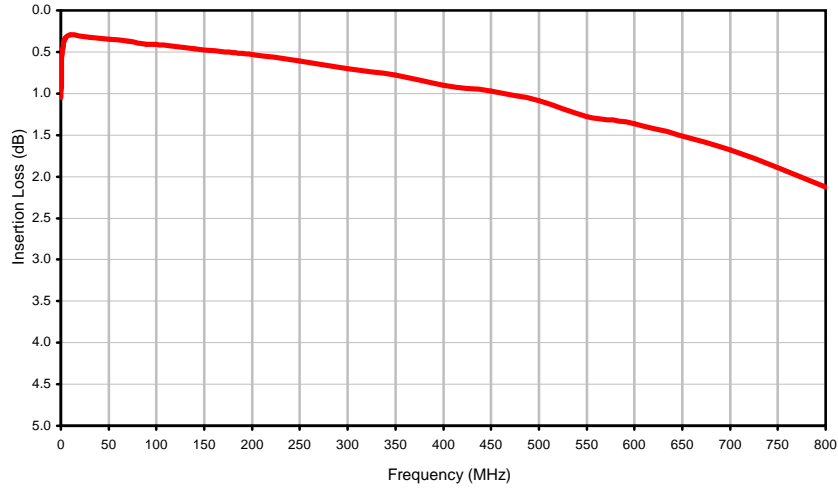

### Return Loss

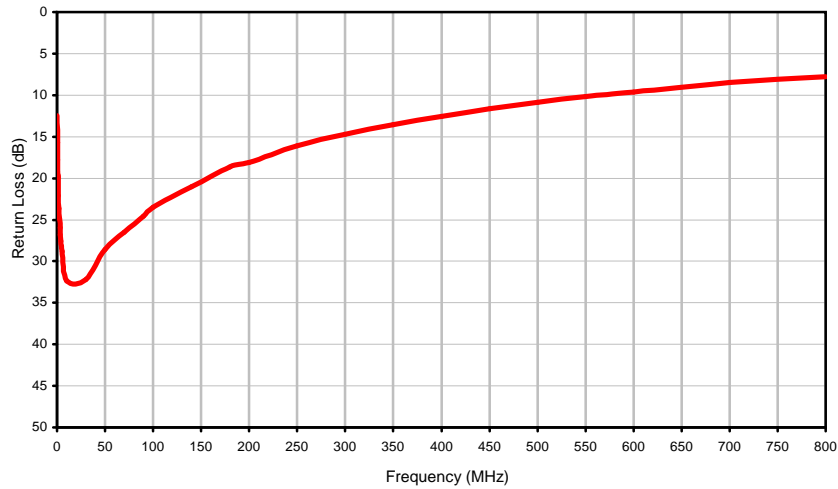

## Outline Dimensions

AT224-1A

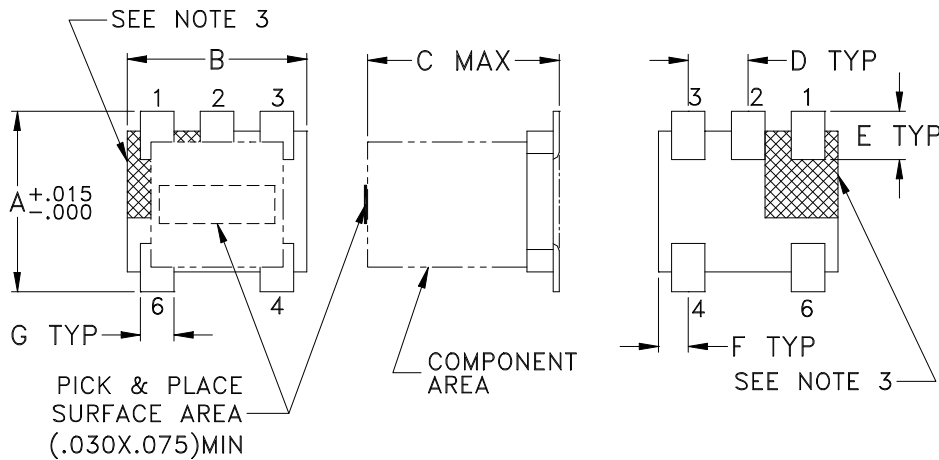

## PCB Land Pattern

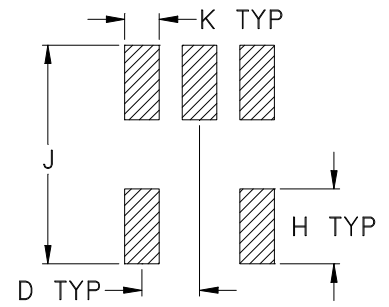

Suggested Layout,  
Tolerance to be within  $\pm .002$

| CASE #   | A              | B              | C              | D              | E              | F              | G              | H              | J              | K              | WT. GRAMS |
|----------|----------------|----------------|----------------|----------------|----------------|----------------|----------------|----------------|----------------|----------------|-----------|
| AT224-1A | .150<br>(3.81) | .150<br>(3.81) | .160<br>(4.06) | .050<br>(1.27) | .040<br>(1.02) | .025<br>(0.64) | .028<br>(0.71) | .065<br>(1.65) | .190<br>(4.83) | .030<br>(0.76) | .15       |

Dimensions are in inches (mm). Tolerances: 2 Pl.  $\pm .01$ ; 3 Pl.  $\pm .005$

### Notes:

- Case material: Plastic.
- Termination finish:  
For RoHS Case Styles: Tin plate over Nickel plate. All models, (+) suffix.
- Lead #1 identifier shall be located in the cross-hatched area shown.  
Identifier may be either a molded or marked feature.



P.O. Box 350166, Brooklyn, New York 11235-0003 (718) 934-4500 Fax (718) 332-4661 For detailed performance specs & shopping online see Mini-Circuits web site



The Design Engineers Search Engine Provides ACTUAL Data Instantly From MINI-CIRCUITS At: [www.minicircuits.com](http://www.minicircuits.com)

RF/MICROWAVE COMPONENTS

# Tape & Reel Packaging TR-F17

## DEVICE ORIENTATION IN T&R

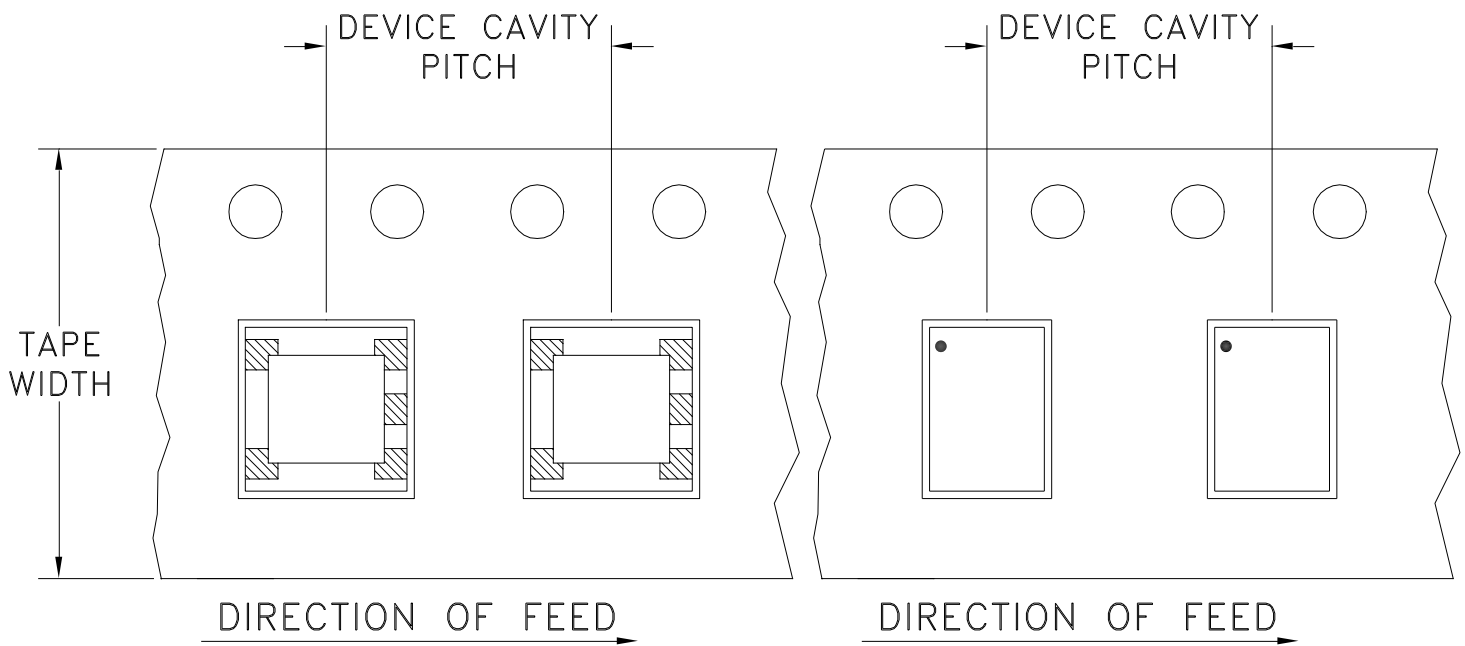

| Tape Width, mm | Device Cavity Pitch, mm | Reel Size, inches | Devices per Reel                    |      |
|----------------|-------------------------|-------------------|-------------------------------------|------|
| 12             | 8                       | 7                 | Small quantity standards (see note) | 20   |
|                |                         |                   |                                     | 50   |
|                |                         |                   |                                     | 100  |
|                |                         |                   |                                     | 200  |
|                |                         |                   |                                     | 500  |
|                |                         | 13                | Standard                            | 1000 |
|                |                         | 2000              |                                     |      |

Note: Please Consult individual model data sheet to determine device per reel availability.

Mini-Circuits carrier tape materials provide protection from ESD (Electro-Static Discharge) during handling and transportation. Tapes are static dissipative and comply with industry standards EIA-481/EIA-541.

Go to: [www.minicircuits.com/pages/pdfs/tape.pdf](http://www.minicircuits.com/pages/pdfs/tape.pdf)



P.O. Box 350166, Brooklyn, New York 11235-0003 (718) 934-4500 Fax (718) 332-4661 For detailed performance specs & shopping online see Mini-Circuits web site



The Design Engineers Search Engine Provides ACTUAL Data Instantly From MINI-CIRCUITS At: [www.minicircuits.com](http://www.minicircuits.com)

RF/IF MICROWAVE COMPONENTS

THIRD ANGLE PROJECTION

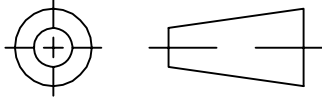

REVISIONS

| REV | ECN No. | DESCRIPTION | DATE     | DR | AUTH |
|-----|---------|-------------|----------|----|------|
| OR  | M106563 | NEW RELEASE | 08/23/06 | AV | IG   |
|     |         |             |          |    |      |
|     |         |             |          |    |      |

SUGGESTED MOUNTING CONFIGURATION  
FOR AT224/DB714 CASE STYLE, "gs/ha/hd" PIN CONNECTIONS  
(FOR SINGLE ENDED TO BALANCED APPLICATION)

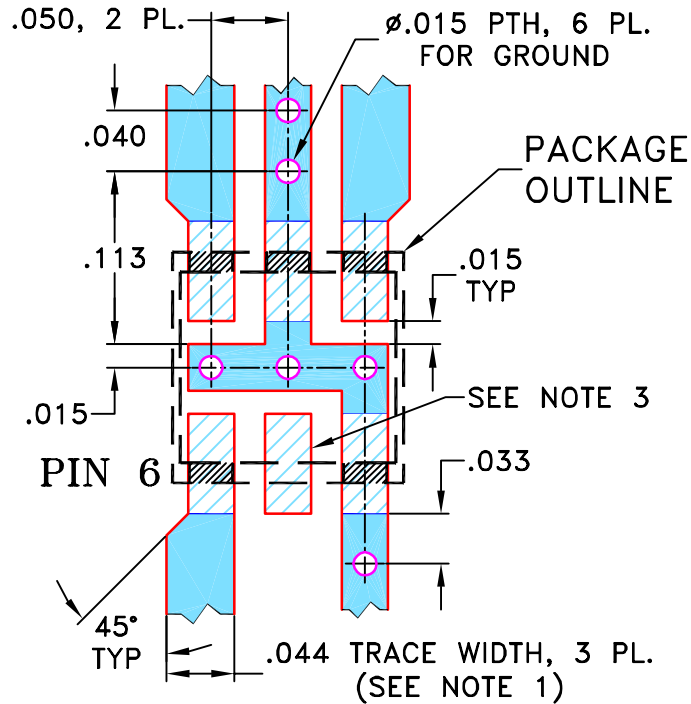

- NOTES:** 1. TRACE WIDTH IS SHOWN FOR ROGERS RO4350B WITH DIELECTRIC THICKNESS .020" ± .0015"; COPPER: 1/2 OZ. ON EACH SIDE. FOR OTHER MATERIALS TRACE WIDTH MAY NEED TO BE MODIFIED.  
 2. BOTTOM SIDE OF THE PCB IS CONTINUOUS GROUND PLANE.  
 3. THIS PAD IS NOT REQUIRED FOR AT224 CASE STYLE.

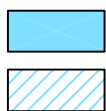

DENOTES PCB COPPER LAYOUT WITH SMOBC (SOLDER MASK OVER BARE COPPER)  
 DENOTES COPPER LAND PATTERN FREE OF SOLDER MASK

UNLESS OTHERWISE SPECIFIED

INITIALS      DATE

DIMENSIONS ARE IN INCHES  
 TOLERANCES ON:  
 2 PL DECIMALS ±  
 3 PL DECIMALS ± .005  
 ANGLES ±  
 FRACTIONS ±

|          |    |          |
|----------|----|----------|
| DRAWN    | AV | 07/28/06 |
| CHECKED  | IL | 08/23/06 |
| APPROVED | IG | 08/23/06 |



**Mini-Circuits®**

13 Neptune Avenue  
 Brooklyn NY 11235

PL, gs/ha/hd, AT224/DB714, TC/TCM, TB-145

THIS DOCUMENT AND ITS CONTENTS ARE THE PROPERTY OF MINI-CIRCUITS. EXCEPT FOR USE EXPRESSLY GRANTED, IN WRITING, TO ITS VENDORS, VENDEE AND THE UNITED STATES GOVERNMENT, MINI-CIRCUITS RESERVES ALL PROPRIETARY DESIGN, USE, MANUFACTURING AND REPRODUCTION RIGHTS THERETO. THESE CONTENTS SHALL NOT BE USED, DUPLICATED OR DISCLOSED TO ANY OUTSIDE PARTY, IN WHOLE OR IN PART, WITHOUT WRITTEN PERMISSION OF MINI-CIRCUITS.

|           |                     |                          |            |
|-----------|---------------------|--------------------------|------------|
| SIZE<br>A | CODE IDENT<br>15542 | DRAWING NO:<br>98-PL-244 | REV:<br>OR |
|-----------|---------------------|--------------------------|------------|

|                  |               |                  |
|------------------|---------------|------------------|
| FILE:<br>98PL244 | SCALE:<br>8:1 | SHEET:<br>1 OF 1 |
|------------------|---------------|------------------|

# Evaluation Board and Circuit

For Pin Connections refer to Data Sheet of the DUT



TB-145

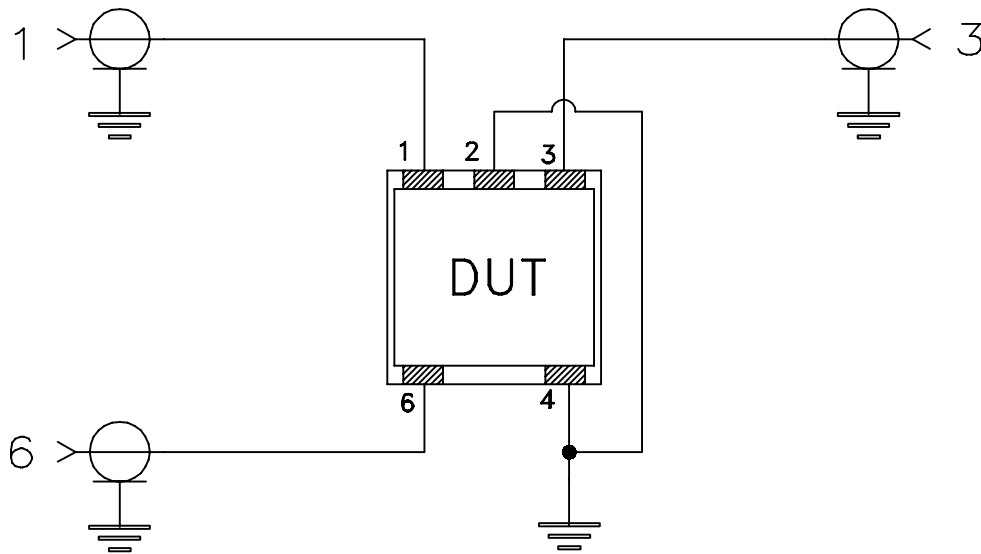

Schematic Diagram

## Notes:

1. 50 Ohm SMA Female connectors.
2. PCB Material: Rogers RO4350B or its equivalent, Dielectric Constant=3.5, Thickness=.020"

 **Mini-Circuits®**



All Mini-Circuits products are manufactured under exacting quality assurance and control standards, and are capable of meeting published specifications after being subjected to any or all of the following physical and environmental test.

| Specification                  | Test/Inspection Condition   | Reference/Spec   |
|--------------------------------|---|--|
| Operating Temperature          | -40° to 85°C<br>Ambient Environment   | Individual Model Data Sheet  |
| Storage Temperature            | -55° to 100° C<br>Ambient Environment   | Individual Model Data Sheet  |
| Humidity                       | 90 to 95% RH, 240 hours, 50°C   | MIL-STD-202, Method 103, Condition A, Except 50°C and end-point electrical test done within 12 hours |
| Thermal Shock                  | -55° to 100°C, 100 cycles   | MIL-STD-202, Method 107, Condition A-3, except +100°C  |
| Solder Reflow Heat             | Sn-Pb Eutetic Process: 225°C peak<br>Pb-Free Process 245° - 250°C peak  | J-STD-020, Table 4-1, 4-2 and 5-2, Figure 5-1  |
| Solderability                  | 10X Magnification   | J-STD-002, 95% Coverage  |
| Vibration (High Frequency)     | 20g peak, 10-2000 Hz, 12 times in each of three perpendicular directions (total 36)   | MIL-STD-202, Method 204, Condition D   |
| Mechanical Shock               | 50g, 11 ms, 1/2-sine, 18 shocks: 3 each direction, each of 3 axes   | MIL-STD-202, Method 213, Condition A   |
| Marking Resistance to Solvents | Isopropyl alcohol + mineral spirits at 25°C; terpene defluxer at 25°C;<br>distilled water + proylene glycol monomethyl ether + monoethanolamine at 63°C to 70°C | MIL-STD-202, Method 215  |