

Surface Mount ^{top hat}
RF Transformer
 50Ω 2 to 1100 MHz

TC4-11X+



Generic photo used for illustration purposes only

CASE STYLE: AT1521

+RoHS Compliant
 The +Suffix identifies RoHS Compliance.
 See our website for methodologies and qualifications

Available Tape and Reel at no extra cost

Reel Size	Devices/Reel
7"	20, 50, 100, 200, 500
13"	1000, 2000

Features

- wideband 2-1100 MHz
- good return loss
- terminations, solder plated with nickel barrier for solderability and excellent leach resistance
- step-down autotransformer
- plastic base with leads
- aqueous washable

Applications

- cellular

Electrical Specifications at 25°C

Parameter	Condition	Min.	Typ.	Max.	Unit
Impedance Ratio (primary/ secondary)			50/12.5		Ohm
Frequency Range		2		1100	MHz
Insertion Loss*	—		3.0		dB
	2-1100		2.0		
	5-700		1.0		

* Insertion Loss is referenced to mid-band loss, 0.4 dB typ.
 Stepdown, 50 ohm primary, 5.2 pF across secondary

Maximum Ratings

Parameter	Ratings
Operating Temperature	-20°C to 85°C
Storage Temperature	-55°C to 100°C
RF Power	0.25W
DC Current	30mA

Permanent damage may occur if any of these limits are exceeded.

Pin Connections

Function	Pin Number
PRIMARY DOT	6
PRIMARY	3
SECONDARY DOT	1
SECONDARY	3

Product Marking

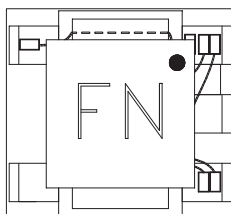

Config. D

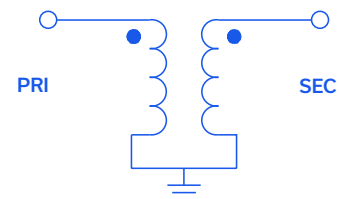

Outline Drawing

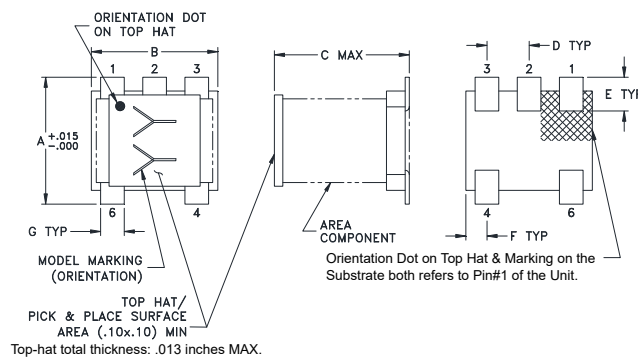

PCB Land Pattern

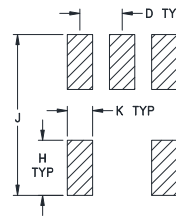

Suggested Layout,
Tolerance to be within ± 0.02

Outline Dimensions (inches / mm)

A	B	C	D	E	F	G	H	J
.150	.150	.160	.050	.040	.025	.028	.065	.190
3.81	3.81	4.06	1.27	1.02	0.64	0.71	1.65	4.83

Typical Performance Data

FREQUENCY (MHz)	INSERTION LOSS (dB)	INPUT R. LOSS (dB)
1.00	0.63	20.35
5.00	0.36	31.19
50.00	0.37	40.18
100.00	0.39	36.30
300.00	0.43	26.86
500.00	0.53	21.49
700.00	0.64	18.96
800.00	0.71	18.37
1000.00	0.89	19.97
1120.00	1.10	19.69

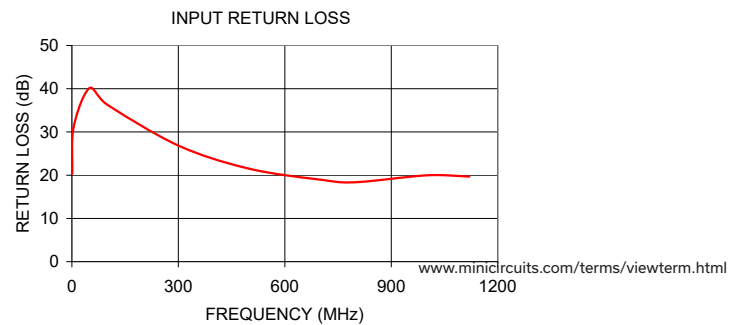
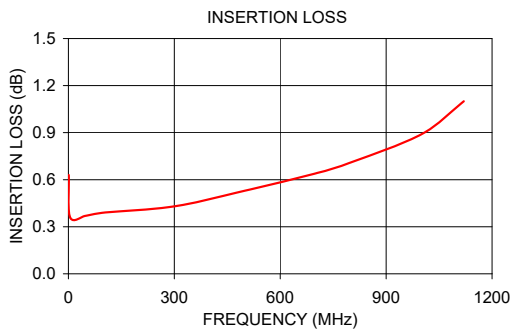

Additional Notes

- A. Performance and quality attributes and conditions not expressly stated in this specification document are intended to be excluded and do not form a part of this specification document.
- B. Electrical specifications and performance data contained in this specification document are based on Mini-Circuit's applicable established test performance criteria and measurement instructions.
- C. The parts covered by this specification document are subject to Mini-Circuits standard limited warranty and terms and conditions (collectively, "Standard Terms"); Purchasers of this part are entitled to the rights and benefits contained therein. For a full statement of the Standard Terms and the exclusive rights and remedies thereunder, please visit Mini-Circuits' website at www.minicircuits.com/terms/viewterm.html

RF Transformer

TC4-11X+

Typical Performance Data

FREQUENCY (MHz)	INSERTION LOSS (dB)	RETURN LOSS (dB)
1.00	0.63	20.35
5.00	0.36	31.19
50.00	0.37	40.18
100.00	0.39	36.30
300.00	0.43	26.86
500.00	0.53	21.49
700.00	0.64	18.96
800.00	0.71	18.37
1000.00	0.89	19.97
1120.00	1.10	19.69



P.O. Box 350166, Brooklyn, New York 11235-0003 (718) 934-4500 • Fax (718) 332-4661 For detailed performance specs & shopping online see Mini-Circuits web site
 The Design Engineers Search Engine Provides ACTUAL Data Instantly From MINI-CIRCUITS At: www.minicircuits.com

IF/RF MICROWAVE COMPONENTS

REV. X1
TC4-11X+
2/1/2012
Page 1 of 1

Typical Performance Data

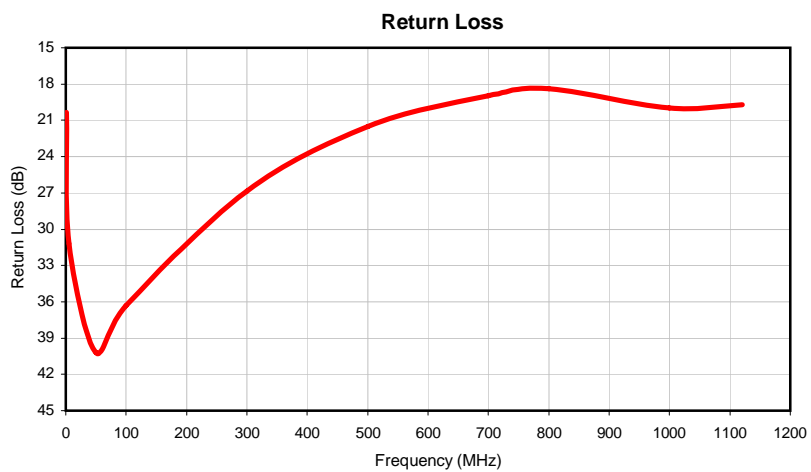
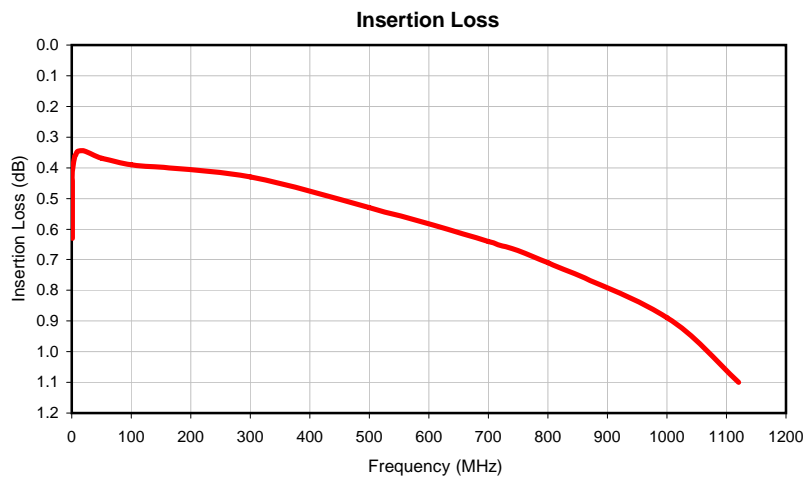

Outline Dimensions

AT1521

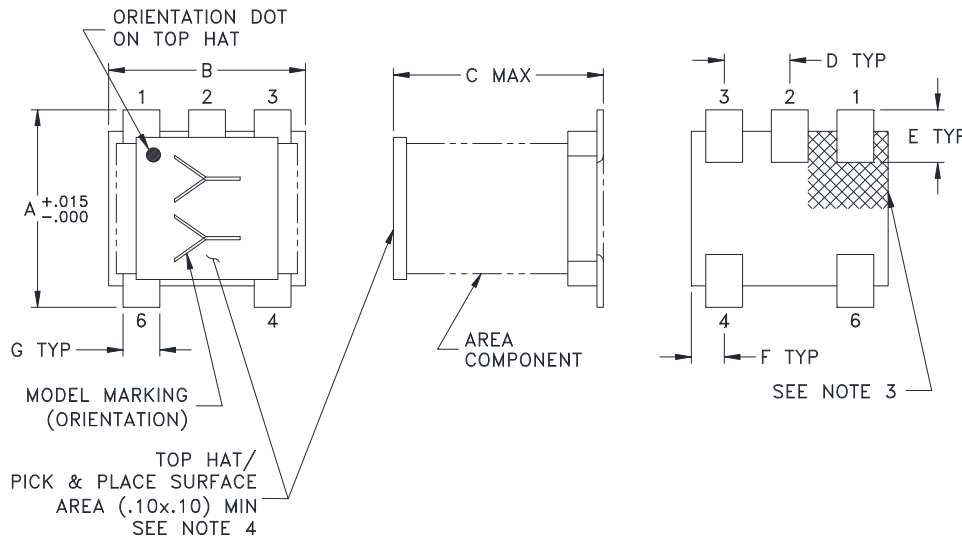

PCB Land Pattern

Suggested Layout,
Tolerance to be within $\pm .002$

CASE #	A	B	C	D	E	F	G	H	J	K	WT. GRAMS
AT1521	.150 (3.81)	.150 (3.81)	.160 (4.06)	.050 (1.27)	.040 (1.02)	.025 (.64)	.028 (.71)	.065 (1.65)	.190 (4.83)	.030 (.76)	.15

Dimensions are in inches (mm). Tolerances: 2 Pl. $\pm .01$; 3 Pl. $\pm .005$

Notes:

1. Case material: Plastic.
2. Termination finish:
For RoHS Case Styles: Tin plate over Nickel plate. All models, (+) suffix.
3. Orientation Dot on Top Hat & Marking on the Substrate both refers to Pin #1 of the Unit.
4. Top-Hat total thickness: .013 inches MAX.



P.O. Box 350186, Brooklyn, New York 11235-0003 (718) 934-4500 Fax (718) 332-4661 For detailed performance specs & shopping online see Mini-Circuits web site



The Design Engineers Search Engine Provides ACTUAL Data Instantly From MINI-CIRCUITS At: www.minicircuits.com

RF/IF MICROWAVE COMPONENTS

Tape & Reel Packaging TR-F17

DEVICE ORIENTATION IN T&R

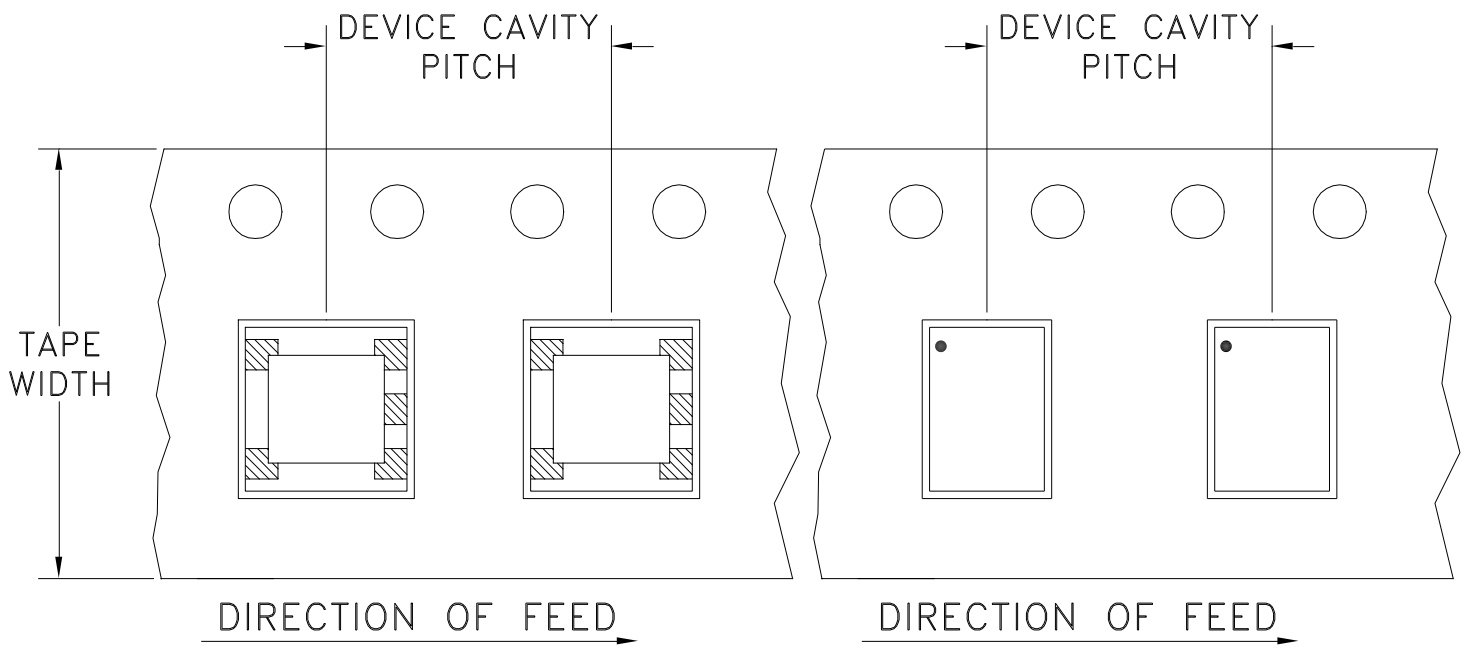

Tape Width, mm	Device Cavity Pitch, mm	Reel Size, inches	Devices per Reel	
12	8	7	Small quantity standards (see note)	20
				50
				100
				200
				500
		13	Standard	1000
2000				

Note: Please Consult individual model data sheet to determine device per reel availability.

Mini-Circuits carrier tape materials provide protection from ESD (Electro-Static Discharge) during handling and transportation. Tapes are static dissipative and comply with industry standards EIA-481/EIA-541.

Go to: www.minicircuits.com/pages/pdfs/tape.pdf



P.O. Box 350166, Brooklyn, New York 11235-0003 (718) 934-4500 Fax (718) 332-4661 For detailed performance specs & shopping online see Mini-Circuits web site



The Design Engineers Search Engine Provides ACTUAL Data Instantly From MINI-CIRCUITS At: www.minicircuits.com

RF/IF MICROWAVE COMPONENTS

All Mini-Circuits products are manufactured under exacting quality assurance and control standards, and are capable of meeting published specifications after being subjected to any or all of the following physical and environmental test.

Specification	Test/Inspection Condition	Reference/Spec
Operating Temperature	-20° to 85°C Ambient Environment	Individual Model Data Sheet
Storage Temperature	-55° to 100° C Ambient Environment	Individual Model Data Sheet
Humidity	90 to 95% RH, 240 hours, 50°C	MIL-STD-202, Method 103, Condition A, Except 50°C and end-point electrical test done within 12 hours
Thermal Shock	-55° to 100°C, 100 cycles	MIL-STD-202, Method 107, Condition A-3, except +100°C
Solder Reflow Heat	Sn-Pb Eutetic Process: 225°C peak Pb-Free Process 245° - 250°C peak	J-STD-020, Table 4-1, 4-2 and 5-2, Figure 5-1
Solderability	10X Magnification	J-STD-002, 95% Coverage
Vibration (High Frequency)	20g peak, 10-2000 Hz, 12 times in each of three perpendicular directions (total 36)	MIL-STD-202, Method 204, Condition D
Mechanical Shock	50g, 11 ms, 1/2-sine, 18 shocks: 3 each direction, each of 3 axes	MIL-STD-202, Method 213, Condition A
Marking Resistance to Solvents	Isopropyl alcohol + mineral spirits at 25°C; terpene defluxer at 25°C; distilled water + proylene glycol monomethyl ether + monoethanolamine at 63°C to 70°C	MIL-STD-202, Method 215