

Surface Mount RF Transformer

TC4-1T

50Ω

0.5 to 300 MHz

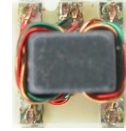

CASE STYLE: AT224
PRICE: Contact Sales Dept.

Maximum Ratings

Operating Temperature	-20°C to 85°C
Storage Temperature	-55°C to 100°C
RF Power	.25W
DC Current	30mA

Permanent damage may occur if any of these limits are exceeded.

Pin Connections

PRIMARY DOT	6
PRIMARY	4
SECONDARY DOT	1
SECONDARY	3
SECONDARY CT	2
NOT USED	5

Features

- wide band 0.5-300 MHz, usable over 0.2-450 MHz
- good return loss
- impedance matching
- leadless surface mount
- aqueous washable

Applications

- catv

Transformer Electrical Specifications

Ω RATIO <i>(Secondary/Primary)</i>	FREQUENCY (MHz)	INSERTION LOSS*		
		3 dB MHz	2 dB MHz	1 dB MHz
4	0.5-300	—	0.5-300	1.5-100

* Insertion Loss is referenced to mid-band loss, 0.3 dB typ.

NON-CATALOG

Outline Drawing AT224

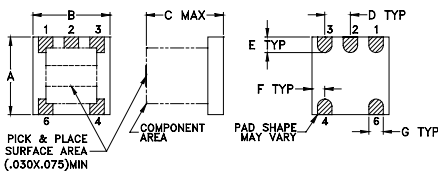

PCB Land Pattern

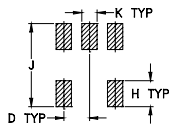

Outline Dimensions (inch/mm)

A	B	C	D	E	F
.150	.150	.150	.050	.030	.025
3.81	3.81	3.81	1.27	0.76	0.64
G	H	J	K	wt	
.028	.065	.190	.030	grams	
0.71	1.65	4.83	0.76	0.10	

Typical Performance Data

FREQUENCY (MHz)	INSERTION LOSS (dB)	INPUT R. LOSS (dB)
0.50	0.51	16.81
1.00	0.44	20.73
10.00	0.27	30.31
50.00	0.30	32.32
70.00	0.32	30.95
100.00	0.36	28.39
150.00	0.40	24.12
200.00	0.45	20.32
250.00	0.54	17.09
300.00	0.62	14.29

Config. A

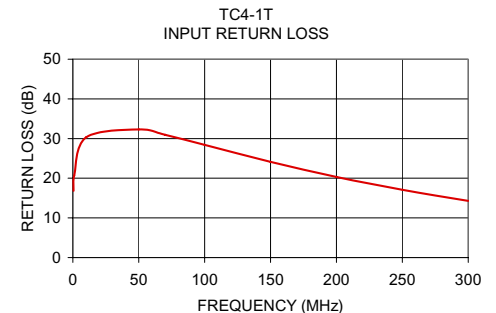
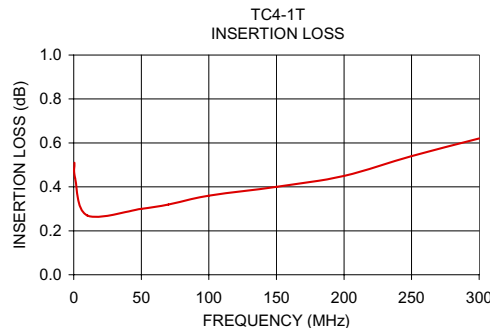
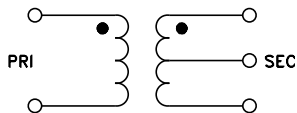

Mini-Circuits[®]
ISO 9001 ISO 14001 AS 9100 CERTIFIED

P.O. Box 350166, Brooklyn, New York 11235-0003 (718) 934-4500 Fax (718) 332-4661 The Design Engineers Search Engine Provides ACTUAL Data Instantly at minicircuits.com

For detailed performance specs & shopping online see web site

Notes: 1. Performance and quality attributes and conditions not expressly stated in this specification sheet are intended to be excluded and do not form a part of this specification sheet. 2. Electrical specifications and performance data contained herein are based on Mini-Circuit's applicable established test performance criteria and measurement instructions. 3. The parts covered by this specification sheet are subject to Mini-Circuits standard limited warranty and terms and conditions (collectively, "Standard Terms"); Purchasers of this part are entitled to the rights and benefits contained therein. For a full statement of the Standard Terms and the exclusive rights and remedies thereunder, please visit Mini-Circuits' website at www.minicircuits.com/MCLStore/terms.jsp.

REV. C
M125008
TC4-1T
ED-6398/2
IG/TD/CP/AM
091019

Typical Performance Data

FREQUENCY (MHz)	INSERTION LOSS (dB)	RETURN LOSS (dB)
0.50	0.51	16.81
1.00	0.44	20.73
10.00	0.27	30.31
50.00	0.30	32.32
70.00	0.32	30.95
100.00	0.36	28.39
150.00	0.40	24.12
200.00	0.45	20.32
250.00	0.54	17.09
300.00	0.62	14.29

Typical Performance Curves

Insertion Loss

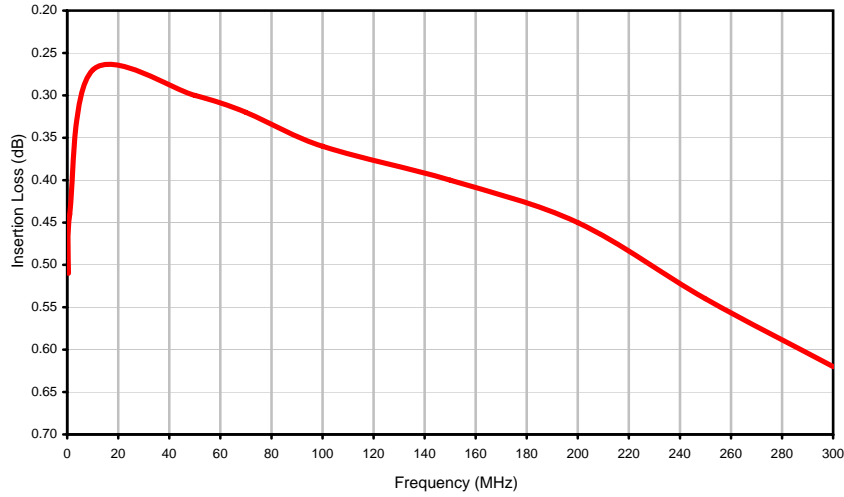

Return Loss

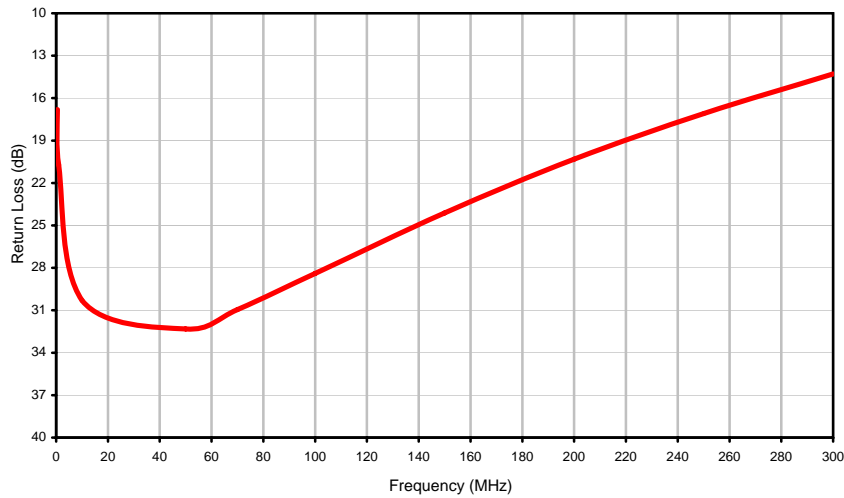

Outline Dimensions

AT224

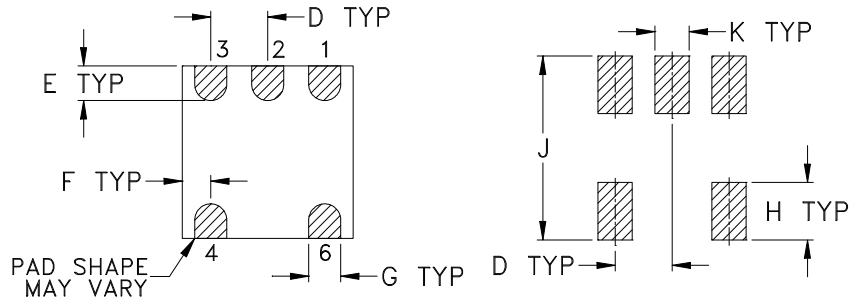
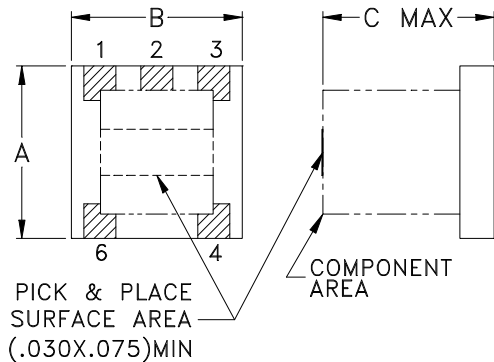

Suggested Layout,
Tolerance to be within ± 0.002

CASE #	A	B	C	D	E	F	G	H	J	K	L	WT. GRAMS
AT224	.150 (3.81)	.150 (3.81)	.150 (3.81)	.050 (1.27)	.030 (0.76)	.025 (0.64)	.028 (0.71)	.065 (1.65)	.190 (4.83)	.030 (0.76)	-- --	.10

Dimensions are in inches (mm). Tolerances: 2 Pl. $\pm .01$; 3 Pl. $\pm .005$

Notes:

- Open style, ceramic base.
- Termination finish:
 - For RoHS Case Styles: 2-10 μ inch (.05-.25 microns) Gold over 100-300 μ inch (2.54-7.62 microns) Nickel plate.
 - All models, (+) suffix.
 - For RoHS-5 Case Styles: Tin-Lead plate. All models, no (+) suffix.



P.O. Box 350166, Brooklyn, New York 11235-0003 (718) 934-4500 Fax (718) 332-4661 For detailed performance specs & shopping online see Mini-Circuits web site



The Design Engineers Search Engine Provides ACTUAL Data Instantly From MINI-CIRCUITS At: www.minicircuits.com

RF/IF MICROWAVE COMPONENTS

Tape & Reel Packaging TR-F17

DEVICE ORIENTATION IN T&R

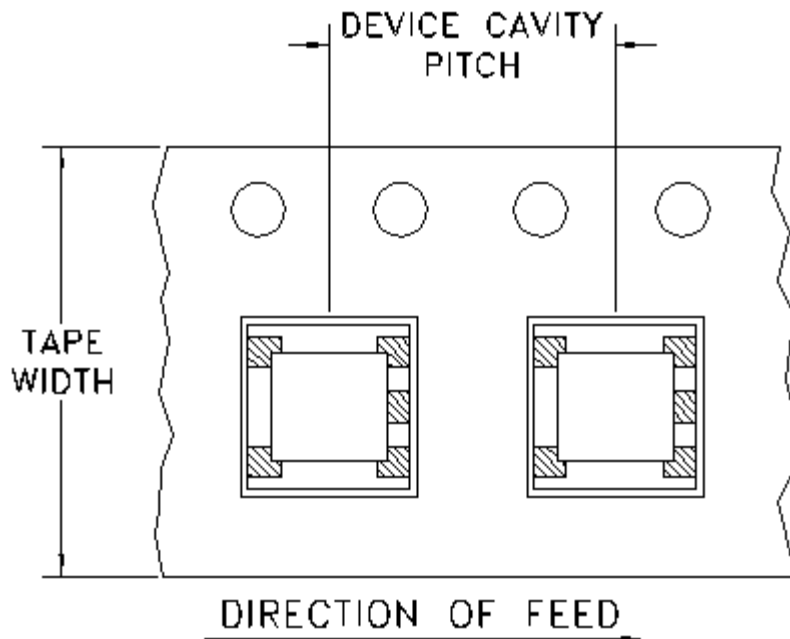

Tape Width, mm	Device Cavity Pitch, mm	Reel Size, inches	Devices per Reel	
12	8	7	Small quantity standards (see note)	20
				50
				100
				200
				500
		13	Standard	1000
			2000	

Note: Please Consult individual model data sheet to determine device per reel availability.

Mini-Circuits carrier tape materials provide protection from ESD (Electro-Static Discharge) during handling and transportation. Tapes are static dissipative and comply with industry standards EIA-481/EIA-541.

Go to: www.minicircuits.com/pages/pdfs/tape.pdf



P.O. Box 350166, Brooklyn, New York 11235-0003 (718) 934-4500 Fax (718) 332-4661 For detailed performance specs & shopping online see Mini-Circuits web site



The Design Engineers Search Engine Provides ACTUAL Data Instantly From MINI-CIRCUITS At: www.minicircuits.com

RF/IF MICROWAVE COMPONENTS

Evaluation Board and Circuit

For Pin Connections refer to Data Sheet of the DUT

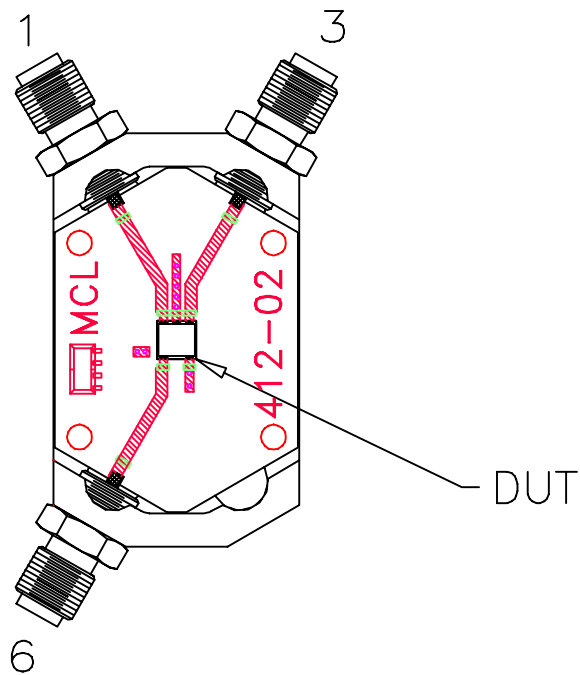

TB-145

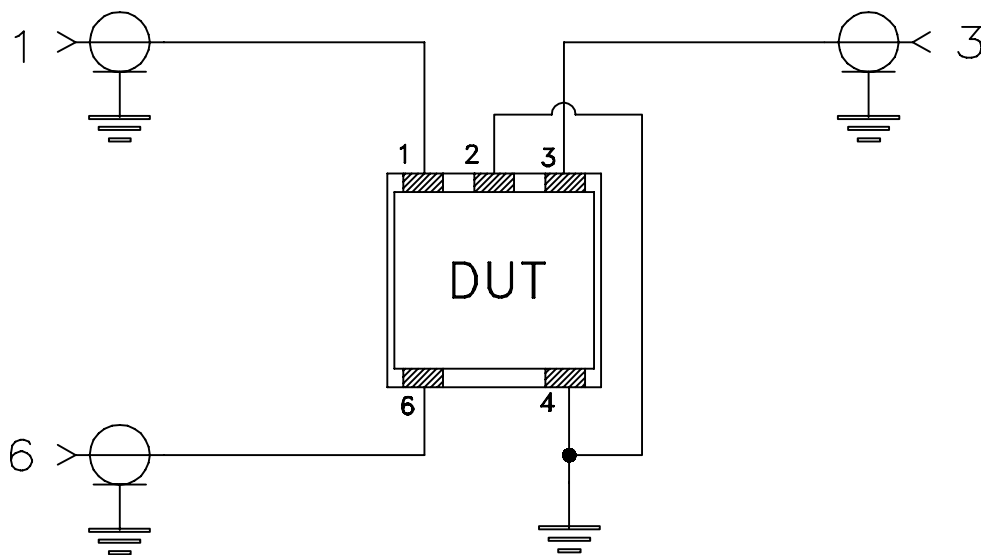

Schematic Diagram

Notes:

1. 50 Ohm SMA Female connectors.
2. PCB Material: Rogers RO4350B or its equivalent, Dielectric Constant=3.5, Thickness=.020"

 **Mini-Circuits®**

All Mini-Circuits products are manufactured under exacting quality assurance and control standards, and are capable of meeting published specifications after being subjected to any or all of the following physical and environmental test.

Specification	Test/Inspection Condition	Reference/Spec
Operating Temperature	-20° to 85°C Ambient Environment	Individual Model Data Sheet
Storage Temperature	-55° to 100° C Ambient Environment	Individual Model Data Sheet
Humidity	90 to 95% RH, 240 hours, 50°C	MIL-STD-202, Method 103, Condition A, Except 50°C and end-point electrical test done within 12 hours
Thermal Shock	-55° to 100°C, 100 cycles	MIL-STD-202, Method 107, Condition A-3, except +100°C
Solder Reflow Heat	Sn-Pb Eutetic Process: 225°C peak Pb-Free Process 245° - 250°C peak	J-STD-020, Table 4-1, 4-2 and 5-2, Figure 5-1
Solderability	10X Magnification	J-STD-002, 95% Coverage
Vibration (High Frequency)	20g peak, 10-2000 Hz, 12 times in each of three perpendicular directions (total 36)	MIL-STD-202, Method 204, Condition D
Mechanical Shock	50g, 11 ms, 1/2-sine, 18 shocks: 3 each direction, each of 3 axes	MIL-STD-202, Method 213, Condition A
Marking Resistance to Solvents	Isopropyl alcohol + mineral spirits at 25°C; terpene defluxer at 25°C; distilled water + proylene glycol monomethyl ether + monoethanolamine at 63°C to 70°C	MIL-STD-202, Method 215