

# Surface Mount High Pass Filter

## THP-700+

50Ω      700 to 4000 MHz

### The Big Deal

- Small size (0.25" X 0.25" X 0.10")
- Good matching
- Low insertion loss

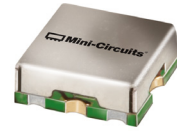

Generic photo used for illustration purposes only  
CASE STYLE: GQ1018

### Product Overview

THP-700+ is a 50Ω high pass filter fabricated using SMT technology. This high pass filter covers from 700 to 4000 MHz. This series of filters are constructed in a tiny package offering dual advantage of superior lumped element filter performance in a space saving SMT package. These models are suitable for mass production without losing flexibility of small volume requirements. It has repeatable performance across lots and consistent performance across temperature.

### Key Features

Feature	Advantages
Low insertion loss	Can be used in high performance applications.
Good rejection	This enables the filter to attenuate spurious signals and reject harmonics for broad band frequency.
Small size, 0.25" X 0.25" X 0.10"	The small surface mount package enables the THP-700+ to be used compact designs.

#### Notes

- A. Performance and quality attributes and conditions not expressly stated in this specification document are intended to be excluded and do not form a part of this specification document.  
B. Electrical specifications and performance data contained in this specification document are based on Mini-Circuit's applicable established test performance criteria and measurement instructions.  
C. The parts covered by this specification document are subject to Mini-Circuits standard limited warranty and terms and conditions (collectively, "Standard Terms"); Purchasers of this part are entitled to the rights and benefits contained therein. For a full statement of the Standard Terms and the exclusive rights and remedies thereunder, please visit Mini-Circuits' website at [www.minicircuits.com/MCLStore/terms.jsp](http://www.minicircuits.com/MCLStore/terms.jsp)



# Surface Mount High Pass Filter

## THP-700+

50Ω 700 to 4000 MHz



Generic photo used for illustration purposes only  
CASE STYLE: GQ1018

### Features

- Low insertion loss
- Good matching
- Small size ( 0.25" X 0.25" 0.10" )

### Electrical Specifications at 25°C

Parameter	F#	Frequency (MHz)	Min.	Typ.	Max.	Unit	
Stop Band	Rejection Loss	DC-F1	DC-395	20	30	-	dB
	VSWR	DC-F1	DC-395	-	20	-	:1
Pass Band	Insertion Loss	F2-F3	700-4000	-	0.5	2.0	dB
	VSWR	F2-F3	700-4000	-	1.2	1.92	:1

### Applications

- Defense system
- Public safety services
- Private and public mobile

### Functional Schematic

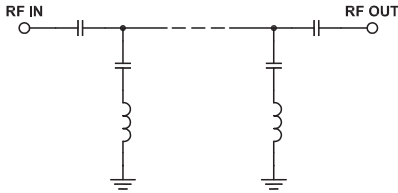

### Typical Frequency Response

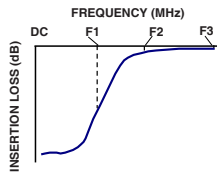

Maximum Ratings	
Operating Temperature	-40°C to 85°C
Storage Temperature	-55°C to 100°C
RF Power Input	0.5 W max.

Permanent damage may occur if any of these limits are exceeded.

### Typical Performance Data at 25°C

Frequency (MHz)	Insertion Loss (dB)	VSWR (:1)
10	55.89	434.30
75	39.09	579.06
100	37.17	579.06
250	39.85	193.02
390	31.23	51.10
395	29.71	48.26
400	28.26	45.72
430	20.46	31.60
450	15.98	23.18
470	12.01	15.67
500	7.05	7.87
530	3.64	3.90
570	1.47	1.97
600	0.88	1.47
700	0.42	1.10
1050	0.26	1.20
1000	0.27	1.19
2000	0.19	1.10
3000	0.20	1.08
4000	0.25	1.12

**+RoHS Compliant**  
The +Suffix identifies RoHS Compliance. See our web site for RoHS Compliance methodologies and qualifications

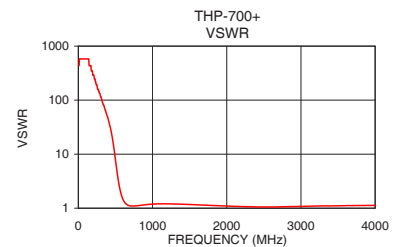
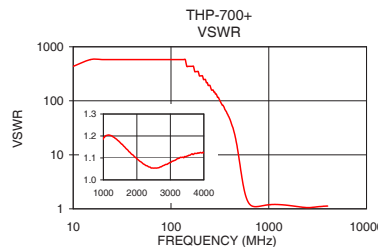
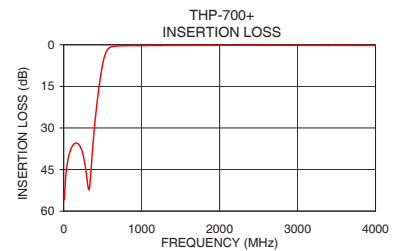
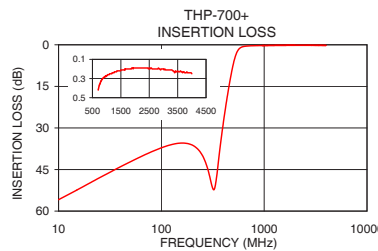

#### Notes

- Performance and quality attributes and conditions not expressly stated in this specification document are intended to be excluded and do not form a part of this specification document.
- Electrical specifications and performance data contained in this specification document are based on Mini-Circuit's applicable established test performance criteria and measurement instructions.
- The parts covered by this specification document are subject to Mini-Circuits standard limited warranty and terms and conditions (collectively, "Standard Terms"); Purchasers of this part are entitled to the rights and benefits contained therein. For a full statement of the Standard Terms and the exclusive rights and remedies thereunder, please visit Mini-Circuits' website at [www.minicircuits.com/MCLStore/terms.jsp](http://www.minicircuits.com/MCLStore/terms.jsp)



## Pad Connections

INPUT	8
OUTPUT	4
GROUND	1, 2, 3, 5, 6, 7

### Demo Board MCL P/N: TB-680 Suggested PCB Layout (PL-372)

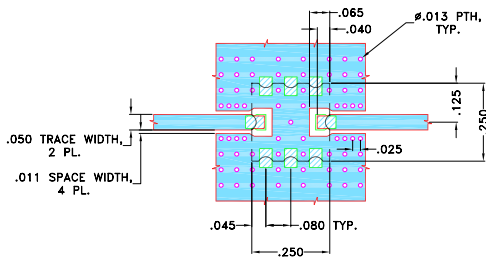

#### NOTES:

- TRACE WIDTH IS SHOWN FOR OAK (OAK-602) WITH DIELECTRIC THICKNESS  $.022 \pm .0015$ ". COPPER: 1/2 OZ. EACH SIDE. FOR OTHER MATERIALS TRACE WIDTH MAY NEED TO BE MODIFIED.
- BOTTOM SIDE OF THE PCB IS CONTINUOUS GROUND PLANE.

DENOTES PCB COPPER LAYOUT WITH SMOBC (SOLDER MASK OVER BARE COPPER)

DENOTES COPPER LAND PATTERN FREE OF SOLDERMASK

## Outline Drawing

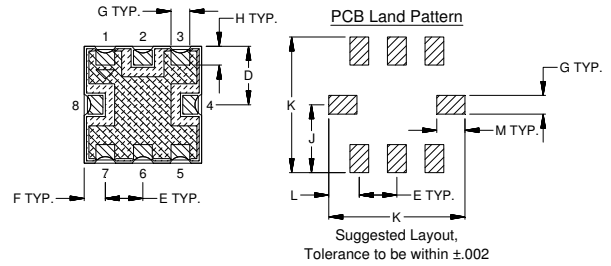
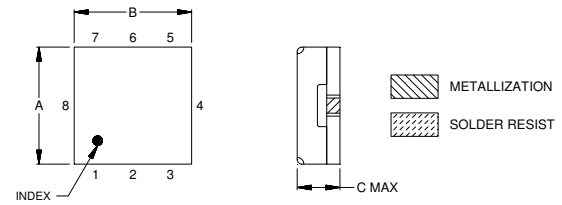

## Outline Dimensions (inch)

A	B	C	D	E	F	G
.25	.25	.10	.125	.080	.045	.040
6.35	6.35	2.54	3.18	2.03	1.14	1.02
H	J	K	L	M	Wt.	
.040	.145	.290	.065	.060	grams	
1.02	3.68	7.37	1.65	1.52	.25	

Note: Please refer to case style drawing for details

#### Notes

- A. Performance and quality attributes and conditions not expressly stated in this specification document are intended to be excluded and do not form a part of this specification document.  
 B. Electrical specifications and performance data contained in this specification document are based on Mini-Circuit's applicable established test performance criteria and measurement instructions.  
 C. The parts covered by this specification document are subject to Mini-Circuits standard limited warranty and terms and conditions (collectively, "Standard Terms"); Purchasers of this part are entitled to the rights and benefits contained therein. For a full statement of the Standard Terms and the exclusive rights and remedies thereunder, please visit Mini-Circuits' website at [www.minicircuits.com/MCLStore/terms.jsp](http://www.minicircuits.com/MCLStore/terms.jsp)

## Typical Performance Data

FREQ.  (MHz)	INSERTION LOSS			INPUT RETURN LOSS			OUTPUT RETURN LOSS		
	(dB)			(dB)			(dB)		
	@-40°C	@+25°C	@+85°C	@-40°C	@+25°C	@+85°C	@-40°C	@+25°C	@+85°C
10.00	55.94	55.89	55.88	0.04	0.04	0.04	0.04	0.04	0.04
20.00	49.92	49.91	49.93	0.03	0.03	0.03	0.03	0.03	0.03
40.00	44.03	44.01	44.01	0.03	0.03	0.03	0.03	0.03	0.03
65.00	40.17	40.15	40.11	0.02	0.03	0.03	0.02	0.03	0.03
130.00	35.97	35.88	35.81	0.02	0.03	0.03	0.02	0.03	0.03
160.00	35.52	35.45	35.38	0.03	0.04	0.04	0.02	0.04	0.04
225.00	37.48	37.56	37.54	0.05	0.07	0.08	0.04	0.06	0.07
255.00	40.28	40.44	40.50	0.07	0.10	0.11	0.06	0.08	0.09
285.00	45.03	45.32	45.46	0.10	0.13	0.14	0.09	0.11	0.12
310.00	50.47	50.81	51.03	0.13	0.16	0.18	0.12	0.14	0.15
325.00	52.04	52.28	52.36	0.15	0.19	0.20	0.14	0.16	0.17
345.00	47.59	47.51	47.36	0.18	0.22	0.24	0.16	0.19	0.21
365.00	39.94	39.78	39.63	0.22	0.27	0.29	0.20	0.23	0.25
390.00	31.38	31.23	31.12	0.28	0.34	0.37	0.26	0.30	0.32
395.00	29.86	29.71	29.61	0.30	0.36	0.39	0.28	0.32	0.34
410.00	25.63	25.49	25.40	0.36	0.43	0.46	0.33	0.38	0.40
430.00	20.61	20.46	20.38	0.47	0.55	0.59	0.43	0.50	0.53
445.00	17.21	17.05	16.98	0.59	0.69	0.74	0.56	0.63	0.67
455.00	15.10	14.94	14.87	0.71	0.82	0.88	0.67	0.76	0.81
470.00	12.16	12.01	11.92	0.96	1.11	1.19	0.92	1.04	1.10
475.00	11.24	11.09	11.01	1.08	1.23	1.32	1.03	1.16	1.23
480.00	10.35	10.21	10.13	1.21	1.38	1.47	1.16	1.30	1.39
490.00	8.67	8.55	8.47	1.54	1.74	1.86	1.49	1.66	1.77
510.00	5.80	5.73	5.66	2.57	2.84	3.02	2.51	2.75	2.91
525.00	4.12	4.09	4.04	3.73	4.06	4.30	3.67	3.97	4.19
535.00	3.23	3.24	3.20	4.72	5.07	5.37	4.65	4.98	5.26
540.00	2.86	2.88	2.85	5.27	5.65	5.96	5.21	5.55	5.85
555.00	1.98	2.03	2.03	7.14	7.56	7.94	7.08	7.47	7.84
570.00	1.40	1.47	1.48	9.28	9.73	10.18	9.22	9.64	10.08
590.00	0.94	1.02	1.05	12.37	12.84	13.37	12.35	12.79	13.33
650.00	0.45	0.54	0.58	21.57	21.86	22.55	21.89	22.29	23.08
700.00	0.34	0.42	0.46	26.47	26.09	26.66	27.27	27.21	27.96
775.00	0.27	0.35	0.38	27.06	26.15	26.16	27.62	26.78	26.85
800.00	0.25	0.33	0.36	26.36	25.49	25.34	26.75	25.91	25.80
820.00	0.24	0.32	0.35	25.64	24.86	24.61	25.92	25.15	24.92
850.00	0.23	0.30	0.34	24.59	23.96	23.60	24.74	24.12	23.76
920.00	0.21	0.28	0.32	22.58	22.37	21.79	22.61	22.42	21.82
1000.00	0.20	0.27	0.30	21.22	21.26	20.49	21.25	21.30	20.50
1100.00	0.18	0.25	0.29	20.80	20.73	19.79	20.84	20.75	19.78
1260.00	0.16	0.24	0.27	21.64	20.85	19.79	21.67	20.84	19.74
1350.00	0.14	0.23	0.26	22.25	21.25	20.19	22.34	21.23	20.14
1490.00	0.13	0.22	0.25	23.14	22.04	21.01	23.35	22.08	21.00
1550.00	0.12	0.21	0.25	23.86	22.49	21.47	24.14	22.58	21.49
1640.00	0.11	0.20	0.24	25.20	23.16	22.19	25.34	23.24	22.20
1770.00	0.10	0.20	0.24	26.21	24.44	23.61	26.22	24.42	23.52
1870.00	0.10	0.20	0.24	26.08	25.33	24.70	26.12	25.18	24.55
1920.00	0.10	0.19	0.23	26.50	25.91	25.38	26.46	25.70	25.17
2050.00	0.09	0.19	0.23	28.58	27.30	27.07	27.92	26.83	26.63
2300.00	0.09	0.19	0.23	30.15	30.08	30.45	29.57	29.54	30.04
2400.00	0.09	0.19	0.24	30.14	31.05	31.63	29.49	30.58	31.41
2575.00	0.08	0.19	0.24	29.70	31.66	32.05	29.32	31.98	33.00
2800.00	0.08	0.20	0.25	30.68	29.95	29.80	30.99	31.92	32.04
3000.00	0.08	0.20	0.27	30.09	28.38	27.84	31.43	30.86	30.10
3200.00	0.08	0.21	0.28	29.28	26.81	26.32	31.78	29.40	28.46
3300.00	0.08	0.21	0.28	28.57	26.22	25.76	30.80	28.72	27.86
3400.00	0.09	0.24	0.29	28.08	26.37	25.63	29.15	27.51	27.21
3525.00	0.08	0.23	0.30	27.03	25.73	25.49	28.70	27.49	27.06
3700.00	0.09	0.23	0.32	25.29	25.14	25.28	26.74	26.90	26.52
3900.00	0.09	0.24	0.32	22.39	24.61	25.32	23.22	26.34	26.86
4000.00	0.11	0.25	0.33	21.56	24.73	25.63	22.02	26.00	27.13

## Typical Performance Data

FREQ.  (MHz)	GROUP DELAY		
	(nsec)		
	@-40°C	@+25°C	@+85°C
700	0.93	0.91	0.90
715	0.86	0.85	0.84
730	0.81	0.79	0.79
745	0.76	0.74	0.74
760	0.71	0.70	0.69
775	0.67	0.66	0.65
790	0.64	0.62	0.62
805	0.60	0.59	0.59
820	0.58	0.56	0.56
835	0.55	0.54	0.53
850	0.52	0.51	0.51
865	0.50	0.49	0.48
880	0.48	0.47	0.46
895	0.46	0.45	0.44
910	0.44	0.43	0.42
925	0.42	0.41	0.41
940	0.41	0.40	0.39
955	0.39	0.38	0.38
970	0.38	0.37	0.37
985	0.37	0.36	0.35
1000	0.35	0.34	0.34
1040	0.33	0.32	0.32
1080	0.31	0.30	0.29
1120	0.29	0.27	0.27
1160	0.27	0.26	0.25
1200	0.25	0.24	0.24
1240	0.24	0.23	0.22
1280	0.23	0.21	0.21
1320	0.22	0.20	0.20
1360	0.21	0.19	0.19
1400	0.20	0.19	0.18
1440	0.19	0.18	0.17
1480	0.18	0.17	0.17
1520	0.17	0.16	0.16
1560	0.17	0.16	0.15
1600	0.16	0.15	0.15
1680	0.15	0.14	0.14
1720	0.15	0.14	0.13
1760	0.15	0.13	0.13
1840	0.14	0.13	0.12
1880	0.13	0.12	0.12
2000	0.12	0.11	0.11
2100	0.12	0.11	0.10
2200	0.12	0.10	0.10
2225	0.11	0.10	0.10
2300	0.11	0.10	0.10
2400	0.11	0.10	0.09
2500	0.10	0.09	0.09
2600	0.10	0.09	0.09
2700	0.10	0.09	0.08
2800	0.10	0.09	0.08
2900	0.09	0.08	0.08
3000	0.09	0.08	0.08
3300	0.09	0.08	0.07
3400	0.09	0.08	0.07
3500	0.09	0.07	0.07
3600	0.09	0.07	0.07
3800	0.08	0.07	0.07
3900	0.08	0.07	0.07
4000	0.08	0.07	0.07

## Typical Performance Curves

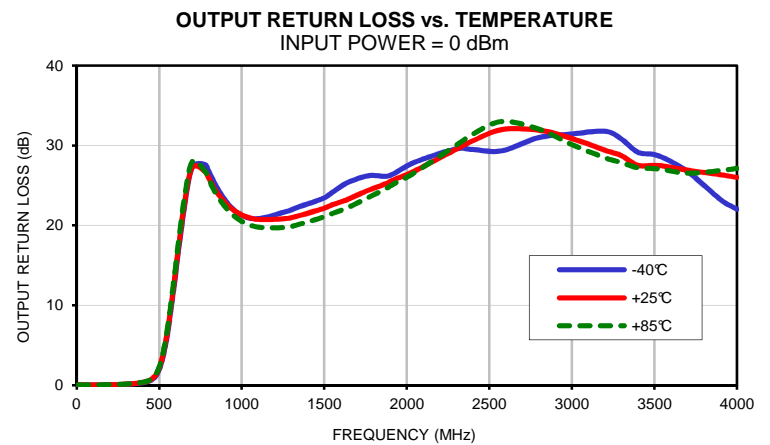
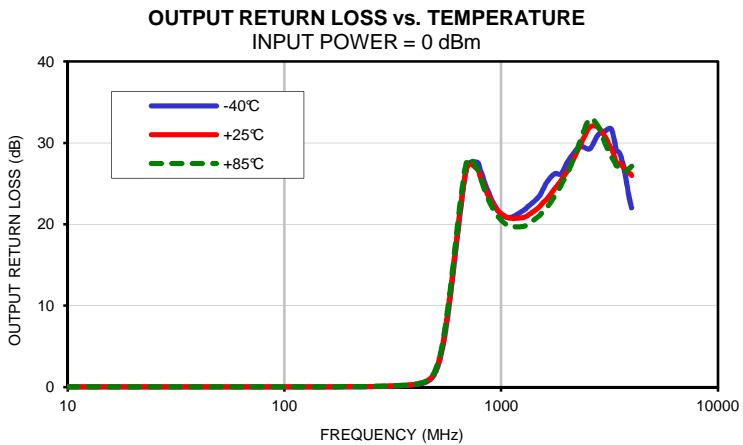
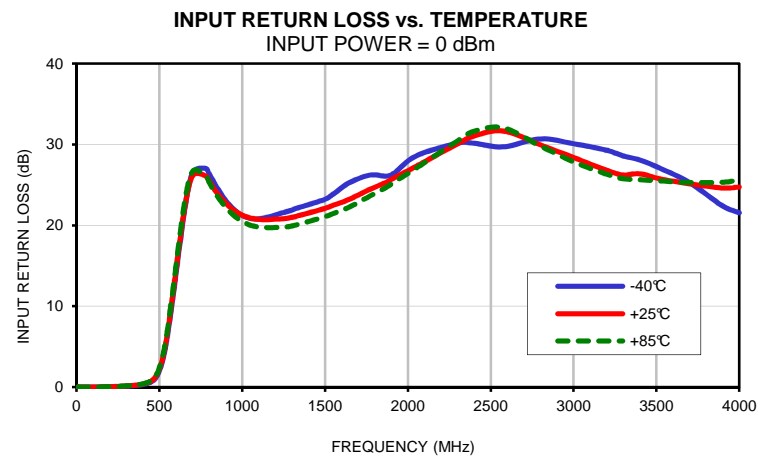
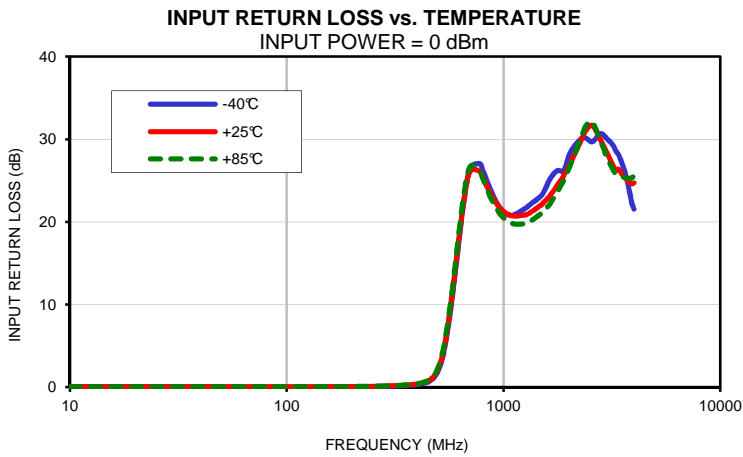
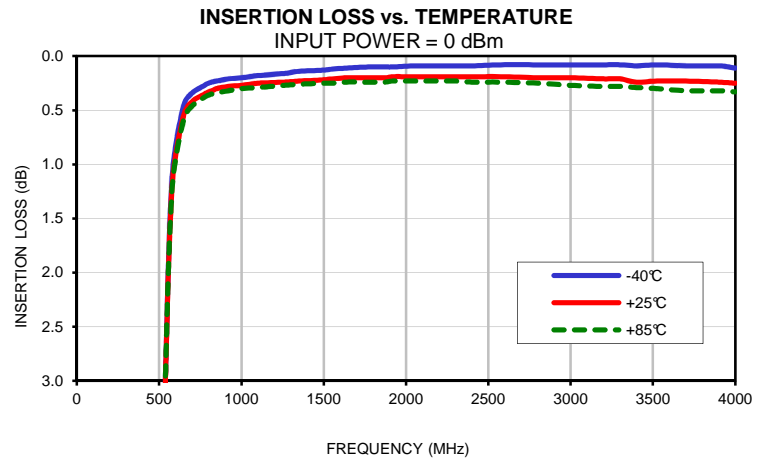
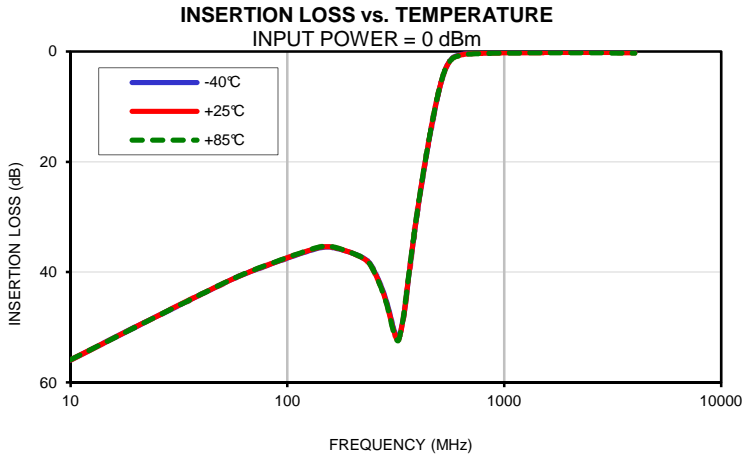

## Typical Performance Curves

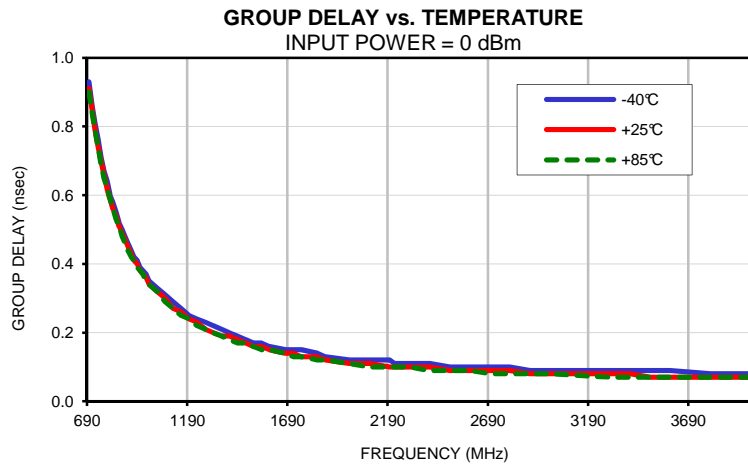

# Case Style

# GQ

## Outline Dimensions

GQ1018

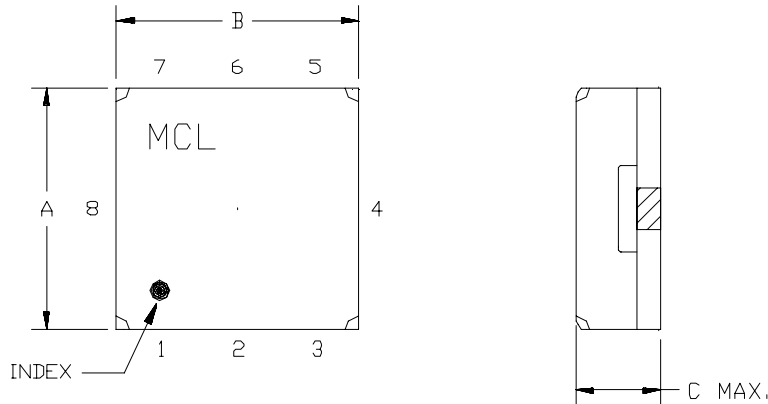

## PCB Land Pattern

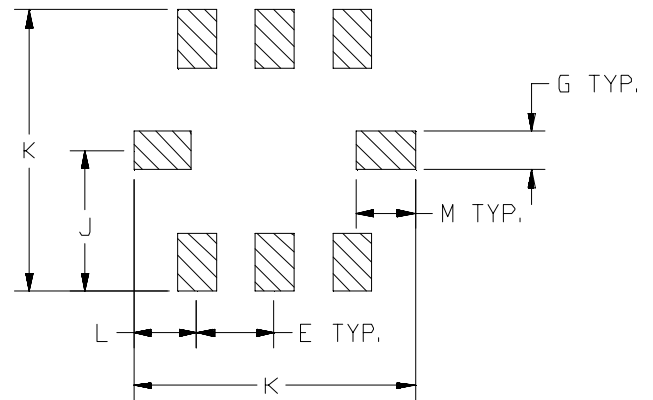
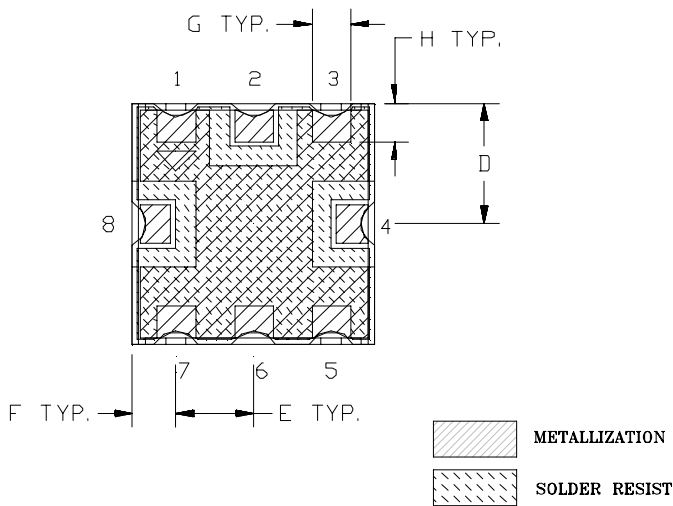

Suggested Layout,  
Tolerance to be within  $\pm 0.002$

CASE #	A	B	C	D	E	F	G	H	J	K	L	M	WT. GRAMS
GQ1018	.25 (6.35)	.25 (6.35)	.10 (2.54)	.125 (3.18)	.080 (2.03)	.045 (1.14)	.040 (1.02)	.040 (1.02)	.145 (3.68)	.290 (7.37)	.065 (1.65)	.060 (1.52)	.25

Dimensions are in inches (mm). Tolerances: 2 Pl.  $\pm 0.01$ "; 3 Pl.  $\pm 0.005$ "

### Notes:

- Case material: Nickel-Silver alloy.
- Base: Printed wiring laminate.
- Termination finish:
  - For RoHS Case Styles: 3-5  $\mu$  inch Gold over 120-240  $\mu$  inch Nickel plate.
  - For RoHS-5 Case Styles: Tin-Lead plate.



P.O. Box 350166, Brooklyn, New York 11235-0003 (718) 934-4500 Fax (718) 332-4661 For detailed performance specs & shopping online see Mini-Circuits web site



The Design Engineers Search Engine Provides ACTUAL Data Instantly From MINI-CIRCUITS At: [www.minicircuits.com](http://www.minicircuits.com)

RF/IF MICROWAVE COMPONENTS



# Tape & Reel Packaging TR-F78

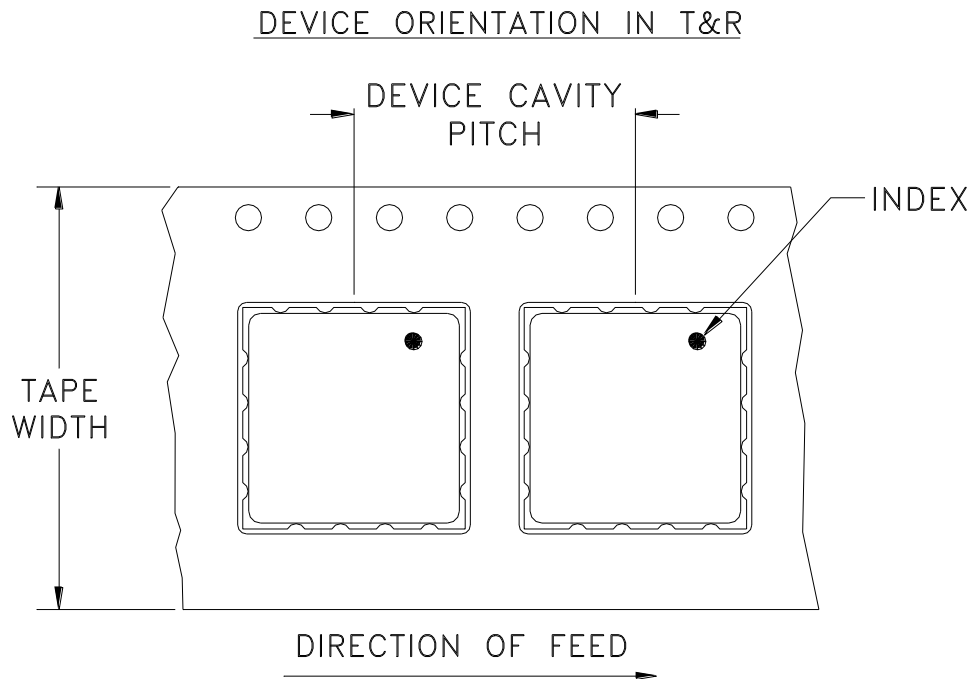

Tape Width, mm	Device Cavity Pitch, mm	Reel Size, inches	Devices per Reel see note
16	12	7	10
			20
			50
			100
			200
		13	500, 1000

Note: Please consult individual model data sheet to determine device per reel availability.

Mini-Circuits carrier tape materials provide protection from ESD (Electro-Static Discharge) during handling and transportation. Tapes are static dissipative and comply with industry standards EIA-481/EIA-541.

Go to: [www.minicircuits.com/pages/pdfs/tape.pdf](http://www.minicircuits.com/pages/pdfs/tape.pdf)



INTERNET <http://www.minicircuits.com>

P.O. Box 350166, Brooklyn, New York 11235-0003 (718) 934-4500 Fax (718) 332-4661

Distribution Centers NORTH AMERICA 800-654-7949 • 417-335-5935 • Fax 417-335-5945 • EUROPE 44-1252-832600 • Fax 44-1252-837010

Mini-Circuits ISO 9001 & ISO 14001 Certified

THIRD ANGLE PROJECTION

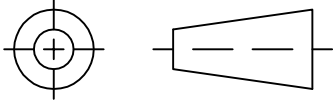

REVISIONS

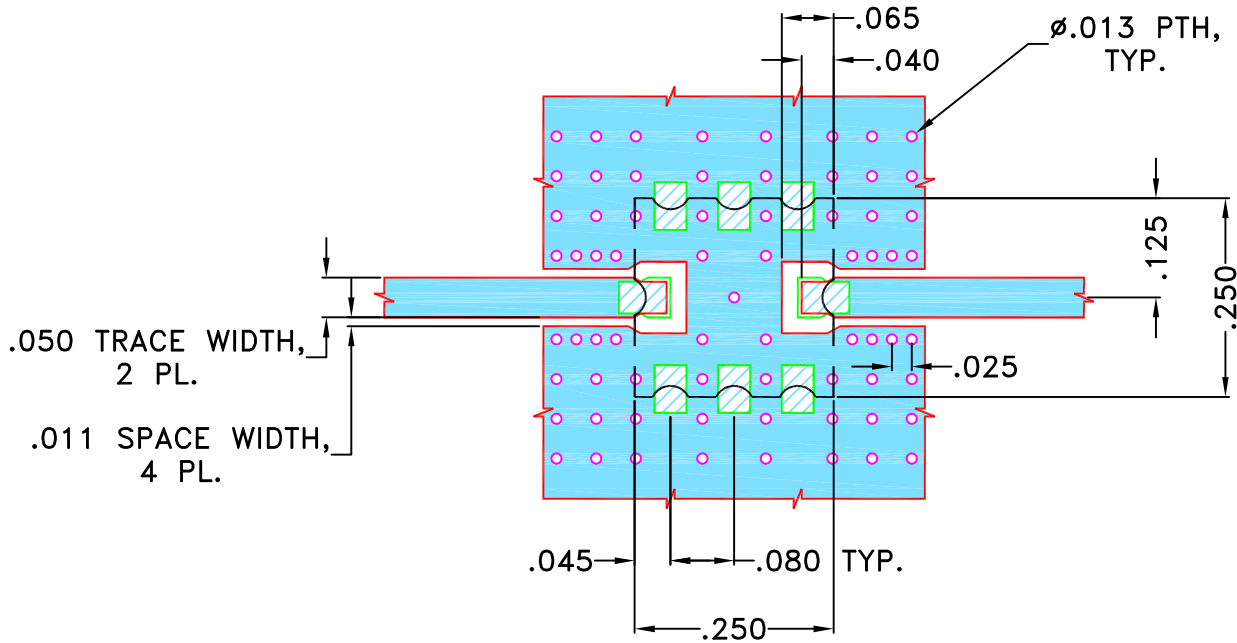

REV	ECN No.	DESCRIPTION	DATE	DR	AUTH
OR	M135450	NEW RELEASE	JUN 12	DDR	KG

SUGGESTED MOUNTING CONFIGURATION FOR GQ1018 CASE STYLE "08FL04" PIN CODE



NOTES:

1. TRACE WIDTH IS SHOWN FOR OAK (OAK-602) WITH DIELECTRIC THICKNESS .022"±.0015". COPPER: 1/2 OZ. EACH SIDE. FOR OTHER MATERIALS TRACE WIDTH MAY NEED TO BE MODIFIED.
2. BOTTOM SIDE OF THE PCB IS CONTINUOUS GROUND PLANE.

-  DENOTES PCB COPPER LAYOUT WITH SMOBC (SOLDER MASK OVER BARE COPPER)
-  DENOTES COPPER LAND PATTERN FREE OF SOLDERMASK

UNLESS OTHERWISE SPECIFIED	INITIALS	DATE
DIMENSIONS ARE IN INCHES	DRAWN	DDR 07 JUN 12
TOLERANCES ON:	CHECKED	MD 07 JUN 12
2 PL DECIMALS ±	APPROVED	GM 07 JUN 12
3 PL DECIMALS ± .005"		
ANGLES ±		
FRACTIONS ±		

 **Mini-Circuits®** 13 Neptune Avenue  
Brooklyn NY 11235

PL, 08FL04, GQ1018, THP,  
TB-680+, 50 Ohm

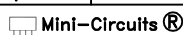
 Mini-Circuits®  
THIS DOCUMENT AND ITS CONTENTS ARE THE PROPERTY OF MINI-CIRCUITS. EXCEPT FOR USE EXPRESSLY GRANTED, IN WRITING, TO ITS VENDORS, VENDEE AND THE UNITED STATES GOVERNMENT, MINI-CIRCUITS RESERVES ALL PROPRIETARY DESIGN, USE, MANUFACTURING AND REPRODUCTION RIGHTS THERETO. THESE CONTENTS SHALL NOT BE USED, DUPLICATED OR DISCLOSED TO ANY OUTSIDE PARTY, IN WHOLE OR IN PART, WITHOUT WRITTEN PERMISSION OF MINI-CIRCUITS.

ASHEETA1.DWG REV:A DATE:01/12/95

SIZE	CODE IDENT	DRAWING NO:	REV:
A	15542	98-PL-372	OR
FILE:	98PL372	SCALE:	SHEET:
		4:1	1 OF 1

# Evaluation Board and Circuit

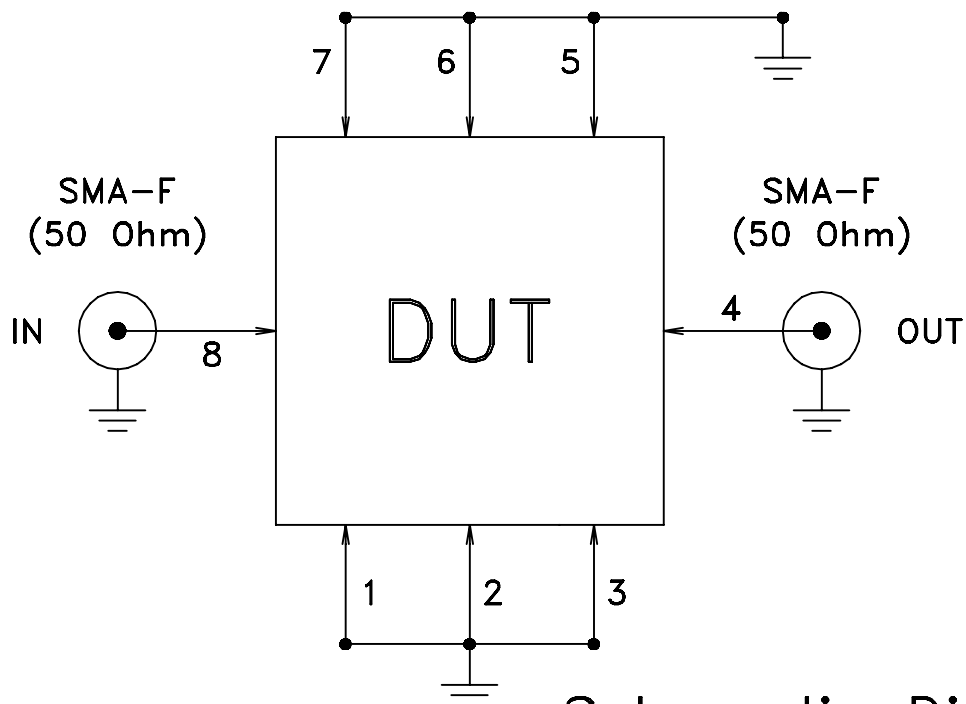
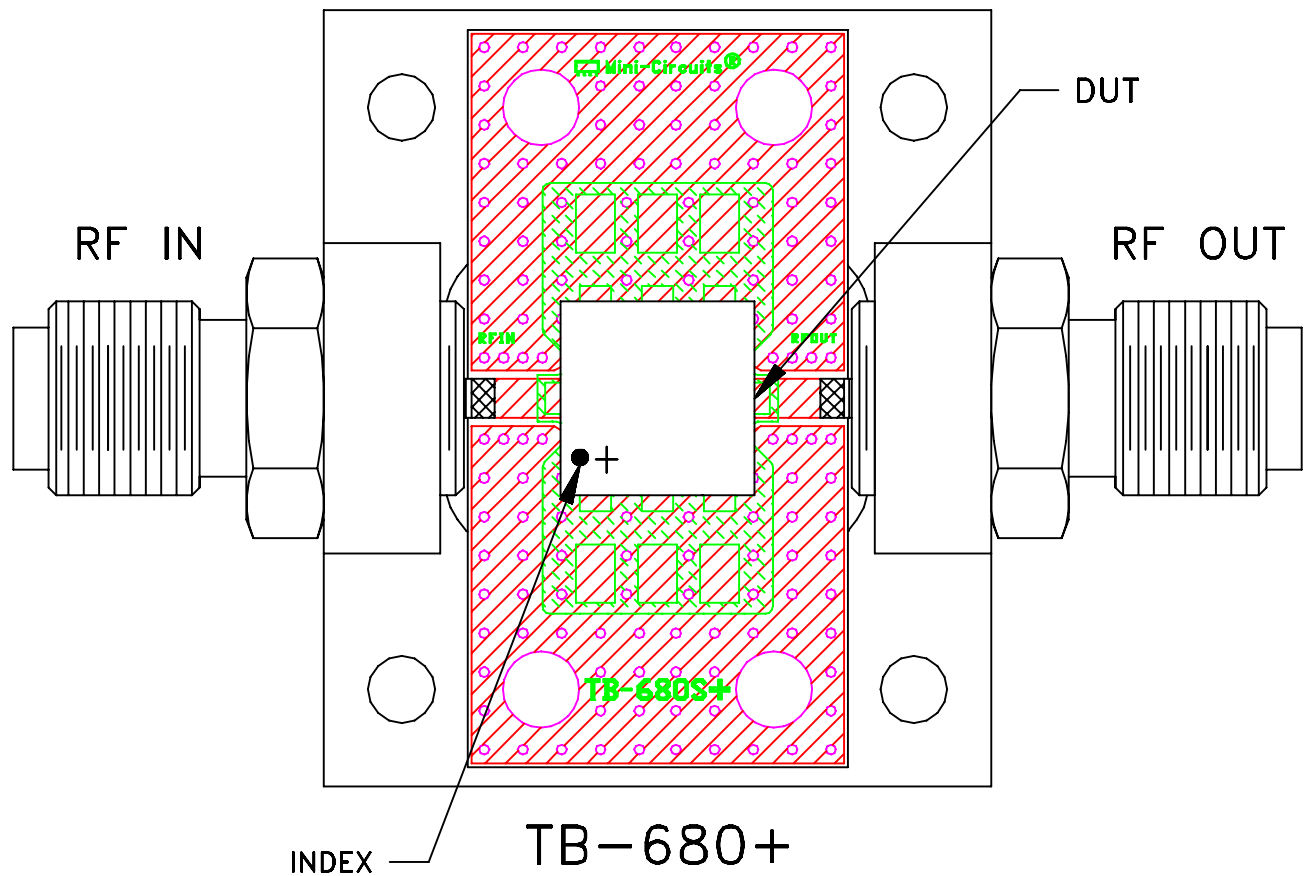

Schematic Diagram

**Notes:**

1. 50 Ohm SMA Female connectors.
2. PCB Material: OAK-602 OR Equivalent  
Dielectric Constant=2.50±.04, Thickness=.022 inch.

 **Mini-Circuits®**

All Mini-Circuits products are manufactured under exacting quality assurance and control standards, and are capable of meeting published specifications after being subjected to any or all of the following physical and environmental test.

Specification	Test/Inspection Condition	Reference/Spec
Operating Temperature	-40° to 85° C Ambient Environment	Individual Model Data Sheet
Storage Temperature	-55° to 100° C Ambient Environment	Individual Model Data Sheet
HAST	130°C, 85% RH, 96 hours	JESD22-A110
Humidity	90 to 95% RH, 240 hours, 50°C	MIL-STD-202, Method 103, Condition A, Except 50°C and end-point electrical test done within 12 hours
Thermal Shock	-55° to 100°C, 100 cycles	MIL-STD-202, Method 107, Condition A-3, except +100°C
Solder Reflow Heat	Sn-Pb Eutectic Process: 225°C peak Pb-Free Process, 245°C peak	J-STD-020, Table 4-1, 4-2 and 5-2, Figure 5-1
Solderability	10X Magnification	J-STD-002, Para 4.2.5, Test S, 95% Coverage
Vibration (High Frequency)	20g peak, 20-2000 Hz, 4 times in each of three axes (total 12)	MIL-STD-883, Method 2007.3, Condition A
Mechanical Shock	50g, 11 ms, 1/2-sine, 18 shocks: 3 each direction, each of 3 axes	MIL-STD-202, Method 213, Condition A
Marking Resistance to Solvents	Isopropyl alcohol + mineral spirits at 25°C; terpene defluxer at 25°C; distilled water + proylene glycol monomethyl ether + monoethanolamine at 63°C to 70°C	MIL-STD-202, Method 215