

50Ω 4.5 to 3000 MHz

The Big Deal

- Wideband, 4.5 to 3000 MHz
- Low insertion loss, 1.5 dB typ. up to 2 GHz
- Good amplitude unbalance, ± 0.4 dB typ.
- Low phase unbalance, 4° typ.
- Excellent common mode rejection, 26 dB typ.



CASE STYLE: GU2939

Product Overview

Mini-Circuits' TTC1-33W-1+ is a tiny surface-mount transmission line core and wire transformer covering a very wide frequency range from 4.5 to 3000 MHz. The transformer provides low insertion loss. It achieves low phase and amplitude unbalance and excellent common mode rejection performance. Featuring core and wire construction on 5 terminal carrier, the unit measures 0.10 x 0.06 x 0.07", accommodating dense circuit board layouts.

Key Features

Feature	Advantages
Wideband, 4.5 to 3000 MHz	Very wide frequency range covers bandwidth requirements for many broadband applications.
Low insertion loss, 1.5 dB typ.	TTC1-33W-1+ provides excellent signal transmission from input to output with consistent performance across its entire frequency range.
Excellent common mode rejection, 26 dB typ.	Provides good IP2, IP3.
Small footprint (0.10 x 0.06 x 0.07")	Accommodates tight space requirements for dense PCB layouts.

Surface Mount RF Transformer

50Ω 4.5 to 3000 MHz

TTC1-33W-1+

Features

- wide bandwidth 4.5 to 3000 MHz
- balanced transmission line
- excellent CMRR
- aqueous washable

Applications

- balanced to unbalanced transformation
- wideband push-pull amplifiers
- PCS/DCS
- MMDS

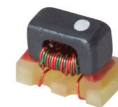

Generic photo used for illustration purposes only

CASE STYLE: GU2939

+RoHS Compliant

The +Suffix identifies RoHS Compliance. See our web site for RoHS Compliance methodologies and qualifications



Available Tape and Reel
at no extra cost

Reel Size	Devices/Reel
7"	20, 50, 100, 200, 500, 1000, 2000

Electrical Specifications at 25°C

Parameter	Frequency (MHz)	Min.	Typ.	Max.	Unit
Impedance Ratio			1		
Frequency Range		4.5		3000	MHz
Average Insertion Loss (above 0.3 dB midband loss)	50-1000	—	0.7	1.0	dB
	10-2000	—	1.5	2.0	
	4.5-3000	—	2.6	3.3	
Phase Unbalance (±)	50-1000	—	2	6	Degree
	10-2000	—	4	8	
Amplitude Unbalance	50-1000	—	0.4	0.9	dB
	10-2000	—	0.8	1.2	
	4.5-3000	—	1.0	1.6	
Common Mode Rejection	10-2000	20	26	—	dB
	4.5-3000	17	23	—	

Maximum Ratings

Parameter	Ratings
Operating Temperature	-40°C to 85°C
Storage Temperature	-55°C to 100°C
RF Power	0.5W

Permanent damage may occur if any of these limits are exceeded.

Pin Connections

Function	Pin Number
PRIMARY DOT	1
PRIMARY	4
SECONDARY DOT	2
SECONDARY	3
NOT USED	5

Config. G

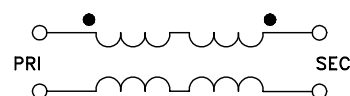

TTC1-33W-1+

Outline Drawing

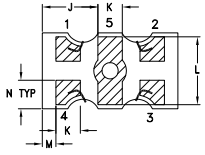
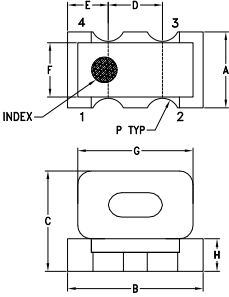

Outline Dimensions (inch/mm)

A	B	C	D	E	F	G	H	J	K	
.056	.100	.074	.040	.030	.040	.085	.024	.041	.018	
1.42	2.54	1.88	1.02	0.76	1.02	2.16	0.61	1.04	0.46	
L	M	N	P	Q	R	S	T			wt
.050	.010	.021	.013	.080	0.013	.018	0.014			grams
1.27	0.25	0.53	0.33	2.03	0.33	0.46	0.36			0.04

PCB Land Pattern

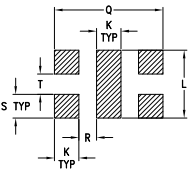

Suggested Layout
Tolerance to be within ±.002

Demo Board MCL P/N: TB-1111+ Suggested PCB Layout (PL-657)

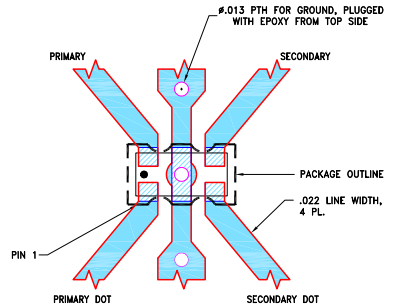

- NOTES:**
 1. TRACE WIDTH IS SHOWN FOR ROGERS RO4350B WITH DIELECTRIC THICKNESS .010±.001". COPPER: 1/2 OZ. EACH SIDE. FOR OTHER MATERIALS TRACE WIDTH MAY NEED TO BE MODIFIED.
 2. BOTTOM SIDE OF THE PCB IS CONTINUOUS GROUND PLANE.

 ■ DENOTES PCB COPPER LAYOUT WITH SMOBC (SOLDER MASK OVER BARE COPPER).
 ■ DENOTES COPPER LAND PATTERN FREE OF SOLDER MASK.

Typical Performance Data

Frequency (MHz)	Insertion Loss (dB)	Input R. Loss (dB)	Amplitude Unbalance (dB)	Phase Unbalance (Deg.)	CMRR (dB)
5	0.23	37.58	0.46	1.26	30.84
10	0.24	39.79	0.43	0.68	31.87
50	0.29	35.34	0.42	0.00	32.43
100	0.35	31.36	0.39	0.25	32.84
500	0.53	23.06	0.24	1.66	33.96
1000	0.76	18.73	0.10	2.93	31.62
1500	0.98	16.78	0.49	2.71	28.65
2000	1.18	21.54	0.78	0.79	26.81
2600	1.73	14.82	0.71	3.56	25.83
3000	2.75	8.40	0.33	7.07	23.80

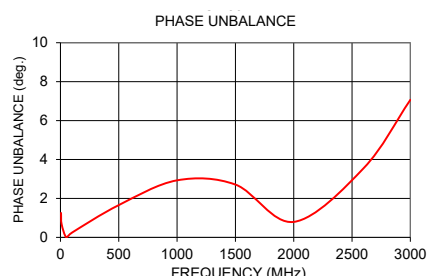
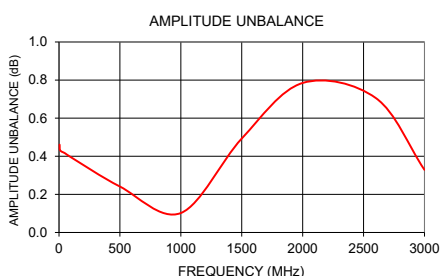
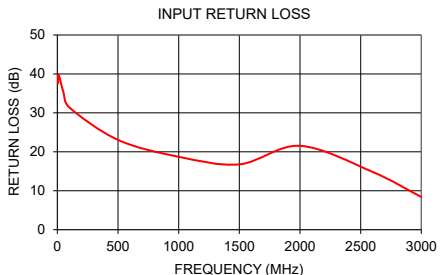

Additional Notes

- A. Performance and quality attributes and conditions not expressly stated in this specification document are intended to be excluded and do not form a part of this specification document.
- B. Electrical specifications and performance data contained in this specification document are based on Mini-Circuits' applicable established test performance criteria and measurement instructions.
- C. The parts covered by this specification document are subject to Mini-Circuits standard limited warranty and terms and conditions (collectively, "Standard Terms"); Purchasers of this part are entitled to the rights and benefits contained therein. For a full statement of the Standard Terms and the exclusive rights and remedies thereunder, please visit Mini-Circuits' website at www.minicircuits.com/MCLStore/terms.jsp



Typical Performance Data

FREQUENCY (MHz)	AVERAGE INSERTION LOSS (dB)	INPUT RETURN LOSS (dB)	AMPLITUDE UNBALANCE (dB)	PHASE UNBALANCE (deg.)	CMRR (dB)
3	0.24	35.99	0.51	1.90	29.47
5	0.23	37.58	0.46	1.26	30.84
7	0.23	38.78	0.44	0.95	31.45
10	0.24	39.79	0.43	0.68	31.87
20	0.25	39.95	0.42	0.32	32.33
30	0.27	38.24	0.42	0.16	32.33
40	0.28	36.72	0.42	0.07	32.38
50	0.29	35.34	0.42	0.00	32.43
60	0.31	34.34	0.41	0.06	32.48
80	0.33	32.78	0.41	0.16	32.53
100	0.35	31.36	0.39	0.25	32.84
150	0.42	28.49	0.40	0.42	32.59
200	0.42	27.72	0.38	0.60	32.97
300	0.45	25.92	0.34	0.95	33.52
400	0.50	24.11	0.29	1.30	33.92
500	0.53	23.06	0.24	1.66	33.96
550	0.54	22.81	0.21	1.81	34.06
600	0.55	22.20	0.18	1.97	33.96
650	0.58	21.68	0.15	2.11	33.87
700	0.62	21.05	0.12	2.31	33.48
800	0.66	20.40	0.05	2.56	32.96
900	0.70	19.62	0.03	2.77	32.32
950	0.73	19.22	0.07	2.84	32.00
1000	0.76	18.73	0.10	2.93	31.62
1100	0.81	18.24	0.18	3.04	30.91
1150	0.82	18.02	0.23	3.03	30.63
1200	0.85	17.64	0.26	3.04	30.35
1250	0.87	17.35	0.30	3.03	29.97
1300	0.91	17.12	0.34	3.03	29.62
1400	0.95	16.93	0.42	2.88	29.19
1500	0.98	16.78	0.49	2.71	28.65
1600	1.03	16.87	0.56	2.46	28.20
1700	1.07	17.36	0.63	2.16	27.73
1800	1.09	18.08	0.69	1.77	27.39
1900	1.14	19.36	0.75	1.33	27.04
2000	1.18	21.54	0.78	0.79	26.81
2100	1.21	24.91	0.81	0.17	26.60
2150	1.26	26.80	0.81	0.14	26.58
2200	1.29	28.92	0.83	0.51	26.36
2400	1.45	21.72	0.80	1.97	26.19
2600	1.73	14.82	0.71	3.56	25.83
2800	2.19	10.88	0.55	5.24	25.08
2900	2.45	9.51	0.44	6.13	24.54
3000	2.75	8.40	0.33	7.07	23.80
3050	2.90	7.90	0.25	7.58	23.37
3100	3.06	7.46	0.19	8.06	22.94
3150	3.20	7.06	0.11	8.54	22.51
3200	3.35	6.74	0.03	9.02	22.06
3250	3.50	6.44	0.07	9.46	21.64
3300	3.67	6.17	0.17	9.97	21.13
3350	3.79	5.93	0.25	10.45	20.67
3400	3.94	5.70	0.37	10.85	20.23
3450	4.03	5.53	0.46	11.27	19.82
3500	4.17	5.38	0.58	11.55	19.46

Typical Performance Data

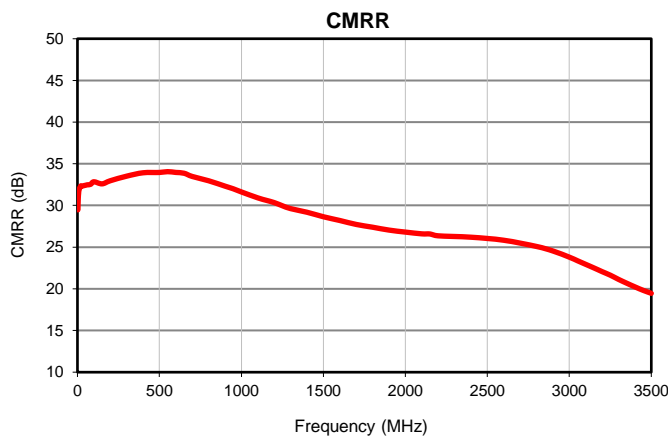
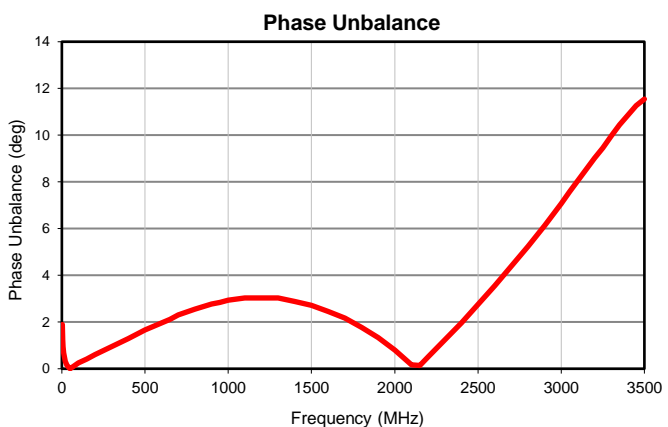
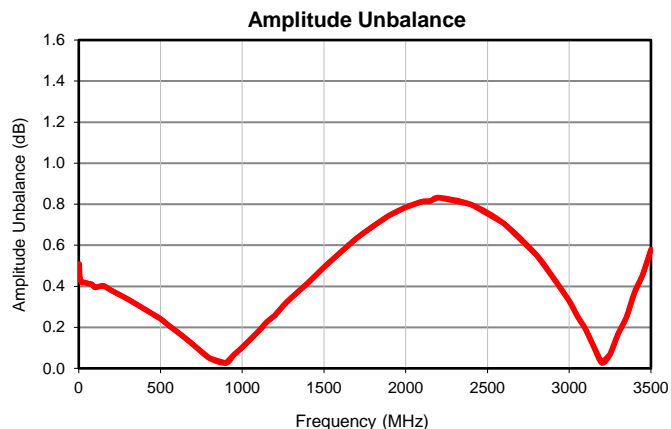
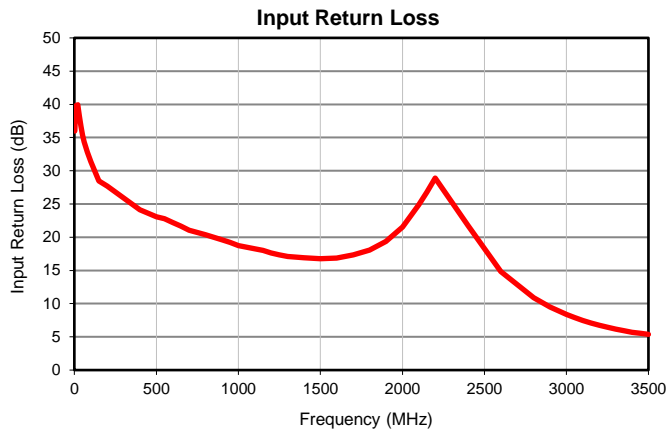
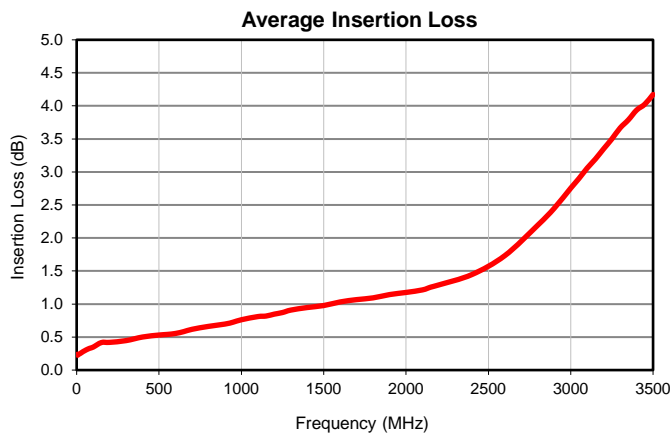

Case Style

GU

Outline Dimensions

GU2939

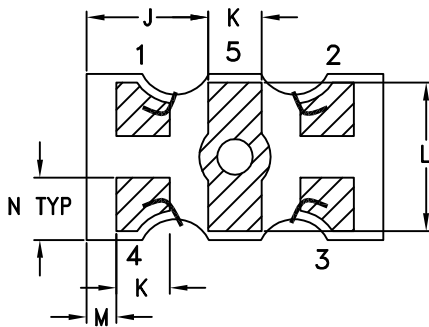
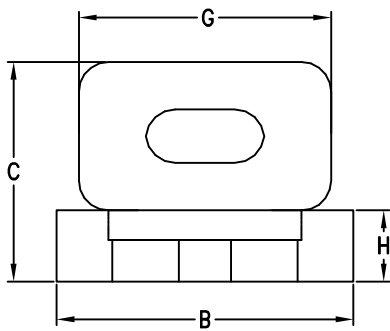
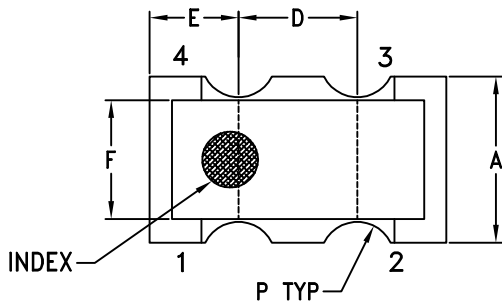

PCB Land Pattern

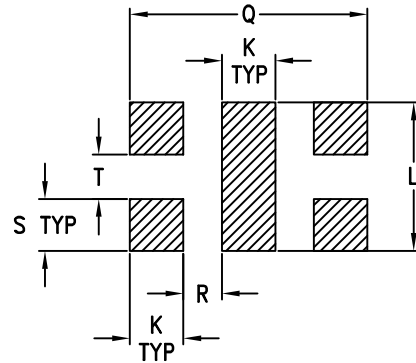

Suggested Layout

Tolerance to be within ± 0.002

Wires shown are for reference only.

CASE #	A	B	C	D	E	F	G	H	J	K	L	M	N	P
GU2939	.056 (1.42)	.100 (2.54)	.074 (1.88)	.040 (1.02)	.030 (0.76)	.040 (1.02)	.085 (2.16)	.024 (0.61)	.041 (1.04)	.018 (0.46)	.050 (1.27)	.010 (0.25)	.021 (0.53)	.013 (0.33)

CASE #	Q	R	S	T	WT, GRAM
GU2939	.080 (2.03)	.013 (0.33)	.018 (0.46)	.014 (0.36)	.040

Dimensions are in inches (mm). Tolerances: 2 Pl. ± 0.01 ; 3 Pl. ± 0.005

Notes:

1. Case material: Plastic Base.
2. Termination finish: Gold Plating.

Mini-Circuits®
ISO 9001 ISO 14001 CERTIFIED

ALL NEW
minicircuits.com

P.O. Box 350166, Brooklyn, New York 11235-0003 (718) 934-4500 Fax (718) 332-4661 For detailed performance specs & shopping online see Mini-Circuits web site



The Design Engineers Search Engine Provides ACTUAL Data Instantly From MINI-CIRCUITS At: www.minicircuits.com

RF/IF MICROWAVE COMPONENTS

Tape & Reel Packaging TR-F74

DEVICE ORIENTATION IN T&R



ILLUSTRATION 1

Applicable Case Styles

GE0805C-1
GE0805C-1AP
JV1210C-1
GU2939



ILLUSTRATION 2

Applicable Case Styles

JV1210C
JV1210C-2
JV1210C-3
JV1210C-4
JV1210C-5
JV1210C-6
JV1210C-11

ILLUSTRATION 3

Applicable Case Styles

JC0603C-8
JC0603C-9
JV1210C-7
JV1210C-8
JV1210C-9
JV1210C-10
JV1210C-13
GE0805C-13
GE0805C-19
GE0805C-20

Tape Width, mm	Device Cavity Pitch, mm	Real Size, inches	Devices per Reel	
8	4	7	Small quantity standards (see note)	20
				50
				100
				200
				500
				1000
			Standard	2000
				4000

Note: Small reel availability varies by model. Refer to pricing and availability on individual model dashboard.

Mini-Circuits carrier tape materials provide protection from ESD (Electro-Static Discharge) during handling and transportation. Tapes are static dissipative and comply with industry standards EIA-481/EIA-541.

Go to: www.minicircuits.com/pages/pdfs/tape.pdf



Distribution Centers NORTH AMERICA 800-654-7949 • 417-335-5935 • Fax 417-335-5945 • EUROPE 44-1252-832600 • Fax 44-1252-837010

Mini-Circuits ISO 9001 & ISO 14001 Certified

INTERNET <http://www.minicircuits.com>

P.O. Box 350166, Brooklyn, New York 11235-0003 (718) 934-4500 Fax (718) 332-4661

THIRD ANGLE PROJECTION

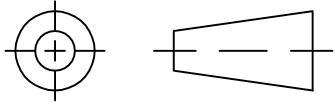

REVISIONS

REV	ECN No.	DESCRIPTION	DATE	DR	AUTH
OR	ECO-001192	NEW RELEASE	12/26/19	ITG	IL

SUGGESTED MOUNTING CONFIGURATION
FOR GU2939 CASE STYLE

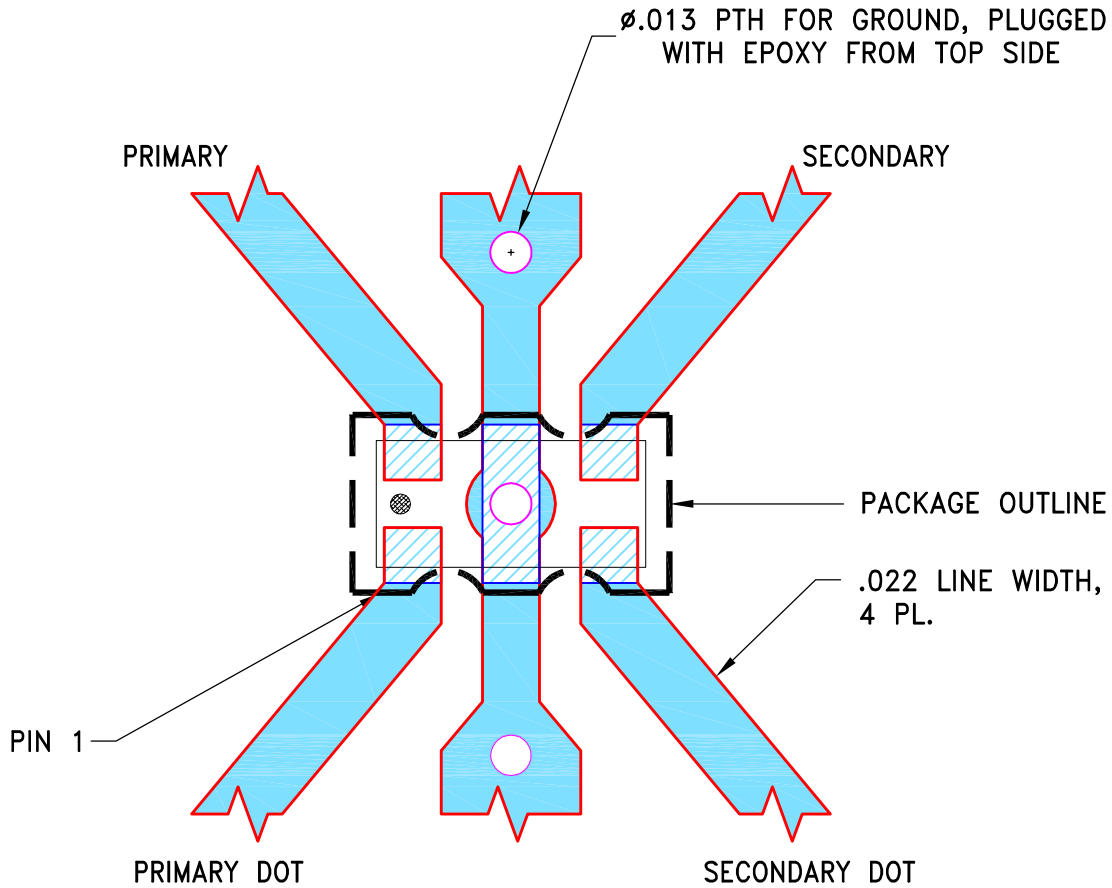

NOTES:

- TRACE WIDTH IS SHOWN FOR ROGERS R04350B WITH DIELECTRIC THICKNESS .010"±.001".
COPPER: 1/2 OZ. EACH SIDE. FOR OTHER MATERIALS TRACE WIDTH MAY NEED TO BE MODIFIED.
- BOTTOM SIDE OF THE PCB IS CONTINUOUS GROUND PLANE.



DENOTES PCB COPPER LAYOUT WITH SMOBC (SOLDER MASK OVER BARE COPPER).



DENOTES COPPER LAND PATTERN FREE OF SOLDER MASK.

UNLESS OTHERWISE SPECIFIED	INITIALS	DATE
DIMENSIONS ARE IN INCHES	DRAWN ITG	12/24/19
TOLERANCES ON:	CHECKED GF	12/24/19
2 PL DECIMALS ±	APPROVED IL	12/26/19
3 PL DECIMALS ± .005		
ANGLES ±		
FRACTIONS ±		



Mini-Circuits®

13 Neptune Avenue
Brooklyn NY 11235

PL, GU2939, TB-1111+

Mini-Circuits®
THIS DOCUMENT AND ITS CONTENTS ARE THE PROPERTY OF MINI-CIRCUITS. EXCEPT FOR USE EXPRESSLY GRANTED, IN WRITING, TO ITS VENDORS, VENDEE AND THE UNITED STATES GOVERNMENT, MINI-CIRCUITS RESERVES ALL PROPRIETARY DESIGN, USE, MANUFACTURING AND REPRODUCTION RIGHTS THERETO. THESE CONTENTS SHALL NOT BE USED, DUPLICATED OR DISCLOSED TO ANY OUTSIDE PARTY, IN WHOLE OR IN PART, WITHOUT WRITTEN PERMISSION OF MINI-CIRCUITS.

ASHEETA1.DWG REV:A DATE:01/12/95

SIZE A	CODE IDENT 15542	DRAWING NO: 98-PL-657	REV: OR
FILE: 98PL657	SCALE: 16:1	SHEET: 1 OF 1	

All Mini-Circuits products are manufactured under exacting quality assurance and control standards, and are capable of meeting published specifications after being subjected to any or all of the following physical and environmental test.

Specification	Test/Inspection Condition	Reference/Spec
Operating Temperature	-40° to 85°C Ambient Environment	Individual Model Data Sheet
Storage Temperature	-55° to 100° C Ambient Environment	Individual Model Data Sheet
Humidity	90 to 95% RH, 240 hours, 50°C	MIL-STD-202, Method 103, Condition A, Except 50°C and end-point electrical test done within 12 hours
Thermal Shock	-55° to 100°C, 100 cycles	MIL-STD-202, Method 107, Condition A-3, except +100°C
Solder Reflow Heat	Sn-Pb Eutetic Process: 225°C peak Pb-Free Process 245° - 250°C peak	J-STD-020, Table 4-1, 4-2 and 5-2, Figure 5-1
Solderability	10X Magnification	J-STD-002, 95% Coverage
Vibration (High Frequency)	20g peak, 10-2000 Hz, 12 times in each of three perpendicular directions (total 36)	MIL-STD-202, Method 204, Condition D
Mechanical Shock	50g, 11 ms, 1/2-sine, 18 shocks: 3 each direction, each of 3 axes	MIL-STD-202, Method 213, Condition A
Marking Resistance to Solvents	Isopropyl alcohol + mineral spirits at 25°C; terpene defluxer at 25°C; distilled water + proylene glycol monomethyl ether + monoethanolamine at 63°C to 70°C	MIL-STD-202, Method 215