



MMIC SURFACE MOUNT

Fixed Attenuator

XAT-10+

50Ω DC to 45 GHz 1.9 W 10 dB

THE BIG DEAL

- Wideband, DC to 45 GHz
- High Power Handling, 1.9 W
- Excellent Return Loss, Typ. 15 dB
- 1x1 mm, 2-Lead QFN-Style Package

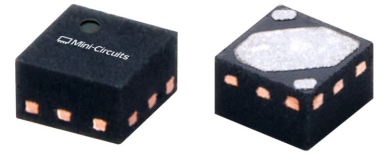

Generic photo used for illustration purposes only

APPLICATIONS

- Test & Measurement Equipment
- Satellite Communications
- Radar, EW, and ECM Defense Systems
- Telecom Infrastructure
- 5G sub-6 GHz and mmW

FUNCTIONAL DIAGRAM (TOP VIEW)

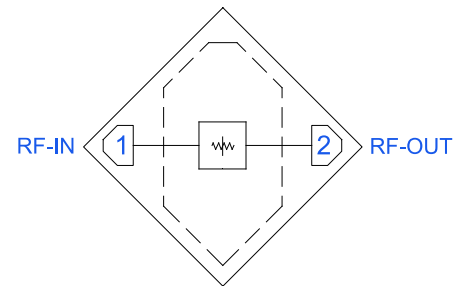

PRODUCT OVERVIEW

The XAT-10+ sets a new benchmark in RF component miniaturization as the smallest MMIC attenuator by virtue of its 2-lead, 1x1 mm QFN package, which enables unprecedented space savings in next-generation high-density PCB designs. Fabricated on a robust GaAs semiconductor process, its bidirectional, fully absorptive design delivers exceptional passband flatness, maintains excellent return loss throughout the entire band, and delivers consistent and repeatable performance from DC to 45 GHz. With up to 1.9 W input power handling, the XAT-10+ is perfectly suited for space-constrained, high frequency applications, including Test & Measurement, Satellite Communications, Radar Systems, EW/ECM Defense Systems, Telecom Infrastructure, and 5G networks.

KEY FEATURES

Features	Advantages
Wideband Operation, DC to 45 GHz	Flat attenuation response from DC to 45 GHz supports a wide array of applications including Test & Measurement Equipment, Satellite Communications, Radar, EW, ECM Defense Systems, Telecom, & 5G applications.
Excellent Return Loss	Excellent Return Loss across the entire passband minimizes reflections and enables flexibility to implement anywhere within wideband signal chains.
1x1 mm 2-Lead QFN-Style Package	Ultra-compact footprint saves space in dense layouts while providing low inductance and excellent thermal contact to the PCB. Innovative industry-leading packaging allows for ease of assembly in high-volume manufacturing processes.

REV. A
ECO-029664
XAT-10+
MCL NY
260521





MMIC SURFACE MOUNT

Fixed Attenuator

XAT-10+

50Ω DC to 45 GHz 1.9 W 10 dB

ELECTRICAL SPECIFICATIONS^{1,2} AT +25 °C, 50Ω, UNLESS NOTED OTHERWISE

Parameter	Condition (GHz)	Min.	Typ.	Max.	Units
Frequency Range		DC		45	GHz
Attenuation	0.01-10	9.6	10.2	10.6	dB
	10-20	9.7	10.2	10.7	
	20-30	9.6	10.1	10.6	
	30-40	9.1	9.8	10.7	
	40-45		9.6		
Input Return Loss	0.01-10		15		dB
	10-20		15		
	20-30		15		
	30-40		13		
	40-45		15		
Output Return Loss	0.01-10		15		dB
	10-20		15		
	20-30		15		
	30-40		13		
	40-45		15		

1. Tested on Mini-Circuits Characterization Test/Evaluation Board TB-XAT-10C+. See Figure 2. Board loss de-embedded to the device.

2. Bi-directional RF-IN and RF-OUT ports can be interchanged.



TYPICAL PERFORMANCE GRAPHS

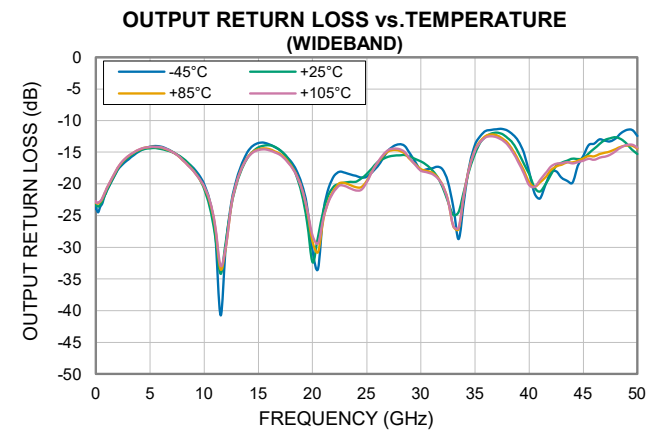
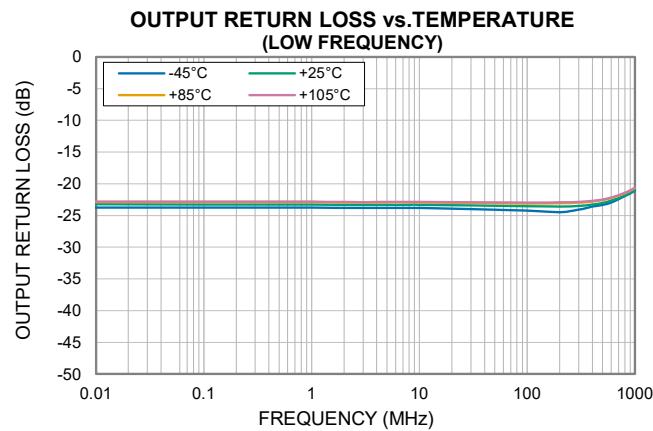
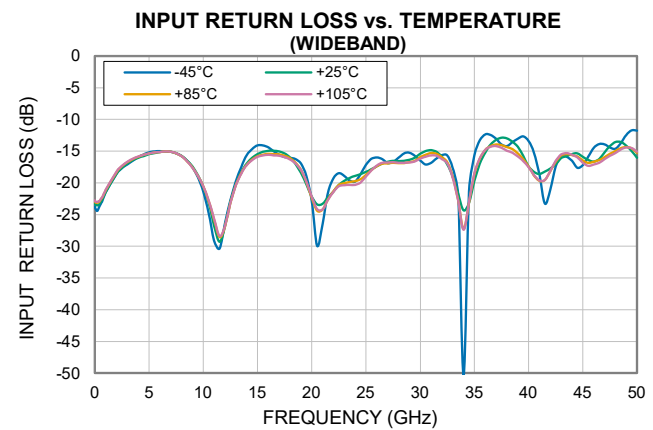
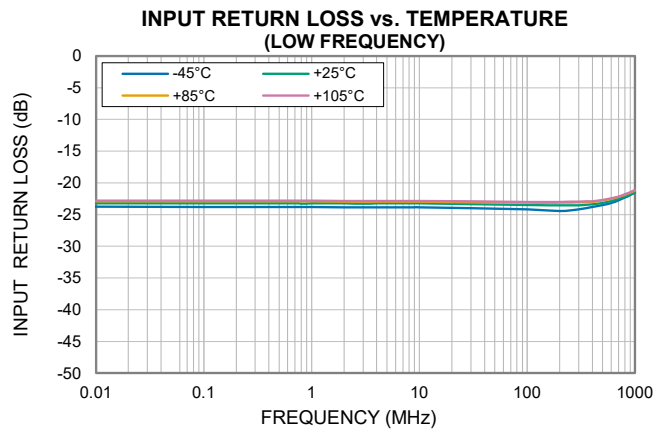
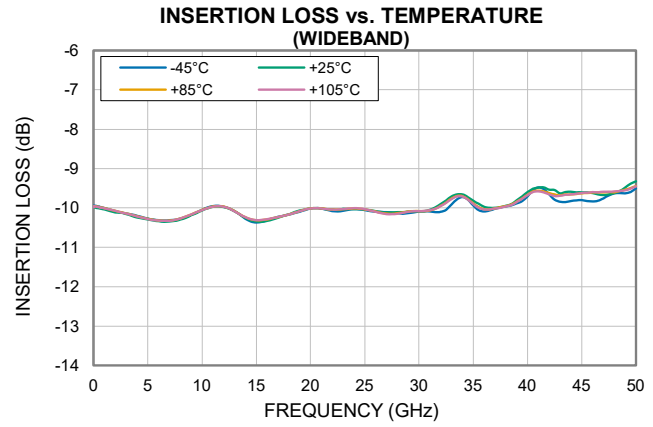
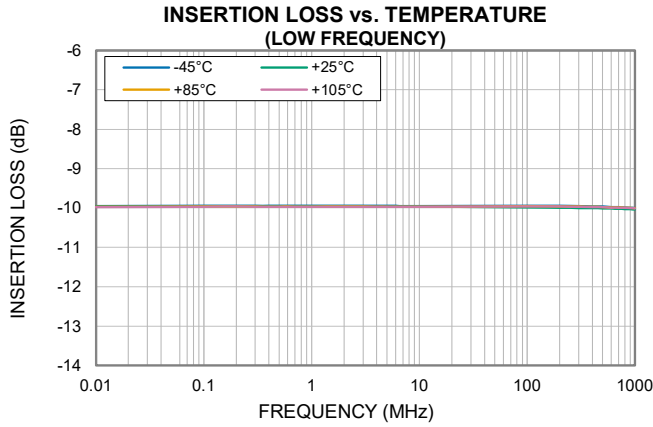



MMIC SURFACE MOUNT

Fixed Attenuator

XAT-10+

50Ω DC to 45 GHz 1.9 W 10 dB

ABSOLUTE MAXIMUM RATINGS³

Parameter	Ratings
Operating Temperature	-45 °C to +105 °C
Storage Temperature	-65 °C to +150 °C
RF Input Power ⁴	1.9 W

3. Permanent damage may occur if any of these limits are exceeded. Maximum ratings are not intended for continuous normal operation.

4. Power derated to 1 W at +105 °C.

ESD RATING

	Class	Voltage Range	Reference Standard
HBM	1C	> 1000 V	ANSI/ESDA/JEDEC JS-001-2023
CDM	C3	> 1000 V	ANSI/ESDA/JEDEC JS-002-2022



ESD HANDLING PRECAUTION: This device is designed to be Class 1C for HBM. Static charges may easily produce potentials higher than this with improper handling and can discharge into DUT and damage it. As a preventive measure Industry standard ESD handling precautions should be used at all times to protect the device from ESD damage.

MSL RATING

Moisture Sensitivity: MSL1 in accordance with IPC/JEDEC J-STD-020E /JEDEC J-STD-033C





FUNCTIONAL DIAGRAM (TOP VIEW)

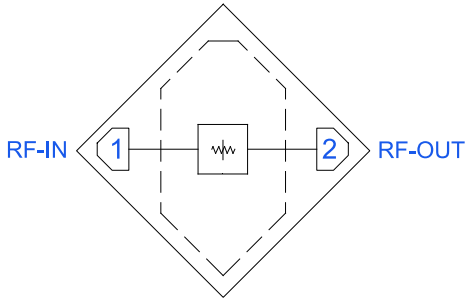

Figure 1. XAT-10+ Functional Diagram

PAD DESCRIPTION

Function	Pad #	Description (Refer to Figure 2)
RF-IN	1	RF-IN Pad connects to RF Input port.
RF-OUT	2	RF-OUT Pad connects to RF Output port.
GND	Paddle	Connects to ground.

CHARACTERIZATION TEST BOARD

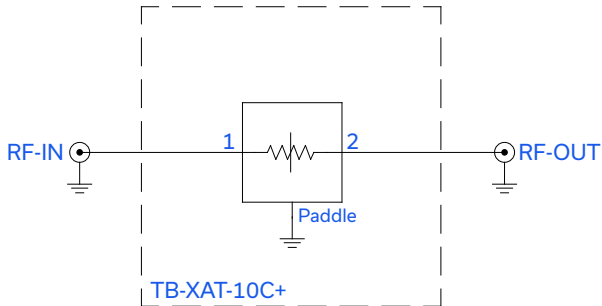

Figure 2. XAT-10+ Characterization and Application Circuit.

Electrical Parameters and Conditions

Insertion Loss and Return Loss are measured using N5247B PNA-X microwave network analyzer.

Conditions:

1. Insertion Loss and Return Loss: $P_{IN} = -5 \text{ dBm}$



CASE STYLE DRAWING

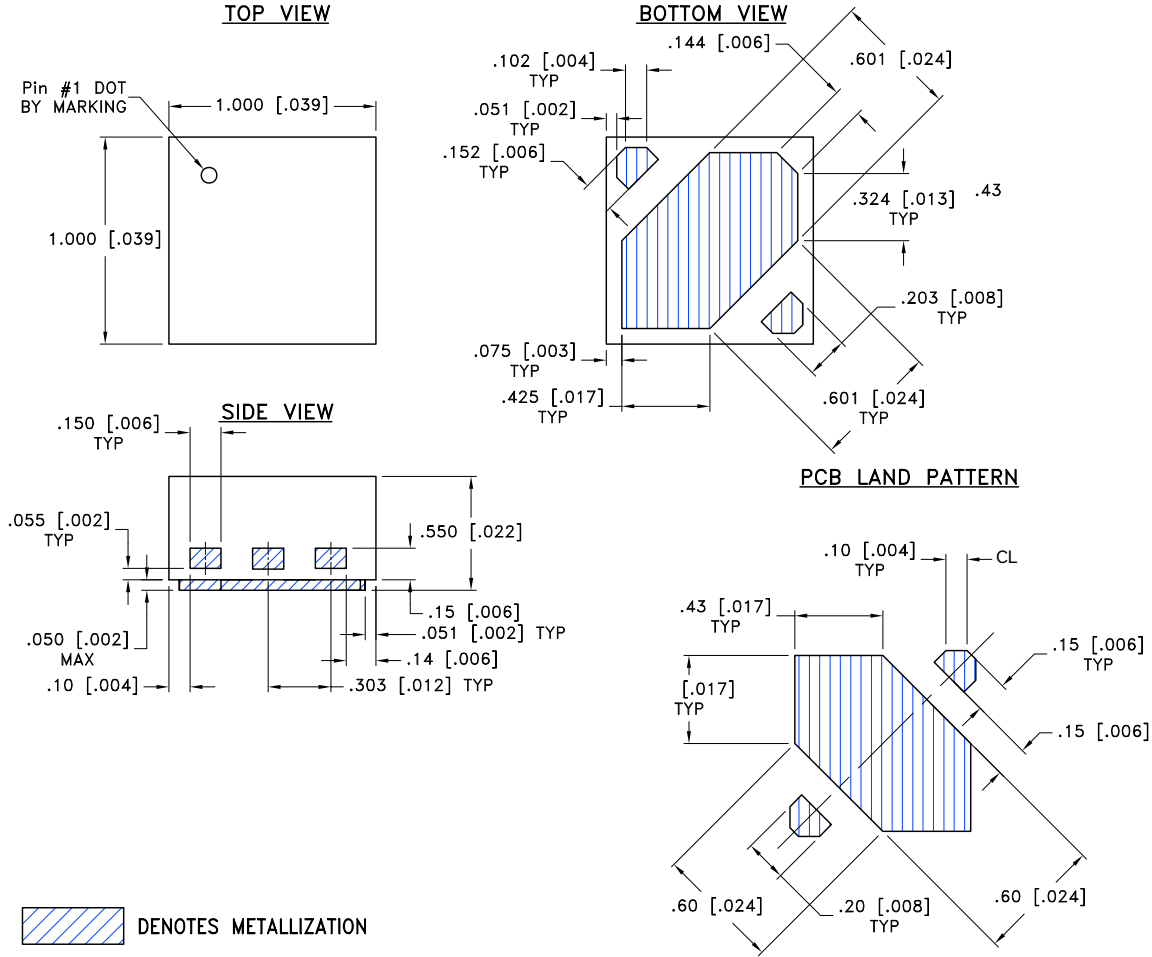

SUGGESTED PCB LAND PATTERN
Tolerance to be within ±.05

Weight: 0.002 grams
Dimensions are in mm [inches]. Tolerances: 3 Pl.±0.050 mm

PRODUCT MARKING

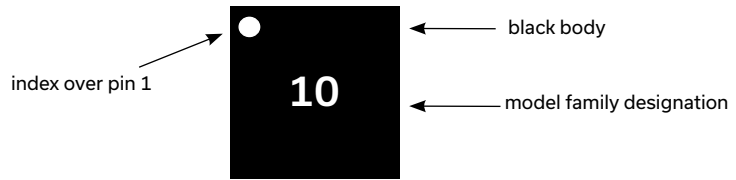

Marking may contain other features or characters for internal lot control



MMIC SURFACE MOUNT

Fixed Attenuator

XAT-10+

50Ω DC to 45 GHz 1.9 W 10 dB

ADDITIONAL DETAILED INFORMATION IS AVAILABLE ON OUR DASHBOARD [CLICK HERE](#)

Performance Data	Data Graphs S-Parameter (S2P Files) Data Set (.zip file)
Case Style	BBS3016 Plastic package, exposed paddle, lead finish: Matte-Tin
RoHS Status	Compliant
Tape & Reel Standard quantities available on reel	F66 7" reels with 20, 50, 100, 200, 500, 1000, 2000, or 3000 devices
Suggested Layout for PCB Design	PL-861
Evaluation Board	TB-XAT-10C+ Gerber File
Environmental Ratings	ENV08T1

Notes

- A. Performance and quality attributes and conditions not expressly stated in this specification document are intended to be excluded and do not form a part of this specification document.
- B. Electrical specifications and performance data contained in this specification document are based on Mini-Circuits' applicable established test performance criteria and measurement instructions.
- C. The parts covered by this specification document are subject to Mini-Circuits' standard limited warranty and terms and conditions (collectively, "Standard Terms"; Purchasers of this part are entitled to the rights and benefits contained therein. For a full statement of the standard terms and the exclusive rights and remedies thereunder, please visit Mini-Circuits' website at www.minicircuits.com/terms/viewterm.html



Typical Performance Data

Definitions:

Input Return Loss = -S11 (dB)

Attenuation = -S21 (dB)

Output Return Loss = -S22 (dB)

FREQ	Attenuation				Input Return Loss				Output Return Loss			
	-45°C	+25°C	+85°C	+105°C	-45°C	+25°C	+85°C	+105°C	-45°C	+25°C	+85°C	+105°C
(MHz)	(dB)	(dB)	(dB)	(dB)	(dB)	(dB)	(dB)	(dB)	(dB)	(dB)	(dB)	(dB)
0.009	9.96	9.95	9.97	9.98	23.82	23.21	22.92	22.85	23.76	23.22	22.90	22.80
0.5	9.95	9.96	9.97	9.97	23.82	23.25	22.94	22.83	23.77	23.28	22.90	22.82
1	9.95	9.96	9.97	9.97	23.82	23.25	22.94	22.83	23.78	23.29	22.92	22.83
5	9.95	9.96	9.97	9.97	23.85	23.25	22.97	22.86	23.81	23.31	22.95	22.86
10	9.95	9.96	9.97	9.97	23.85	23.26	22.97	22.87	23.80	23.32	22.95	22.85
100	9.94	9.99	9.96	9.96	24.20	23.51	23.15	23.02	24.24	23.53	23.11	22.98
200	9.94	9.99	9.96	9.97	24.45	23.58	23.15	23.01	24.48	23.59	23.08	22.93
400	9.96	10.00	9.97	9.98	23.81	23.40	23.01	22.89	23.62	23.31	22.83	22.72
600	9.98	10.02	9.99	9.99	23.20	22.86	22.53	22.45	22.98	22.67	22.25	22.17
800	9.99	10.03	9.99	10.00	22.35	22.18	21.92	21.83	21.95	21.86	21.53	21.44
1000	10.00	10.04	10.01	10.01	21.54	21.48	21.21	21.14	21.07	21.05	20.69	20.62
2000	10.08	10.11	10.07	10.07	18.57	18.56	18.32	18.24	17.84	17.72	17.51	17.44
4000	10.20	10.24	10.21	10.21	15.98	16.06	15.89	15.86	14.85	14.76	14.59	14.57
6000	10.31	10.34	10.31	10.32	15.03	15.16	15.15	15.15	14.12	14.48	14.25	14.24
8000	10.27	10.29	10.27	10.27	15.78	15.77	15.82	15.82	16.05	15.94	16.21	16.22
10000	10.04	10.06	10.05	10.05	21.40	20.64	20.57	20.55	20.07	20.85	20.54	20.46
12000	9.97	9.98	9.96	9.97	26.35	26.84	26.90	26.80	29.48	28.92	29.83	29.73
14000	10.27	10.25	10.24	10.24	15.63	16.97	17.16	17.21	14.96	15.91	15.82	15.89
16000	10.31	10.33	10.29	10.29	14.44	14.97	15.44	15.59	13.77	13.90	14.52	14.70
18000	10.17	10.17	10.16	10.17	16.08	16.02	16.13	16.32	16.45	16.75	17.07	17.20
20000	10.02	10.01	10.01	10.01	22.88	22.19	22.42	22.20	30.65	32.40	29.21	28.20
22000	10.08	10.04	10.04	10.04	19.30	21.37	21.34	21.45	18.74	20.38	20.88	21.16
24000	10.03	10.03	10.02	10.01	19.78	18.88	19.73	20.31	18.73	19.66	20.53	21.03
26000	10.09	10.08	10.09	10.10	16.01	17.40	17.39	17.29	17.26	16.58	16.70	16.63
28000	10.13	10.11	10.13	10.15	16.06	16.58	16.92	16.85	13.73	15.50	14.76	14.51
30000	10.09	10.09	10.08	10.08	16.48	15.43	15.98	16.21	17.84	16.45	17.68	17.90
32000	10.10	9.90	9.95	9.95	15.65	15.88	15.98	16.25	17.71	20.50	20.15	20.22
34000	9.72	9.65	9.70	9.71	50.33	24.37	27.31	27.42	22.29	20.93	21.41	21.37
36000	10.09	9.97	10.03	10.04	12.36	15.24	14.81	14.79	11.62	12.54	12.42	12.65
38000	9.96	9.95	9.95	9.96	14.20	12.98	14.38	14.95	11.58	12.73	13.51	13.81
40000	9.70	9.60	9.66	9.67	13.43	17.43	17.44	17.53	18.12	18.46	19.74	20.19
42000	9.66	9.53	9.62	9.65	21.06	17.73	18.17	18.14	18.20	18.59	17.86	17.29
43500	9.85	9.59	9.66	9.67	15.90	15.78	15.46	15.32	19.50	16.33	16.60	16.56
44000	9.82	9.59	9.66	9.66	16.55	15.47	15.66	15.61	19.80	16.01	16.60	16.76
45000	9.80	9.60	9.63	9.62	17.20	15.92	16.48	16.83	15.56	15.98	15.95	16.32
46000	9.84	9.62	9.61	9.60	14.50	16.65	16.68	17.14	13.63	14.45	15.64	16.20
48000	9.63	9.62	9.60	9.58	14.65	13.58	14.99	15.31	12.81	12.62	14.48	14.81
50000	9.50	9.33	9.44	9.45	11.76	16.07	15.28	15.10	12.42	15.29	14.45	14.30

Typical Performance Curves

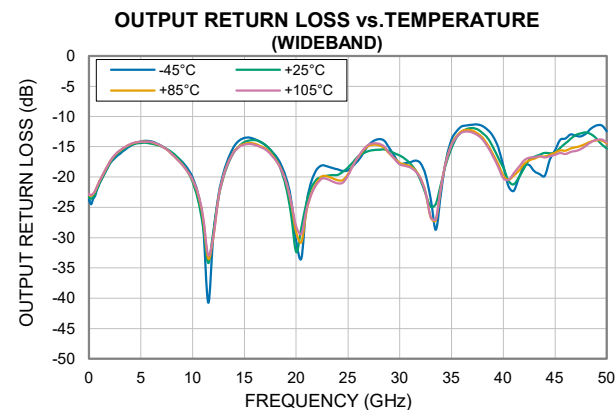
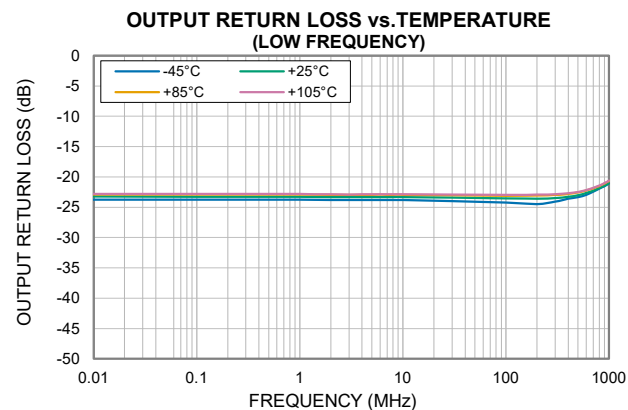
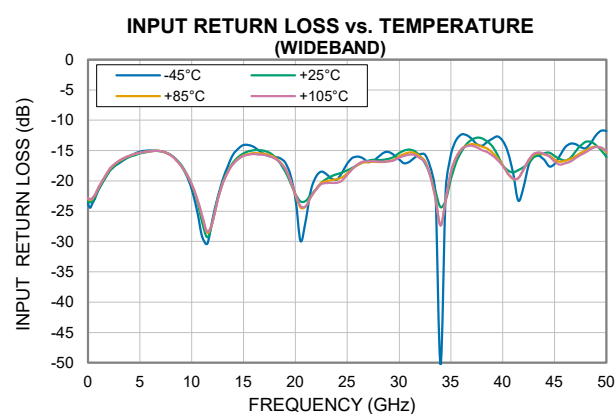
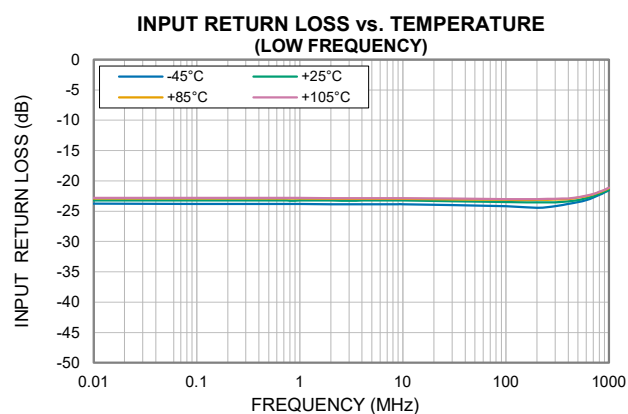
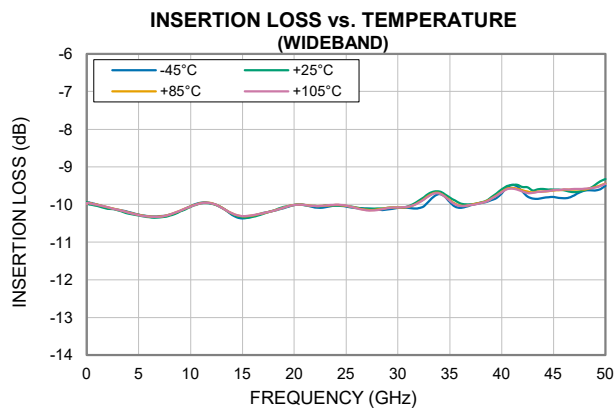
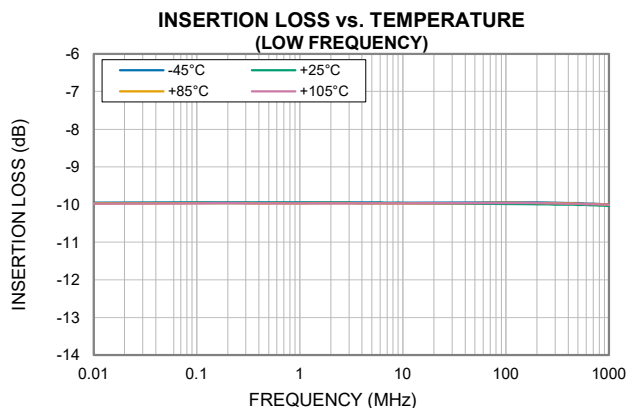

Outline Dimensions

BBS3016

TOP VIEW

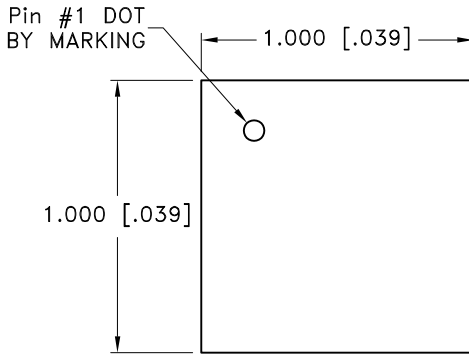

BOTTOM VIEW

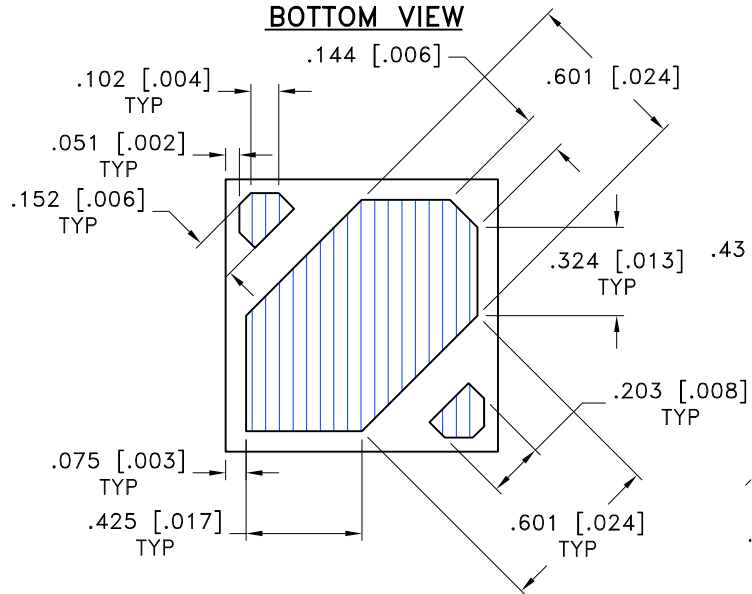

SIDE VIEW

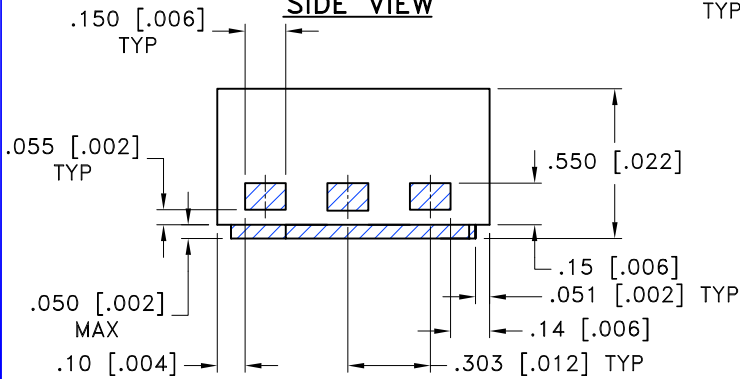

PCB LAND PATTERN

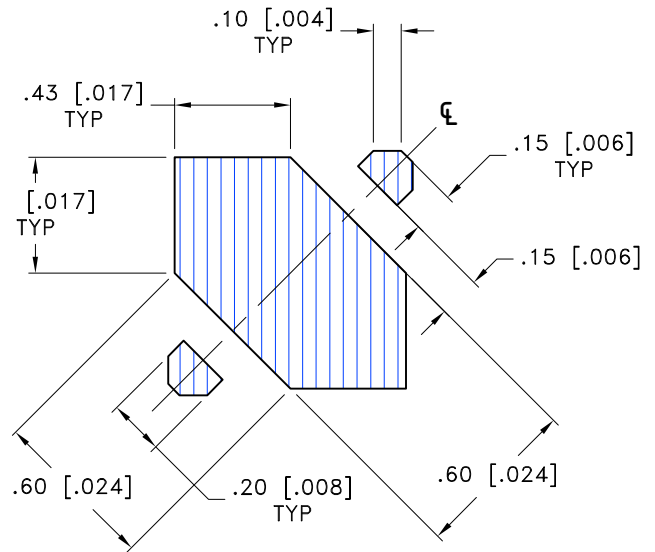

DENOTES METALLIZATION

SUGGESTED PCB LAND PATTERN

Tolerance to be within ± 0.05

Weight: 0.002 grams

Dimensions are in mm [inches]. Tolerances: 3 Pl. ± 0.050 mm

Notes:

1. Case material: Plastic.
2. Termination finish: Matte-Tin plated .



P.O. Box 350166, Brooklyn, New York 11235-0003 (718) 934-4500 Fax (718) 332-4661 For detailed performance specs & shopping online see Mini-Circuits web site



The Design Engineers Search Engine Provides ACTUAL Data Instantly From MINI-CIRCUITS At: www.minicircuits.com

RF/IF MICROWAVE COMPONENTS

Tape & Reel Packaging TR-F66

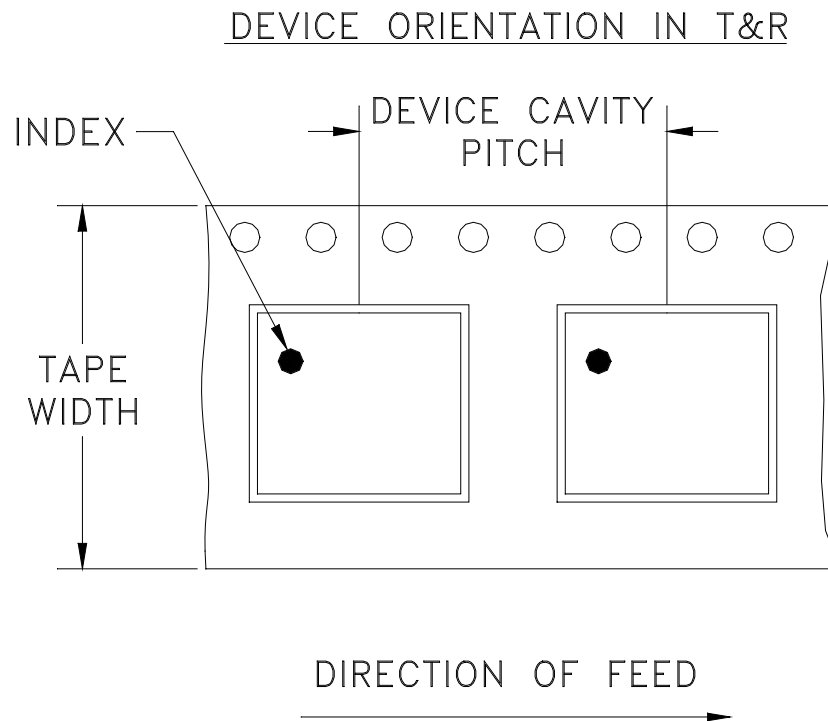

Tape Width, mm	Device Cavity Pitch, mm	Reel Size, inches	Devices per Reel see note	
8	4	7	Small quantity standard	20
				50
				100
				200
				500
		7	Standard	1000, 2000, 3000

Note: Please consult individual model data sheet to determine device per reel availability.

Mini-Circuits carrier tape materials provide protection from ESD (Electro-Static Discharge) during handling and transportation. Tapes are static dissipative and comply with industry standards EIA-481/EIA-541.

Go to: www.minicircuits.com/pages/pdfs/tape.pdf

Mini-Circuits®

INTERNET <http://www.minicircuits.com>

P.O. Box 350166, Brooklyn, New York 11235-0003 (718) 934-4500 Fax (718) 332-4661

Distribution Centers NORTH AMERICA 800-654-7949 • 417-335-5935 • Fax 417-335-5945 • EUROPE 44-1252-832600 • Fax 44-1252-837010

Mini-Circuits ISO 9001 & ISO 14001 Certified

THIRD ANGLE PROJECTION

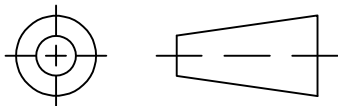

REVISIONS

REV	ECN No.	DESCRIPTION	DATE	DR	AUTH
OR	ECO-029149	NEW RELEASE	04/17/26	ITG	IL

SUGGESTED MOUNTING CONFIGURATION
FOR BBS3016 CASE STYLE.

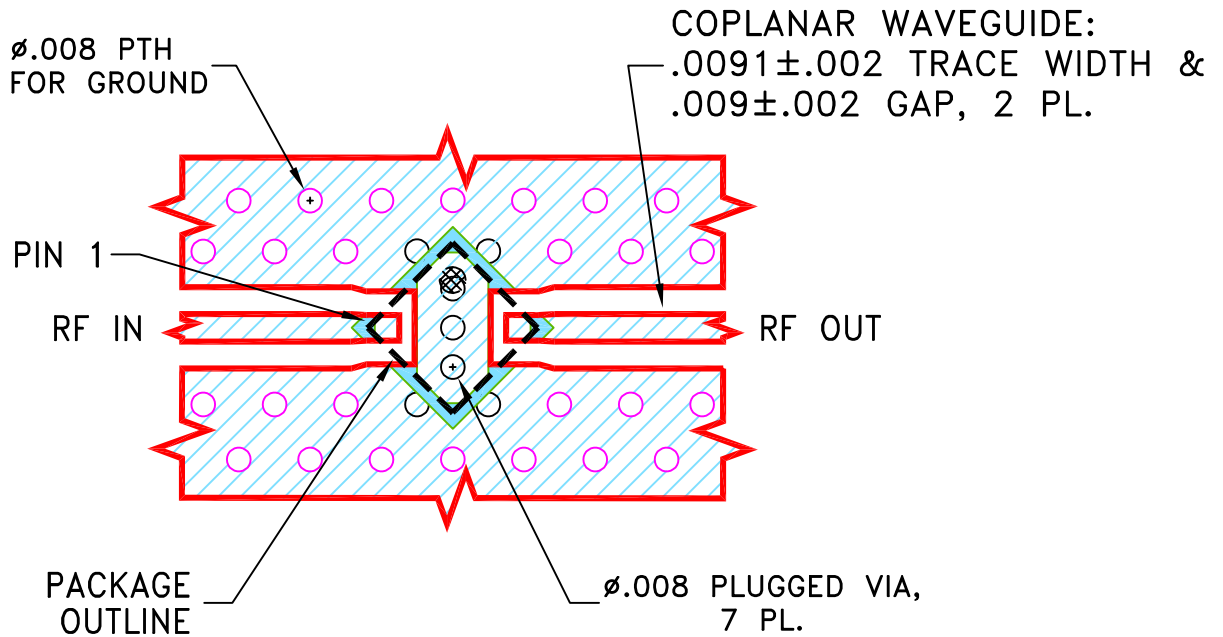

NOTES:

1. TRACE WIDTH AND GAP ARE SHOWN FOR ROGERS RO4350B WITH DIELECTRIC THICKNESS .0066"; COPPER: 1 OZ. EACH SIDE. FOR OTHER MATERIALS TRACE WIDTH AND GAP MAY NEED TO BE MODIFIED.
2. BOTTOM SIDE OF THE PCB IS CONTINUOUS GROUND PLANE.
3. EVALUATION BOARD P/N: TB-XAT-XXC+ (WHERE XX= 0,3,4,5,6,7,8,9,10,12,15,20)



DENOTES PCB COPPER LAYOUT WITH SMOBC (SOLDER MASK OVER BARE COPPER).

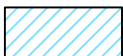

DENOTES COPPER LAND PATTERN FREE OF SOLDER MASK.

UNLESS OTHERWISE SPECIFIED	INITIALS		DATE
DIMENSIONS ARE IN INCHES	DRAWN	ITG	04/09/26
TOLERANCES ON:	CHECKED	NP	04/09/26
2 PL DECIMALS ±	APPROVED	IL	04/09/26
3 PL DECIMALS ± .005			
ANGLES ±			
FRACTIONS ±			



Mini-Circuits[®]

13 Neptune Avenue
Brooklyn NY 11235

PL, BBS3016, TB-XAT-XXC+

SIZE A	CODE IDENT 15542	DRAWING NO: 98-PL-861	REV: OR
FILE: 98PL861	SCALE: 15:1	SHEET: 1 OF 1	

Mini-Circuits[®]
THIS DOCUMENT AND ITS CONTENTS ARE THE PROPERTY OF MINI-CIRCUITS. EXCEPT FOR USE EXPRESSLY GRANTED, IN WRITING, TO ITS VENDORS, VENDEE AND THE UNITED STATES GOVERNMENT, MINI-CIRCUITS RESERVES ALL PROPRIETARY DESIGN, USE, MANUFACTURING AND REPRODUCTION RIGHTS THERETO. THESE CONTENTS SHALL NOT BE USED, DUPLICATED OR DISCLOSED TO ANY OUTSIDE PARTY, IN WHOLE OR IN PART, WITHOUT WRITTEN PERMISSION OF MINI-CIRCUITS.

Evaluation Board and Circuit

SEE DETAIL "A"

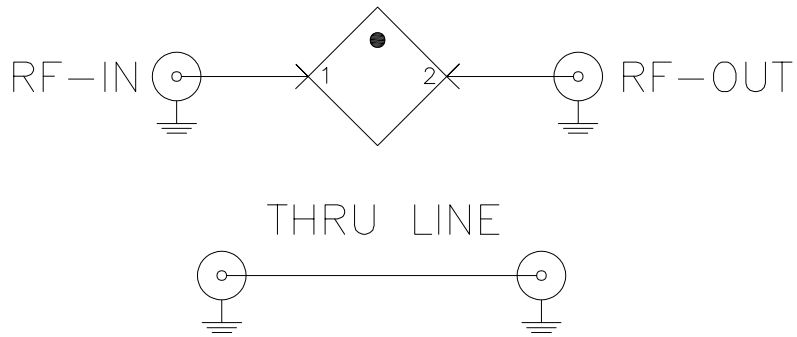
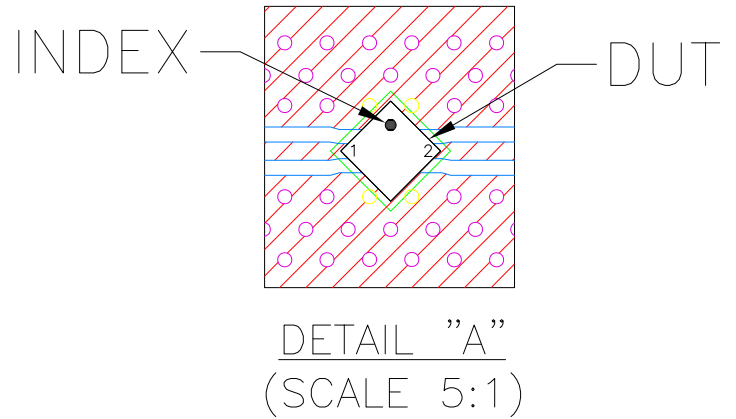
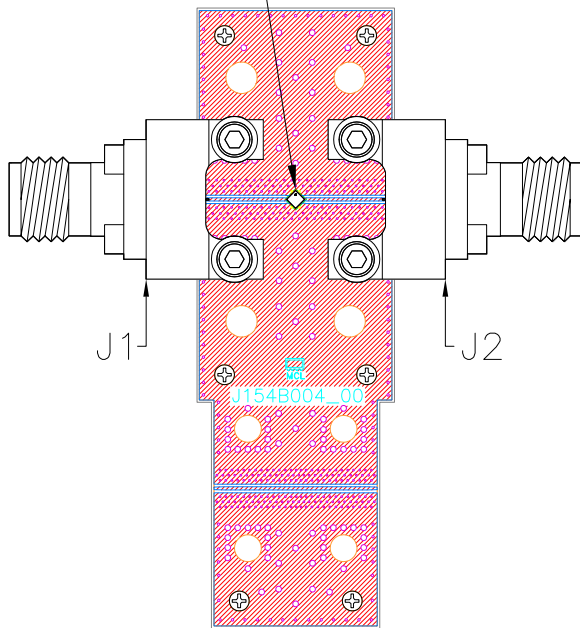

SCHEMATIC DIAGRAM
(SCALE 5:1)

Function	Pad
RF-IN	1
RF-OUT	2

Component	Size	Value	Part Number	Manufacturer
J1,J2	N/A	N/A	1892-04A-6	Southwest

NOTES:

- 1.85mm Female Connectors.
- PCB Material: Roger R04350B or equivalent, Dielectric constant=3.5, Thickness=0.0066 inch



All Mini-Circuits products are manufactured under exacting quality assurance and control standards, and are capable of meeting published specifications after being subjected to any or all of the following physical and environmental test.

Specification	Test/Inspection Condition	Reference/Spec
Operating Temperature	-40° to 85° C or -45° to 85° C or -55° to 105° C or -40° to 105° C or -40° to 95° C Ambient Environment	Individual Model Data Sheet
Storage Temperature	-55° to 100° C or -65° to 150° Ambient Environment	Individual Model Data Sheet
HTOL	1000 hours at 125°C	MIL-STD-883, Method 1005, Condition B
Thermal Shock	-55° to 100°C, 100 cycles	MIL-STD-202, Method 107, Condition A-3, except +100°C
Mechanical Shock	1.5Kg, 0.5 ms, 5 shock pulses, Y1 direction only	MIL-STD-883, Method 2002, Condition B, except Y1 direction only
Vibration (Variable Frequency)	50g peak	MIL-STD-883, Method 2007, Condition B
Autoclave	15 psig, 100% RH, 121°C, 96 hours	JESD22-A102, Condition C
HAST	130°C, 85% RH, 96 hours	JESD22-A110
Solderability	10X Magnification	J-STD-002, Para 4.2.5, Test S, 95% Coverage
Solder Reflow Heat	Sn-Pb Eutetic Process: 240°C peak Pb-Free Process: 260°C peak	J-STD-020, Table 4-1, 4-2 and 5-2; Figure 5-1
Moisture Sensitivity: Level 1	Bake at 125°C for 24 hours Soak at 85°C/85% RH for 168 hours, Reflow 3 cycles at 260°C peak	J-STD-020



All Mini-Circuits products are manufactured under exacting quality assurance and control standards, and are capable of meeting published specifications after being subjected to any or all of the following physical and environmental test.

Specification	Test/Inspection Condition	Reference/Spec
Marking Resistance to Solvents	Isopropyl alcohol + mineral spirits at 25°C; terpene defluxer at 25°C; distilled water + proylene glycol monomethyl ether + monoethanolamine at 63°C to 70°C	MIL-STD-202, Method 215