



MMIC REFLECTIONLESS

# Band Pass Filter

## XBF-183+

50Ω 17.5 to 18.5 GHz

### THE BIG DEAL

- Match to 50Ω in the stop band, eliminates undesired reflections
- Cascadable
- Good stopband rejection, 49 dB typ.
- Temperature stable, up to 105°C
- Small size, 4 x 4 mm
- Protected by US Patents 8,392,495; 9,705,467, additional patent pending
- Protected by China Patent 201080014266.1
- Protected by Taiwan Patent I581494

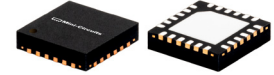

Generic photo used for illustration purposes only

CASE STYLE: DG1847

### +RoHS Compliant

The +Suffix identifies RoHS Compliance. See our website for methodologies and qualifications

### APPLICATIONS

- Transmitters & Receivers
- Harmonic Rejection
- Spurious Rejection

### GENERAL DESCRIPTION

Mini-Circuits' XBF-183+ four-section reflectionless filter employs a novel filter topology which absorbs and terminates stop band signals internally rather than reflecting them back to the source. This new capability enables unique applications for filter circuits beyond those suited to traditional approaches. Traditional filters are reflective in the stop band, sending signals back to the source at 100% of the power level. These reflections interact with neighboring components and often result in inter-modulation and other interferences. Reflectionless filters eliminate stop band reflections, allowing them to be paired with sensitive devices and used in applications that otherwise require circuits such as isolation amplifiers or attenuators.

### KEY FEATURES

Features	Advantages
Easy integration with sensitive reflective components, e.g. mixers, multipliers	Reflectionless filters absorb unwanted signals, preventing reflections back to the source. This reduces generation of additional unwanted signals without the need for extra components like attenuators, improving system dynamic range and saving board space.
High stopband rejection, up to 60 dB	Ideal for applications where suppression of strong spurious signals and intermodulation products is needed.
Enables stable integration of wideband amplifiers	Because reflectionless filters maintain good impedance in the stop band; they can be integrated with high gain, wideband amplifiers without the risk of creating instabilities in these out of band regions.
Cascadable	Reflectionless filters can be cascaded in multiple sections to provide sharper and higher attenuation, while also preventing any standing waves that could affect pass band signals.
Excellent power handling in a tiny surface mount device up to 0.5W in passband	High power handling extends the usability of these filters to the transmit path for inter-stage filtering.
Small size, 4x4mm MCLP	Allows replacement of filter/attenuator pairs with a single reflectionless filter, saving board space. Tiny footprint saves space in dense layouts while providing low inductance, repeatable transitions, and excellent thermal contact to the PCB.
Excellent repeatability of RF performance	Through semiconductor IPD process, X-series filters are inherently repeatable for large volume production.
Operating temperature up to 105 °C	Suitable for operation close to high power components.

\*IPD - Integrated Passive Device, is a GaAs semiconductor process





MMIC REFLECTIONLESS

# Band Pass Filter

## XBF-183+

Mini-Circuits

50Ω 17.5 to 18.5 GHz

### ELECTRICAL SPECIFICATIONS<sup>1</sup> AT +25°C

Parameter		F#	Frequency (MHz)	Min.	Typ.	Max.	Unit
Pass Band	Insertion Loss	F2-F3	17500 - 18500	–	4.9	5.8	dB
	VSWR	F2-F3	17500 - 18500	–	1.6	–	:1
Stop Band, Lower	Rejection	DC-F1	DC - 9000	43	67	–	dB
	VSWR	DC-F1	DC - 9000	–	1.2	–	:1
Stop Band, Upper	Rejection	F4-F5	27000 - 32000	39	56	–	dB
		F5-F6	32000 - 40000	32	43	–	
	VSWR	F4-F5	27000 - 32000	–	2.2	–	:1
		F5-F6	32000 - 40000	–	3.0	–	

1. Measured on Mini-Circuits Characterization Test Board TB-968-183+

### ABSOLUTE MAXIMUM RATINGS<sup>2</sup>

Parameter	Ratings
Operating Temperature	-55°C to +105°C
Storage Temperature	-65°C to +150°C
RF Power Input, Passband (F2-F3) <sup>3</sup>	0.5 W at 25°C
RF Power Input, Stopband (DC-F2, F3-F6) <sup>4</sup>	0.16 W at 25°C

- 2. Permanent damage may occur if any of these limits are exceeded.
- 3. Passband rating derates linearly to 0.25 W at 105°C ambient
- 4. Stopband rating derates linearly to 0.08 W at 105°C ambient

### SPECIFICATION DEFINITION

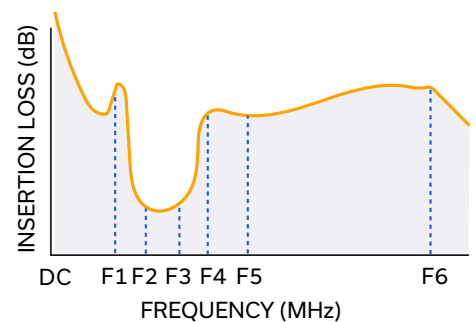



MMIC REFLECTIONLESS

# Band Pass Filter

## XBF-183+

Mini-Circuits

50Ω 17.5 to 18.5 GHz

### SIMPLIFIED SCHEMATIC AND PAD DESCRIPTION

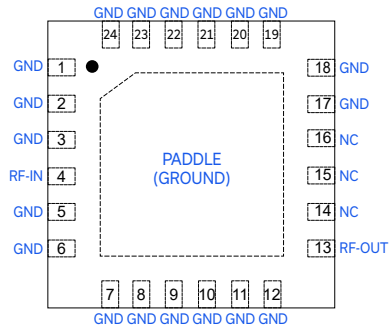
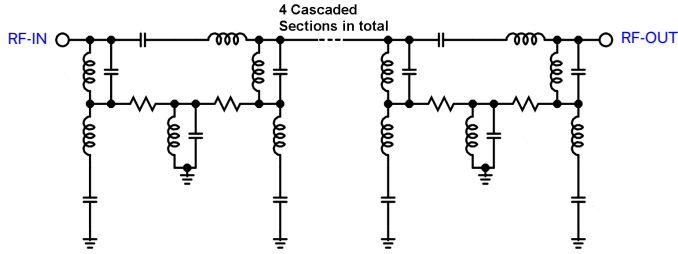

Function	Pad Number	Description
RF-IN	4	RF Input Pad
RF-OUT	13	RF Output Pad
GND	1-3, 5-12, 17-24 & paddle	Connected to ground
NC (GND Externally)	14-16	No internal connection

### PRODUCT MARKING

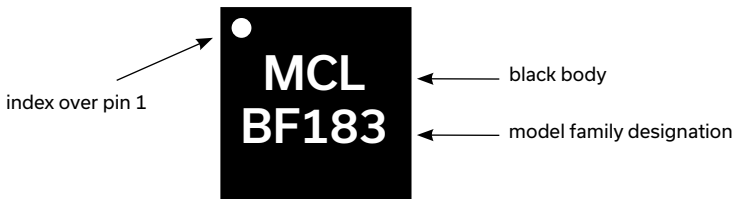

Marking may contain other features or characters for internal lot control



MMIC REFLECTIONLESS

# Band Pass Filter

## XBF-183+

Mini-Circuits

50Ω 17.5 to 18.5 GHz

### TYPICAL PERFORMANCE DATA AT +25°C

Frequency (GHz)	Insertion Loss (dB)	VSWR (:1)
0.01	99.01	1.05
0.1	97.17	1.06
0.5	89.45	1.08
1.0	83.97	1.09
5.0	55.73	1.11
10.0	61.60	1.35
12.0	11.86	1.33
14.0	5.01	1.15
17.5	4.26	1.56
18.5	4.34	1.18
20.0	5.14	1.03
22.0	8.56	1.39
24.0	22.19	1.37
26.0	53.42	1.31
28.0	59.65	1.77
30.0	54.79	1.89
32.0	48.28	1.71
36.0	43.86	1.41
40.0	52.07	4.38

XBF-183+  
INSERTION LOSS

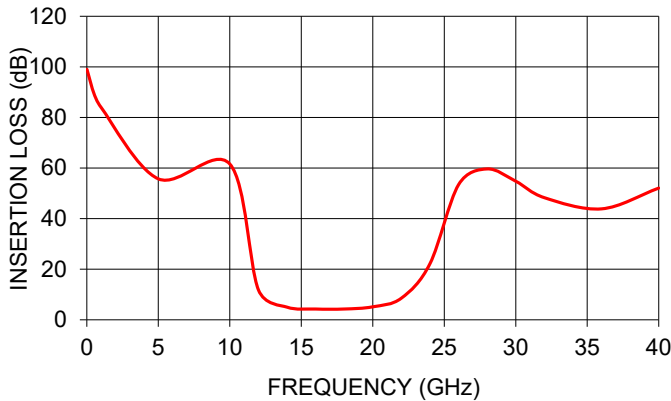

XBF-183+  
VSWR

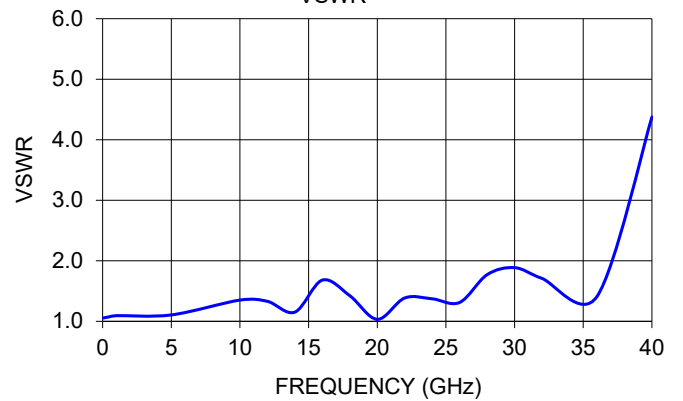



MMIC REFLECTIONLESS

# Band Pass Filter

## XBF-183+

Mini-Circuits

50Ω 17.5 to 18.5 GHz

ADDITIONAL DETAILED TECHNICAL INFORMATION IS AVAILABLE ON OUR DASH BOARD. TO ACCESS [CLICK HERE](#)

Performance Data and Graphs	Data Graphs S-Parameter (S3P Files) Data Set (.zip file)
Case Style	DG1847 Plastic package, exposed paddle lead finish: matte-tin
Tape & Reel Standard quantities available on reel	F66 7" reels with 20, 50, 100, 200, 500 or 1000 devices 13" reels with 2000, 3000, and 4000 devices
Suggested Layout for PCB Design	PL-451
Evaluation Board	TB-844-282B+ (without connectors) TB-844-282BC+ (with connectors) B20-118-F1+ Connector sold separately
Environmental Ratings	ENV82

### ESD RATING

Human body model (HBM): Class 2(2000 to <4000 V) in accordance with ANSI/ESD 5.1-20012001

### MSL TEST FLOW CHART

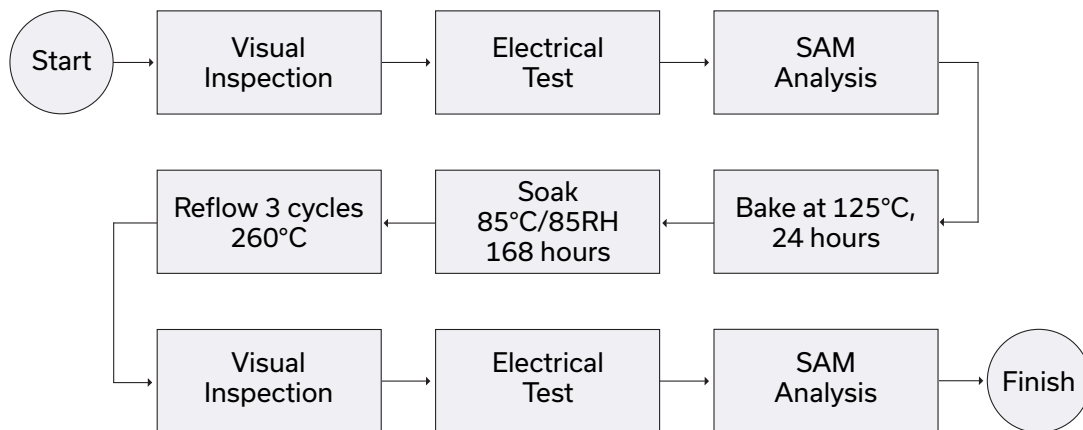



### REFLECTIONLESS FILTER APPLICATION NOTE

Application Circuit Example: Pairing mixers with reflectionless filters to improve system dynamic range

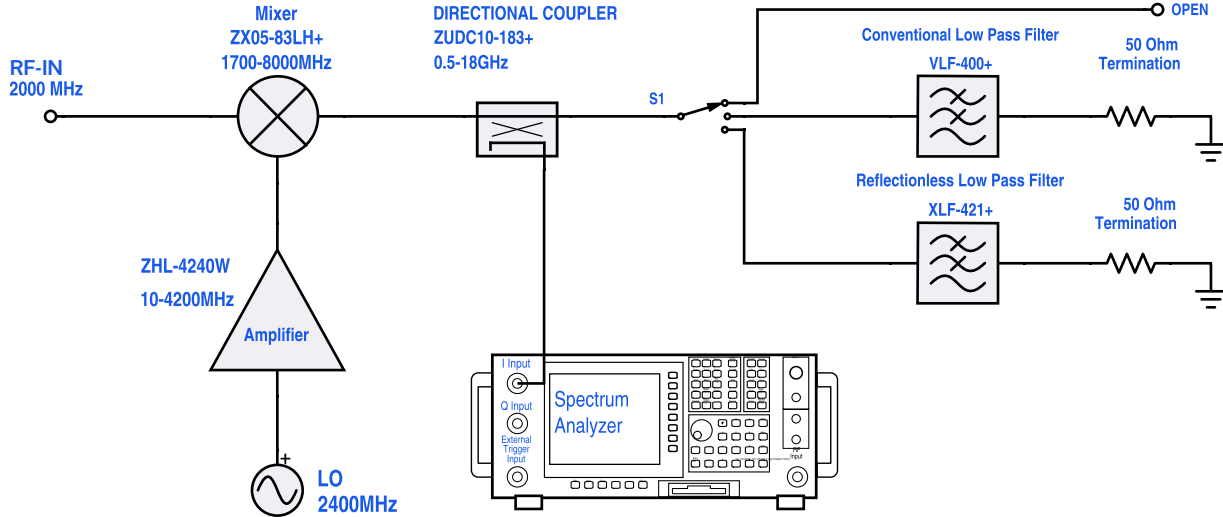

Test block diagram: IF output reflection spectrum with single input frequency

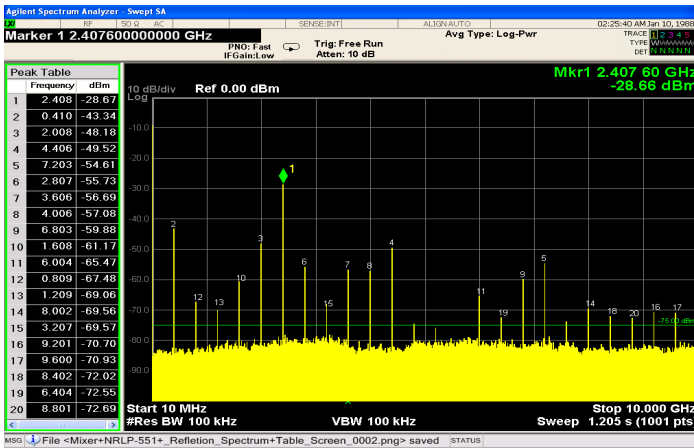

Figure 1. IF output reflection spectrum without filter

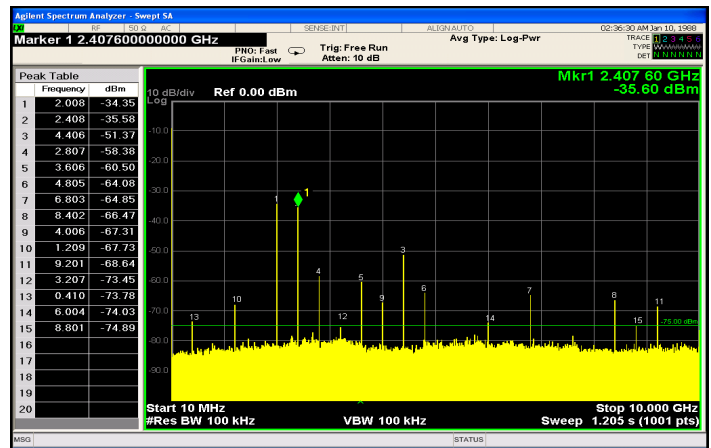

Figure 2. IF output reflection spectrum with conventional filter

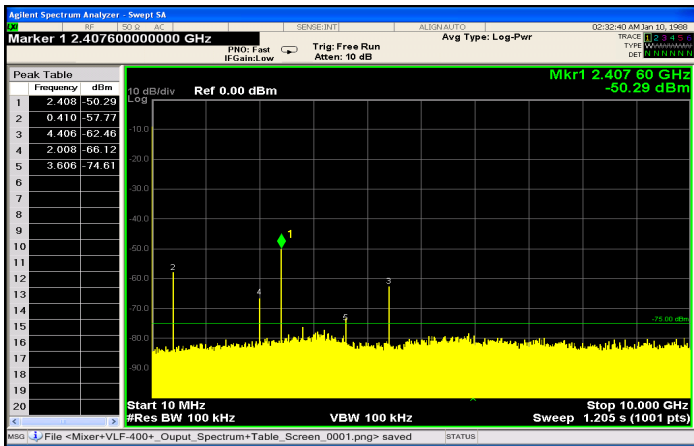

Figure 3. IF output reflection spectrum with reflectionless filter

An application circuit was assembled to measure the IF reflection spectrum at the output of a mixer when the mixer was paired with a conventional filter versus a reflectionless filter.

While the conventional filter reduces the reflections present when the mixer is used alone (no filter), the reflectionless filter virtually eliminates those reflections altogether.

The reflected signal at marker 1 in the figures above exhibits a reduction of more than 20 dB from -28.7 dBm to -50.3 dBm when the reflectionless filter is used as compared to the conventional filter, thus eliminating unwanted spurious mixing products and improving system dynamic range.

For more information, refer to application note [AN-75-007](#)

#### NOTES

- A. Performance and quality attributes and conditions not expressly stated in this specification document are intended to be excluded and do not form a part of this specification document.
- B. Electrical specifications and performance data contained in this specification document are based on Mini-Circuit's applicable established test performance criteria and measurement instructions.
- C. The parts covered by this specification document are subject to Mini-Circuits standard limited warranty and terms and conditions (collectively, "Standard Terms"); Purchasers of this part are entitled to the rights and benefits contained therein. For a full statement of the standard terms and the exclusive rights and remedies thereunder, please visit Mini-Circuits' website at [www.minicircuits.com/terms/viewterm.html](http://www.minicircuits.com/terms/viewterm.html)

*Typical Performance Data*

FREQ. (GHz)	INSERTION LOSS (dB)			INPUT VSWR (:1)			OUTPUT VSWR (:1)		
	@-55°C	@25°C	@+105°C	@-55°C	@+25°C	@+105°C	@-55°C	@+25°C	@+105°C
0.01	80.19	99.01	88.83	1.05	1.05	1.06	1.09	1.32	1.24
0.05	99.20	95.16	90.29	1.06	1.06	1.06	1.09	1.31	1.24
0.1	95.05	97.17	98.87	1.06	1.06	1.06	1.08	1.31	1.24
0.3	93.12	90.89	92.40	1.08	1.07	1.06	1.07	1.30	1.24
0.5	89.17	89.45	89.20	1.08	1.08	1.07	1.08	1.29	1.23
0.7	85.71	85.53	88.01	1.08	1.08	1.08	1.08	1.29	1.22
1.0	83.21	83.97	82.90	1.09	1.09	1.09	1.07	1.29	1.22
2.0	78.26	79.05	80.05	1.12	1.14	1.14	1.08	1.29	1.22
3.0	71.51	71.12	71.05	1.15	1.15	1.13	1.10	1.33	1.27
4.0	60.86	61.79	61.36	1.11	1.11	1.11	1.15	1.37	1.29
5.0	54.87	55.73	55.91	1.10	1.11	1.12	1.20	1.36	1.27
6.0	52.33	53.21	53.30	1.24	1.20	1.19	1.26	1.27	1.19
7.0	53.35	54.21	54.51	1.39	1.37	1.36	1.23	1.16	1.10
8.0	61.91	61.55	62.08	1.46	1.46	1.44	1.15	1.17	1.10
9.0	64.92	64.78	64.93	1.50	1.50	1.46	1.06	1.41	1.32
10.0	60.91	61.60	59.95	1.47	1.35	1.29	1.32	1.66	1.53
11.0	30.07	28.83	28.00	1.30	1.24	1.19	1.35	1.45	1.37
12.0	11.15	11.86	12.34	1.30	1.33	1.35	1.08	1.06	1.04
13.0	5.58	6.65	7.36	1.25	1.26	1.27	1.26	1.26	1.22
14.0	3.98	5.01	5.74	1.06	1.15	1.20	1.29	1.29	1.26
15.0	3.60	4.55	5.28	1.66	1.64	1.63	1.54	1.46	1.40
16.0	3.37	4.26	5.03	1.83	1.68	1.69	1.31	1.20	1.16
16.2	3.35	4.26	5.02	1.84	1.73	1.71	1.33	1.25	1.21
16.4	3.29	4.22	5.00	1.76	1.68	1.67	1.31	1.29	1.27
16.6	3.28	4.21	4.99	1.76	1.63	1.61	1.44	1.41	1.42
16.8	3.32	4.24	5.02	1.81	1.66	1.59	1.55	1.53	1.56
17.0	3.32	4.25	5.04	1.82	1.66	1.57	1.62	1.60	1.63
17.2	3.31	4.23	5.03	1.79	1.57	1.49	1.68	1.62	1.65
17.4	3.31	4.24	5.04	1.77	1.55	1.43	1.69	1.65	1.67
17.5	3.31	4.26	5.07	1.74	1.56	1.43	1.72	1.67	1.67
17.8	3.30	4.25	5.08	1.64	1.47	1.37	1.75	1.65	1.64
18.0	3.29	4.27	5.11	1.56	1.42	1.35	1.74	1.65	1.64
18.2	3.29	4.30	5.16	1.44	1.38	1.31	1.72	1.64	1.64
18.4	3.27	4.30	5.19	1.26	1.22	1.18	1.66	1.60	1.60
18.5	3.28	4.34	5.24	1.22	1.18	1.15	1.63	1.59	1.58
18.8	3.34	4.42	5.33	1.24	1.21	1.16	1.63	1.59	1.57
19.0	3.43	4.51	5.45	1.22	1.16	1.15	1.71	1.62	1.62
20.0	3.89	5.14	6.20	1.11	1.03	1.09	1.69	1.65	1.62
21.0	4.85	6.38	7.64	1.34	1.42	1.45	1.77	1.78	1.70
22.0	6.72	8.56	10.16	1.50	1.39	1.35	1.80	1.65	1.54
23.0	10.66	13.23	15.45	1.39	1.39	1.39	1.81	1.78	1.73
24.0	18.81	22.19	25.20	1.42	1.37	1.36	2.03	2.06	2.12
25.0	32.98	36.64	39.97	1.46	1.41	1.33	2.83	2.70	2.72
26.0	51.80	53.42	54.70	1.41	1.31	1.31	3.99	3.77	3.64
27.0	57.85	59.14	58.07	1.42	1.46	1.56	4.51	3.99	3.51
28.0	58.73	59.65	59.09	1.70	1.77	1.75	4.04	3.66	3.15
29.0	57.88	58.16	57.35	1.94	1.88	1.74	3.18	2.83	2.54
30.0	55.05	54.79	55.71	1.93	1.89	1.76	2.29	2.09	1.88
31.0	51.58	51.96	51.79	1.83	1.84	1.82	1.80	1.64	1.60
32.0	46.60	48.28	47.28	2.06	1.71	1.64	1.90	1.73	1.65
33.0	42.46	42.97	42.66	2.17	1.80	1.76	1.68	1.57	1.37
34.0	38.46	37.76	39.04	2.04	1.71	1.68	2.30	2.08	2.15
35.0	42.32	43.32	44.55	1.75	1.67	1.63	7.60	5.86	4.62
36.0	43.86	43.86	44.08	1.43	1.41	1.37	10.13	6.88	5.30
37.0	42.09	42.87	43.12	1.37	1.44	1.37	9.17	6.07	4.84
38.0	40.68	40.87	40.11	1.58	1.68	1.64	9.31	6.44	5.22
39.0	44.84	46.50	51.47	2.64	2.66	2.72	13.68	8.62	7.39
40.0	52.36	52.07	52.80	4.73	4.38	4.34	13.79	8.63	8.46



## Typical Performance Curves

**INSERTION LOSS vs. TEMPERATURE (Full Band)**  
INPUT POWER = -10 dBm

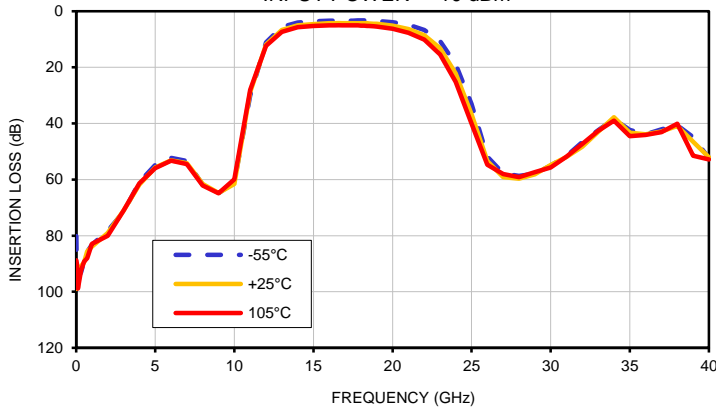

**INSERTION LOSS vs. TEMPERATURE (Pass Band)**  
INPUT POWER = -10 dBm

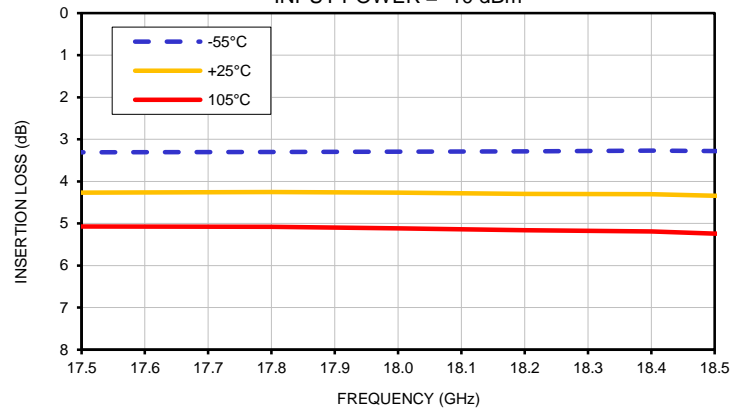

**INPUT VSWR vs. TEMPERATURE (Full Band)**  
INPUT POWER = -10 dBm

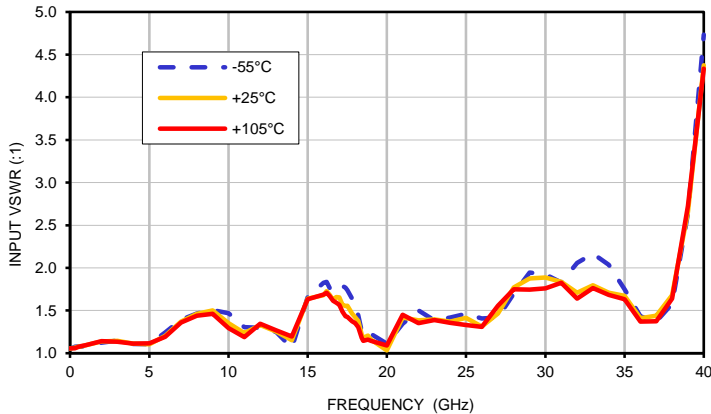

**INPUT VSWR vs. TEMPERATURE (Pass Band)**  
INPUT POWER = -10 dBm

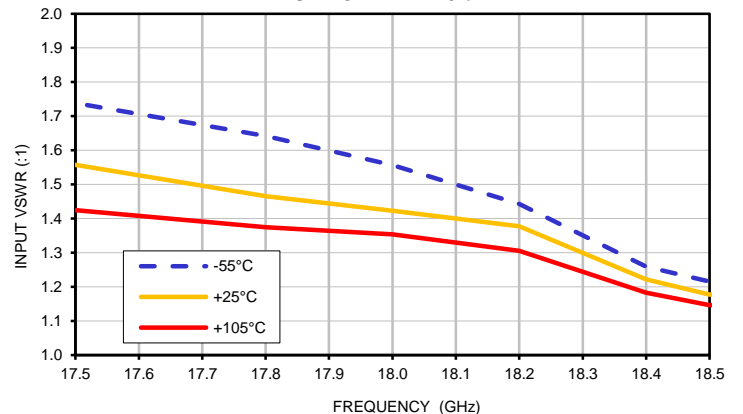

**OUTPUT VSWR vs. TEMPERATURE (Full Band)**  
INPUT POWER = -10 dBm

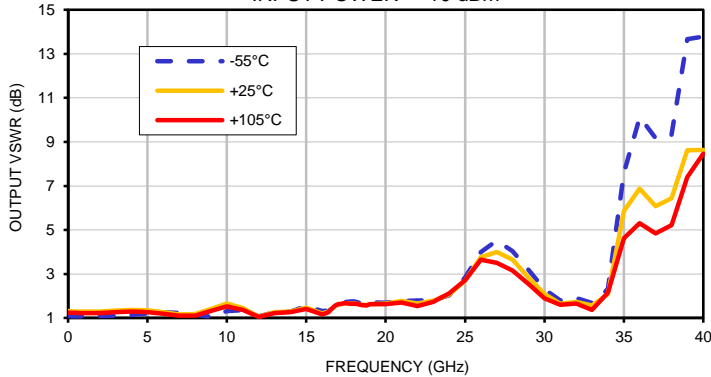

**OUTPUT VSWR vs. TEMPERATURE (Pass Band)**  
INPUT POWER = -10 dBm

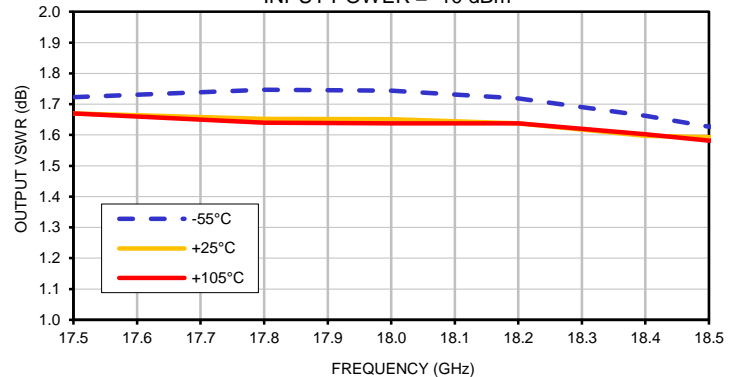

P.O. Box 350166, Brooklyn, New York 11235-0003 (718) 934-4500 • Fax (718) 332-4661 For detailed performance specs & shopping online see Mini-Circuits web site  
The Design Engineers Search Engine Provides ACTUAL Data Instantly From MINI-CIRCUITS At: [www.minicircuits.com](http://www.minicircuits.com)



IF/RF MICROWAVE COMPONENTS



REV. OR  
XLF-42M+  
6/18/2018  
Page 1 of 1

### Outline Dimensions

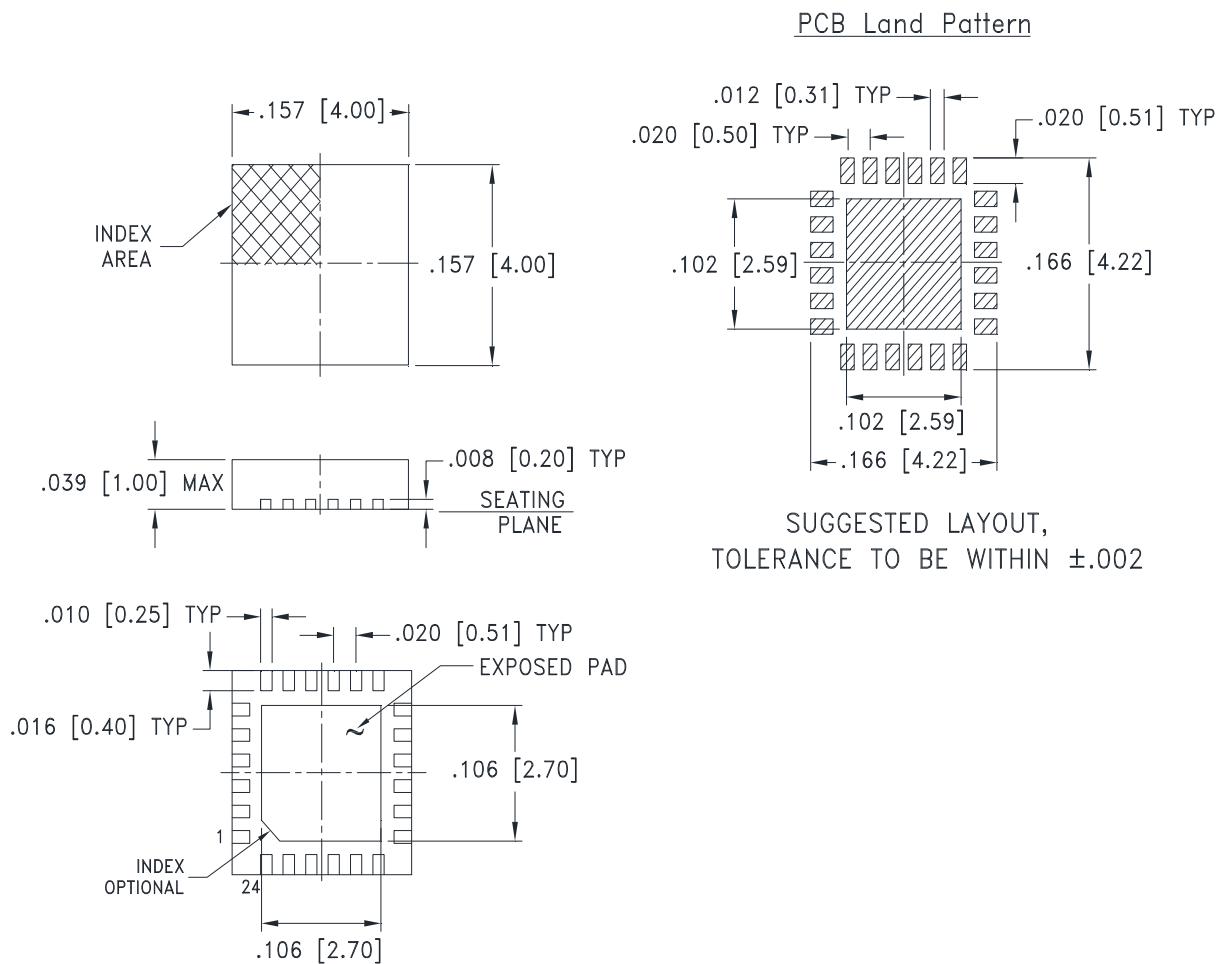

**Weight: .04 Grams**

**Dimensions are in inches (mm). Tolerances: 2 Pl.  $\pm$  .01; 3 Pl.  $\pm$  .005**

#### Notes:

- Case material: Plastic.
- Termination finish:
  - For RoHS Case Styles: Tin-Silver alloy plate over Nickel barrier or Matte-Tin. All models, (+) suffix. See model Data sheet.
  - For RoHS-5 Case Styles: Tin-Lead plate. All models, no (+) suffix.

**Mini-Circuits®**  
ISO 9001 ISO 14001 CERTIFIED

ALL NEW  
minicircuits.com

P.O. Box 350166, Brooklyn, New York 11235-0003 (718) 934-4500 Fax (718) 332-4661 For detailed performance specs & shopping online see Mini-Circuits web site



The Design Engineers Search Engine Provides ACTUAL Data Instantly From MINI-CIRCUITS At: [www.minicircuits.com](http://www.minicircuits.com)

RF/IF MICROWAVE COMPONENTS

# Tape & Reel Packaging TR-F68

## DEVICE ORIENTATION IN T&R

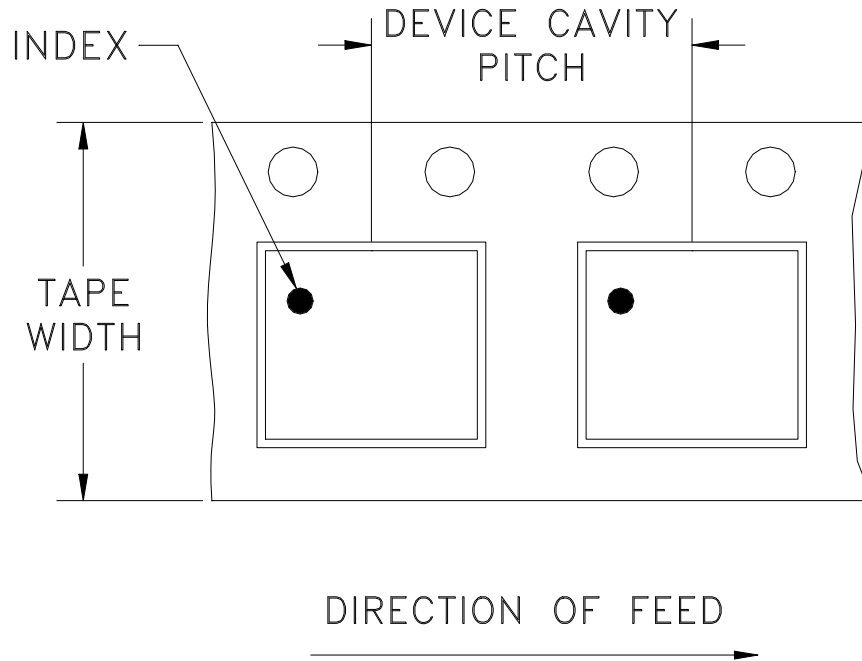

Tape Width, mm	Device Cavity Pitch, mm	Reel Size, inches	Devices per Reel see note	
12	8	7	Small quantity standard	20
				50
				100
				200
				500
		7	Standard	1000
		13	Standard	2000
				3000
4000				

Mini-Circuits carrier tape materials provide protection from ESD (Electro-Static Discharge) during handling and transportation. Tapes are static dissipative and comply with industry standards EIA-481/EIA-541.

Go to: [www.minicircuits.com/pages/pdfs/tape.pdf](http://www.minicircuits.com/pages/pdfs/tape.pdf)



INTERNET <http://www.minicircuits.com>

P.O. Box 350166, Brooklyn, New York 11235-0003 (718) 934-4500 Fax (718) 332-4661

Distribution Centers NORTH AMERICA 800-654-7949 • 417-335-5935 • Fax 417-335-5945 • EUROPE 44-1252-832600 • Fax 44-1252-837010

Mini-Circuits ISO 9001 & ISO 14001 Certified

THIRD ANGLE PROJECTION

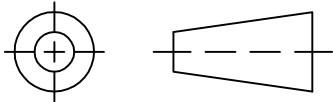

REVISIONS

REV	ECN No.	DESCRIPTION	DATE	DR	AUTH
OR	M168129	NEW RELEASE	05/30/18	ITG	GH
A	M170280	FIXED BOARD MATERIAL, WAS R04350B	09/27/18	NP	GH

SUGGESTED MOUNTING CONFIGURATION  
FOR DG1847 CASE STYLE, "24FL02" PIN CODE

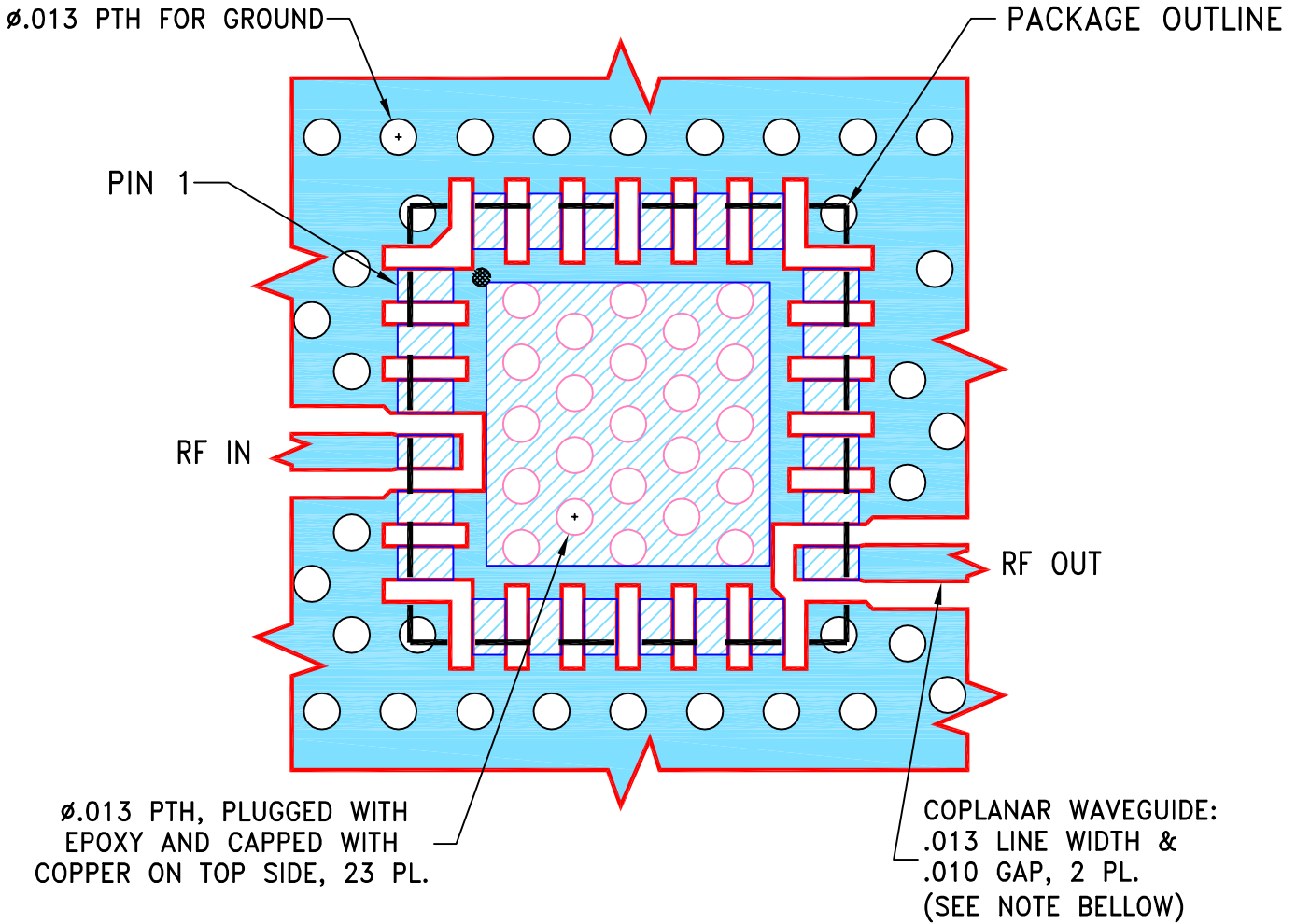

**NOTES:**

1. TRACE WIDTH IS SHOWN FOR ROGERS R04003 WITH DIELECTRIC THICKNESS .008±.001. COPPER: 1/2 OZ. EACH SIDE. FOR OTHER MATERIALS LINE WIDTH MAY NEED TO BE MODIFIED.
2. BOTTOM SIDE OF THE PCB IS CONTINUOUS GROUND PLANE.

- DENOTES PCB COPPER LAYOUT WITH SMOBC (SOLDER MASK OVER BARE COPPER).
- DENOTES COPPER LAND PATTERN FREE OF SOLDER MASK.

UNLESS OTHERWISE SPECIFIED	INITIALS	DATE
DIMENSIONS ARE IN INCHES	DRAWN ITG	05/29/18
TOLERANCES ON:	CHECKED GF	05/30/18
2 PL DECIMALS ±	APPROVED GH	05/30/18
3 PL DECIMALS ± .005		
ANGLES ±		
FRACTIONS ±		

**Mini-Circuits<sup>®</sup>** 13 Neptune Avenue  
Brooklyn NY 11235

PL, 24FL03, DG1847, TB-968-163+/  
TB-968-183+ / TB-968-24+

SIZE A	CODE IDENT 15542	DRAWING NO: 98-PL-591	REV: A
FILE: 98PL591	SCALE: 15:1	SHEET: 1 OF 1	

Mini-Circuits<sup>®</sup>  
THIS DOCUMENT AND ITS CONTENTS ARE THE PROPERTY OF MINI-CIRCUITS. EXCEPT FOR USE EXPRESSLY GRANTED, IN WRITING, TO ITS VENDORS, VENDEE AND THE UNITED STATES GOVERNMENT, MINI-CIRCUITS RESERVES ALL PROPRIETARY DESIGN, USE, MANUFACTURING AND REPRODUCTION RIGHTS THERETO. THESE CONTENTS SHALL NOT BE USED, DUPLICATED OR DISCLOSED TO ANY OUTSIDE PARTY, IN WHOLE OR IN PART, WITHOUT WRITTEN PERMISSION OF MINI-CIRCUITS.

# Evaluation Board and Circuit

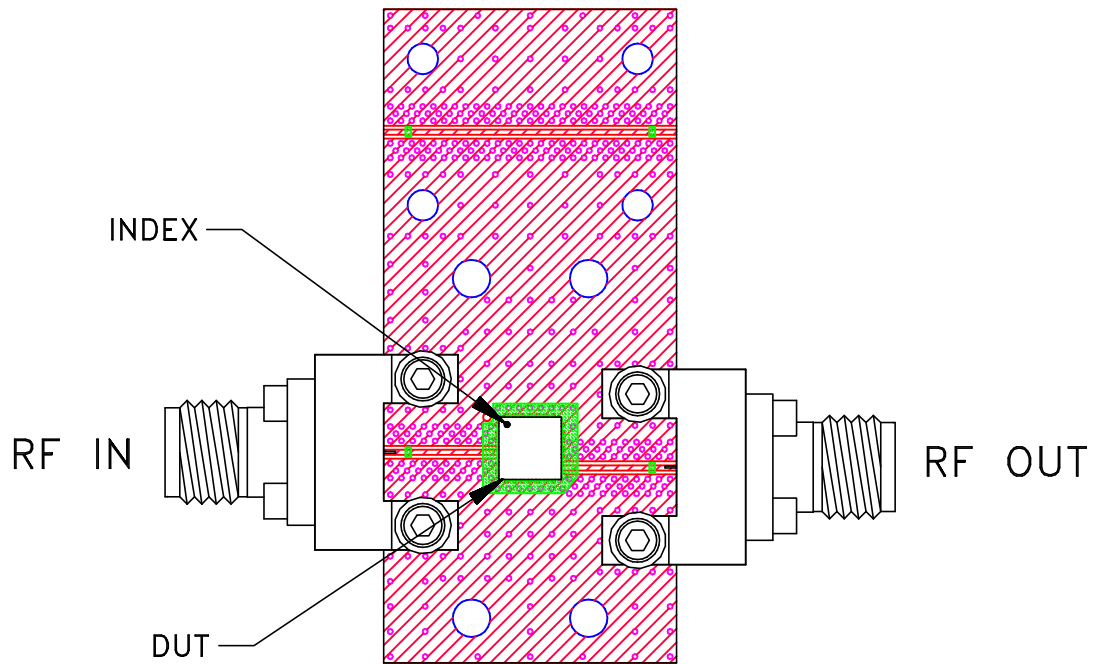

TB-968-183+

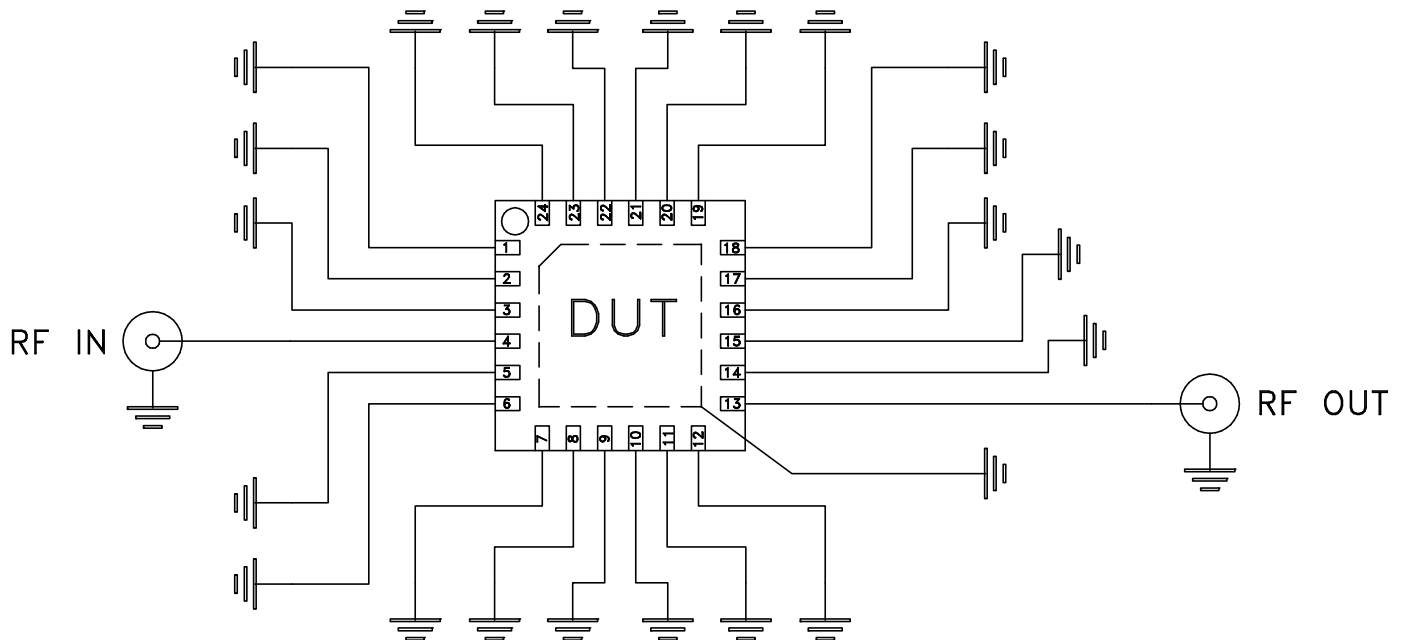

Schematic Diagram

## Note:

PCB Material: RO4003C or equivalent,  
Dielectric Constant=3.5, Thickness=.008 inch.

 **Mini-Circuits®**



All Mini-Circuits products are manufactured under exacting quality assurance and control standards, and are capable of meeting published specifications after being subjected to any or all of the following physical and environmental test.

Specification	Test/Inspection Condition	Reference/Spec
Operating Temperature	-55° to 105°C Ambient Environment	Individual Model Data Sheet
Storage Temperature	-65° to 150° C Ambient Environment	Individual Model Data Sheet
Autoclave	15 psig, 100% RH, 121°C, 96 hours	JESD22-A102-C, Condition C
Temperature Cycling	-65° to 150°C, 100 cycles	JESD22-A104
Temperature Humidity	85°C/ 85% RH, 168 hours	JESD22-113
Solder Reflow Heat	Sn-Pb Eutetic Process: 240°C peak Pb-Free Process: 260°C peak	J-STD-020, Table 4-1, 4-2 and 5-2; Figure 5-1
Moisture Sensitivity: Level 1	Bake at 125°C for 24 hours Soak at 85°C/85% RH for 168 hours, Reflow 3 cycles at 240°C peak (Non-RoHS) or 260°C (RoHS)	J-STD-020C
Solderability	10X magnification, 95% coverage	JESD22-B102, Method 1: Dip and Look Test
Marking Resistance to Solvents	Isopropyl alcohol + mineral spirits at 25°C; terpene defluxer at 25°C; distilled water + proylene glycol monomethyl ether + monoethanolamine at 63°C to 70°C	MIL-STD-202, Method 215