



MMIC REFLECTIONLESS

High Pass Filter

XHF2-912+

Mini-Circuits

50Ω 9.1 to 30 GHz

THE BIG DEAL

- Match to 50Ω in the stop band, eliminates undesired reflections
- Cascadable
- Excellent Power handling
- Temperature stable, up to 105°C
- Small size, 2 x 2 mm
- Protected by US Patent No. 8,392,495



Generic photo used for illustration purposes only

CASE STYLE: MC1630-1

+RoHS Compliant

The +Suffix identifies RoHS Compliance. See our website for methodologies and qualifications

APPLICATIONS

- Wi-Fi
- WiMax
- Microwave Radio
- Military & Space

GENERAL DESCRIPTION

Mini-Circuits' XHF2-912+ reflectionless filter employs a novel filter topology which absorbs and terminates stop band signals internally rather than reflecting them back to the source. This new capability enables unique applications for filter circuits beyond those suited to traditional approaches. Traditional filters are reflective in the stop band, sending signals back to the source at 100% of the power level. These reflections interact with neighboring components and often result in inter-modulation and other interferences. Reflectionless filters eliminate stop band reflections, allowing them to be paired with sensitive devices and used in applications that otherwise require circuits such as isolation amplifiers or attenuators.

KEY FEATURES

Feature	Advantages
Easy integration with sensitive reflective components, e.g. mixers, multipliers	Reflectionless filters absorb unwanted signals falling in filter stopband, preventing reflections back to the source. This reduces generation of additional unwanted signals without the need for extra components like attenuators, improving system dynamic range and saving board space.
Enables stable integration of wideband amplifiers	Because reflectionless filters maintain good impedance in the stopband; they can be integrated with high gain, wideband amplifiers without the risk of creating instabilities in these out of band regions.
Cascadable	Reflectionless filters can be cascaded in multiple sections to provide sharper and higher attenuation, while also preventing any standing waves that could affect passband signals. Low & highpass filters can be cascaded to realize bandpass filters.
Excellent power handling in a tiny surface mount device	High power handling extends the usability of these filters to the transmit path for inter-stage filtering.
Small size, 2x2mm QFN-Style	Allows replacement of filter/attenuator pairs with a single reflectionless filter, saving board space.
Excellent repeatability of RF performance	Through semiconductor IPD process, X-series filters are inherently repeatable for large volume production.
Operating temperature up to +105 °C	Suitable for operation close to high power components.

IPD - Integrated Passive Device, is a GaAs semiconductor process





ELECTRICAL SPECIFICATIONS¹ AT +25°C

Parameter	F#	Frequency (MHz)	Min.	Typ.	Max.	Unit	
Stop Band	Rejection	DC - F'	—	6.9	—	dB	
		F' - F1	12	14.3	—		
	Frequency Cut-off	F2	—	3.0	—		
	VSWR	DC - F'	—	2.7	—		
		F' - F1	—	2.1	—	:1	
Pass Band	Insertion Loss	F3 - F4	—	1.5	—	dB	
		F4 - F5	—	1.4	—		
	VSWR	F3 - F4	—	1.7	—		:1
		F4 - F5	—	2.4	—		

1. Measured on Mini-Circuits Characterization Test Board TB-883-912+

ABSOLUTE MAXIMUM RATINGS²

Parameter	Ratings
Operating Temperature	-55°C to +105°C
Storage Temperature	-65°C to +150°C
RF Power Input, Passband (F3-F5) ²	1.26 W at +25°C
RF Power Input, Stopband (DC-F3) ³	0.25 W at +25°C

2. Permanent damage may occur if any of these limits are exceeded.

3. Passband rating derates linearly to 0.63 W at 105°C ambient

4. Stopband rating derates linearly to 0.12 W at 105°C ambient

SPECIFICATION DEFINITION

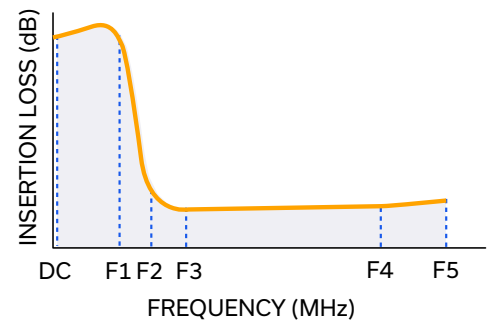



MMIC REFLECTIONLESS

High Pass Filter

XHF2-912+

Mini-Circuits

50Ω 9.1 to 30 GHz

SIMPLIFIED SCHEMATIC AND PAD DESCRIPTION

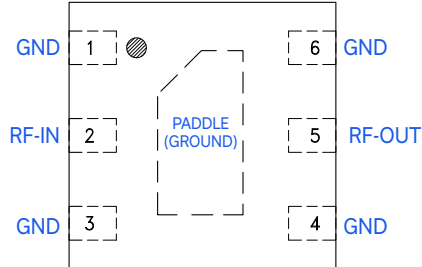
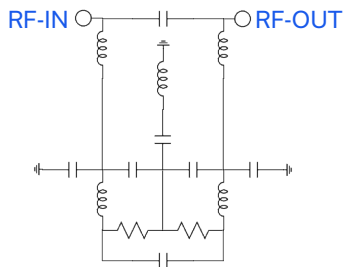

Function	Pad Number	Description
RF-IN	2	RF Input Pad
RF-OUT	5	RF Output Pad
GND	1,3,4,6, Paddle	Connected to ground externally

PRODUCT MARKING

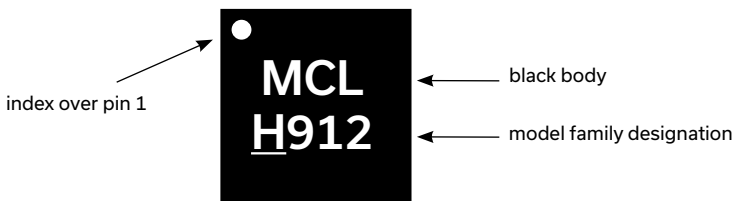

Marking may contain other features or characters for internal lot control





MMIC REFLECTIONLESS

High Pass Filter

XHF2-912+

Mini-Circuits

50Ω 9.1 to 30 GHz

TYPICAL PERFORMANCE DATA AT +25°C

Frequency (MHz)	Insertion Loss (dB)	VSWR (:1)
100	6.98	2.65
500	8.17	2.54
1000	11.63	2.27
1500	16.67	1.99
2500	20.25	1.56
3000	19.81	1.42
4000	26.85	1.30
7100	14.40	1.75
8200	3.04	1.18
9100	1.37	1.10
12000	0.75	1.50
18000	0.40	1.06
20000	0.40	1.11
23000	0.98	2.12
26000	0.73	1.74
30000	1.22	2.11

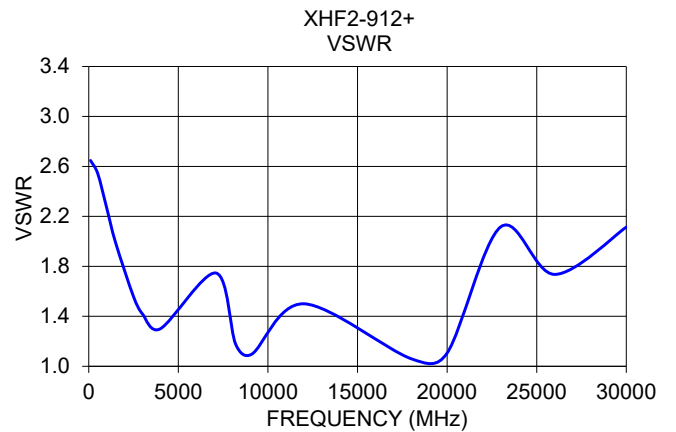
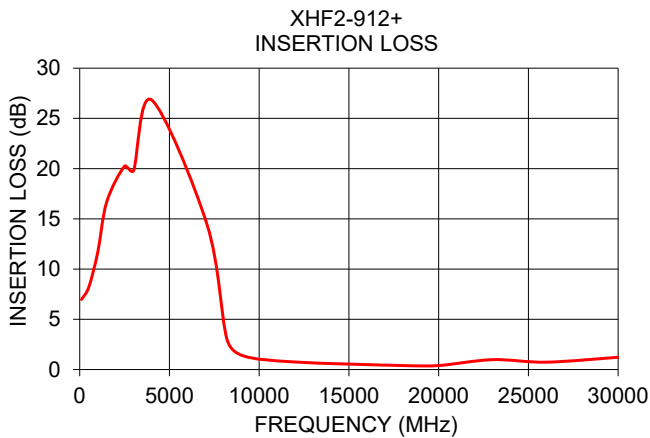



MMIC REFLECTIONLESS

High Pass Filter

XHF2-912+

50Ω 9.1 to 30 GHz

ADDITIONAL DETAILED TECHNICAL INFORMATION IS AVAILABLE ON OUR DASH BOARD. TO ACCESS [CLICK HERE](#)

Performance Data & Graphs	Data Graphs S-Parameter (S2P Files) Data Set (.zip file)
Case Style	MC1630-1 Plastic package, exposed paddle lead finish: matte-tin
Tape & Reel Standard quantities available on reel	F66 7" reels with 20, 50, 100, 200, 500, 1000, 2000 or 3000 devices
Suggested Layout for PCB Design	PL-499
Evaluation Board	TB-883-912+ (without connectors) TB-883-912C+ (with connectors) B20-118-F1+ connector sold separately
Environmental Ratings	ENV82

ESD RATING

Human body model (HBM): Class 1A (250 to <500 V) in accordance with ANSI/ESD 5.1-2001

NOTES

- A. Performance and quality attributes and conditions not expressly stated in this specification document are intended to be excluded and do not form a part of this specification document.
- B. Electrical specifications and performance data contained in this specification document are based on Mini-Circuit's applicable established test performance criteria and measurement instructions.
- C. The parts covered by this specification document are subject to Mini-Circuits standard limited warranty and terms and conditions (collectively, "Standard Terms"); Purchasers of this part are entitled to the rights and benefits contained therein. For a full statement of the standard terms and the exclusive rights and remedies thereunder, please visit Mini-Circuits' website at www.minicircuits.com/MCLStore/terms.jsp



MMIC Reflectionless High Pass Filter

XHF2-912+

Typical Performance Data

FREQ. (MHz)	INSERTION LOSS			INPUT RETURN LOSS			OUTPUT RETURN LOSS		
	(dB)			(dB)			(dB)		
	@-55°C	@25°C	@+105°C	@-55°C	@+25°C	@+105°C	@-55°C	@+25°C	@+105°C
100	6.96	6.97	7.00	6.90	6.91	6.90	6.89	6.90	6.90
500	8.10	8.16	8.22	7.20	7.22	7.26	7.20	7.23	7.25
1000	11.48	11.62	11.74	8.17	8.22	8.33	8.19	8.25	8.32
1500	16.43	16.65	16.85	9.46	9.61	9.77	9.53	9.69	9.80
2000	20.49	20.64	20.76	11.03	11.30	11.54	11.12	11.42	11.64
2500	20.23	20.23	20.23	12.83	13.24	13.60	12.84	13.35	13.75
3000	19.75	19.80	19.84	14.63	15.23	15.70	14.52	15.24	15.81
3500	21.38	21.51	21.62	16.21	17.00	17.52	15.89	16.71	17.29
4000	26.80	26.83	26.83	17.14	18.08	18.90	16.82	17.67	18.38
4500	27.64	26.87	26.27	17.53	18.47	19.67	17.66	18.50	19.49
5000	19.69	19.60	19.52	17.52	18.04	18.85	18.15	18.70	19.41
5500	16.21	16.39	16.55	16.14	16.30	16.40	16.79	17.04	17.15
6000	15.93	16.38	16.82	13.74	13.93	13.88	14.01	14.31	14.34
6500	21.24	22.31	23.08	11.64	11.95	12.12	11.55	11.97	12.21
7000	18.52	16.94	15.70	11.00	11.51	12.02	10.61	11.18	11.69
7500	8.17	7.86	7.56	13.23	14.04	14.84	12.49	13.19	13.88
8000	3.87	3.90	3.91	19.37	20.21	20.97	18.27	18.74	19.30
8500	2.05	2.19	2.31	29.20	29.35	29.20	27.53	26.82	26.24
9000	1.29	1.46	1.60	31.74	32.27	30.99	29.56	27.44	26.05
9500	0.94	1.11	1.25	26.60	27.28	26.42	24.71	23.64	22.45
10000	0.75	0.92	1.07	23.44	23.81	23.19	21.90	21.12	20.30
10500	0.65	0.82	0.96	21.16	20.90	20.62	19.96	19.11	18.59
11000	0.59	0.77	0.91	19.09	18.19	18.10	18.31	17.21	16.84
11500	0.56	0.75	0.89	17.31	15.92	15.72	16.85	15.44	15.04
12000	0.54	0.75	0.91	15.73	14.13	13.69	15.58	13.97	13.36
12500	0.54	0.76	0.94	14.50	12.99	12.26	14.56	12.99	12.11
13000	0.55	0.75	0.95	13.54	12.39	11.49	13.71	12.45	11.40
13500	0.55	0.73	0.93	12.98	12.34	11.40	13.22	12.44	11.36
14000	0.54	0.69	0.87	12.83	12.74	11.94	13.02	12.79	11.82
14500	0.50	0.63	0.80	13.24	13.67	13.05	13.34	13.67	12.90
15000	0.45	0.57	0.72	14.21	15.06	14.88	14.11	14.97	14.63
15500	0.39	0.52	0.65	15.65	16.92	17.42	15.38	16.76	17.05
16000	0.33	0.47	0.60	17.65	19.47	21.00	17.03	19.06	20.36
16500	0.29	0.43	0.57	20.21	23.10	26.62	19.37	22.52	25.81
17000	0.26	0.41	0.55	23.30	29.09	38.29	22.18	27.98	37.72
17500	0.23	0.40	0.55	29.09	58.44	32.85	27.57	48.18	31.19
18000	0.22	0.40	0.56	41.20	30.69	26.16	44.17	30.73	24.62
18500	0.23	0.40	0.57	25.75	24.98	23.05	26.72	24.74	21.44
19000	0.24	0.41	0.58	21.14	23.24	22.99	21.54	22.70	20.97
19500	0.26	0.41	0.58	19.54	23.83	26.38	19.75	22.96	22.62
20000	0.25	0.40	0.58	20.29	28.29	37.84	20.27	25.96	25.69
20500	0.22	0.40	0.60	25.44	32.66	22.87	25.14	28.74	21.39
21000	0.22	0.44	0.69	30.05	20.75	16.25	33.48	20.48	15.83
21500	0.29	0.54	0.85	18.33	15.35	12.56	19.10	15.39	12.27
22000	0.43	0.69	1.02	13.28	12.05	10.34	13.81	12.17	10.16
22500	0.61	0.85	1.18	10.59	10.06	9.07	10.93	10.16	8.89
23000	0.79	0.98	1.27	9.00	8.91	8.47	9.27	9.01	8.31
23500	0.90	1.06	1.27	8.21	8.41	8.51	8.45	8.53	8.33
24000	0.94	1.05	1.19	7.93	8.44	9.08	8.10	8.52	8.85
24500	0.93	1.00	1.08	7.96	8.76	9.99	8.07	8.80	9.72
25000	0.87	0.91	0.97	8.27	9.43	11.19	8.30	9.45	10.92
25500	0.76	0.82	0.89	8.97	10.40	12.55	8.83	10.34	12.31
26000	0.65	0.73	0.84	9.89	11.65	13.67	9.50	11.41	13.47
26500	0.56	0.67	0.84	11.19	12.97	14.38	10.45	12.51	14.26
27000	0.46	0.63	0.85	13.04	14.56	14.87	11.79	13.83	14.75
27500	0.42	0.64	0.91	15.06	15.81	15.01	13.40	15.07	15.29
28000	0.55	0.84	1.13	16.83	15.77	13.97	15.08	15.72	14.91
28500	0.53	0.77	1.08	16.06	14.53	12.99	14.78	14.39	13.32
29000	0.45	0.78	1.15	16.02	13.36	11.78	15.37	13.37	11.84
29500	0.53	0.93	1.35	13.95	11.28	9.97	14.33	11.55	10.03
30000	0.75	1.22	1.67	11.06	8.93	7.99	11.80	9.30	8.02



P.O. Box 350166, Brooklyn, New York 11235-0003 (718) 934-4500 • Fax (718) 332-4661 For detailed performance specs & shopping online see Mini-Circuits web site
 The Design Engineers Search Engine Provides ACTUAL Data Instantly From MINI-CIRCUITS At: www.minicircuits.com

REV. OR
 XHF2-912+
 1/11/2017
 Page 1 of 1

Typical Performance Curves

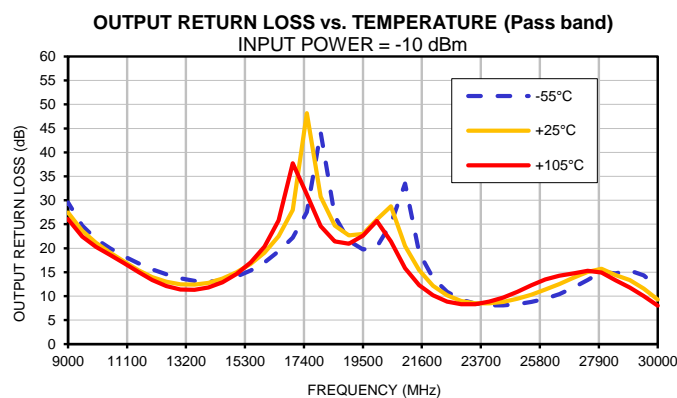
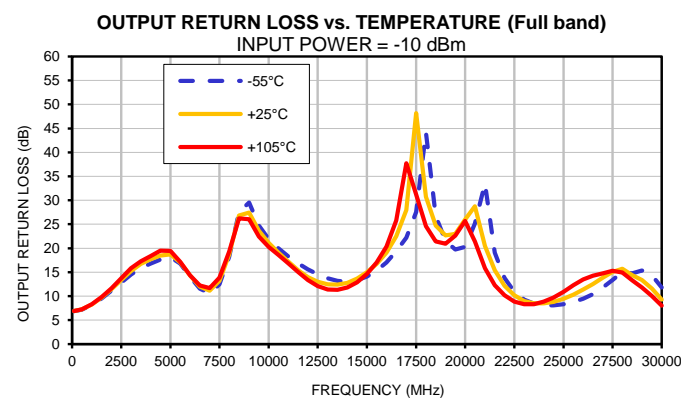
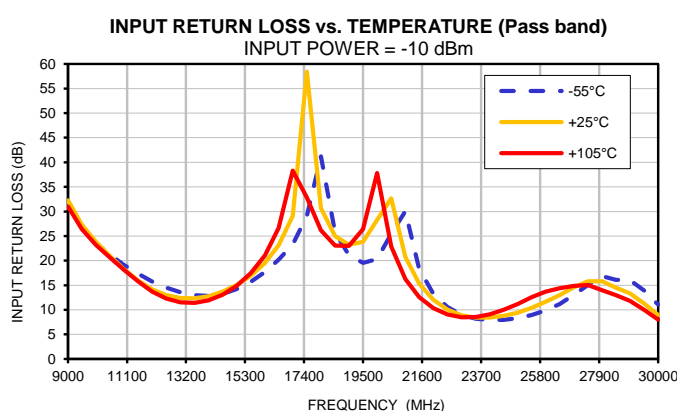
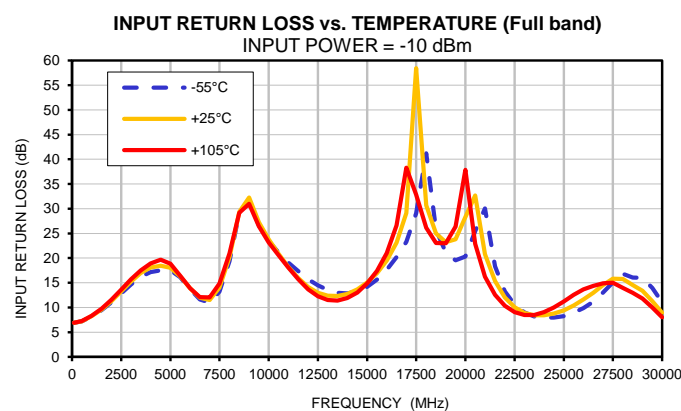
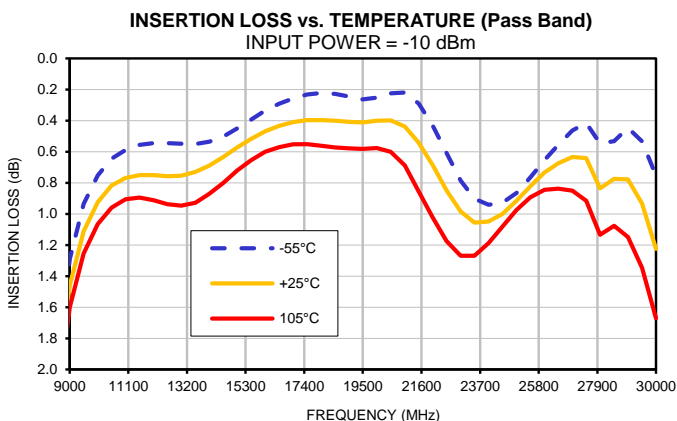
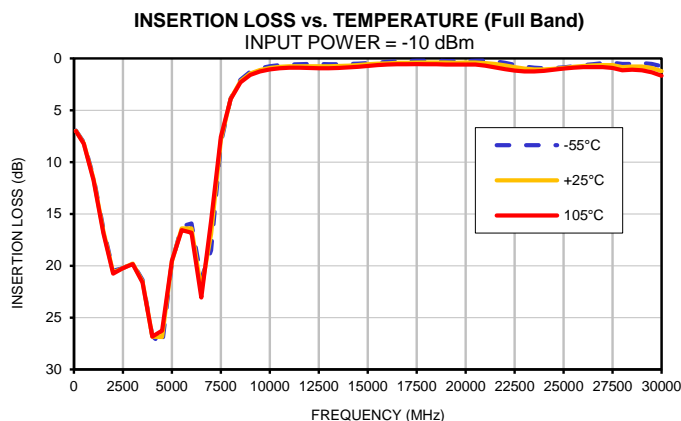

Outline Dimensions

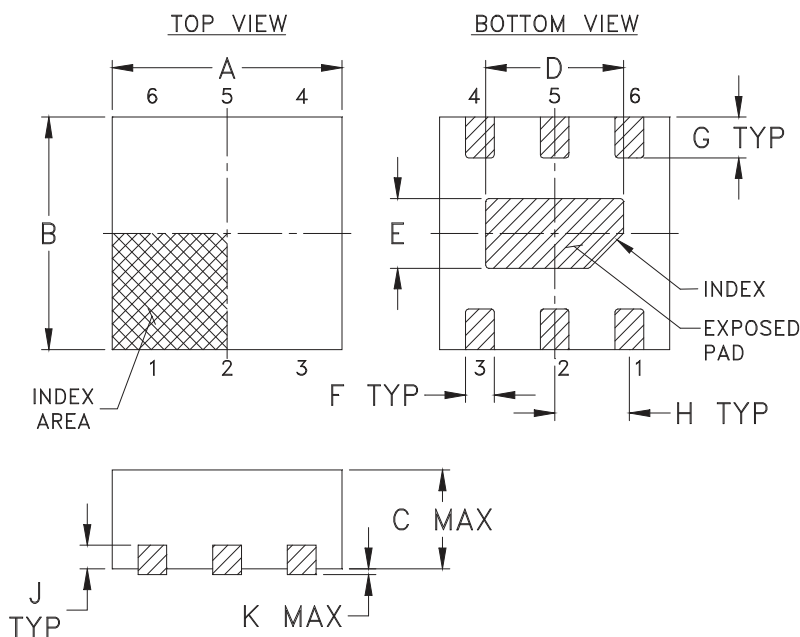

PCB Land Pattern

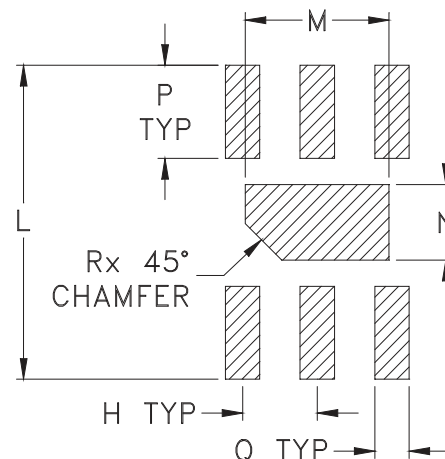

Suggested Layout,
Tolerance to be within $\pm .002$

CASE #.	A	B	C	D	E	F	G	H	J	K	L	M	N	P
MC1630-1	.079 (2.00)	.079 (2.00)	.039 (1.00)	.047 (1.20)	.024 (.60)	.010 (.25)	.014 (.35)	.026 (.65)	.008 (.20)	.002 (.05)	.106 (2.70)	.049 (1.25)	.026 (.65)	.031 (.80)

CASE #.	Q	R	WT, GRAM
MC1630-1	.012 (.30)	.012 (.30)	.006

Dimensions are in inches (mm). Tolerances: 2 Pl. $\pm .01$; 3 Pl. $\pm .005$

Notes:

- Case material: Plastic.
- Termination finish:
For RoHS Case Styles: Tin-Silver over Nickel plated or Matte-Tin plated (See Data sheet).
All models, (+) suffix.
- Lead #1 identifier shall be located in the cross-hatched area shown.
Identifier may be either a molded or marked feature.



P.O. Box 350166, Brooklyn, New York 11235-0003 (718) 934-4500 Fax (718) 332-4661 For detailed performance specs & shopping online see Mini-Circuits web site



The Design Engineers Search Engine Provides ACTUAL Data Instantly From MINI-CIRCUITS At: www.minicircuits.com

RF/IF MICROWAVE COMPONENTS

Tape & Reel Packaging TR-F66



Tape Width, mm	Device Cavity Pitch, mm	Reel Size, inches	Devices per Reel see note	
8	4	7	Small quantity standard	20
				50
				100
				200
				500
		7	Standard	1000, 2000, 3000

Note: Please consult individual model data sheet to determine device per reel availability.

Mini-Circuits carrier tape materials provide protection from ESD (Electro-Static Discharge) during handling and transportation. Tapes are static dissipative and comply with industry standards EIA-481/EIA-541.

Go to: www.minicircuits.com/pages/pdfs/tape.pdf

Mini-Circuits®

INTERNET <http://www.minicircuits.com>

P.O. Box 350166, Brooklyn, New York 11235-0003 (718) 934-4500 Fax (718) 332-4661

Distribution Centers NORTH AMERICA 800-654-7949 • 417-335-5935 • Fax 417-335-5945 • EUROPE 44-1252-832600 • Fax 44-1252-837010

Mini-Circuits ISO 9001 & ISO 14001 Certified

THIRD ANGLE PROJECTION

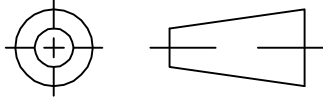

REVISIONS

REV	ECN No.	DESCRIPTION	DATE	DR	AUTH
OR	M160396	NEW RELEASE	02/23/17	GF	RS

SUGGESTED MOUNTING CONFIGURATION FOR MC1630-1 CASE STYLE, "06FL03" PIN CODE

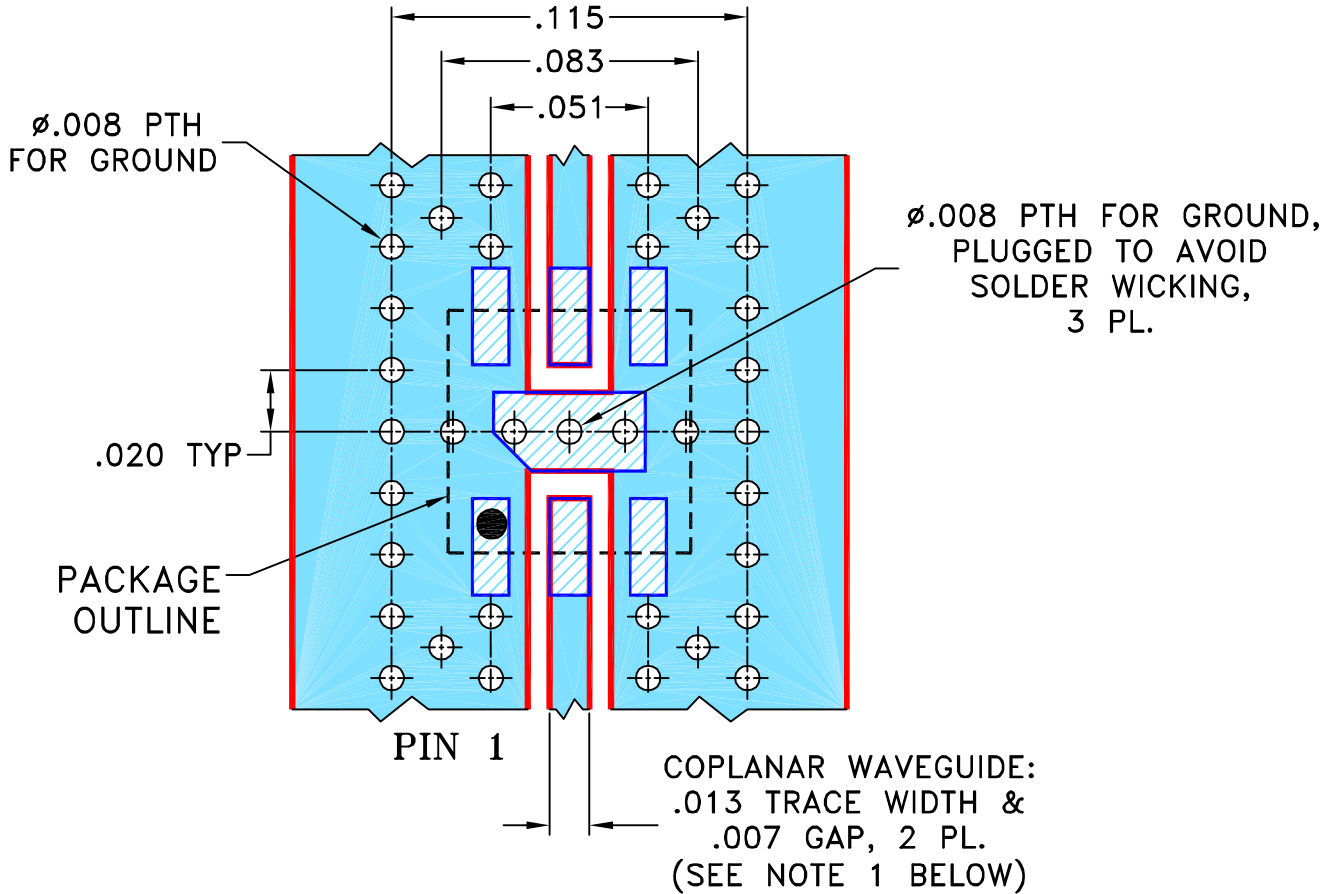

NOTES:

1. COPLANAR WAVEGUIDE IS SHOWN FOR ROGERS R04350B WITH DIELECTRIC THICKNESS .0066" ± .0007"; COPPER: 1/2 OZ. EACH SIDE. FOR OTHER MATERIALS TRACE WIDTH MAY NEED TO BE MODIFIED.
2. BOTTOM SIDE OF THE PCB IS CONTINUOUS GROUND PLANE.

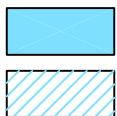

DENOTES PCB COPPER LAYOUT WITH SMOBC (SOLDER MASK OVER BARE COPPER)
 DENOTES COPPER LAND PATTERN FREE OF SOLDER MASK

UNLESS OTHERWISE SPECIFIED	INITIALS	DATE
DRAWN	GF	02/20/17
CHECKED	ITG	02/22/17
APPROVED	RS	02/23/17

Mini-Circuits®
 THIS DOCUMENT AND ITS CONTENTS ARE THE PROPERTY OF MINI-CIRCUITS. EXCEPT FOR USE EXPRESSLY GRANTED, IN WRITING, TO ITS VENDORS, VENDEE AND THE UNITED STATES GOVERNMENT, MINI-CIRCUITS RESERVES ALL PROPRIETARY DESIGN, USE, MANUFACTURING AND REPRODUCTION RIGHTS THERETO. THESE CONTENTS SHALL NOT BE USED, DUPLICATED OR DISCLOSED TO ANY OUTSIDE PARTY, IN WHOLE OR IN PART, WITHOUT WRITTEN PERMISSION OF MINI-CIRCUITS.
 ASHEETA1.DWG REV:A DATE:01/12/95

Mini-Circuits®
 13 Neptune Avenue
 Brooklyn NY 11235

PL, 06FL03, MC1630-1,
 TB-883-XX+

SIZE A	CODE IDENT 15542	DRAWING NO: 98-PL-499	REV: OR
FILE: 98PL499	SCALE: 16:1	SHEET: 1 OF 1	

Evaluation Board and Circuit

To be used with Mini-Circuits 50 Ohm 2.92 connectors B20-118-F1+.
Connectors are sold separately.

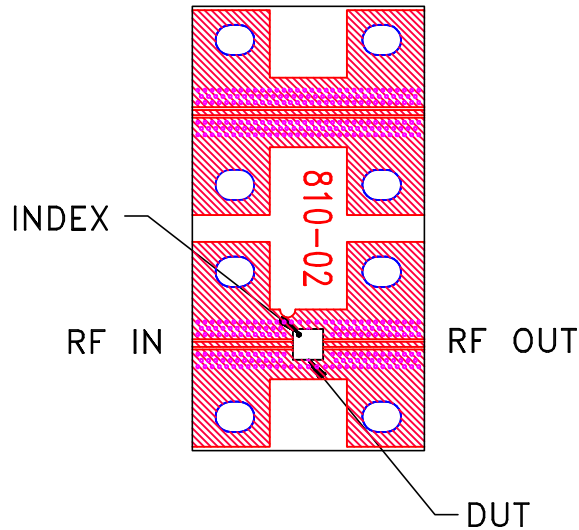

TB-883-912+

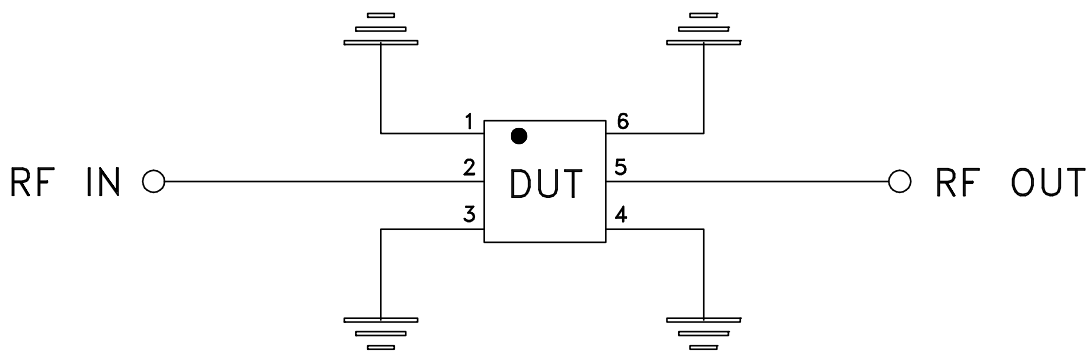

Schematic Diagram

Note:

PCB Material: R04350 or equivalent,
Dielectric Constant=3.5, Thickness=.0066 inch.

 **Mini-Circuits®**

Evaluation Board and Circuit

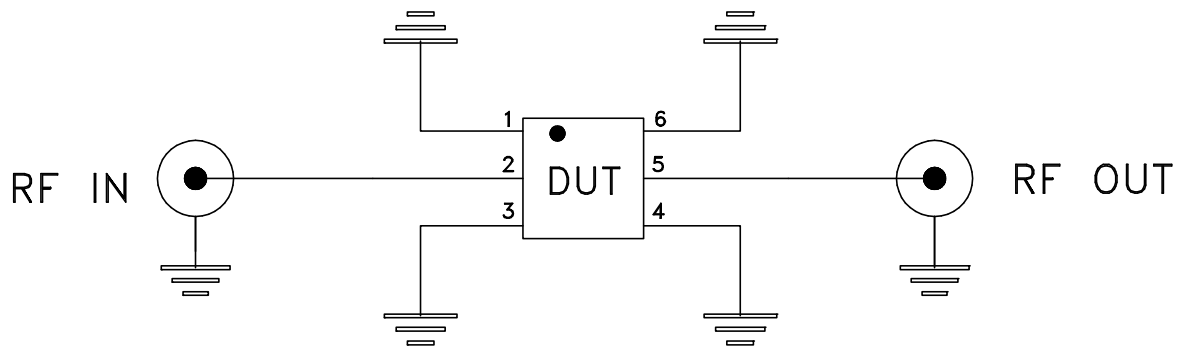
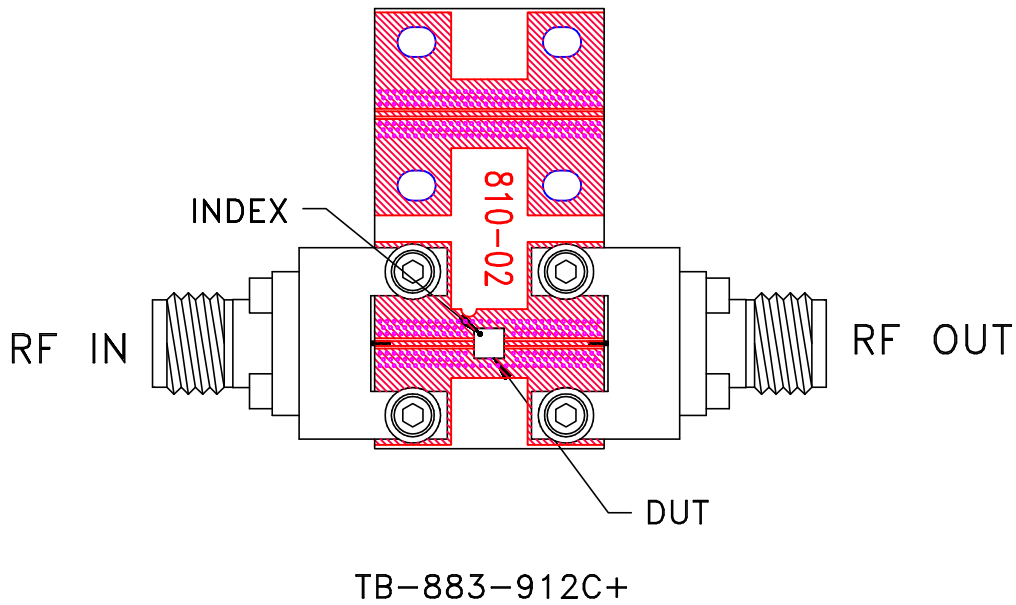

Schematic Diagram

Notes:

1. 50 Ohm 2.92mm Female end launch connectors.
2. PCB Material: R04350 or equivalent,
Dielectric Constant=3.5, Thickness=.0066 inch.

 **Mini-Circuits®**



All Mini-Circuits products are manufactured under exacting quality assurance and control standards, and are capable of meeting published specifications after being subjected to any or all of the following physical and environmental test.

Specification	Test/Inspection Condition	Reference/Spec
Operating Temperature	-55° to 105°C Ambient Environment	Individual Model Data Sheet
Storage Temperature	-65° to 150° C Ambient Environment	Individual Model Data Sheet
Autoclave	15 psig, 100% RH, 121°C, 96 hours	JESD22-A102-C, Condition C
Temperature Cycling	-65° to 150°C, 100 cycles	JESD22-A104
Temperature Humidity	85°C/ 85% RH, 168 hours	JESD22-113
Solder Reflow Heat	Sn-Pb Eutetic Process: 240°C peak Pb-Free Process: 260°C peak	J-STD-020, Table 4-1, 4-2 and 5-2; Figure 5-1
Moisture Sensitivity: Level 1	Bake at 125°C for 24 hours Soak at 85°C/85% RH for 168 hours, Reflow 3 cycles at 240°C peak (Non-RoHS) or 260°C (RoHS)	J-STD-020C
Solderability	10X magnification, 95% coverage	JESD22-B102, Method 1: Dip and Look Test
Marking Resistance to Solvents	Isopropyl alcohol + mineral spirits at 25°C; terpene defluxer at 25°C; distilled water + proylene glycol monomethyl ether + monoethanolamine at 63°C to 70°C	MIL-STD-202, Method 215