

DC Pass, High Power

Power Splitter/Combiner ZC2PD-V24443+

2 Way-0° 50Ω 24000 to 44000 MHz

The Big Deal

- Ultra wideband, 24 to 44 GHz
- Low insertion loss, 0.9 dB typ.
- High Isolation, 30 dB typ.
- 16W power handling
- Low amplitude unbalance, 0.04 dB typ.



CASE STYLE: UU2624-6

Product Overview

Mini-Circuits' ZC2PD-V24443+ is an ultra wideband 2-way 0° splitter/combiner providing coverage from 24 to 44 GHz, supporting a wide range of applications including 5G, V-Band, instrumentation and many more. This model provides 16W power handling as a splitter and very low insertion loss across the entire operating frequency range, minimizing power dissipation and delivering excellent signal power transmission from input to output. The ZC2PD-V24443+ comes housed in a case measuring 1.06 x 0.85 x 0.5".

Key Features

Feature	Advantages
Ultra-wideband, 24 to 44 GHz	Extremely wide frequency range supports many broadband applications in a single model. Ideal for use in wideband instrumentation
Low insertion loss, 0.9 dB typ. at 34 GHz	The combination of 16W power handling and low insertion loss makes this model a suitable candidate for distributing signals while maintaining excellent transmission of signal power.
High isolation, 35.2 dB typ. at 34 GHz	Minimizes interference between ports.
High power handling: • 16W as a splitter at 25°C	The ZC2PD-V24443+ is suitable for systems with a wide range of power requirements.
Low amplitude unbalance, 0.04 dB typ.	Produces nearly equal output signals, ideal for parallel path and multichannel systems.
DC Passing, 389mA	Supports applications where DC power is needed to pass through the RF line.

Notes

- A. Performance and quality attributes and conditions not expressly stated in this specification document are intended to be excluded and do not form a part of this specification document.
B. Electrical specifications and performance data contained in this specification document are based on Mini-Circuit's applicable established test performance criteria and measurement instructions.
C. The parts covered by this specification document are subject to Mini-Circuits standard limited warranty and terms and conditions (collectively, "Standard Terms"); Purchasers of this part are entitled to the rights and benefits contained therein. For a full statement of the Standard Terms and the exclusive rights and remedies thereunder, please visit Mini-Circuits' website at www.minicircuits.com/MCLStore/terms.jsp



DC Pass, High Power Power Splitter/Combiner

ZC2PD-V24443+

2 Way-0° 50Ω 24000 to 44000 MHz

Maximum Ratings

Operating Temperature	-55°C to 100°C
Storage Temperature	-55°C to 100°C
Power Input (as a splitter)	16W* max.
Internal Dissipation	0.2W max.
DC Current	389mA

Permanent damage may occur if any of these limits are exceeded.
* Derate linearly to 7.6W at 100°C

Coaxial Connections

Sum Port	S
Port 1	1
Port 2	2

Outline Drawing

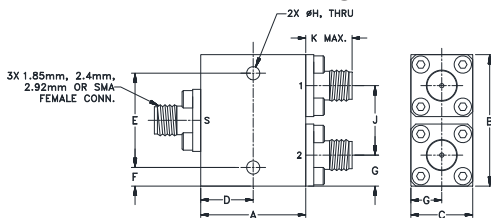

Outline Dimensions (inch/mm)

A	B	C	D	E	F	G
.85	1.06	.50	.425	.760	.150	.25
21.59	26.92	12.70	10.80	19.30	3.81	6.35
H	J	K				wt
.106	.56	.43				grams
2.7	14.22	11				45

Electrical Schematic

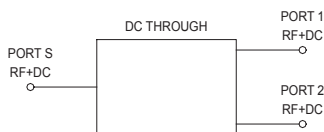

Features

- Ultra wideband, 24000 - 44000 MHz
- Low insertion loss, 0.9 dB typ.
- Low amplitude unbalance, 0.04 dB typ.
- Excellent VSWR, 1.16:1 typ.
- High isolation, 30 dB typ.

Applications

- 5G
- Fixed satellite
- Space research
- Mobile



Generic photo used for illustration purposes only

CASE STYLE: UU2624-6

Connectors Model
2.4mm-Fem ZC2PD-V24443+

+RoHS Compliant

The +Suffix identifies RoHS Compliance. See our web site for RoHS Compliance methodologies and qualifications

Electrical Specifications at 25°C

Parameter	Frequency (MHz)	Min.	Typ.	Max.	Unit
Frequency Range		24000		44000	MHz
Insertion Loss Above 3.0 dB	24000-44000	—	0.9	1.6	dB
Isolation	24000-44000	18	30	—	dB
Amplitude Unbalance	24000-44000	—	±0.04	±0.4	dB
Phase Unbalance	24000-44000	—	±1.2	±5	Deg.
VSWR (Port S)	24000-44000	—	1.16	1.7	:1
VSWR (Port 1-2)	24000-44000	—	1.17	1.7	:1

Typical Performance Data

Frequency (MHz)	Total Loss ¹ (dB)		Amplitude Unbalance (dB)	Isolation (dB)	Phase Unbalance (deg.)	VSWR S	VSWR 1	VSWR 2
	S-1	S-2						
24000	3.72	3.66	0.05	26.13	1.33	1.37	1.33	1.27
25000	3.73	3.67	0.06	28.70	1.40	1.38	1.31	1.28
26000	3.63	3.59	0.04	29.93	1.43	1.15	1.14	1.15
27000	3.65	3.61	0.04	27.62	1.52	1.17	1.07	1.06
28000	3.71	3.67	0.04	25.20	1.71	1.28	1.22	1.17
29000	3.71	3.64	0.08	23.98	1.72	1.15	1.25	1.16
30000	3.72	3.63	0.09	24.59	1.58	1.08	1.25	1.15
32000	3.77	3.72	0.05	33.42	1.37	1.21	1.26	1.19
34000	3.82	3.82	0.00	35.28	1.77	1.27	1.21	1.31
36000	3.79	3.74	0.05	35.18	2.04	1.02	1.05	1.06
38000	3.90	3.83	0.08	23.95	2.06	1.24	1.15	1.14
40000	3.99	3.91	0.08	25.51	1.84	1.34	1.35	1.26
42000	3.96	3.93	0.03	42.87	2.01	1.20	1.17	1.23
44000	4.02	3.93	0.09	26.06	2.24	1.23	1.15	1.08

1. Total Loss = Insertion Loss + 3dB splitter theoretical loss.

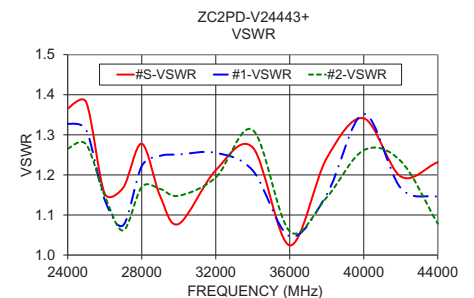
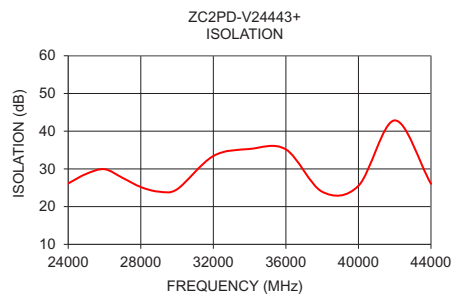
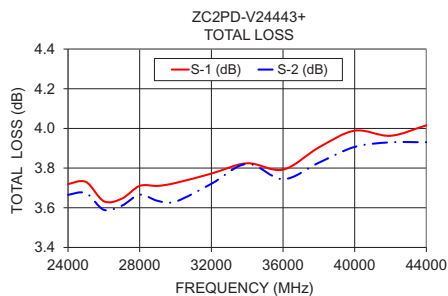

Notes

- Performance and quality attributes and conditions not expressly stated in this specification document are intended to be excluded and do not form a part of this specification document.
- Electrical specifications and performance data contained in this specification document are based on Mini-Circuit's applicable established test performance criteria and measurement instructions.
- The parts covered by this specification document are subject to Mini-Circuit's standard limited warranty and terms and conditions (collectively, "Standard Terms"); Purchasers of this part are entitled to the rights and benefits contained therein. For a full statement of the Standard Terms and the exclusive rights and remedies thereunder, please visit Mini-Circuit's website at www.minicircuits.com/WCLStore/terms.jsp



www.minicircuits.com P.O. Box 350166, Brooklyn, NY 11235-0003 (718) 934-4500 sales@minicircuits.com

REV. OR
ECO-006047
ZC2PD-V24443+
GY/CP/AM
210201
Page 2 of 2

2 Way-0° Power Splitter/Combiner

ZC2PD-V24443+

Typical Performance Data

TEST CONDITIONS: INPUT POWER = 0 dBm @ Temperature = +25°C

FREQUENCY (MHz)	TOTAL LOSS ¹ (dB)		AMPLITUDE UNBALANCE (dB)	ISOLATION (dB) 1-2	PHASE UNBALANCE (Deg)	FREQUENCY (MHz)	VSWR (:1)		
	S-1	S-2					S	1	2
23000	3.62	3.55	0.07	24.34	1.28	23000	1.15	1.29	1.23
23500	3.67	3.61	0.06	25.17	1.30	23500	1.26	1.30	1.24
24000	3.72	3.66	0.05	26.13	1.33	24000	1.37	1.33	1.27
24500	3.74	3.69	0.06	27.37	1.38	24500	1.41	1.33	1.28
25000	3.73	3.67	0.06	28.70	1.40	25000	1.38	1.31	1.28
25500	3.68	3.63	0.05	29.85	1.41	25500	1.28	1.24	1.23
26000	3.63	3.59	0.04	29.93	1.43	26000	1.15	1.14	1.15
26500	3.62	3.58	0.04	29.10	1.47	26500	1.08	1.03	1.06
27000	3.65	3.61	0.04	27.62	1.52	27000	1.17	1.07	1.06
27500	3.69	3.65	0.04	26.22	1.61	27500	1.25	1.16	1.13
28000	3.71	3.67	0.04	25.20	1.71	28000	1.28	1.22	1.17
28500	3.72	3.66	0.06	24.35	1.75	28500	1.24	1.25	1.18
29000	3.71	3.64	0.08	23.98	1.72	29000	1.15	1.25	1.16
29500	3.71	3.62	0.09	24.03	1.65	29500	1.03	1.24	1.15
30000	3.72	3.63	0.09	24.59	1.58	30000	1.08	1.25	1.15
30500	3.75	3.66	0.09	25.76	1.50	30500	1.16	1.27	1.16
31000	3.77	3.69	0.08	27.78	1.43	31000	1.21	1.29	1.17
31500	3.77	3.71	0.06	30.31	1.38	31500	1.23	1.28	1.18
32000	3.77	3.72	0.05	33.42	1.37	32000	1.21	1.26	1.19
32500	3.77	3.73	0.04	36.04	1.39	32500	1.20	1.22	1.21
33000	3.78	3.76	0.03	36.23	1.52	33000	1.20	1.21	1.24
33500	3.80	3.78	0.01	35.73	1.61	33500	1.23	1.20	1.28
34000	3.82	3.82	0.00	35.28	1.77	34000	1.27	1.21	1.31
34500	3.83	3.82	0.01	37.07	1.91	34500	1.27	1.20	1.30
35000	3.81	3.80	0.02	42.60	2.00	35000	1.22	1.17	1.25
35500	3.79	3.76	0.03	45.67	2.05	35500	1.12	1.12	1.16
36000	3.79	3.74	0.05	35.18	2.04	36000	1.02	1.05	1.06
36500	3.83	3.77	0.06	29.54	2.05	36500	1.14	1.06	1.04
37000	3.87	3.81	0.07	26.67	2.05	37000	1.24	1.13	1.12
37500	3.91	3.84	0.07	24.87	2.07	37500	1.29	1.16	1.16
38000	3.90	3.83	0.08	23.95	2.06	38000	1.24	1.15	1.14
38500	3.87	3.80	0.08	23.50	2.01	38500	1.14	1.12	1.10
39000	3.87	3.79	0.08	23.64	1.98	39000	1.11	1.17	1.10
39500	3.92	3.83	0.09	24.49	1.90	39500	1.22	1.27	1.16
40000	3.99	3.91	0.08	25.51	1.84	40000	1.34	1.35	1.26
40500	4.04	3.96	0.08	27.20	1.87	40500	1.40	1.38	1.31
41000	4.04	3.98	0.06	29.82	1.91	41000	1.40	1.36	1.33
41500	4.01	3.96	0.05	34.02	1.98	41500	1.32	1.27	1.30
42000	3.96	3.93	0.03	42.87	2.01	42000	1.20	1.17	1.23
42500	3.92	3.88	0.04	41.70	2.06	42500	1.07	1.06	1.15
43000	3.92	3.87	0.05	32.23	2.16	43000	1.06	1.05	1.07
43500	3.97	3.90	0.07	28.10	2.23	43500	1.17	1.12	1.02
44000	4.02	3.93	0.09	26.06	2.24	44000	1.23	1.15	1.08
44500	4.05	3.95	0.10	24.71	2.17	44500	1.26	1.15	1.10
45000	4.04	3.94	0.10	24.15	2.14	45000	1.22	1.13	1.10
45500	4.05	3.96	0.09	24.43	1.99	45500	1.13	1.13	1.07

¹Total Loss = Insertion Loss + 3dB Splitter Loss



P.O. Box 350166, Brooklyn, New York 11235-0003 (718) 934-4500 • Fax (718) 332-4661 For detailed performance specs & shopping online see Mini-Circuits web site



The Design Engineers Search Engine Provides ACTUAL Data Instantly From MINI-CIRCUITS At: www.minicircuits.com

IF/RF MICROWAVE COMPONENTS

REV. OR
ZC2PD-V24443+
2/15/2021

Page 1 of 3

2 Way-0° Power Splitter/Combiner

ZC2PD-V24443+

Typical Performance Data

TEST CONDITIONS: INPUT POWER =0 dBm @Temperature = -55°C

FREQUENCY (MHz)	TOTAL LOSS ¹ (dB)		AMPLITUDE UNBALANCE (dB)	ISOLATION (dB) 1-2	PHASE UNBALANCE (Deg)	FREQUENCY (MHz)	VSWR (:1)		
	S-1	S-2					S	1	2
23000	3.58	3.52	0.06	24.32	1.03	23000	1.14	1.28	1.23
23500	3.62	3.57	0.06	24.93	1.07	23500	1.25	1.29	1.24
24000	3.68	3.62	0.05	25.90	1.10	24000	1.36	1.32	1.26
24500	3.70	3.65	0.05	27.03	1.14	24500	1.40	1.33	1.28
25000	3.70	3.64	0.06	28.34	1.17	25000	1.38	1.31	1.28
25500	3.65	3.59	0.05	29.16	1.17	25500	1.29	1.24	1.23
26000	3.60	3.55	0.05	29.32	1.18	26000	1.15	1.14	1.15
26500	3.58	3.54	0.04	28.33	1.20	26500	1.08	1.03	1.06
27000	3.61	3.57	0.04	26.89	1.24	27000	1.17	1.07	1.06
27500	3.65	3.61	0.04	25.74	1.32	27500	1.26	1.16	1.13
28000	3.67	3.62	0.05	24.67	1.43	28000	1.28	1.23	1.17
28500	3.67	3.61	0.06	23.96	1.48	28500	1.24	1.25	1.17
29000	3.66	3.59	0.08	23.67	1.44	29000	1.14	1.25	1.16
29500	3.67	3.57	0.09	23.89	1.36	29500	1.03	1.25	1.15
30000	3.68	3.58	0.10	24.59	1.25	30000	1.08	1.26	1.15
30500	3.70	3.61	0.09	25.77	1.14	30500	1.17	1.28	1.16
31000	3.72	3.64	0.08	27.95	1.09	31000	1.21	1.29	1.16
31500	3.72	3.66	0.06	30.54	1.03	31500	1.22	1.28	1.17
32000	3.72	3.67	0.05	32.81	1.02	32000	1.20	1.25	1.19
32500	3.73	3.69	0.04	34.72	1.05	32500	1.20	1.23	1.21
33000	3.73	3.71	0.02	35.72	1.17	33000	1.21	1.21	1.25
33500	3.75	3.74	0.01	35.61	1.27	33500	1.24	1.21	1.29
34000	3.77	3.77	0.00	36.10	1.43	34000	1.28	1.22	1.32
34500	3.77	3.77	0.01	40.08	1.58	34500	1.27	1.20	1.31
35000	3.75	3.73	0.01	52.00	1.65	35000	1.20	1.17	1.25
35500	3.73	3.69	0.03	40.59	1.71	35500	1.10	1.11	1.15
36000	3.73	3.68	0.05	33.09	1.70	36000	1.03	1.04	1.05
36500	3.77	3.71	0.06	28.63	1.67	36500	1.16	1.07	1.05
37000	3.81	3.75	0.07	26.22	1.68	37000	1.25	1.13	1.12
37500	3.84	3.77	0.07	24.88	1.68	37500	1.28	1.16	1.16
38000	3.83	3.76	0.07	24.15	1.66	38000	1.22	1.15	1.14
38500	3.80	3.73	0.08	23.88	1.61	38500	1.12	1.13	1.10
39000	3.80	3.72	0.08	24.05	1.58	39000	1.09	1.17	1.10
39500	3.85	3.76	0.08	24.82	1.51	39500	1.21	1.26	1.17
40000	3.91	3.84	0.08	25.74	1.47	40000	1.33	1.34	1.26
40500	3.96	3.89	0.07	27.14	1.49	40500	1.40	1.38	1.31
41000	3.97	3.91	0.06	29.30	1.52	41000	1.40	1.36	1.33
41500	3.94	3.90	0.04	33.38	1.57	41500	1.33	1.28	1.30
42000	3.89	3.85	0.03	41.41	1.60	42000	1.21	1.17	1.24
42500	3.85	3.81	0.04	41.90	1.65	42500	1.08	1.06	1.16
43000	3.85	3.80	0.05	31.88	1.76	43000	1.06	1.05	1.06
43500	3.90	3.83	0.07	27.66	1.82	43500	1.18	1.12	1.03
44000	3.95	3.86	0.08	25.78	1.81	44000	1.25	1.15	1.09
44500	3.97	3.88	0.09	24.57	1.77	44500	1.27	1.15	1.11
45000	3.97	3.87	0.10	24.13	1.70	45000	1.22	1.13	1.10
45500	3.98	3.89	0.08	24.52	1.52	45500	1.12	1.13	1.07

¹Total Loss = Insertion Loss + 3dB Splitter Loss



P.O. Box 350166, Brooklyn, New York 11235-0003 (718) 934-4500 • Fax (718) 332-4661 For detailed performance specs & shopping online see Mini-Circuits web site



The Design Engineers Search Engine Provides ACTUAL Data Instantly From MINI-CIRCUITS At: www.minicircuits.com

IF/RF MICROWAVE COMPONENTS

REV. OR
ZC2PD-V24443+
2/15/2021

Page 2 of 3

2 Way-0° Power Splitter/Combiner

ZC2PD-V24443+

Typical Performance Data

TEST CONDITIONS: INPUT POWER =0 dBm @Temperature = +100°C

FREQUENCY (MHz)	TOTAL LOSS ¹ (dB)		AMPLITUDE UNBALANCE (dB)	ISOLATION (dB) 1-2	PHASE UNBALANCE (Deg)	FREQUENCY (MHz)	VSWR (:1)		
	S-1	S-2					S	1	2
23000	3.73	3.67	0.06	24.29	1.09	23000	1.14	1.26	1.21
23500	3.78	3.72	0.05	25.06	1.15	23500	1.24	1.26	1.22
24000	3.83	3.78	0.05	26.18	1.19	24000	1.33	1.28	1.25
24500	3.85	3.80	0.05	27.48	1.25	24500	1.37	1.29	1.26
25000	3.84	3.79	0.05	28.90	1.28	25000	1.35	1.28	1.25
25500	3.80	3.75	0.05	29.69	1.28	25500	1.26	1.23	1.21
26000	3.77	3.72	0.05	29.49	1.28	26000	1.14	1.14	1.13
26500	3.76	3.72	0.04	28.49	1.29	26500	1.08	1.04	1.06
27000	3.79	3.75	0.04	27.14	1.32	27000	1.16	1.06	1.07
27500	3.82	3.79	0.03	25.95	1.41	27500	1.23	1.14	1.13
28000	3.84	3.81	0.04	24.99	1.53	28000	1.25	1.20	1.16
28500	3.85	3.79	0.05	24.33	1.59	28500	1.20	1.23	1.17
29000	3.85	3.77	0.07	24.06	1.56	29000	1.12	1.23	1.16
29500	3.86	3.77	0.09	24.25	1.47	29500	1.02	1.23	1.15
30000	3.87	3.78	0.09	24.88	1.40	30000	1.07	1.23	1.14
30500	3.89	3.81	0.08	26.06	1.33	30500	1.14	1.23	1.14
31000	3.91	3.84	0.07	27.92	1.31	31000	1.17	1.24	1.15
31500	3.92	3.86	0.06	30.36	1.29	31500	1.19	1.24	1.16
32000	3.92	3.87	0.05	33.09	1.31	32000	1.19	1.22	1.18
32500	3.93	3.88	0.05	36.52	1.35	32500	1.19	1.21	1.19
33000	3.96	3.92	0.04	38.20	1.41	33000	1.20	1.21	1.22
33500	3.96	3.93	0.03	38.29	1.47	33500	1.22	1.21	1.25
34000	3.98	3.96	0.02	37.36	1.56	34000	1.24	1.22	1.27
34500	3.99	3.97	0.02	38.04	1.67	34500	1.23	1.20	1.27
35000	3.98	3.96	0.02	39.40	1.77	35000	1.19	1.16	1.24
35500	3.96	3.94	0.03	38.56	1.85	35500	1.12	1.11	1.18
36000	3.97	3.92	0.04	34.23	1.89	36000	1.03	1.06	1.10
36500	3.99	3.93	0.06	30.43	1.91	36500	1.07	1.05	1.02
37000	4.03	3.96	0.07	27.85	1.92	37000	1.16	1.09	1.05
37500	4.06	3.99	0.08	26.38	1.89	37500	1.21	1.11	1.10
38000	4.07	3.99	0.08	25.38	1.86	38000	1.21	1.11	1.11
38500	4.06	3.99	0.08	24.78	1.82	38500	1.15	1.09	1.09
39000	4.05	3.98	0.07	24.85	1.78	39000	1.10	1.12	1.07
39500	4.08	4.01	0.07	25.17	1.73	39500	1.15	1.19	1.12
40000	4.14	4.06	0.07	25.95	1.75	40000	1.26	1.27	1.21
40500	4.19	4.12	0.07	27.25	1.80	40500	1.34	1.32	1.28
41000	4.21	4.16	0.05	29.48	1.86	41000	1.37	1.33	1.33
41500	4.20	4.16	0.04	33.23	1.93	41500	1.33	1.29	1.31
42000	4.16	4.13	0.04	40.49	1.95	42000	1.22	1.19	1.25
42500	4.13	4.08	0.04	41.49	2.03	42500	1.08	1.09	1.15
43000	4.13	4.07	0.05	32.80	2.13	43000	1.05	1.04	1.04
43500	4.18	4.11	0.07	28.88	2.19	43500	1.16	1.11	1.04
44000	4.22	4.14	0.08	26.62	2.20	44000	1.23	1.15	1.09
44500	4.23	4.14	0.09	25.43	2.14	44500	1.22	1.16	1.09
45000	4.23	4.13	0.10	25.15	2.11	45000	1.16	1.14	1.07
45500	4.24	4.15	0.08	25.37	2.13	45500	1.10	1.13	1.06

¹Total Loss = Insertion Loss + 3dB Splitter Loss



P.O. Box 350166, Brooklyn, New York 11235-0003 (718) 934-4500 • Fax (718) 332-4661 For detailed performance specs & shopping online see Mini-Circuits web site



The Design Engineers Search Engine Provides ACTUAL Data Instantly From MINI-CIRCUITS At: www.minicircuits.com

IF/RF MICROWAVE COMPONENTS

REV. OR
ZC2PD-V24443+
2/15/2021

2 Way-0° Power Splitter/Combiner

ZC2PD-V24443+

Typical Performance Curves

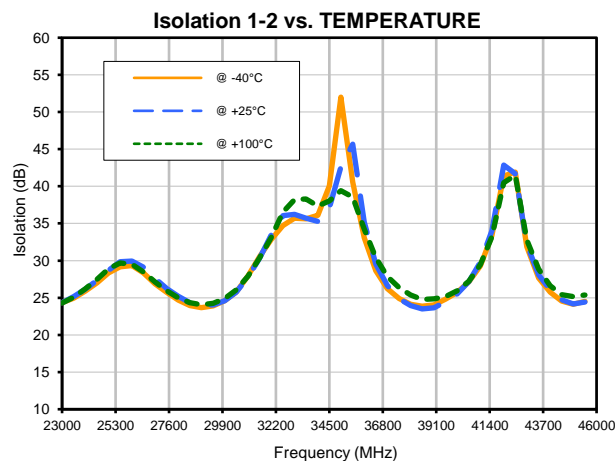
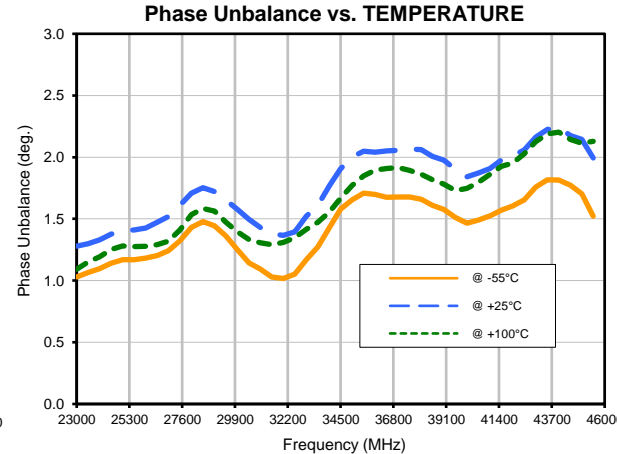
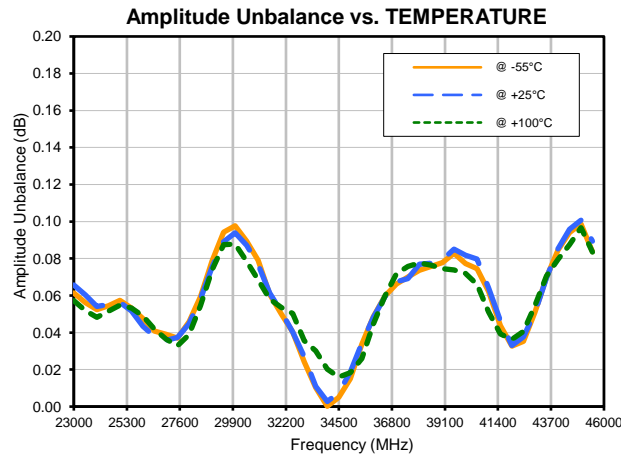
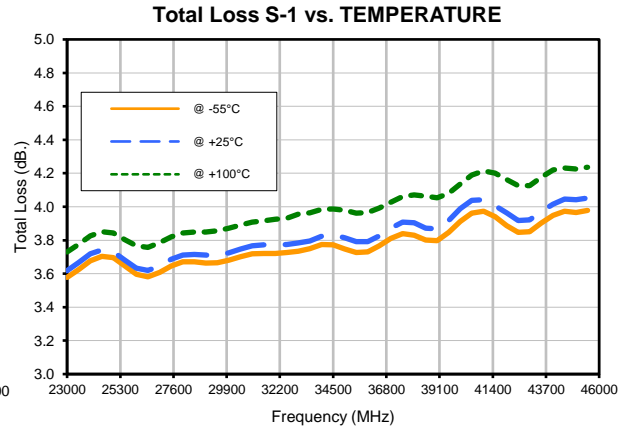
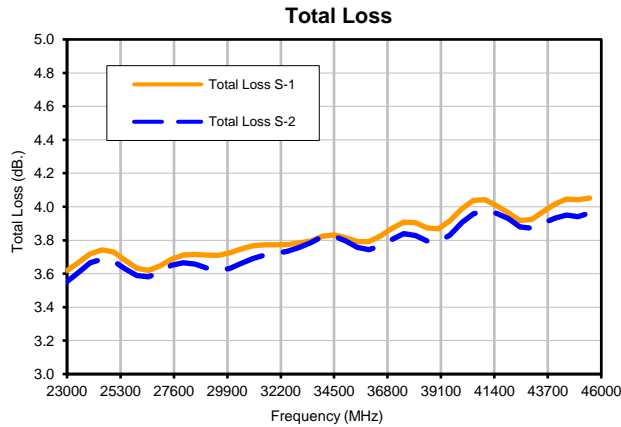

2 Way-0° Power Splitter/Combiner

ZC2PD-V24443+

Typical Performance Curves

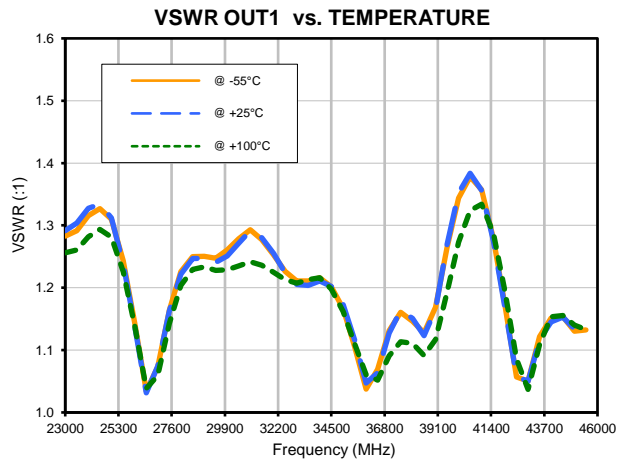
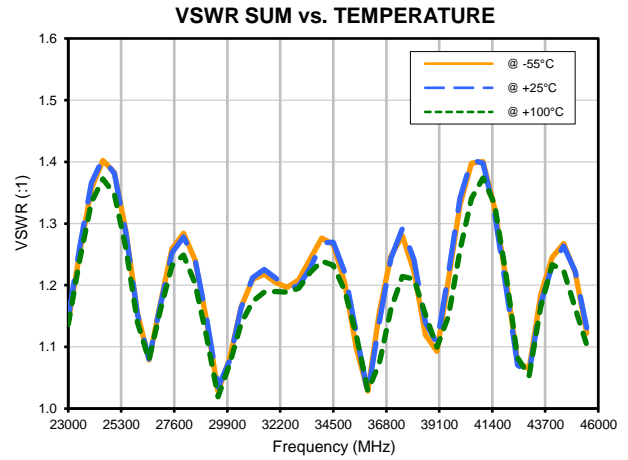
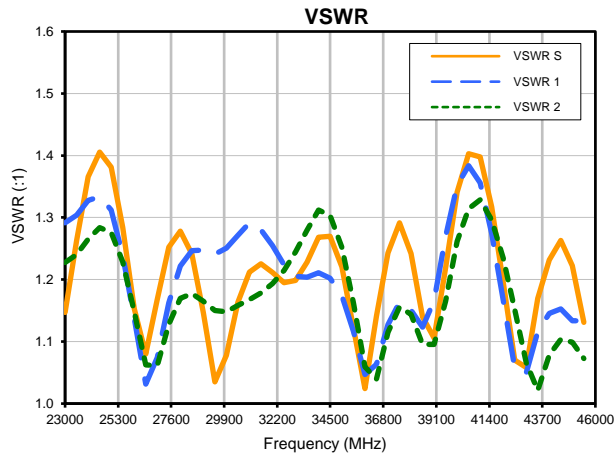

Case Style

UU

Outline Dimensions

UU2624-6

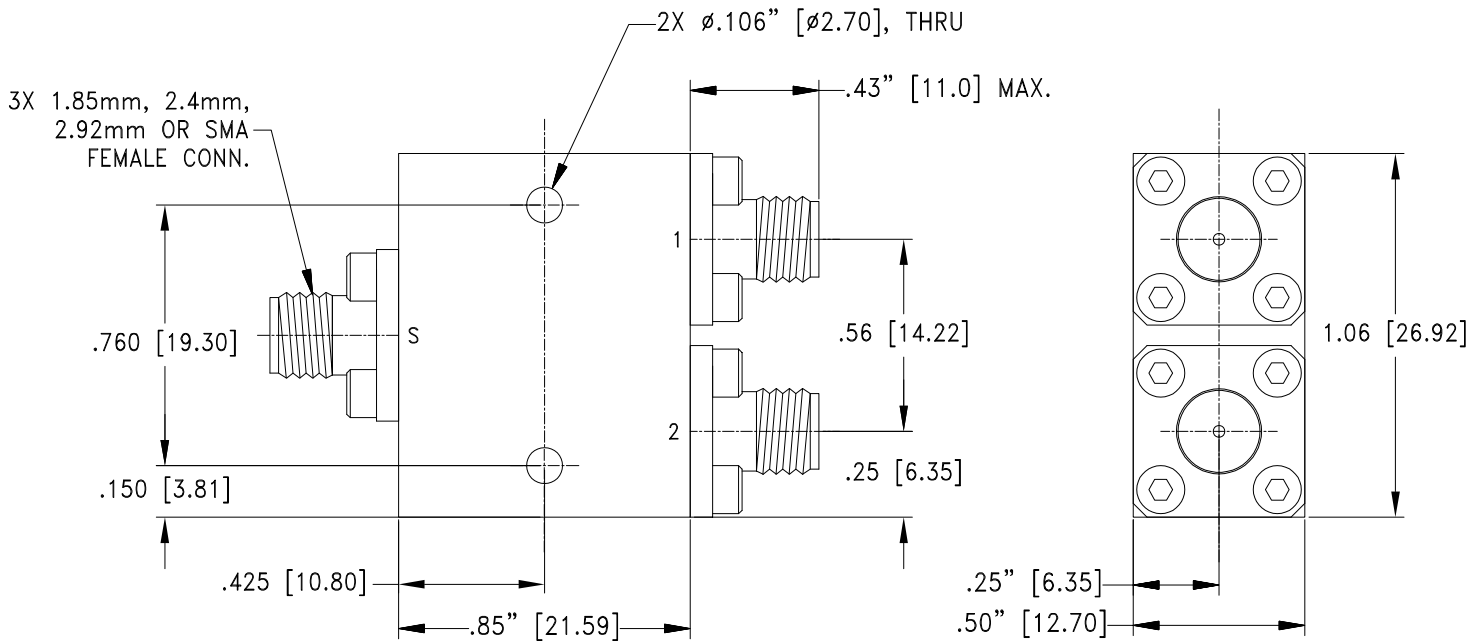

Weight: 35 grams.

Dimensions are in inches (mm). Tolerances: 2 Pl. $\pm .03$; 3 Pl. $\pm .015$

Notes:

1. Case Material: Aluminum Alloy
2. Case Finish:
For RoHS Case Styles: Nickel Plating.

Mini-Circuits®
ISO 9001 ISO 14001 CERTIFIED

ALL NEW
minicircuits.com

P.O. Box 350166, Brooklyn, New York 11235-0003 (718) 934-4500 Fax (718) 332-4661 For detailed performance specs & shopping online see Mini-Circuits web site



The Design Engineers Search Engine Provides ACTUAL Data Instantly From MINI-CIRCUITS At: www.minicircuits.com

RF/IF MICROWAVE COMPONENTS



All Mini-Circuits products are manufactured under exacting quality assurance and control standards, and are capable of meeting published specifications after being subjected to any or all of the following physical and environmental test.

Specification	Test/Inspection Condition	Reference/Spec
Operating Temperature	-55° to 100°C Ambient Environment	Individual Model Data Sheet
Storage Temperature	-55° to 100° C Ambient Environment	Individual Model Data Sheet
Thermal Shock	-55° to 100°C, 25 cycles	MIL-STD-202, Method 107, Condition A-1 except +100°C instead of 85°C
Vibration (High Frequency)	20g peak, 10-2000 Hz, 12 times in each of three perpendicular directions (total 36)	MIL-STD-202, Method 204, Condition D
Mechanical Shock	100g, 6ms sawtooth, 3 shocks each direction 3 axes (total 18)	MIL-STD-202, Method 213, Condition I
Connector Durability	500 mating/unmating cycles	MIL-PRF-39012E, PARAGRAPH 4.6.12