



COAXIAL

High-Power Amplifier

ZHL-20M2G7025+
ZHL-20M2G7025X+

50Ω 20 to 2700 MHz Broadband 25W SMA-Female

KEY FEATURES

- Broadband, 20 to 2700 MHz
- High Gain, 50 dB typ.
- High P1dB, +40 dBm, typ.
- High OIP3, +49 dBm typ.



Generic photo used for illustration purposes only

APPLICATIONS

- Communication Systems
- R&D, Production, and OTA Test Systems
- Test & Measurement Equipment
- General Laboratory Applications

FUNCTIONAL DIAGRAM

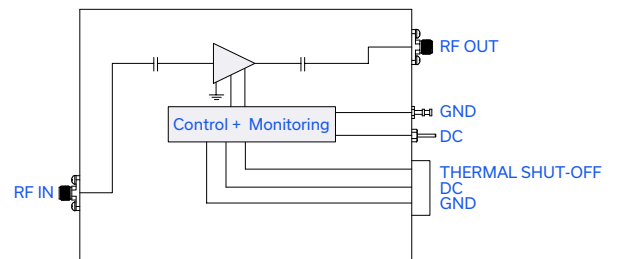

PRODUCT OVERVIEW

The ZHL-20M2G7025(X)+ is a high-power broadband amplifier providing more than 25 W of output power with a typical small signal gain of 50 dB over the 20 to 2700 MHz frequency band. The amplifier uses state-of-the-art semiconductor technology and can be used in a wide range of applications. A single supply voltage ensures ease of operation. The amplifier is made with a rugged aluminum housing and can be supplied with or without a heatsink.

ELECTRICAL SPECIFICATIONS AT $T_{\text{MOUNTING BASE}} = +25^{\circ}\text{C}$, $V_{\text{DS}} = +28\text{ V}$

Parameter	Symbol	Condition	Min.	Typ.	Max.	Units
Frequency Range	f		20		2700	MHz
Small Signal Gain	G_{SS}	$P_{\text{OUT}} = -25\text{ dBm}$	45	50	55	dB
Small Signal Gain Flatness	$G_{\text{SS-FLAT}}$	$P_{\text{OUT}} = -25\text{ dBm}$		± 0.8	± 2.0	dB
Output Power at 1dB compression	$P_{1\text{dB}}$	$P_{\text{OUT-REF}} = +35\text{ dBm}$	+36	+40		dBm
Output Power at 3dB compression	$P_{3\text{dB}}$	$P_{\text{OUT-REF}} = +35\text{ dBm}$	+40	+44		dBm
Output Power at Saturation	P_{SAT}	$P_{\text{OUT-REF}} = +35\text{ dBm}$	+42	+45		dBm
Noise Figure	NF			10		dB
Output Third Order Intercept Point	OIP3	$P_{\text{OUT}} = +30\text{ dBm/ tone}$	+40	+49		dBm
Input Return Loss	I-RL	$P_{\text{OUT}} = -25\text{ dBm}$	7.7	23		dB
Output Return Loss	O-RL	$P_{\text{OUT}} = -25\text{ dBm}$	7.7	10		dB
DC Supply Voltage	V_{DC}		+23	+28	+29	V
Supply Current	I_{DC}	Without fan @ $P_{\text{OUT}} = +44\text{ dBm}$		3.5	5.0	A
		With fan @ $P_{\text{OUT}} = +44\text{ dBm}$		3.9	5.4	





COAXIAL

High-Power Amplifier

ZHL-20M2G7025+
ZHL-20M2G7025X+

Mini-Circuits

50Ω 20 to 2700 MHz Broadband 25W SMA-Female

TYPICAL PERFORMANCE DATA AT $T_{\text{MOUNTINGBASE}} = +25^{\circ}\text{C}$, $V_{\text{DC}} = +28\text{V}$, 50 OHM

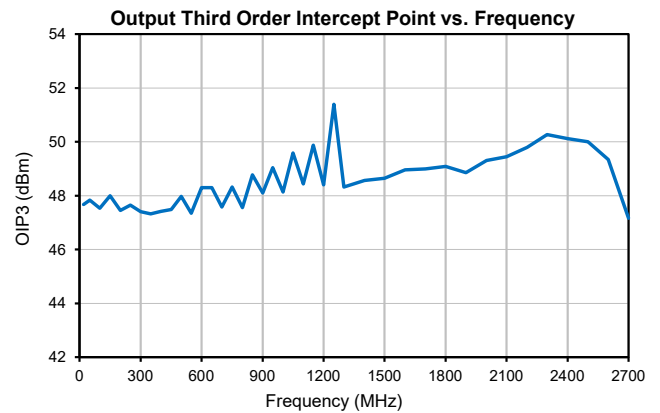
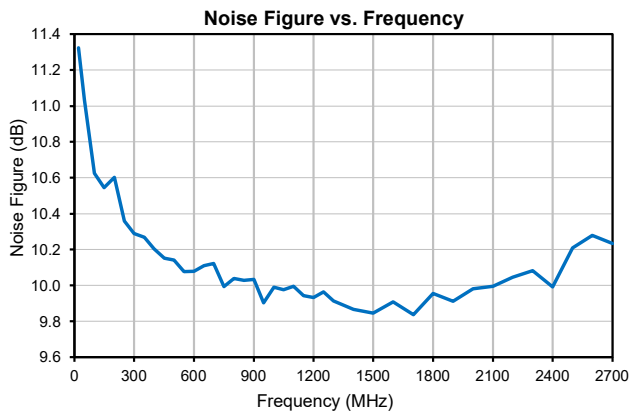
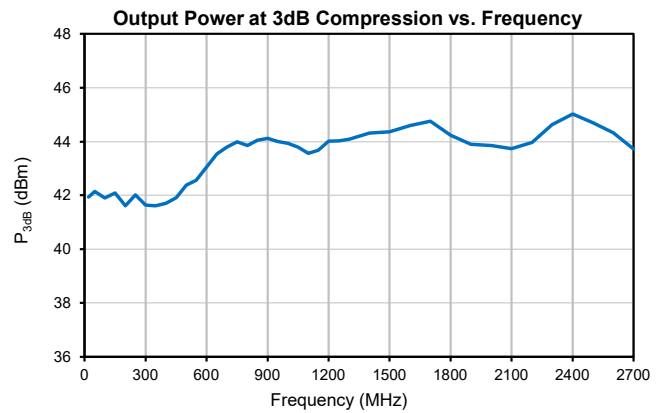
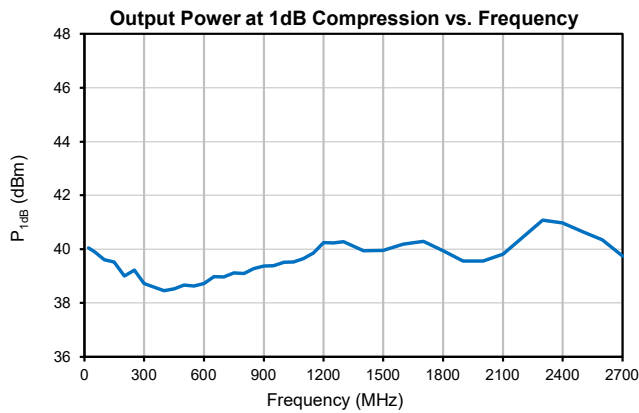
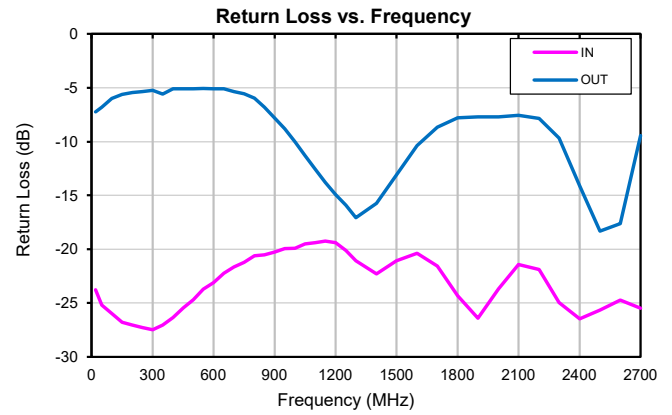
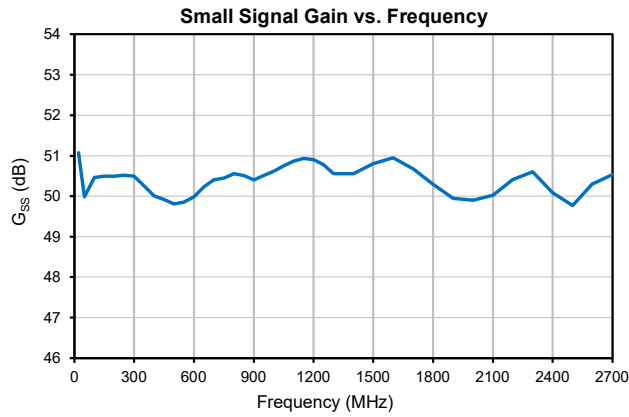



COAXIAL

High-Power Amplifier

ZHL-20M2G7025+
ZHL-20M2G7025X+

Mini-Circuits

50Ω 20 to 2700 MHz Broadband 25W SMA-Female

ABSOLUTE MAXIMUM RATINGS

Parameter	Ratings
Operating Temperature	ZHL-20M2G7025+ $T_{AMBIENT}$: -20 °C to +60 °C
	ZHL-20M2G7025X+ $T_{MOUNTING\ BASE}$: -20 °C to +80 °C
Storage Temperature	-55°C to +100°C
Max Power Dissipation(no fan) = 115 W Max Power Dissipation(with fan) = 125 W	
No damage with an open or short at $P_{OUT} = +42$ dBm CW	
RF Input Power (no damage)	+5 dBm
DC Operating Voltage	± 29.5 V

Permanent damage may occur if any of these limits are exceeded.

D-SUB MALE CONNECTOR PIN CONNECTIONS¹

Pin Function	Label on unit	Pin #
None	N/C1, N/C2, N/C3 N/C4, N/C5	1,2,4,5
<u>Thermal Shut-Off Indication</u> Shut-Off: +2 to +5V Not Shut-Off: 0 to +0.8V	TTL Out	3
DC Input (+)	Vdc	6,7
Ground	GND	8,9

1. Each amplifier will come packaged with an additional D-Sub connector for mating with the amplifier

DETERMINING MAXIMUM THERMAL RESISTANCE OF USERS' EXTERNAL HEAT SINK

$MAXIMUM\ THERMAL\ RESISTANCE = \frac{MAXIMUM\ OPERATING\ CASE\ TEMP - MAXIMUM\ USER\ AMBIENT\ TEMP}{POWER\ DISSIPATION}$
Example: MAXIMUM MOUNTING BASE TEMP = +85 °C (CHECK MAXIMUM RATINGS TABLE FOR THIS VALUE) MAXIMUM USER AMBIENT TEMP = +60 °C (USER DEFINED) POWER DISSIPATION = 98 WATTS (CHECK MAXIMUM RATINGS TABLE FOR THIS VALUE) THEN MAXIMUM ALLOWABLE THERMAL RESISTANCE = 0.15 °C/W





COAXIAL

High-Power Amplifier

ZHL-20M2G7025+
ZHL-20M2G7025X+

Mini-Circuits

50Ω 20 to 2700 MHz Broadband 25W SMA-Female

COAXIAL CONNECTIONS

IN (RF IN)	SMA-Female
OUT (RF OUT)	SMA-Female

CASE STYLE DRAWING WITH HEATSINK (ZHL-20M2G7025+)

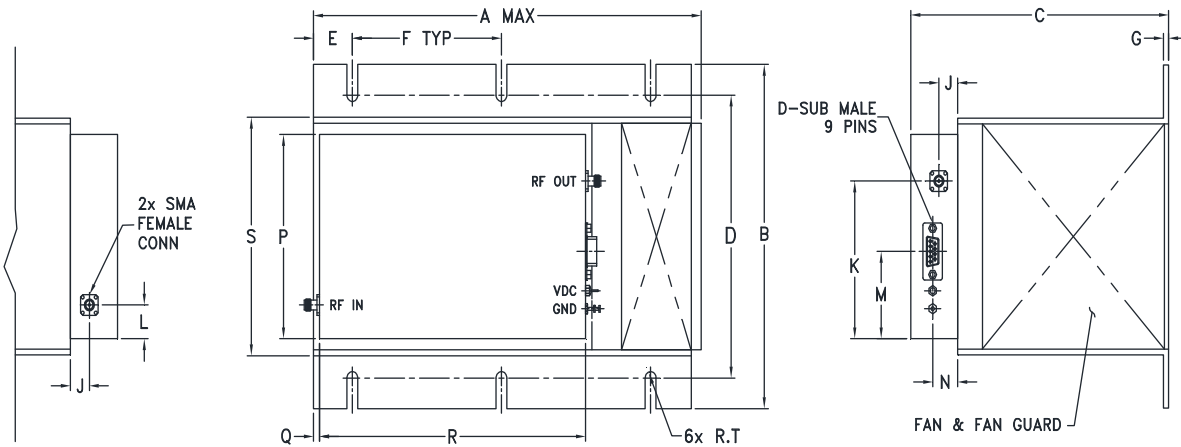

CASE STYLE DRAWING WITHOUT HEATSINK (ZHL-20M2G7025X+)

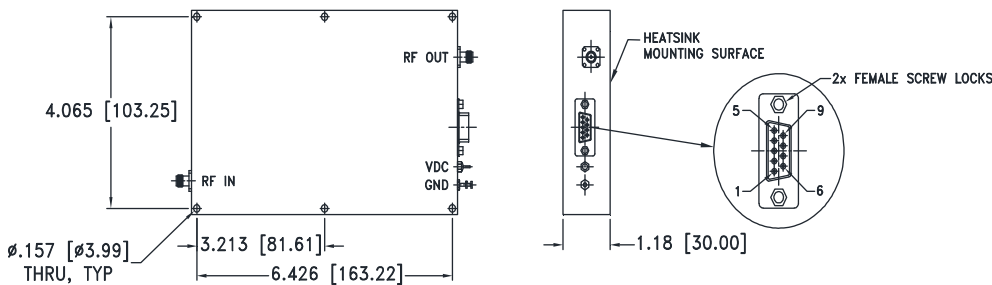

OUTLINE DIMENSIONS (Inch mm)

A	B	C	D	E	F	G	J	K	L	M	N	P	Q	R	S	T	wt
9.85	7.30	6.50	6.00	0.98	3.75	0.13	0.47	3.34	0.71	1.85	0.63	4.33	0.20	6.69	5.10	0.14	grams*
250.19	185.42	165.10	152.40	24.89	95.25	3.30	12.00	84.80	18.00	47.00	16.00	110.00	5.08	170.00	129.54	3.45	4565
																	*880 grams without heatsink

Tolerances: 1 Pl. +1; 2 Pl. +.03; 3 Pl. +.015





COAXIAL

High-Power Amplifier

ZHL-20M2G7025+
ZHL-20M2G7025X+

Mini-Circuits

50Ω 20 to 2700 MHz Broadband 25W SMA-Female

ADDITIONAL INFORMATION IS AVAILABLE ON OUR DASHBOARD.

Performance Data	Table
	Graphs
	S-Parameter (S2P Files) Data Set (.zip file)
RoHS Status	Compliant
Environmental Ratings	ENV162

ORDERING INFORMATION

Model No. Links	ZHL-20M2G7025+	ZHL-20M2G7025X+
Option	With heatsink	Without heatsink
Case Style	BT2119	
Connector	IN (SMA-Female) / OUT (SMA-Female)	

NOTES

- A. Performance and quality attributes and conditions not expressly stated in this specification document are intended to be excluded and do not form a part of this specification document.
- B. Electrical specifications and performance data contained in this specification document are based on Mini-Circuit's applicable established test performance criteria and measurement instructions.
- C. The parts covered by this specification document are subject to Mini-Circuits standard limited warranty and terms and conditions (collectively, "Standard Terms"); Purchasers of this part are entitled to the rights and benefits contained therein. For a full statement of the standard terms and the exclusive rights and remedies thereunder, please visit Mini-Circuits' website at www.minicircuits.com/terms/viewterm.html



Typical Performance Data

Frequency (MHz)	Gain	Isolation	Return Loss (dB)		P _{OUT} @ 1dB Compression	P _{OUT} @ 3dB Compression	P _{OUT} @ Saturation	OIP3	Noise Figure
	(dB)	(dB)	IN	OUT	(dBm)	(dBm)	(dBm)	(dBm)	(dB)
	28V	28V	28V	28V	28V	28V	28V	28V	28V
20	51.07	82.32	23.77	7.23	40.05	41.93	42.73	47.67	11.32
50	49.98	84.62	25.21	6.81	39.90	42.15	43.08	47.83	11.03
100	50.47	100.27	26.00	5.98	39.60	41.90	43.05	47.53	10.62
150	50.49	99.39	26.80	5.61	39.53	42.09	43.62	48.00	10.54
200	50.49	93.67	27.04	5.44	39.00	41.61	43.40	47.44	10.60
250	50.52	94.76	27.26	5.35	39.23	42.01	44.00	47.65	10.36
300	50.49	95.87	27.48	5.24	38.72	41.64	43.93	47.41	10.29
350	50.24	96.75	27.06	5.60	38.58	41.61	44.17	47.33	10.27
400	50.00	103.63	26.37	5.11	38.45	41.70	44.83	47.42	10.20
450	49.91	100.74	25.46	5.10	38.52	41.92	44.89	47.48	10.15
500	49.81	100.60	24.70	5.08	38.66	42.37	45.31	47.97	10.14
550	49.85	100.57	23.73	5.06	38.63	42.56	45.45	47.35	10.08
600	49.99	94.78	23.09	5.07	38.73	43.05	45.38	48.30	10.08
650	50.23	95.59	22.23	5.10	38.98	43.54	45.32	48.30	10.11
700	50.40	99.92	21.66	5.35	38.97	43.79	44.98	47.58	10.12
750	50.45	94.95	21.22	5.54	39.12	43.98	44.94	48.32	9.99
800	50.55	95.47	20.62	5.97	39.10	43.85	44.71	47.55	10.04
850	50.51	95.67	20.53	6.80	39.28	44.06	44.57	48.78	10.03
900	50.40	94.15	20.26	7.82	39.37	44.12	44.64	48.11	10.03
950	50.51	101.83	19.94	8.80	39.38	44.00	44.39	49.05	9.90
1000	50.62	93.21	19.92	10.04	39.51	43.93	44.56	48.14	9.99
1050	50.75	98.49	19.50	11.28	39.53	43.79	44.37	49.59	9.98
1100	50.87	101.17	19.38	12.58	39.65	43.56	44.36	48.45	10.00
1150	50.93	93.00	19.25	13.78	39.87	43.68	44.49	49.87	9.94
1200	50.90	95.83	19.42	14.91	40.24	44.02	45.03	48.40	9.93
1250	50.78	98.95	20.11	15.90	40.23	44.02	45.37	51.39	9.96
1300	50.55	94.47	21.09	17.07	40.27	44.08	45.91	48.32	9.91
1400	50.55	101.82	22.29	15.73	39.94	44.32	45.86	48.56	9.87
1500	50.80	93.63	21.07	13.09	39.96	44.36	45.38	48.64	9.85
1600	50.95	95.44	20.37	10.39	40.19	44.59	45.08	48.95	9.91
1700	50.67	91.13	21.56	8.67	40.29	44.76	44.91	48.99	9.84
1800	50.29	99.18	24.33	7.79	39.94	44.23	44.75	49.08	9.96
1900	49.95	96.74	26.40	7.69	39.56	43.89	44.43	48.85	9.91
2000	49.89	97.93	23.68	7.69	39.55	43.86	43.98	49.31	9.98
2100	50.02	94.67	21.42	7.54	39.82	43.74	43.76	49.45	10.00
2200	50.41	99.35	21.90	7.85	40.44	43.97	44.01	49.79	10.05
2300	50.60	100.18	24.96	9.66	41.07	44.63	44.66	50.27	10.08
2400	50.09	96.43	26.47	14.11	40.97	45.02	45.29	50.12	9.99
2500	49.77	101.35	25.64	18.31	40.66	44.69	45.74	50.00	10.21
2600	50.30	94.08	24.74	17.62	40.35	44.33	45.70	49.33	10.28
2700	50.53	97.07	25.48	9.44	39.74	43.72	45.06	47.17	10.23

Typical Performance Curves

Small Signal Gain vs. Frequency

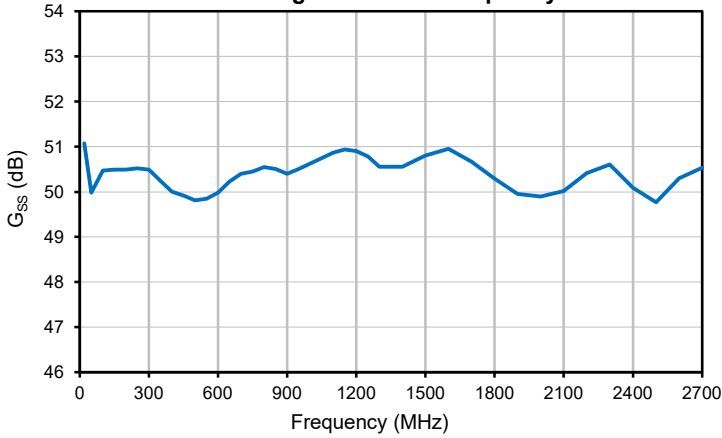

Isolation vs. Frequency

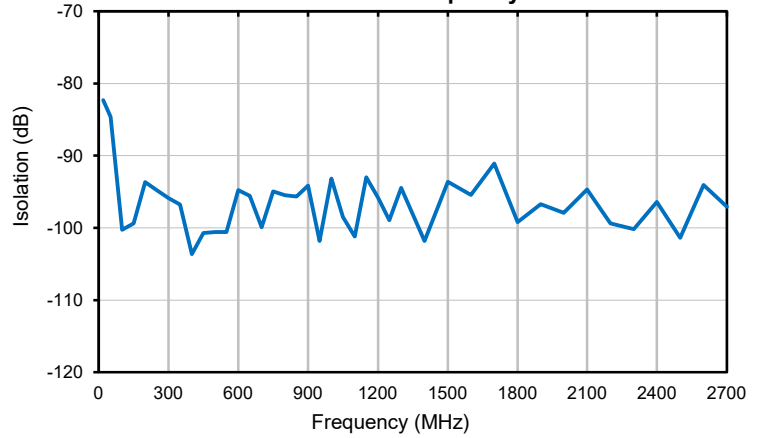

Input Return Loss vs. Frequency

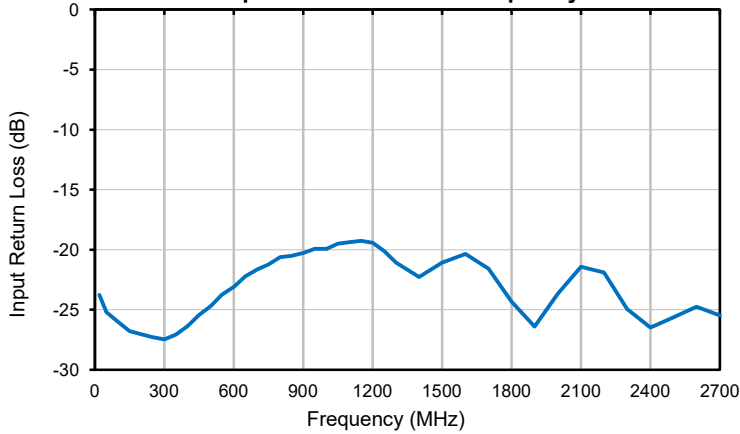

Output Return Loss vs. Frequency

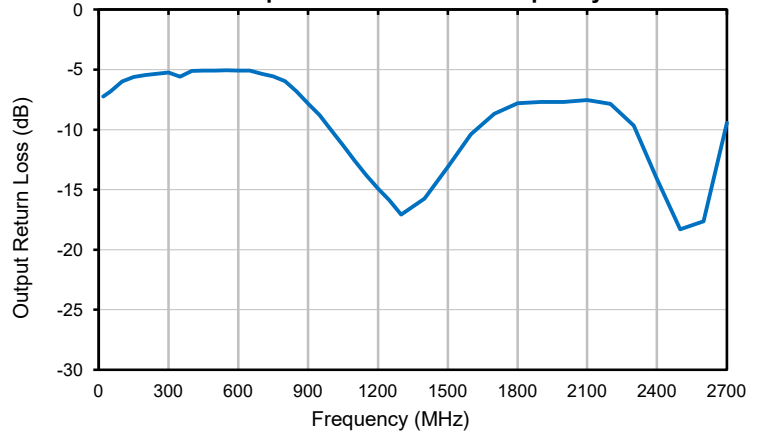

Output Power at 1 dB Compression vs. Frequency

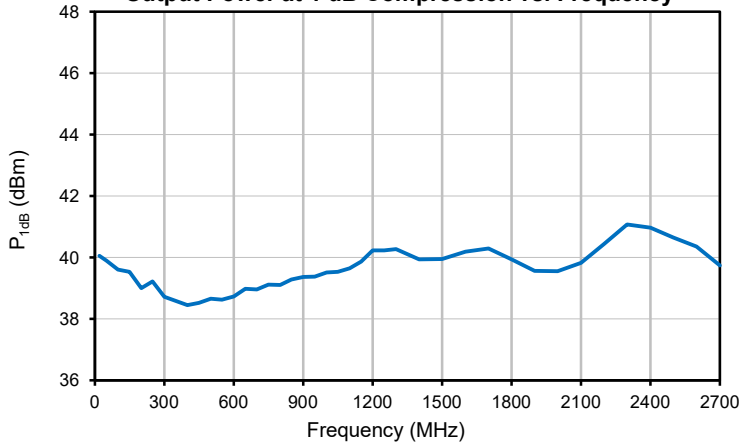

Output Power at 3 dB Compression vs. Frequency

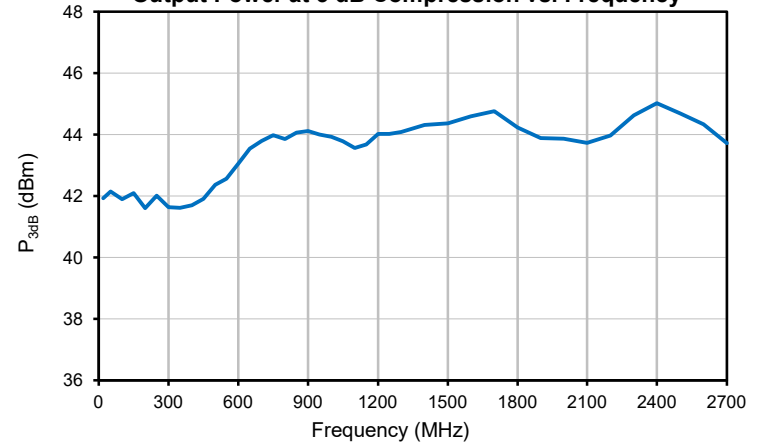

Typical Performance Curves

Output Power at Saturation vs. Frequency

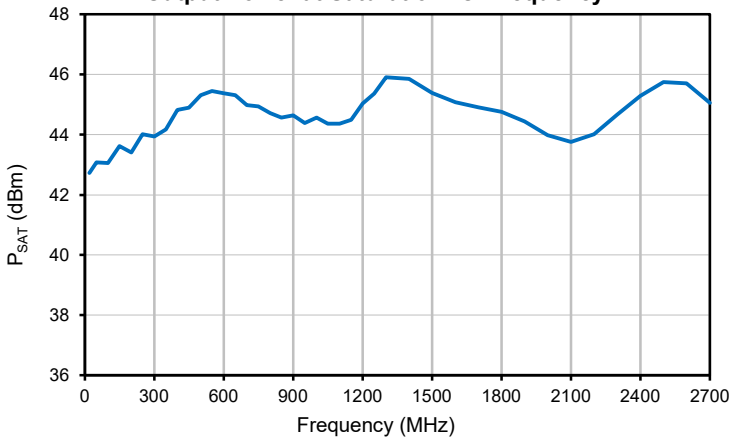

Output Third Order Intercept Point vs. Frequency

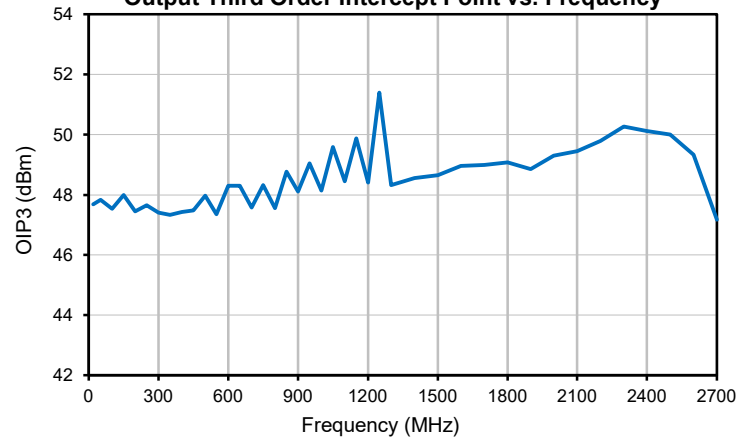

Noise Figure vs. Frequency

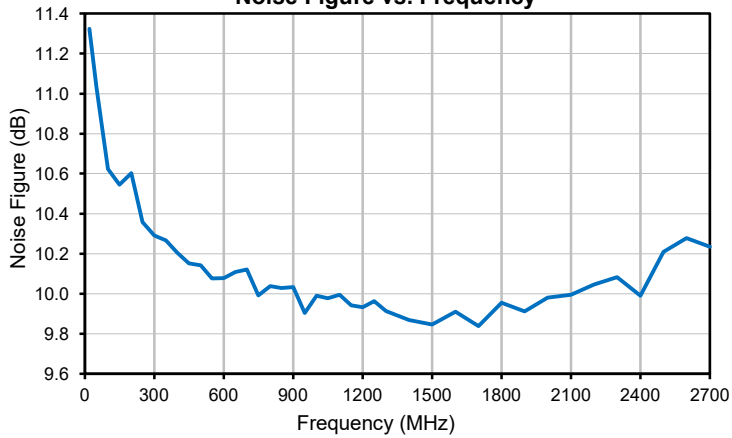

Outline Dimensions

BT2119

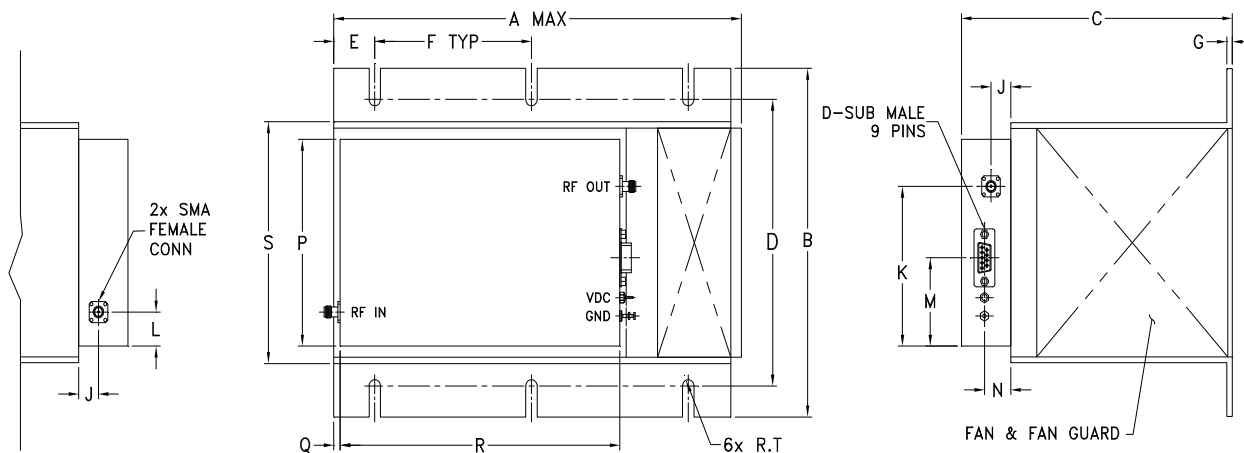

MOUNTING INFORMATION FOR MODELS WITHOUT HEATSINK.

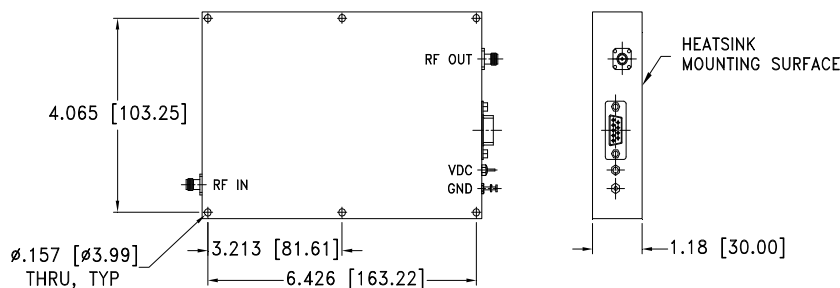

CASE#	A	B	C	D	E	F	G	H	J	K	L	M	N
BT2119	9.85 (250.19)	7.3 (185.42)	6.5 (165.10)	6.00 (152.40)	.98 (24.89)	3.75 (95.25)	.13 (3.30)	-	.47 (12.00)	3.34 (84.80)	.71 (18.00)	1.85 (47.00)	.63 (16.00)

CASE#	P	Q	R	S	T	WT, GRAM	WT WITHOUT HEATSINK, GRAM
BT2119	4.33 (110.00)	.2 (5.08)	6.69 (170.00)	5.1 (129.54)	.136 (3.45)	4565	880

Dimensions in inches (mm). Tolerances: 1 Pl. + .1; 2 Pl. + .03; 3 Pl. + .015

Notes:

- Case material: Aluminum alloy.
- Finish:
For RoHS Case Styles: Clear Chemical conversion coating, non-chrome or trivalent chrome based.
- Heatsink finish: Black anodize.
- Refer to the individual model data sheet for the type of connectors available.
- Recommended screws for mounting model without heat sink on 3/32" thick sheet: #6-32, 1.50" Length.
- Shape of connector flange may vary.



P.O. Box 350166, Brooklyn, New York 11235-0003 (718) 934-4500 Fax (718) 332-4661 For detailed performance specs & shopping online see Mini-Circuits web site



The Design Engineers Search Engine Provides ACTUAL Data Instantly From MINI-CIRCUITS At: www.minicircuits.com

RF/IF MICROWAVE COMPONENTS



All Mini-Circuits products are manufactured under exacting quality assurance and control standards, and are capable of meeting published specifications after being subjected to any or all of the following physical and environmental test.

Specification	Test/Inspection Condition	Reference/Spec
Operating Temperature	-20° to 45°C Ambient Environment	Individual Model Data Sheet
Storage Temperature	-55° to 100° C Ambient Environment	Individual Model Data Sheet
Stabilization Bake	(non-operating) 125°C, 24 hours	- - -
Burn-in at Elevated Temp.	(DC on) 160 hours at 60° C base plate Temperature	MIL-STD-202, Method 108
Thermal Shock	-55° to 100°C, 5 cycles	MIL-STD-202, Method 107, Condition A, except 100°C