



CAVITY

# Bandpass Filter ZVBP MODEL SERIES

50Ω DC to 57 GHz

## THE BIG DEAL

- Very low insertion loss with excellent power handling
- Very fast roll-off with wide stopband
- Passbands upto 36 GHz
- Stopband up to 57 GHz

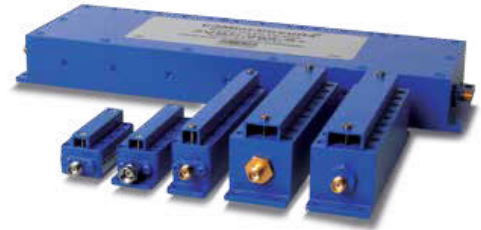

## PRODUCT OVERVIEW

Mini-Circuits' cavity filters are designed by implementing resonant structures with very high Q and are ideal for narrow-band, high-selectivity applications. These designs can provide bandwidths as narrow as 0.5% with very high selectivity and excellent low noise floor. Low insertion loss combined with excellent power handling makes them well-suited for transmitter and receiver front end. Advanced filter design and construction enables stopband width greater than 3x the center frequency.

Mini-Circuits' cavity filters feature a special protective assembly to prevent accidental de-tuning that would otherwise require expensive replacement or return to factory for re-tuning. Precise machining allows realization of cavity filters with small form factors for applications where size is critical. Excellent repeatability across units is achieved through precise tuning and process control.

## KEY FEATURES

Feature	Advantages
Low insertion loss	Low signal loss results in better SNR in receiver front end and better power delivery to antenna in transmitter.
Fast roll-off	Higher selectivity results in better adjacent channel rejection and dynamic range
Wide stopband	Wide spur free band results in better receiver sensitivity
High power handling	Well suited for transmitter application
Protective assembly	Prevents accidental de-tuning of precisely tuned resonant circuit





CAVITY

# Bandpass Filter

## ZVBP-3420-S+

Mini-Circuits

50Ω 3340 to 3500 MHz SMA-Female

### FEATURES

- Low Insertion loss, 1.5dB typ.
- Good Return loss, 20dB typ.
- Great Rejection (40 to 100 dB typ.)
- Stopband up to 6000 MHz



Generic photo used for illustration purposes only

### APPLICATIONS

- Test & Measurement Equipment
- Radar, EW, and ECM Defense Systems

Model No.	ZVBP-3420-S+
Case Style	YA3390
Connectors	SMA-FEMALE

**+RoHS Compliant**

The +Suffix identifies RoHS Compliance. See our web site for RoHS Compliance methodologies and qualifications

### ELECTRICAL SPECIFICATIONS AT 25°C

Parameter	F#	Frequency (MHz)	Min.	Typ.	Max.	Units
Passband	Center Frequency	Fc	-	3420	-	MHz
	Insertion Loss	F1-F2	-	1.5	2.0	dB
	Return Loss	F1-F2	3340 - 3500	14	20	dB
Stop Band, Lower	Rejection	DC-F3	DC - 3295	40	43	dB
		F3-F4	3295 - 3320	14	19	dB
Stop Band, Upper	Rejection	F5-F6	3520 - 3540	15	22	dB
		F6-F7	3540 - 6000	40	47	dB

### MAXIMUM RATINGS

Parameter	Ratings
Operating temperature	-40°C to +85°C
Storage temperature	-55°C to +100°C
RF Power Input	20W max. at 25°C

Permanent damage may occur if any of these limits are exceeded  
Input and output ports are DC short to ground.

### TYPICAL FREQUENCY RESPONSE

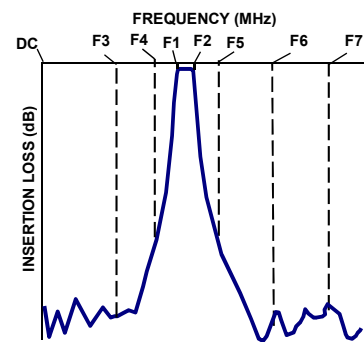

### FUNCTIONAL SCHEMATIC

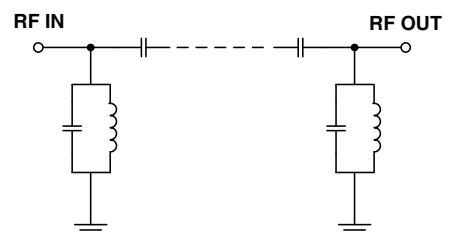

Mini-Circuits



CAVITY

# Bandpass Filter

## ZVBP-3420-S+

### COAXIAL CONNECTIONS

PORT 1	SMA-Female
PORT 2	SMA-Female

### OUTLINE DRAWING

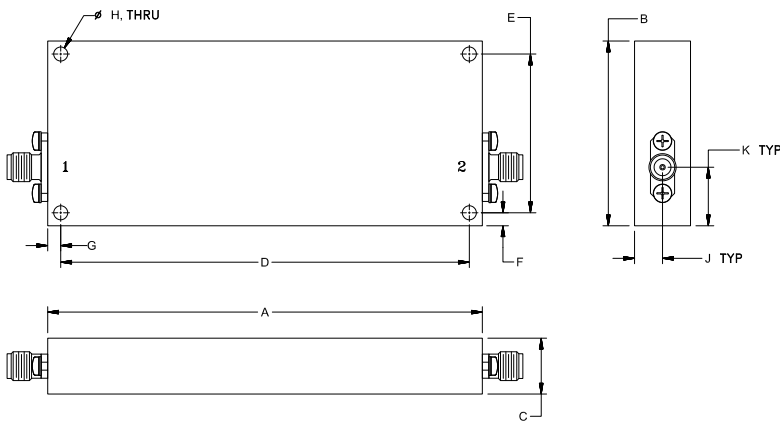

### OUTLINE DIMENSIONS (Inches/mm)

A	B	C	D	E	F
<b>4.00</b>	<b>1.70</b>	<b>.51</b>	<b>3.760</b>	<b>1.460</b>	<b>.12</b>
101.6	43.2	13.1	95.50	37.08	3.0
G	H	J	K		Wt.
<b>.12</b>	<b>.130</b>	<b>.26</b>	<b>.55</b>		grams
3.0	3.30	6.5	14.0		220

Note. Please refer to case style drawing for details



CAVITY

# Bandpass Filter

## ZVBP-3420-S+

### TYPICAL PERFORMANCE DATA AT 25°C

Frequency (MHz)	Insertion Loss (dB)	Return Loss (dB)	Frequency (MHz)	GROUP DELAY (ns)
100	116.41	0.05	3340	26.36
1000	112.14	0.10	3350	19.38
3295	43.65	0.37	3360	16.70
3310	30.59	0.51	3370	15.34
3320	19.41	0.82	3380	14.42
3333	3.03	8.27	3390	13.91
3340	1.37	24.01	3400	13.63
3420	0.78	28.64	3410	13.45
3500	1.49	21.19	3420	13.50
3508	3.42	9.06	3430	13.66
3520	22.57	0.79	3440	13.94
3525	29.71	0.56	3450	14.49
3540	46.81	0.30	3460	15.18
5000	112.17	0.21	3480	17.98
6000	103.87	0.21	3500	27.99

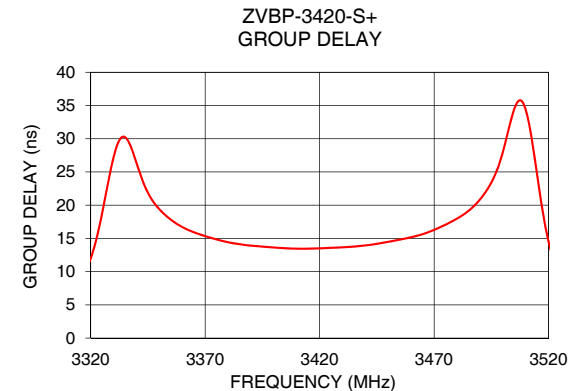
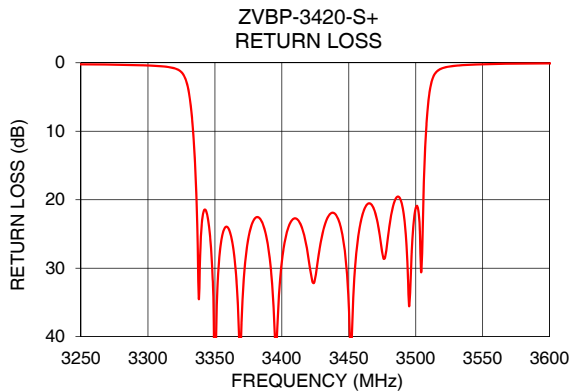
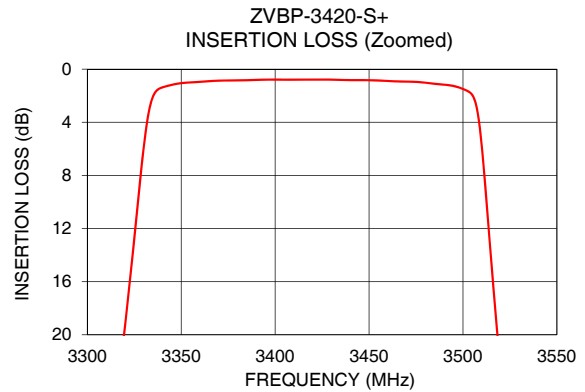
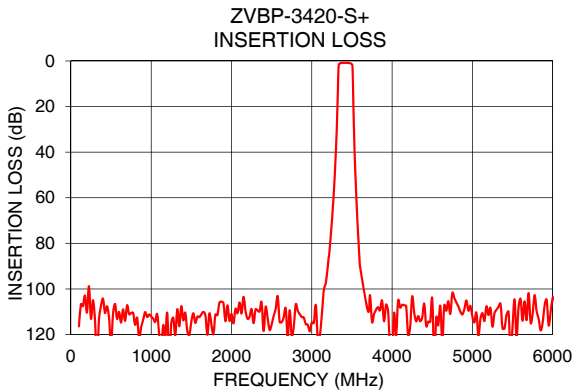

- NOTES**
- A. Performance and quality attributes and conditions not expressly stated in this specification document are intended to be excluded and do not form a part of this specification document.
  - B. Electrical specifications and performance data contained in this specification document are based on Mini-Circuit's applicable established test performance criteria and measurement instructions.
  - C. The parts covered by this specification document are subject to Mini-Circuits standard limited warranty and terms and conditions (collectively, "Standard Terms"); Purchasers of this part are entitled to the rights and benefits contained therein. For a full statement of the standard. Terms and the exclusive rights and remedies thereunder, please visit Mini-Circuits' website at [www.minicircuits.com/MCLStore/terms.jsp](http://www.minicircuits.com/MCLStore/terms.jsp)



Typical Performance Data

FREQ.  (MHz)	INSERTION LOSS			INPUT RETURN LOSS			OUTPUT RETURN LOSS		
	(dB)			(dB)			(dB)		
	@-40°C	@+25°C	@+85°C	@-40°C	@+25°C	@+85°C	@-40°C	@+25°C	@+85°C
100	99.04	116.41	107.89	0.04	0.05	0.05	0.06	0.07	0.08
200	106.26	110.36	129.46	0.05	0.07	0.07	0.08	0.09	0.10
300	106.60	113.51	107.76	0.06	0.08	0.09	0.08	0.10	0.11
400	111.92	104.28	106.58	0.08	0.09	0.10	0.10	0.11	0.13
500	121.57	124.44	105.36	0.08	0.10	0.12	0.10	0.11	0.13
600	113.19	110.13	104.25	0.08	0.10	0.12	0.09	0.11	0.13
700	114.14	107.16	112.49	0.08	0.11	0.12	0.10	0.12	0.14
800	113.15	115.73	120.92	0.08	0.11	0.13	0.09	0.11	0.13
900	127.97	113.55	110.14	0.08	0.10	0.12	0.08	0.11	0.13
1000	113.62	112.14	115.90	0.07	0.10	0.12	0.07	0.10	0.12
1200	109.50	110.59	108.32	0.06	0.09	0.11	0.06	0.09	0.11
1400	111.41	113.78	113.16	0.04	0.08	0.10	0.04	0.08	0.10
1600	119.22	112.41	127.86	0.04	0.08	0.11	0.04	0.08	0.11
1800	120.79	111.27	114.93	0.04	0.08	0.11	0.03	0.07	0.11
2000	107.95	111.00	107.16	0.04	0.09	0.12	0.03	0.08	0.11
2200	110.33	113.10	113.35	0.04	0.09	0.13	0.04	0.09	0.13
2300	112.34	108.97	117.16	0.05	0.10	0.14	0.04	0.09	0.13
2400	111.53	118.44	109.41	0.05	0.10	0.15	0.05	0.10	0.14
2500	114.52	115.62	116.82	0.05	0.11	0.15	0.05	0.11	0.15
2700	110.17	121.33	111.76	0.05	0.11	0.16	0.05	0.11	0.16
3000	114.44	114.69	107.27	0.06	0.12	0.18	0.06	0.12	0.17
3295	46.07	43.65	41.21	0.29	0.37	0.44	0.26	0.34	0.41
3310	33.73	30.59	27.35	0.40	0.51	0.63	0.37	0.48	0.59
3320	23.35	19.41	15.27	0.58	0.82	1.18	0.54	0.76	1.12
3327	14.45	9.91	5.79	1.03	1.92	4.11	0.97	1.83	3.96
3333	6.09	3.03	1.89	3.25	8.27	19.58	3.14	7.95	17.74
3340	1.43	1.37	1.37	23.20	24.01	22.33	20.19	21.88	21.69
3360	0.84	0.95	1.03	23.87	24.16	27.03	23.78	24.08	27.17
3380	0.72	0.85	0.95	24.14	22.70	22.36	24.12	22.60	22.15
3400	0.66	0.79	0.89	41.78	29.03	24.82	38.51	29.29	25.00
3420	0.67	0.78	0.89	24.69	28.64	32.68	25.19	30.35	42.25
3440	0.69	0.83	0.94	22.20	22.12	23.57	22.28	21.85	22.69
3460	0.73	0.89	1.03	26.73	22.35	20.99	23.83	21.38	20.61
3480	0.83	1.02	1.21	28.41	24.36	20.83	53.43	26.16	21.27
3500	1.13	1.49	1.97	30.36	21.19	28.80	29.23	20.87	24.79
3508	1.60	3.42	8.88	34.10	9.06	2.97	26.38	8.76	2.86
3513	4.51	10.76	17.61	5.73	2.10	1.21	5.58	2.02	1.16
3520	16.33	22.57	28.25	1.05	0.79	0.68	1.00	0.75	0.65
3525	24.29	29.71	34.72	0.60	0.56	0.54	0.58	0.53	0.52
3540	42.80	46.81	50.67	0.25	0.30	0.34	0.24	0.29	0.33
3560	60.97	64.21	67.25	0.11	0.17	0.23	0.11	0.17	0.23
3600	87.94	90.01	91.90	0.02	0.09	0.16	0.02	0.10	0.16
3700	104.61	109.80	119.33	0.03	0.05	0.11	0.02	0.05	0.11
3800	124.42	109.15	104.61	0.04	0.03	0.10	0.03	0.04	0.10
3900	108.74	114.19	111.77	0.04	0.03	0.10	0.03	0.04	0.10
4000	110.24	129.05	108.93	0.04	0.04	0.10	0.03	0.04	0.10
4100	106.45	108.19	111.94	0.03	0.04	0.10	0.02	0.05	0.11
4200	107.71	120.35	107.55	0.02	0.05	0.11	0.01	0.06	0.12
4300	105.04	114.21	111.85	0.01	0.07	0.13	0.01	0.08	0.13
4400	104.64	106.45	114.99	0.01	0.08	0.14	0.03	0.09	0.14
4500	108.97	104.19	106.15	0.03	0.10	0.16	0.04	0.11	0.16
4600	111.72	107.41	116.63	0.05	0.12	0.17	0.07	0.13	0.18
4700	107.99	105.42	121.60	0.07	0.14	0.20	0.09	0.15	0.20
4800	120.53	105.87	116.26	0.10	0.17	0.22	0.11	0.17	0.22
4900	123.17	108.86	109.07	0.12	0.19	0.24	0.13	0.19	0.24
5000	111.96	112.17	110.37	0.14	0.21	0.26	0.14	0.20	0.25
5100	124.98	113.07	105.19	0.16	0.23	0.28	0.15	0.21	0.26
5200	112.70	111.45	108.76	0.18	0.24	0.29	0.16	0.22	0.27
5500	105.18	116.59	110.50	0.20	0.26	0.30	0.18	0.23	0.28
6000	106.94	103.87	107.80	0.15	0.21	0.25	0.08	0.14	0.18

## Typical Performance Data

FREQ.  (MHz)	GROUP DELAY		
	(nsec)		
	@-40°C	@+25°C	@+85°C
3340	29.65	26.36	23.21
3342	27.86	24.31	21.73
3344	25.71	22.57	20.60
3346	23.69	21.23	19.70
3348	22.07	20.20	18.97
3350	20.84	19.38	18.33
3352	19.89	18.69	17.78
3354	19.13	18.09	17.30
3356	18.47	17.56	16.88
3358	17.89	17.10	16.52
3360	17.38	16.70	16.21
3362	16.94	16.36	15.94
3364	16.56	16.06	15.69
3366	16.23	15.80	15.46
3370	15.70	15.34	15.04
3375	15.15	14.84	14.59
3380	14.67	14.42	14.24
3385	14.29	14.12	14.01
3390	14.01	13.91	13.86
3395	13.83	13.77	13.72
3400	13.70	13.63	13.59
3405	13.57	13.52	13.50
3410	13.47	13.45	13.48
3415	13.41	13.45	13.53
3420	13.43	13.50	13.60
3425	13.49	13.58	13.68
3430	13.57	13.66	13.78
3435	13.66	13.77	13.92
3440	13.78	13.94	14.15
3445	13.97	14.18	14.44
3450	14.23	14.49	14.77
3455	14.54	14.81	15.13
3460	14.87	15.18	15.56
3465	15.26	15.64	16.15
3470	15.76	16.28	16.91
3475	16.44	17.07	17.80
3480	17.26	17.98	18.88
3485	18.21	19.14	20.42
3490	19.48	20.85	22.75
3495	21.37	23.42	26.65
3500	24.25	27.99	33.08

## Typical Performance Curves

**INSERTION LOSS vs. TEMPERATURE**  
INPUT POWER = 0 dBm

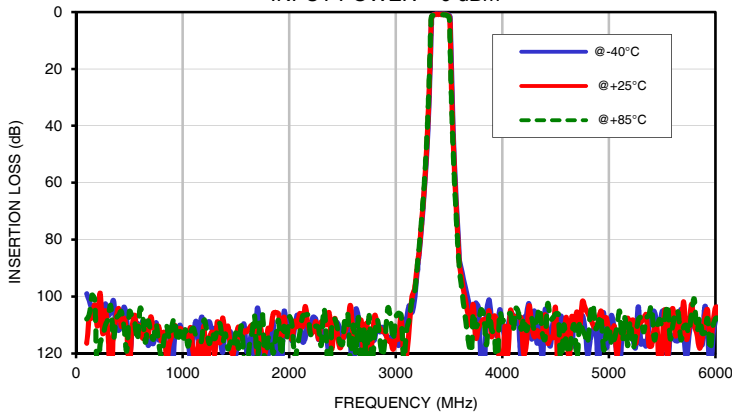

**INSERTION LOSS vs. TEMPERATURE (Zoomed)**  
INPUT POWER = 0 dBm

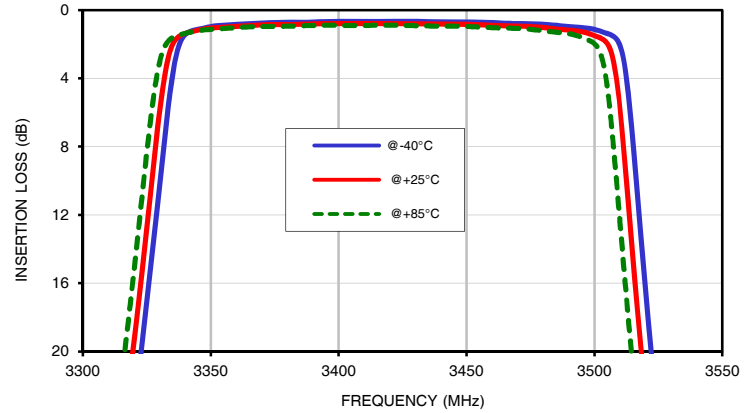

**INPUT RETURN LOSS vs. TEMPERATURE**  
INPUT POWER = 0 dBm

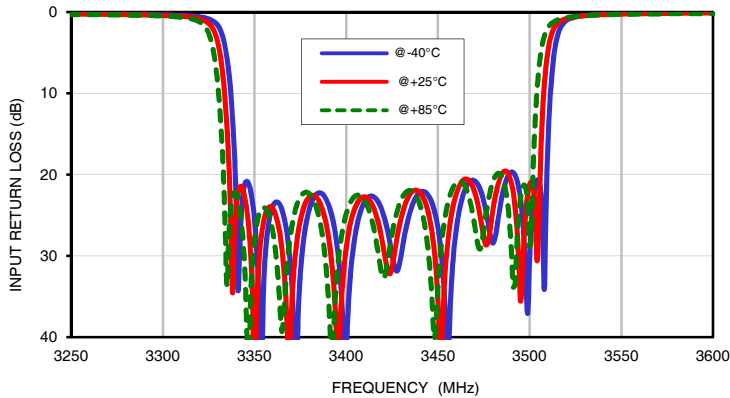

**OUTPUT RETURN LOSS vs. TEMPERATURE**  
INPUT POWER = 0 dBm

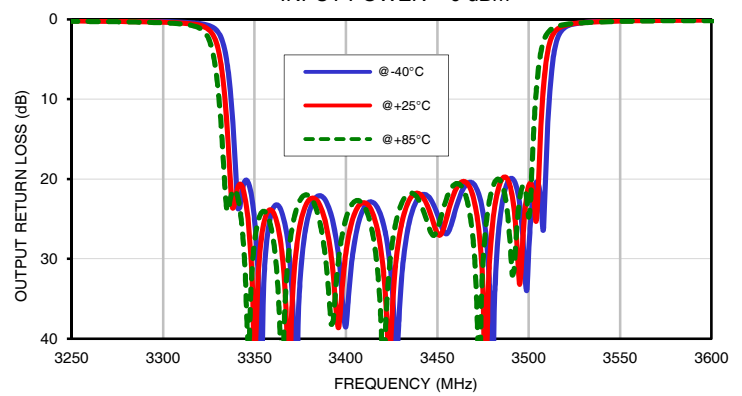

**GROUP DELAY vs. TEMPERATURE**  
INPUT POWER = 0 dBm

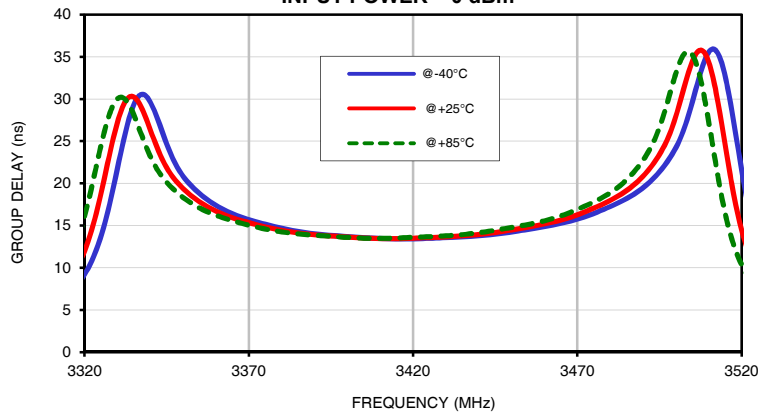

## Outline Dimensions

YA3390

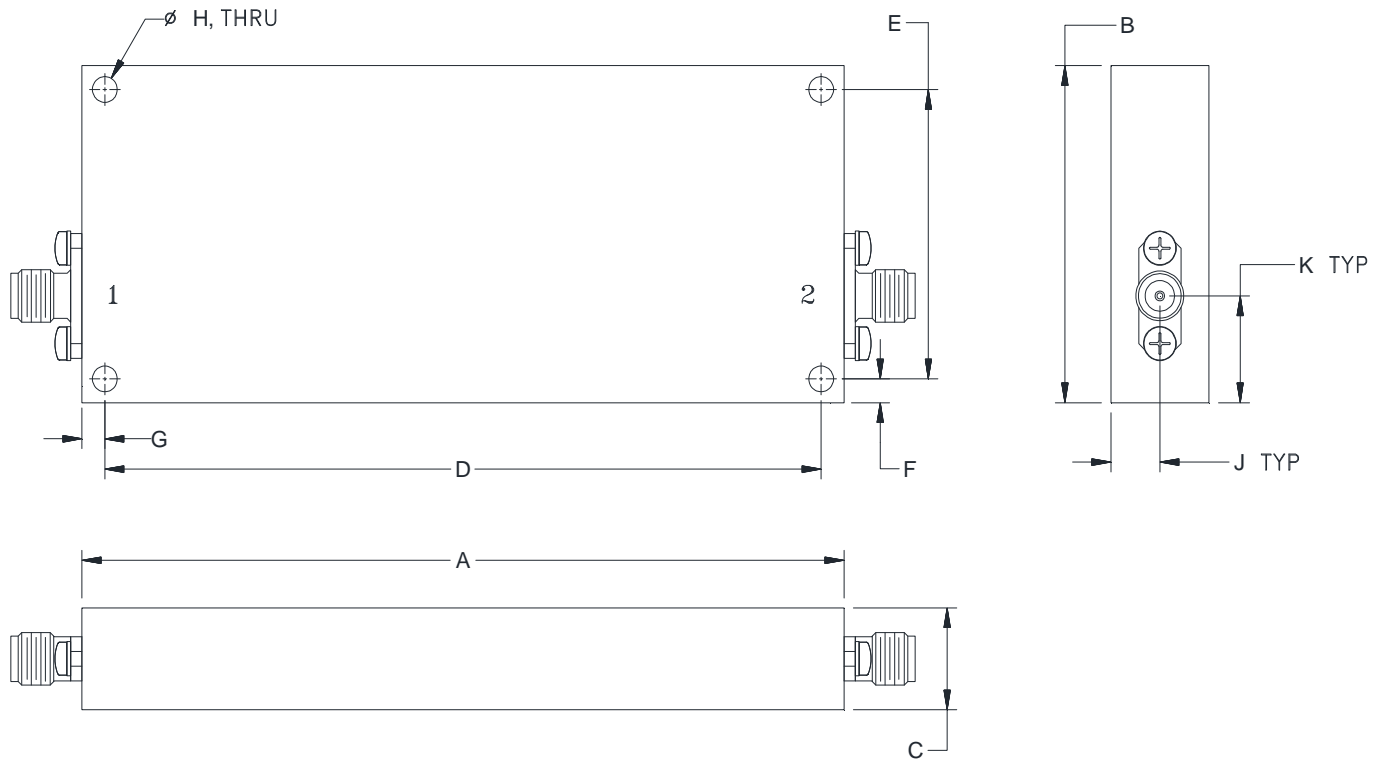

CASE#	A	B	C	D	E	F
YA3390	4.00 (101.6)	1.70 (43.2)	.51 (13.1)	3.760 (95.50)	1.460 (37.08)	.12 (3.0)

CASE#	G	H	J	K	WT. GRAMS
YA3390	.12 (3.0)	.130 (3.30)	.26 (6.5)	.55 (14.0)	220

Dimensions are in inches (mm). Tolerances: 2 Pl.  $\pm .100$ ; 3 Pl.  $\pm .015$

### Notes:

1. Case material: Brass.
2. Case Finish: Powder coated over silver plating.
3. Refer to the individual model data sheet for the type of connectors available.



P.O. Box 350166, Brooklyn, New York 11235-0003 (718) 934-4500 Fax (718) 332-4661 For detailed performance specs & shopping online see Mini-Circuits web site



The Design Engineers Search Engine Provides ACTUAL Data Instantly From MINI-CIRCUITS At: [www.minicircuits.com](http://www.minicircuits.com)

RF/IF MICROWAVE COMPONENTS



All Mini-Circuits products are manufactured under exacting quality assurance and control standards, and are capable of meeting published specifications after being subjected to any or all of the following physical and environmental test.

Specification	Test/Inspection Condition	Reference/Spec
Operating Temperature	-55° to 100°C Ambient Environment	Individual Model Data Sheet
Storage Temperature	-55° to 100° C Ambient Environment	Individual Model Data Sheet
Humidity	90 to 95% RH, 40°C, 96 hours; Units may require bake-out after humidity to restore full performance.	MIL-STD-202, Method 103, Condition B
Thermal Shock	-55° to 100°C, 100 cycles	MIL-STD-202, Method 107, Condition A-3, except +100°C
Vibration (High Frequency)	20g peak, 10-2000 Hz, 12 times in each of three perpendicular directions (total 36)	MIL-STD-202, Method 204, Condition D
Mechanical Shock	50g, 11ms half-sine, 3 shocks each direction 3 axes (total 18)	MIL-STD-202, Method 213, Condition A