

Evaluation Board and Circuit

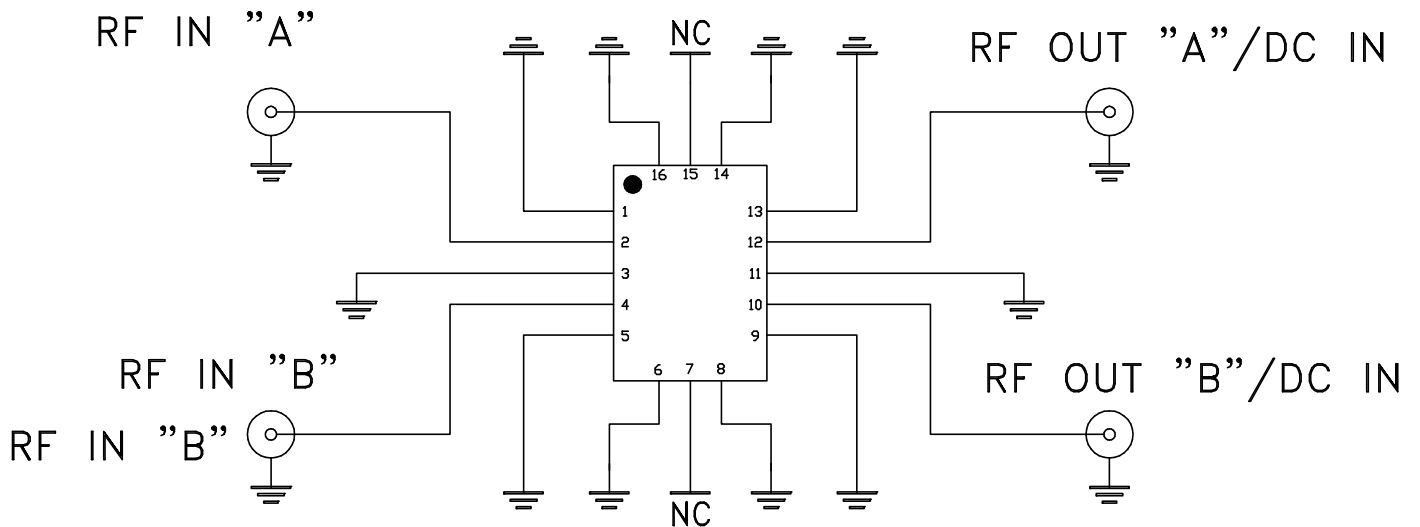
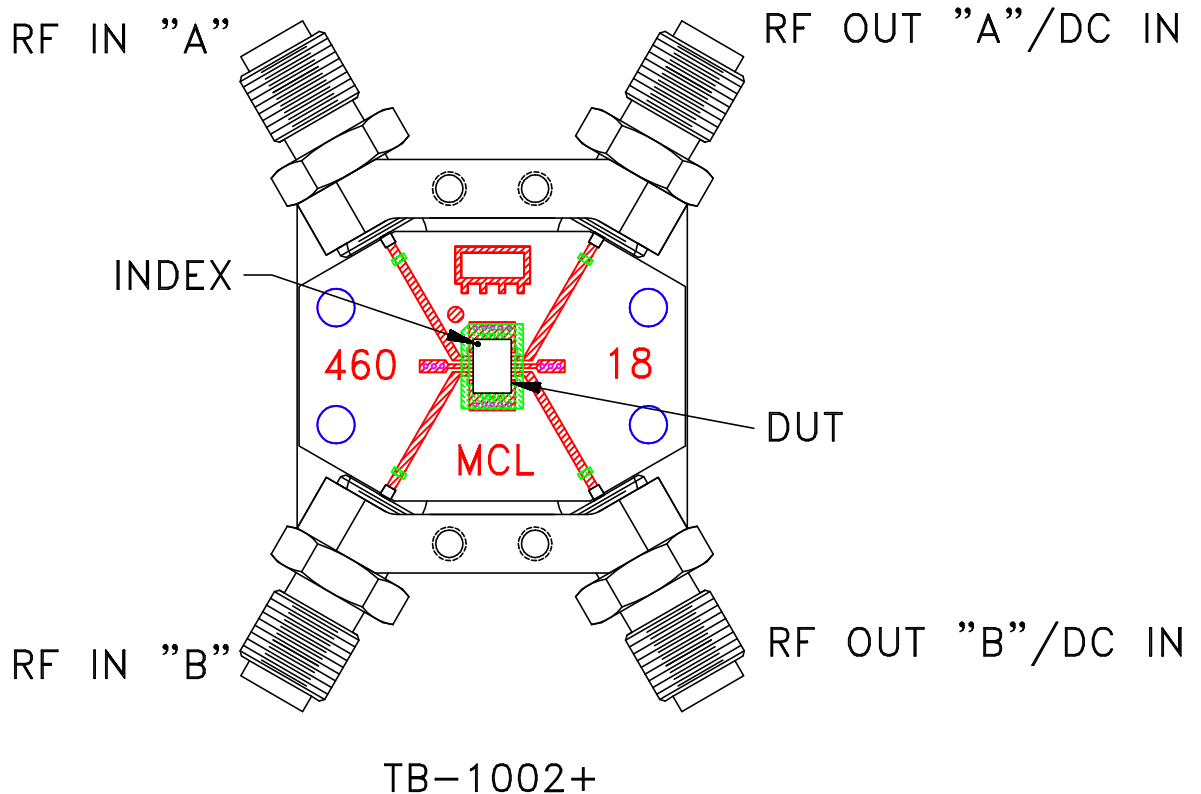

Schematic Diagram

NOTES:

1. SMA Female connectors.
2. PCB Material: Rogers R04350 or equivalent, Dielectric Constant=3.5, Thickness=.010 inch.

