

# Evaluation Board and Circuit

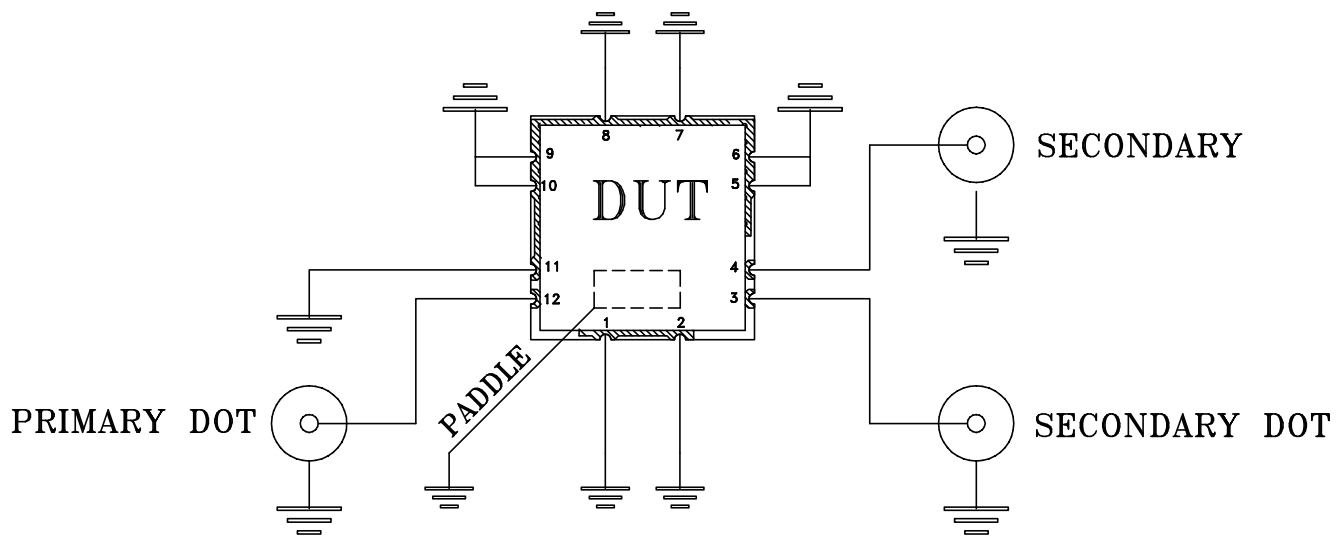
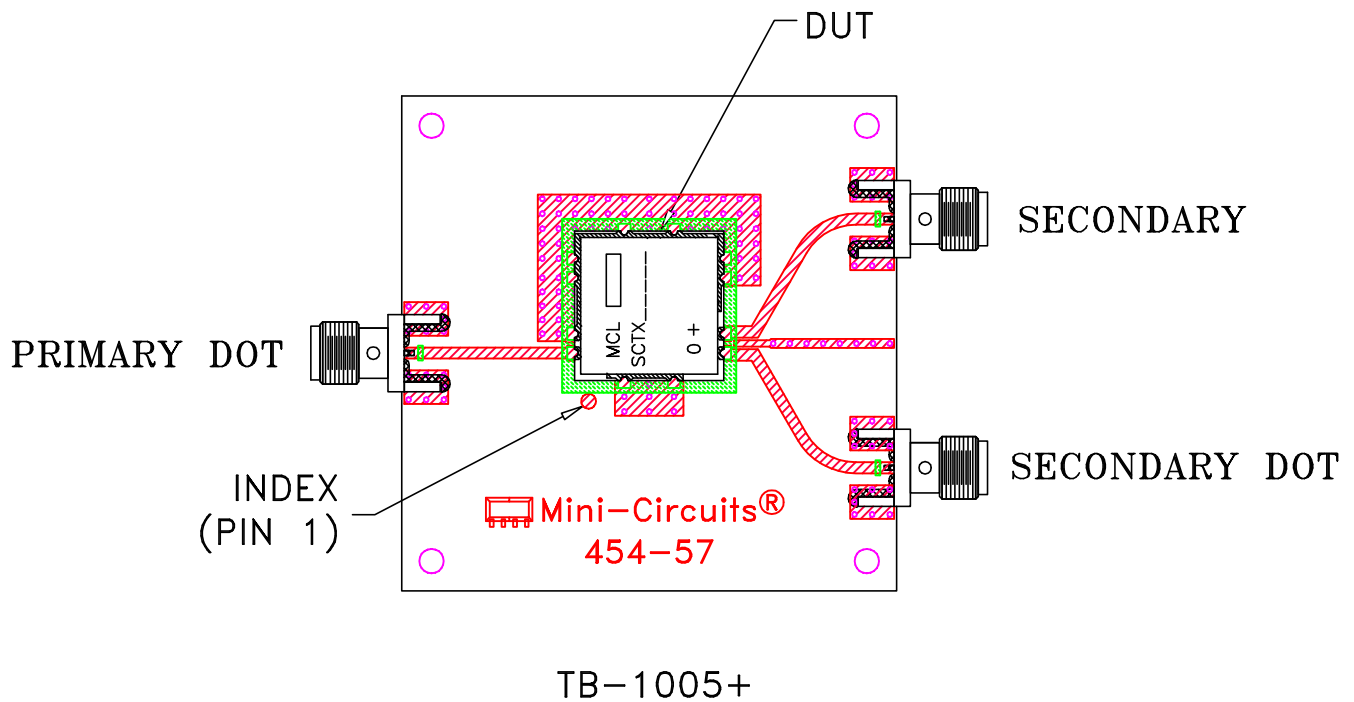

Schematic Diagram

**Notes:**

1. 50 Ohm SMA Female connectors.
2. PCB Material: R04350 or equivalent, Dielectric Constant=3.5, Thickness=.020 inch.

